

Silicon NPN Power Transistors

2SD1426

DESCRIPTION

www.datasheet4u.com

- With TO-3PH package
- Built-in damper diode
- High voltage ,high speed
- Low collector saturation voltage

APPLICATIONS

- Designed for use in color TV deflection circuits

PINNING

PIN	DESCRIPTION
1	Base
2	Collector;connected to mounting base
3	Emitter

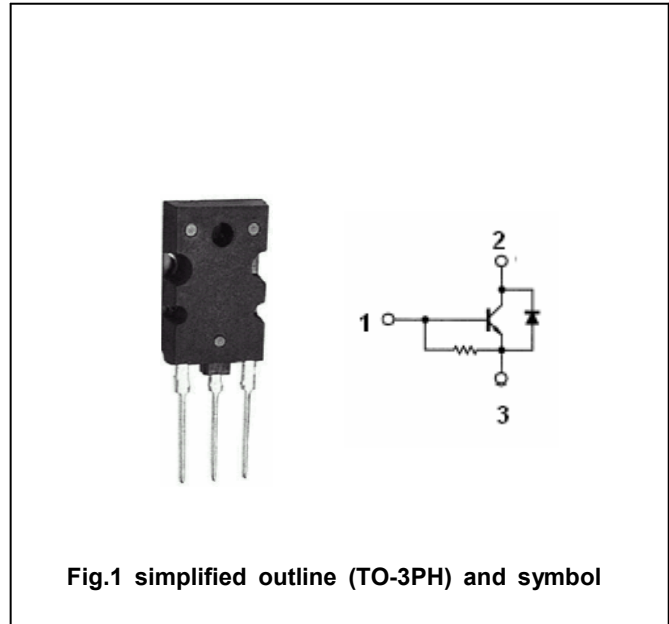

Fig.1 simplified outline (TO-3PH) and symbol

Absolute maximum ratings (Ta=25°C)

SYMBOL	PARAMETER	CONDITIONS	VALUE	UNIT
V _{CBO}	Collector-base voltage	Open emitter	1500	V
V _{CEO}	Collector-emitter voltage	Open base	600	V
V _{EBO}	Emitter-base voltage	Open collector	5	V
I _C	Collector current		3.5	A
I _B	Base current		1.0	A
P _D	Total power dissipation	T _C =25°C	80	W
T _j	Junction temperature		150	°C
T _{stg}	Storage temperature		-55~150	°C

THERMAL CHARACTERISTICS

SYMBOL	PARAMETER	MAX	UNIT
R _{th j-c}	Thermal resistance junction case	1.56	°C/W

Silicon NPN Power Transistors

2SD1426

CHARACTERISTICS

T_j=25°C unless otherwise specified

www.datasheet4u.com

SYMBOL	PARAMETER	CONDITIONS	MIN	TYP.	MAX	UNIT
V _{(BR)EBO}	Emitter-base breakdown voltage	I _E =200mA; I _C =0	5			V
V _{CEsat}	Collector-emitter saturation voltage	I _C =3A; I _B =0.8A			8.0	V
V _{BEsat}	Base-emitter saturation voltage	I _C =3A; I _B =0.8A			1.5	V
I _{CBO}	Collector cut-off current	V _{CB} =500V; I _E =0			10	μA
h _{FE}	DC current gain	I _C =0.5A; V _{CE} =5V	8			
f _T	Transition frequency	I _C =0.1A; V _{CE} =10V; f=1MHz		3		MHz
C _{OB}	Output capacitance	I _E =0; V _{CB} =10V; f=1.0MHz		95		pF
V _F	Diode forward voltage	I _F =3.5A			2.0	V
t _f	Fall time	I _C =3A; I _{B1} =0.8A			1.0	μs

Silicon NPN Power Transistors

2SD1426

PACKAGE OUTLINE

www.datasheet4u.com

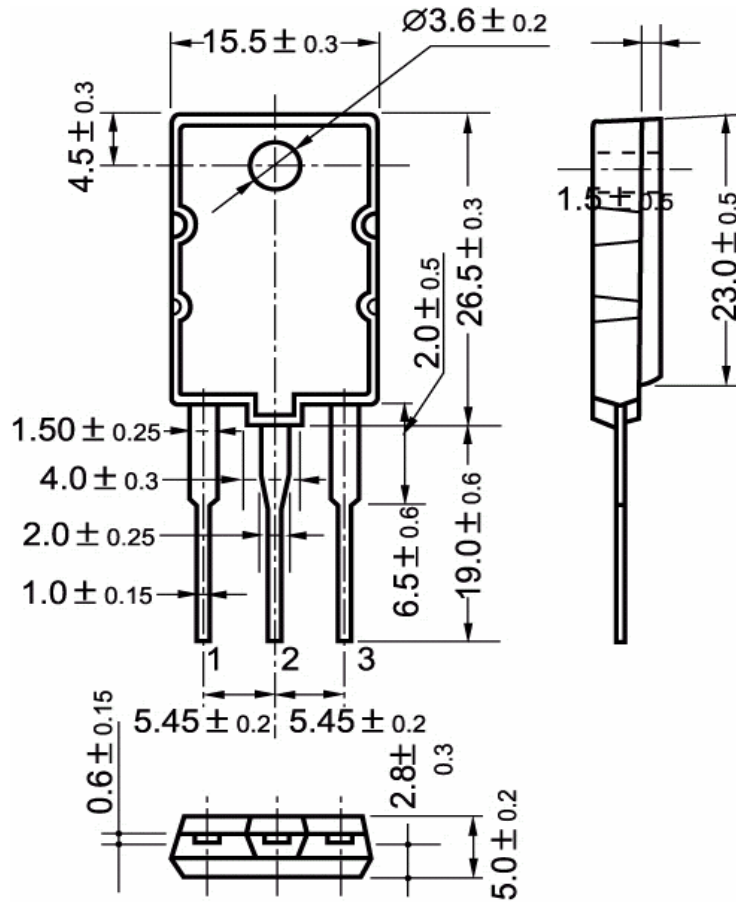

Fig.2 outline dimensions