



2SD1628

Bipolar Transistor 20V, 5A, Low VCE(sat), NPN Single PCP

ON Semiconductor®

<http://onsemi.com>

Applications

- Strobe DC-DC converters, relay drivers, hammer drivers, lamp drivers, motor drivers

Features

- Low saturation voltage
- Large current capacity
- Very small size making it easy to provide highdensity, small-sized hybrid IC's
- Halogen free compliance
- High hFE

Specifications

Absolute Maximum Ratings at Ta=25°C

Parameter	Symbol	Conditions	Ratings	Unit
Collector-to-Base Voltage	V _{CBO}		60	V
Collector-to-Emitter Voltage	V _{CEO}		20	V
Emitter-to-Base Voltage	V _{EBO}		6	V
Collector Current	I _C		5	A
Collector Current (Pulse)	I _{CP}		8	A

Continued on next page.

Package Dimensions

unit : mm (typ)

7007B-004

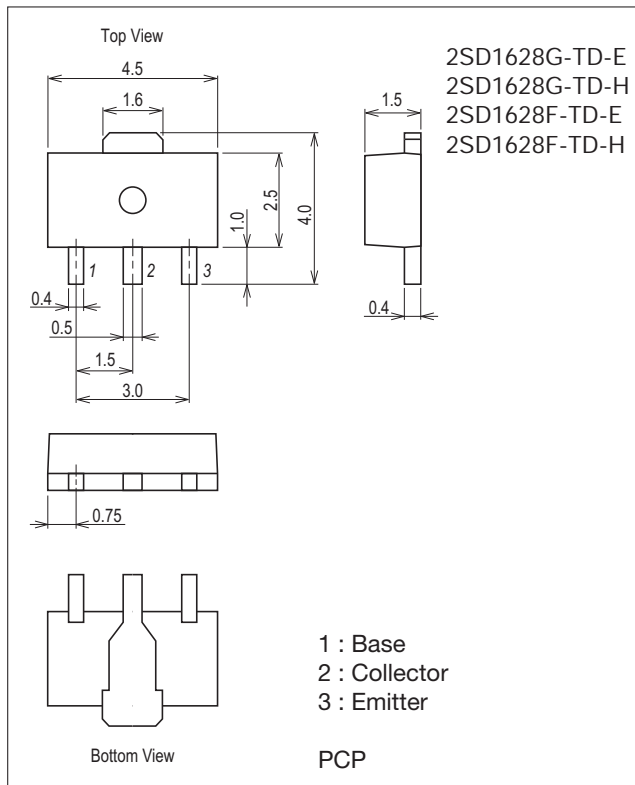

Product & Package Information

- Package : PCP
- JEITA, JEDEC : SC-62, SOT-89, TO-243
- Minimum Packing Quantity : 1,000 pcs./reel

Packing Type: TD

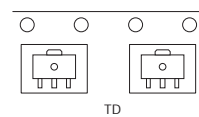

Marking

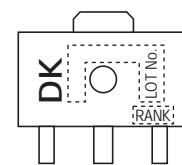

Electrical Connection

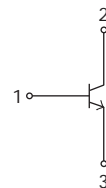

2SD1628

Continued from preceding page.

Parameter	Symbol	Conditions	Ratings	Unit
Collector Dissipation	PC		500	mW
		When mounted on ceramic substrate (250mm ² ×0.8mm)	1.5	W
Junction Temperature	Tj		150	°C
Storage Temperature	Tstg		-55 to +150	°C

Stresses exceeding Maximum Ratings may damage the device. Maximum Ratings are stress ratings only. Functional operation above the Recommended Operating Conditions is not implied. Extended exposure to stresses above the Recommended Operating Conditions may affect device reliability.

Electrical Characteristics at Ta=25°C

Parameter	Symbol	Conditions	Ratings			Unit
			min	typ	max	
Collector Cutoff Current	ICBO	V _{CB} =50V, I _E =0A			100	nA
Emitter Cutoff Current	IEBO	V _{EB} =5V, I _C =0A			100	nA
DC Current Gain	h _{FE1}	V _{CE} =2V, I _C =0.5A	120*		560*	
	h _{FE2}	V _{CE} =2V, I _C =3A	95			
Gain-Bandwidth Product	f _T	V _{CE} =10V, I _C =50mA		120		MHz
Output Capacitance	Cob	V _{CB} =10V, f=1MHz		45		pF
Collector-to-Emitter Saturation Voltage	V _{CE(sat)}	I _C =3A, I _B =60mA			500	mV
Base-to-Emitter Saturation Voltage	V _{BE(sat)}	I _C =3A, I _B =60mA			1.5	V
Turn-ON Time	t _{on}	See specified Test Circuit.		30		ns
Storage Time	t _{stg}			300		ns
Fall Time	t _f			40		ns

* : The 2SD1628 is classified by 0.5A h_{FE} as follows :

Rank	E	F	G
h _{FE}	120 to 200	160 to 320	280 to 560

Switching Time Test Circuit

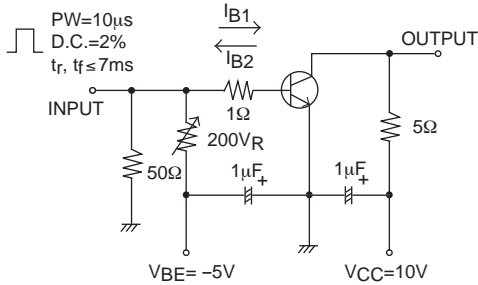

$$I_C = 10I_{B1} = -10I_{B2} = 2A$$

Ordering Information

Device	Package	Shipping	memo
2SD1628G-TD-E	PCP	1,000pcs./reel	Pb Free
2SD1628G-TD-H	PCP	1,000pcs./reel	Pb Free and Halogen Free
2SD1628F-TD-E	PCP	1,000pcs./reel	Pb Free
2SD1628F-TD-H	PCP	1,000pcs./reel	Pb Free and Halogen Free

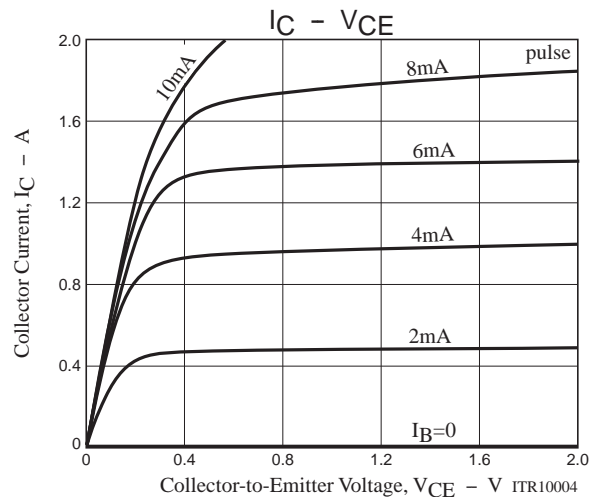
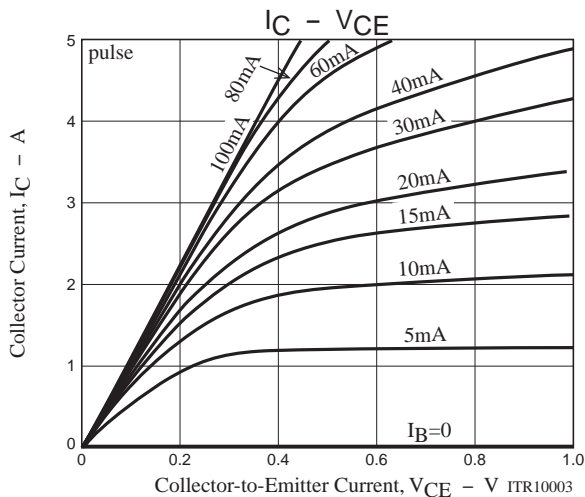

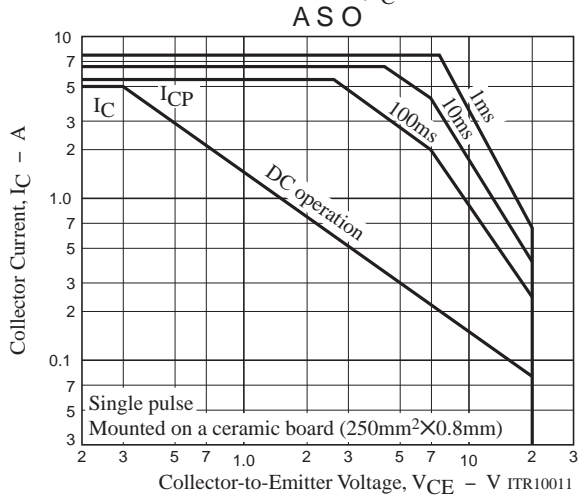
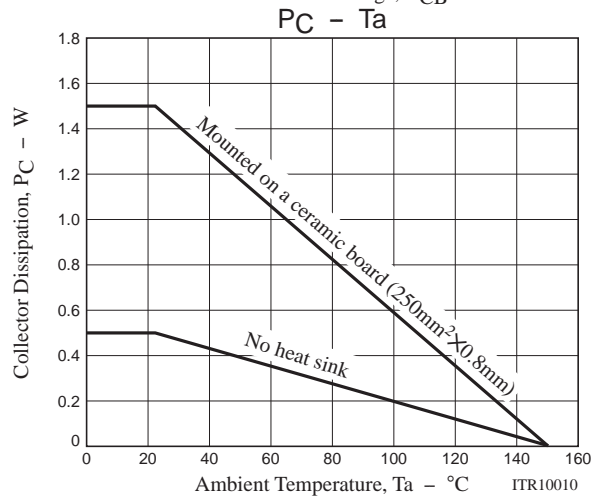
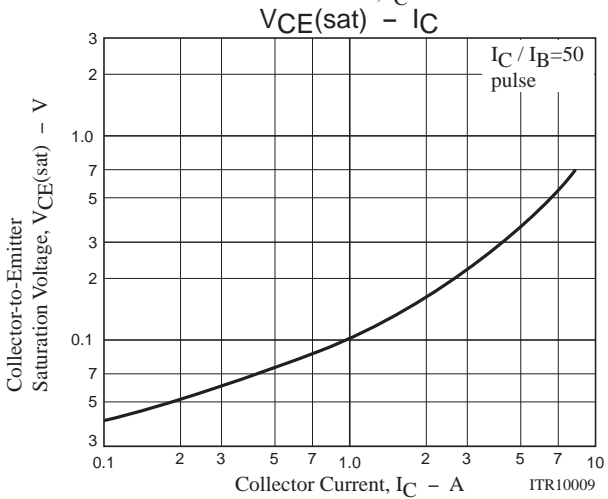
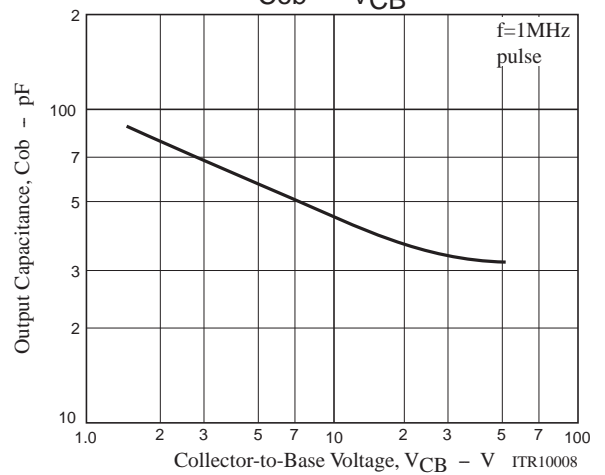
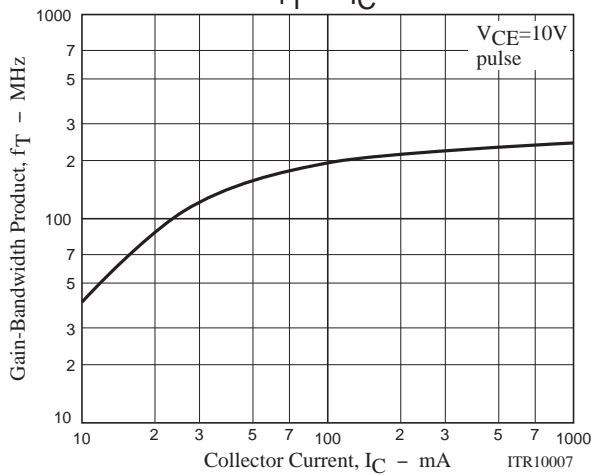
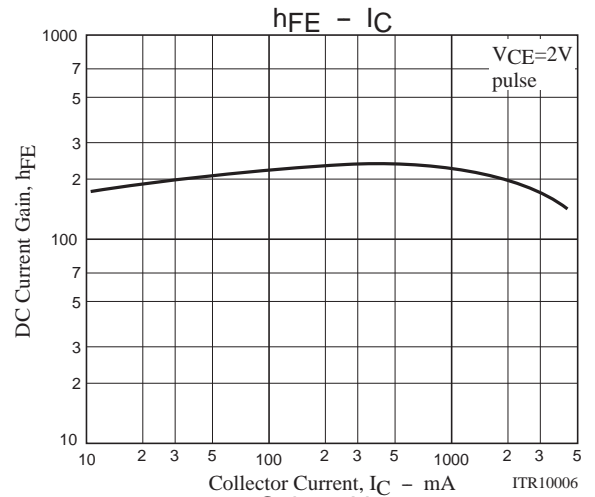
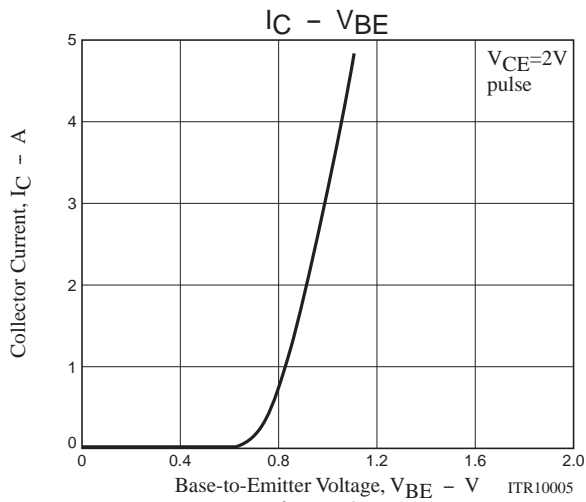

Bag Packing Specification

2SD1628G-TD-E, 2SD1628G-TD-H, 2SD1628F-TD-E, 2SD1628F-TD-H

1. Packing Format

Package Name	Carrier Tape Type	Maximum Number of devices contained (pcs)			Packing format	
		Reel	Inner box	Outer box	Inner BOX (C-1)	Outer BOX (A-7)
PCP	PCP	1,000	4,000	24,000	4 reels contained Dimensions:mm (external) 183×72×185	6 inner boxes contained Dimensions:mm (external) 440×195×210

Reel label, Inner box label
(unit : mm)

Outer box label
It is a label at the time of factory shipments.
The form of a label may change in physical distribution process.

Packing method

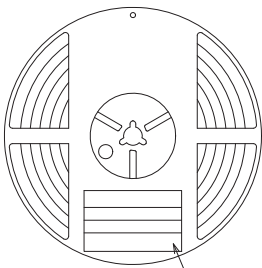

Type No.
LOT No.
Quantity
Origin

Reel label

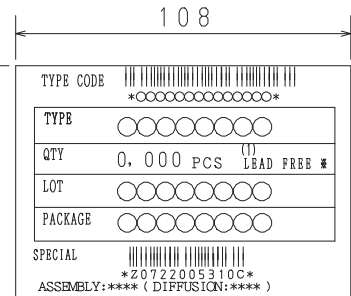
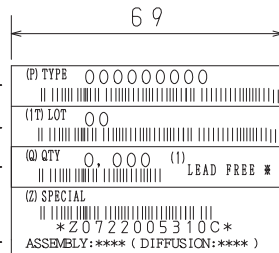

NOTE (1)

The LEAD FREE * description shows that the surface treatment of the terminal is lead free.

Label	JEITA Phase
LEAD FREE 3	JEITA Phase 3A
LEAD FREE 4	JEITA Phase 3

2. Taping configuration

2-1. Carrier tape size (unit:mm)

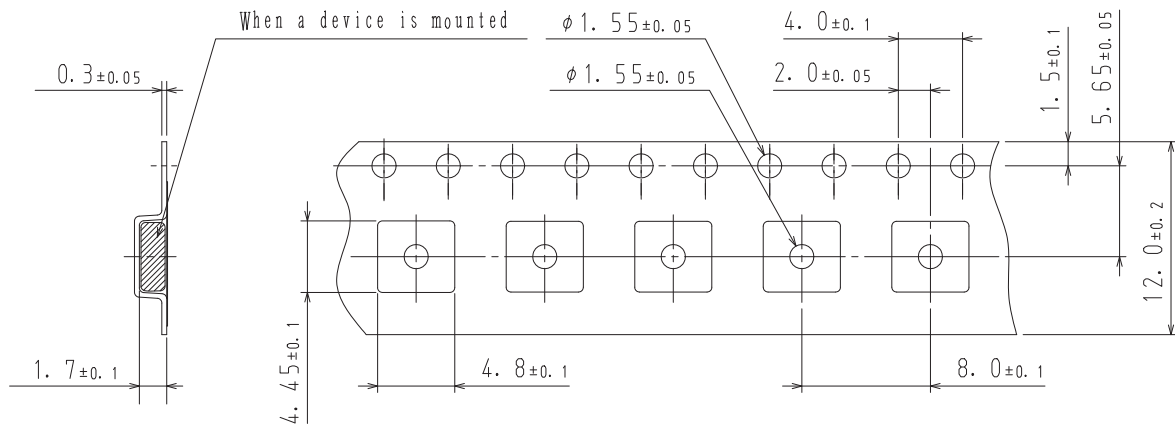

2-2. Device placement direction

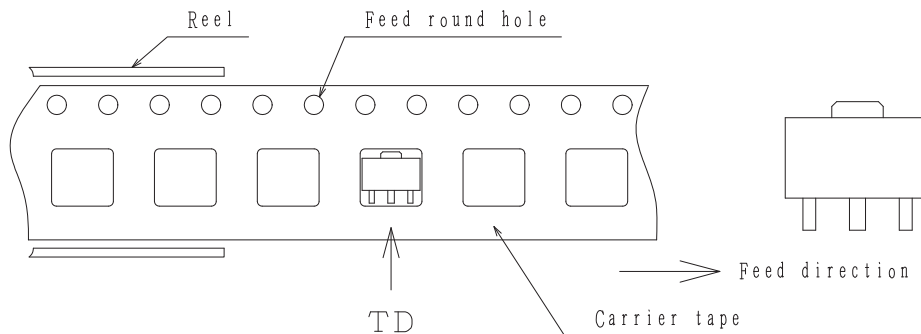

Those with pin 1 index on the feed hole side.....TD

2SD1628

Outline Drawing

2SD1628G-TD-E, 2SD1628G-TD-H, 2SD1628F-TD-E, 2SD1628F-TD-H

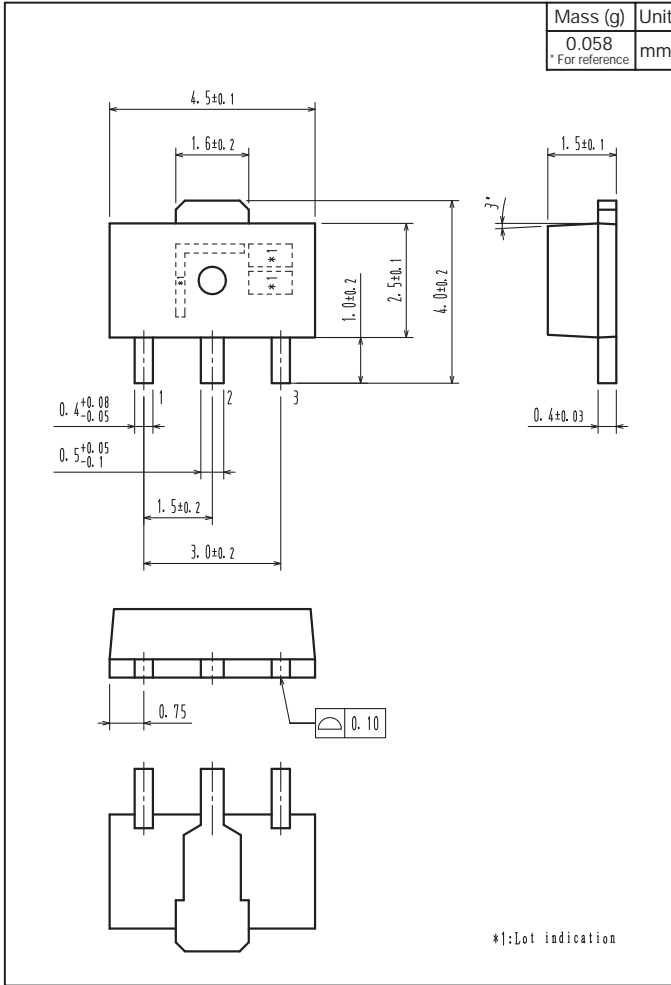

Land Pattern Example

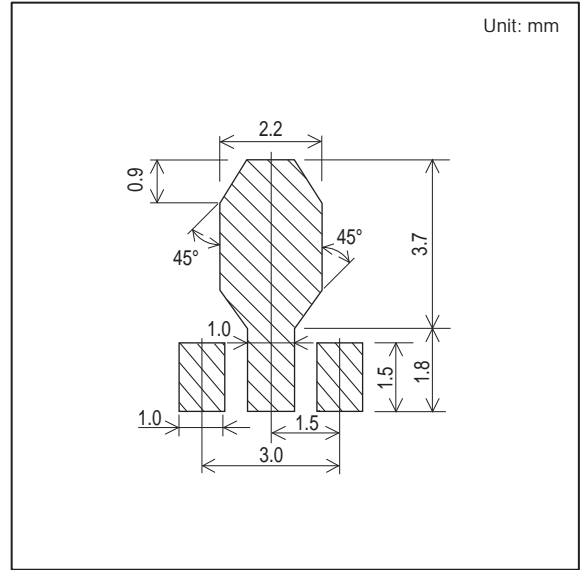

Unit: mm

ON Semiconductor and the ON logo are registered trademarks of Semiconductor Components Industries, LLC (SCILLC). SCILLC owns the rights to a number of patents, trademarks, copyrights, trade secrets, and other intellectual property. A listing of SCILLC's product/patent coverage may be accessed at www.onsemi.com/site/pdf/Patent-Marking.pdf. SCILLC reserves the right to make changes without further notice to any products herein. SCILLC makes no warranty, representation or guarantee regarding the suitability of its products for any particular purpose, nor does SCILLC assume any liability arising out of the application or use of any product or circuit, and specifically disclaims any and all liability, including without limitation special, consequential or incidental damages. "Typical" parameters which may be provided in SCILLC data sheets and/or specifications can and do vary in different applications and actual performance may vary over time. All operating parameters, including "Typicals" must be validated for each customer application by customer's technical experts. SCILLC does not convey any license under its patent rights nor the rights of others. SCILLC products are not designed, intended, or authorized for use as components in systems intended for surgical implant into the body, or other applications intended to support or sustain life, or for any other application in which the failure of the SCILLC product could create a situation where personal injury or death may occur. Should Buyer purchase or use SCILLC products for any such unintended or unauthorized application, Buyer shall indemnify and hold SCILLC and its officers, employees, subsidiaries, affiliates, and distributors harmless against all claims, costs, damages, and expenses, and reasonable attorney fees arising out of, directly or indirectly, any claim of personal injury or death associated with such unintended or unauthorized use, even if such claim alleges that SCILLC was negligent regarding the design or manufacture of the part. SCILLC is an Equal Opportunity/Affirmative Action Employer. This literature is subject to all applicable copyright laws and is not for resale in any manner.