

Power Transistor(80V,1A)

2SD1898

FEATURES

- High $V_{CEO}, V_{CEO}=80V$.
- High $I_C, I_C=1A(DC)$.
- Good H_{FE} Linearity.
- Low $V_{CE(sat)}$.
- Complement the 2SB1260.

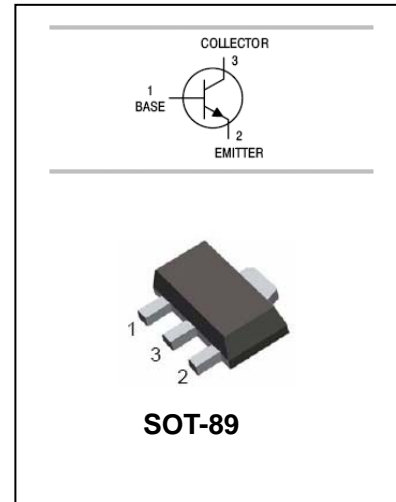

APPLICATIONS

- NPN silicon transistor.

ORDERING INFORMATION

Type No.	Marking	Package Code
2SD1898	DF	SOT-89

MAXIMUM RATING @ Ta=25°C unless otherwise specified

Symbol	Parameter	Value	Units
V_{CBO}	Collector-Base Voltage	120	V
V_{CEO}	Collector-Emitter Voltage	80	V
V_{EBO}	Emitter-Base Voltage	5	V
I_C	Collector Current -Continuous	1	A
I_C	Collector Current -pulse	2	A
P_C	Collector Dissipation	0.5	W
		1.3 Note1	W
T_j, T_{stg}	Junction and Storage Temperature	-55 to +150	°C

Note1: Mounted on ceramic substrate(250mm²*0.8t)

Power Transistor(80V,1A)

2SD1898

ELECTRICAL CHARACTERISTICS @ Ta=25°C unless otherwise specified

Parameter	Symbol	Test conditions	MIN	TYP	MAX	UNIT
Collector-base breakdown voltage	$V_{(BR)CBO}$	$I_C=50\mu A, I_E=0$	120			V
Collector-emitter breakdown voltage	$V_{(BR)CEO}$	$I_C=1mA, I_B=0$	80			V
Emitter-base breakdown voltage	$V_{(BR)EBO}$	$I_E=50\mu A, I_C=0$	5			V
Collector cut-off current	I_{CBO}	$V_{CB}=100V, I_E=0$			1	μA
Emitter cut-off current	I_{EBO}	$V_{EB}=4V, I_C=0$			1	μA
DC current gain	h_{FE}	$V_{CE}=3V, I_C=0.5A$	82		390	
Collector-emitter saturation voltage	$V_{CE(sat)}$	$I_C=500mA, I_B=20mA$		0.15	0.4	V
Transition frequency	f_T	$V_{CE}=10V, I_C=-50mA, f=100MHz$		100		MHz
Collector output capacitance	C_{ob}	$V_{CB}=10V, I_E=0, f=1MHz$		20		pF

CLASSIFICATION OF $h_{FE(1)}$

Rank	P	Q	R
Range	82-180	120-270	180-390

TYPICAL CHARACTERISTICS @ Ta=25°C unless otherwise specified

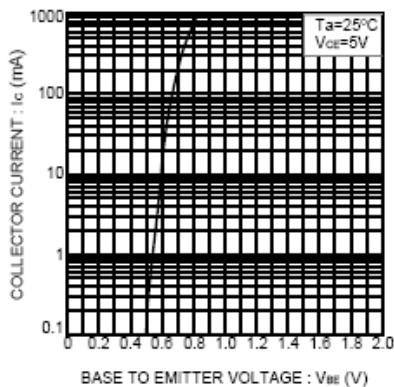

Fig.1 Grounded emitter propagation characteristics

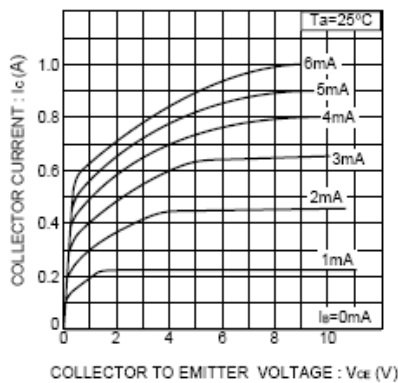

Fig.2 Grounded emitter output characteristics

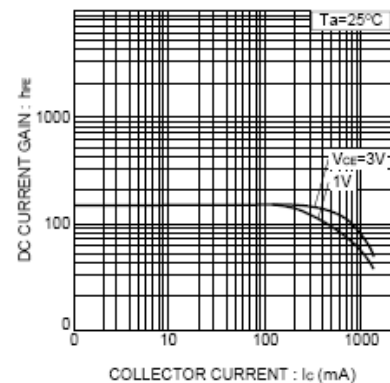

Fig.3 DC current gain vs. collector current

Power Transistor(80V,1A)

2SD1898

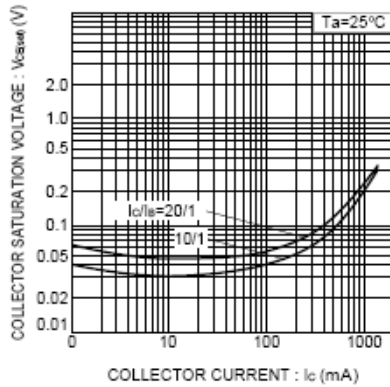

Fig.4 Collector-emitter saturation voltage vs. collector current

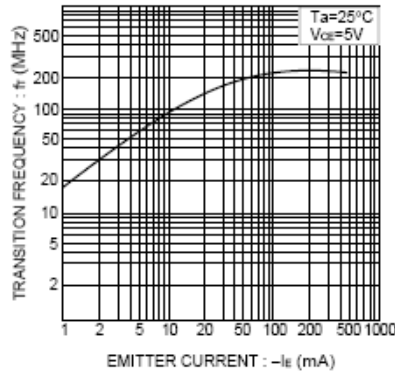

Fig.5 Gain bandwidth product vs. emitter current

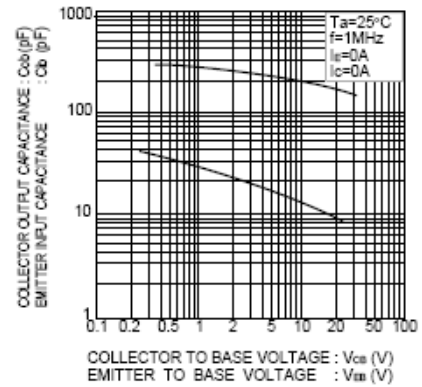

Fig.6 Collector output capacitance vs. collector-base voltage
Emitter input capacitance vs. emitter-base voltage

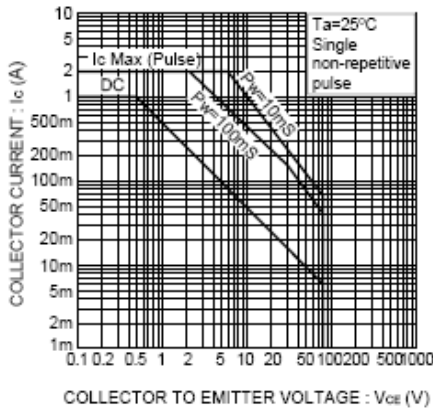

Fig.8 Safe operating area

Power Transistor(80V,1A)

2SD1898

PACKAGE OUTLINE

Plastic surface mounted package

SOT-89

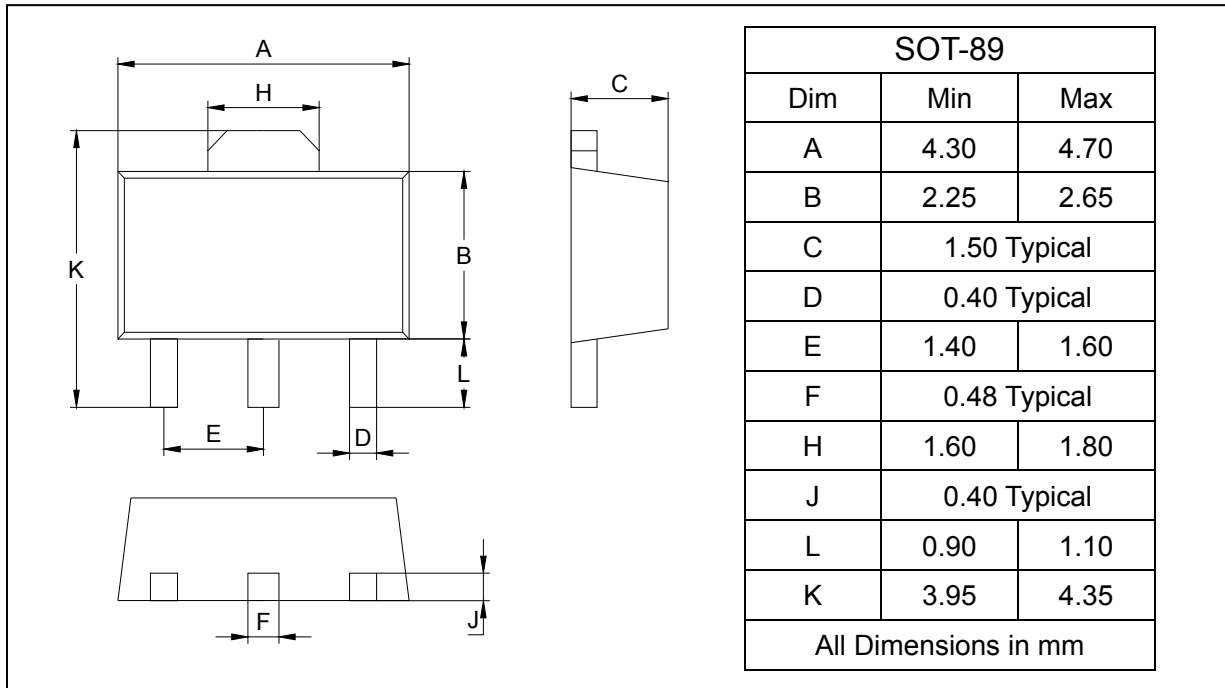

SOLDERING FOOTPRINT

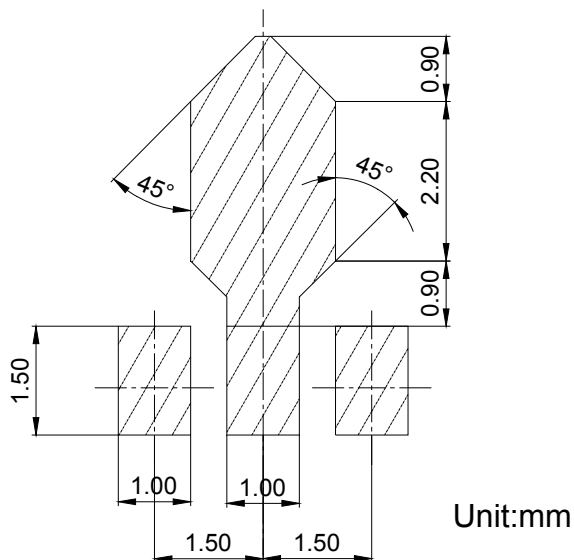

PACKAGE INFORMATION

Device	Package	Shipping
2SD1898	SOT-89	1000/Tape&Reel