

Silicon NPN Power Transistors

2SD895

DESCRIPTION

www.datasheet4u.com

- With TO-3PN package
- Complement to type 2SB775
- Wide area of safe operation

APPLICATIONS

- 85V/6A, AF 35W output applications

PINNING

PIN	DESCRIPTION
1	Base
2	Collector;connected to mounting base
3	Emitter

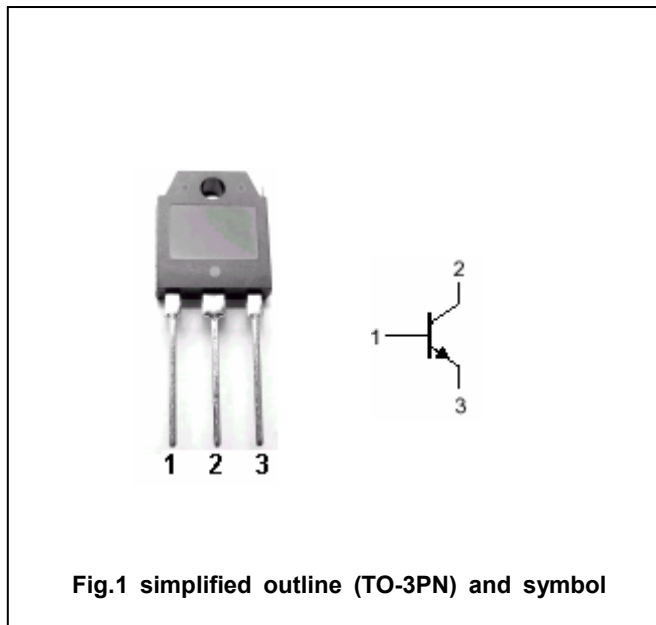

Fig.1 simplified outline (TO-3PN) and symbol

Absolute maximum ratings(Tc=25°C)

SYMBOL	PARAMETER	CONDITIONS	VALUE	UNIT
V _{CBO}	Collector-base voltage	Open emitter	100	V
V _{CEO}	Collector-emitter voltage	Open base	85	V
V _{EBO}	Emitter-base voltage	Open collector	6	V
I _C	Collector current (DC)		6	A
I _{CM}	Collector current-peak		10	A
P _C	Collector power dissipation	T _C =25°C	60	W
T _j	Junction temperature		150	°C
T _{stg}	Storage temperature		-40~150	°C

Silicon NPN Power Transistors

2SD895

CHARACTERISTICS

T_j=25°C unless otherwise specified

www.datasheet4u.com

SYMBOL	PARAMETER	CONDITIONS	MIN	TYP.	MAX	UNIT
V _{(BR)CEO}	Collector-emitter breakdown voltage	I _C =50mA ; R _{BE} =∞	85			V
V _{(BR)CBO}	Collector-base breakdown voltage	I _C =5mA ; I _E =0	100			V
V _{(BR)EBO}	Emitter-base breakdown voltage	I _E =5mA ; I _C =0	6			V
V _{CEsat}	Collector-emitter saturation voltage	I _C =4A ; I _B =0.4A		0.9	2.0	V
V _{BE}	Base-emitter on voltage	I _C =1A ; V _{CE} =5V			1.5	V
I _{CBO}	Collector cut-off current	V _{CB} =40V I _E =0			0.1	mA
I _{EBO}	Emitter cut-off current	V _{EB} =4V ; I _C =0			0.1	mA
h _{FE-1}	DC current gain	I _C =1A ; V _{CE} =5V	60		200	
h _{FE-2}	DC current gain	I _C =3A ; V _{CE} =5V	20			
f _T	Transition frequency	I _C =1A ; V _{CE} =5V		15		MHz
C _{OB}	Collector output capacitance	f=1MHz ; V _{CB} =10V		160		pF

Switching times

t _{on}	Turn-on time	I _C =1.0A ; I _{B1} =-I _{B2} =0.1A R _L =20Ω		0.20		μs
t _{stg}	Storage time			0.82		μs
t _f	Fall time			3.88		μs

◆ h_{FE-1} Classifications

D	E
60-120	100-200

PACKAGE OUTLINE

www.datasheet4u.com

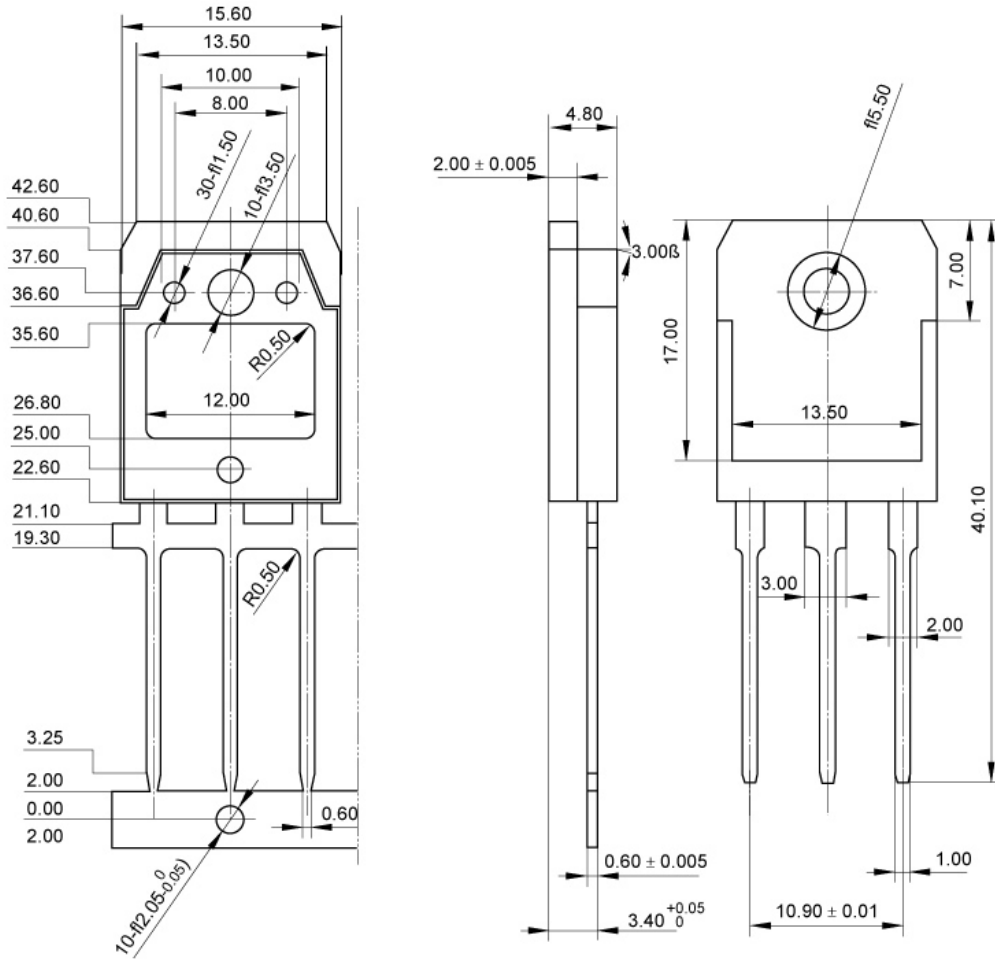

Fig.2 outline dimensions

Silicon NPN Power Transistors

2SD895

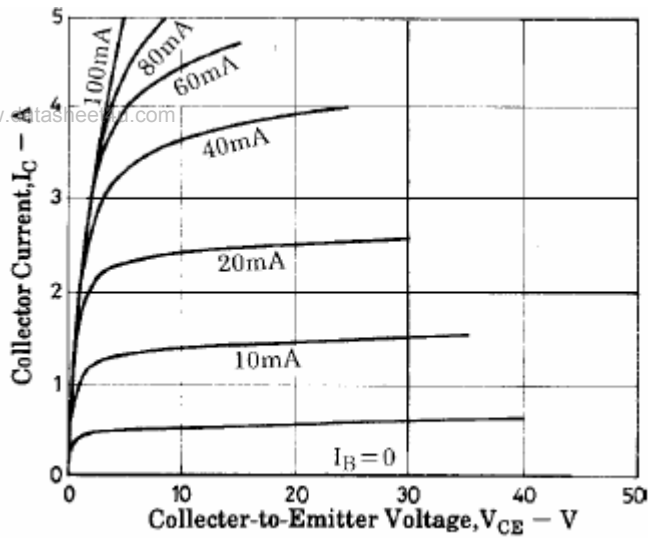

Fig.3 Static Characteristic

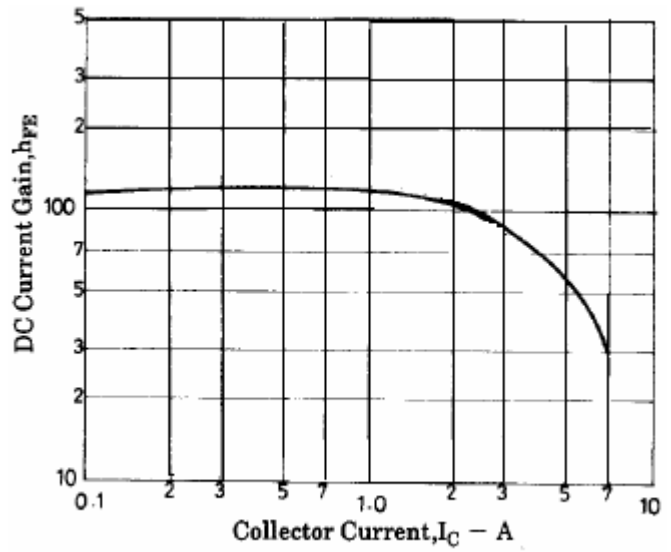

Fig.4 DC current Gain

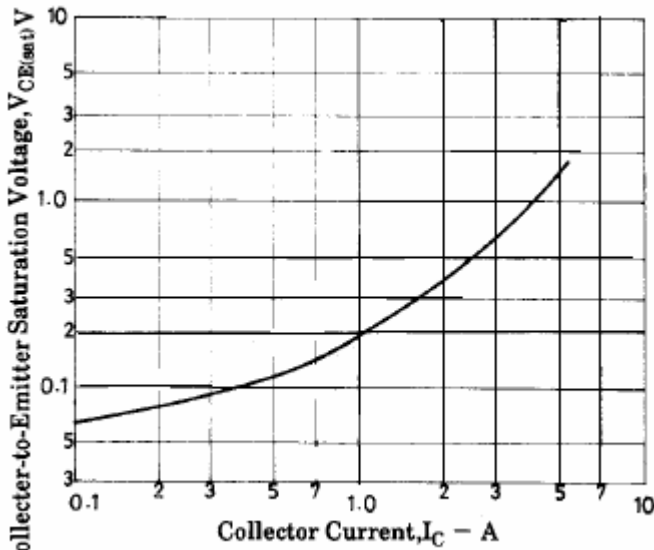

Fig.5 Collector-Emmitter Saturation Voltage

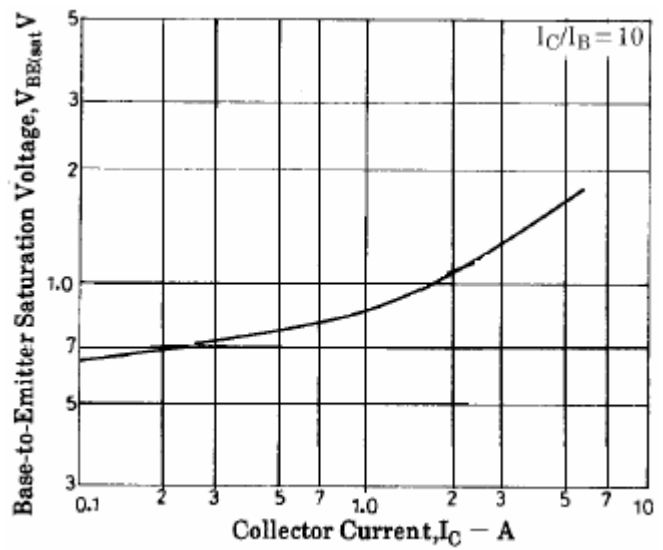

Fig.6 Base-Emmitter Saturation Voltage

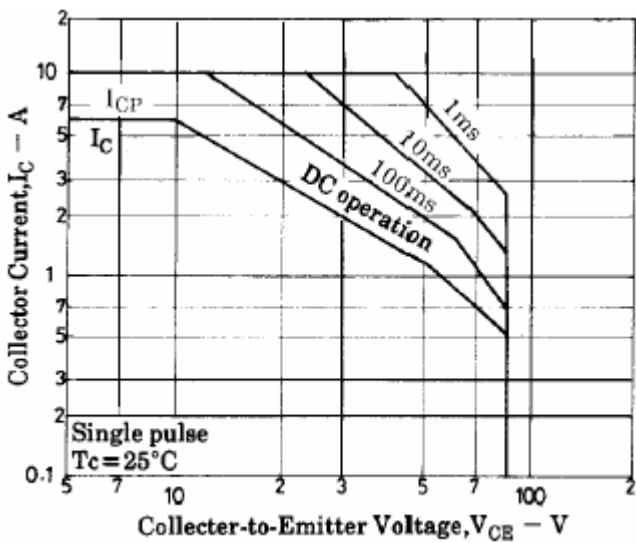

Fig.7 Safe Operating Area