

Silicon NPN Power Transistors

2SD896

DESCRIPTION

www.datasheet4u.com

- With TO-3PN package
- Complement to type 2SB776
- Wide area of safe operation

APPLICATIONS

- 100V/7A, AF 40W output applications

PINNING

| PIN | DESCRIPTION                          |
|-----|--------------------------------------|
| 1   | Base                                 |
| 2   | Collector;connected to mounting base |
| 3   | Emitter                              |

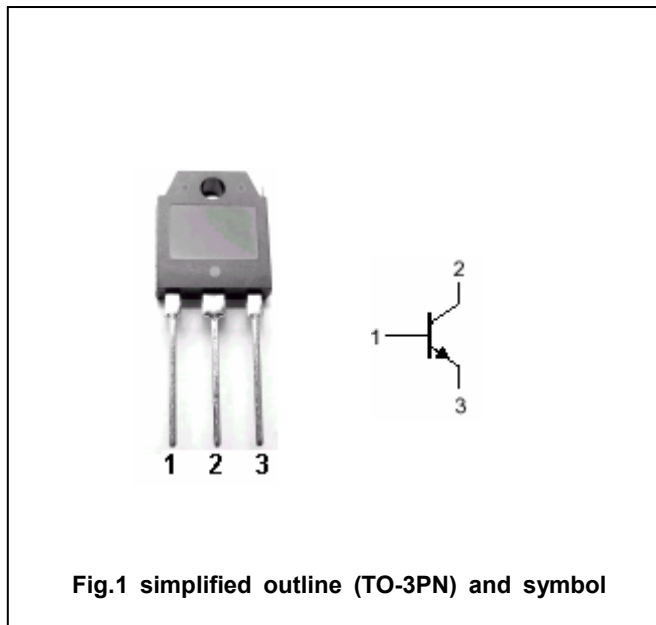

Fig.1 simplified outline (TO-3PN) and symbol

Absolute maximum ratings(Tc=25°C)

| SYMBOL           | PARAMETER                   | CONDITIONS           | VALUE   | UNIT |
|------------------|-----------------------------|----------------------|---------|------|
| V <sub>CBO</sub> | Collector-base voltage      | Open emitter         | 120     | V    |
| V <sub>CEO</sub> | Collector-emitter voltage   | Open base            | 100     | V    |
| V <sub>EBO</sub> | Emitter-base voltage        | Open collector       | 6       | V    |
| I <sub>C</sub>   | Collector current (DC)      |                      | 7       | A    |
| I <sub>CM</sub>  | Collector current-peak      |                      | 11      | A    |
| P <sub>C</sub>   | Collector power dissipation | T <sub>C</sub> =25°C | 70      | W    |
| T <sub>j</sub>   | Junction temperature        |                      | 150     | °C   |
| T <sub>stg</sub> | Storage temperature         |                      | -40~150 | °C   |

## Silicon NPN Power Transistors

## 2SD896

## CHARACTERISTICS

T<sub>j</sub>=25°C unless otherwise specified

www.datasheet4u.com

| SYMBOL               | PARAMETER                            | CONDITIONS                                | MIN | TYP. | MAX | UNIT |
|----------------------|--------------------------------------|---|-----|------|-----|------|
| V <sub>(BR)CEO</sub> | Collector-emitter breakdown voltage  | I <sub>C</sub> =50mA ; R <sub>BE</sub> =∞ | 100 |      |     | V    |
| V <sub>(BR)CBO</sub> | Collector-base breakdown voltage     | I <sub>C</sub> =5mA ; I <sub>E</sub> =0   | 120 |      |     | V    |
| V <sub>(BR)EBO</sub> | Emitter-base breakdown voltage       | I <sub>E</sub> =5mA ; I <sub>C</sub> =0   | 6   |      |     | V    |
| V <sub>CEsat</sub>   | Collector-emitter saturation voltage | I <sub>C</sub> =4A ; I <sub>B</sub> =0.4A |     | 0.6  | 2.0 | V    |
| V <sub>BE</sub>      | Base-emitter on voltage              | I <sub>C</sub> =1A ; V <sub>CE</sub> =5V  |     |      | 1.5 | V    |
| I <sub>CBO</sub>     | Collector cut-off current            | V <sub>CB</sub> =80V I <sub>E</sub> =0    |     |      | 0.1 | mA   |
| I <sub>EBO</sub>     | Emitter cut-off current              | V <sub>EB</sub> =4V ; I <sub>C</sub> =0   |     |      | 0.1 | mA   |
| h <sub>FE-1</sub>    | DC current gain                      | I <sub>C</sub> =1A ; V <sub>CE</sub> =5V  | 60  |      | 200 |      |
| h <sub>FE-2</sub>    | DC current gain                      | I <sub>C</sub> =4A ; V <sub>CE</sub> =5V  | 20  |      |     |      |
| f <sub>T</sub>       | Transition frequency                 | I <sub>C</sub> =1A ; V <sub>CE</sub> =5V  |     | 15   |     | MHz  |
| C <sub>OB</sub>      | Collector output capacitance         | f=1MHz ; V <sub>CB</sub> =10V             |     | 140  |     | pF   |

## Switching times

|                  |              |  |  |     |  |    |
|------------------|--------------|--|--|-----|--|----|
| t <sub>on</sub>  | Turn-on time | I <sub>C</sub> =1.0A ; I <sub>B1</sub> =-I <sub>B2</sub> =0.1A<br>R <sub>L</sub> =20Ω ; V <sub>CC</sub> =20V |  | 0.2 |  | μs |
| t <sub>stg</sub> | Storage time |  |  | 6.0 |  | μs |
| t <sub>f</sub>   | Fall time    |  |  | 0.6 |  | μs |

◆ h<sub>FE-1</sub> Classifications

| D      | E       |
|--------|---------|
| 60-120 | 100-200 |

Silicon NPN Power Transistors

2SD896

PACKAGE OUTLINE

www.datasheet4u.com

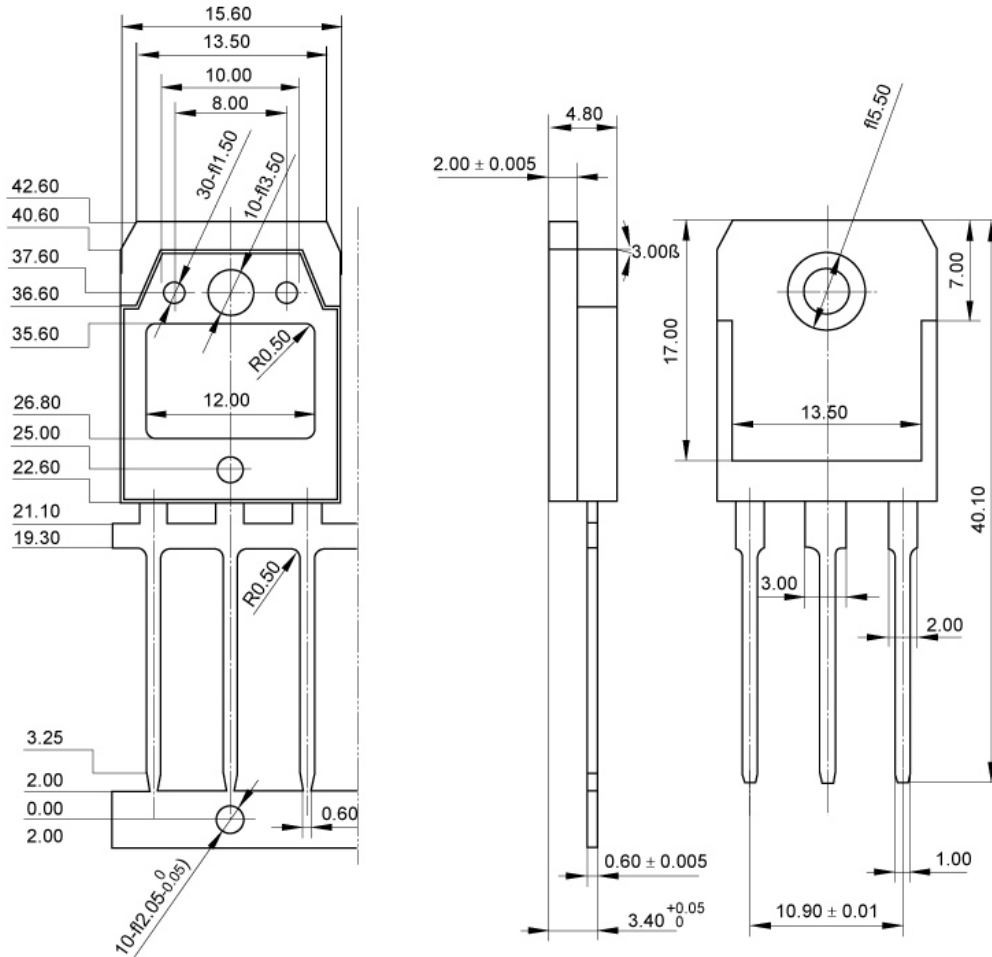

Fig.2 outline dimensions

Silicon NPN Power Transistors

2SD896

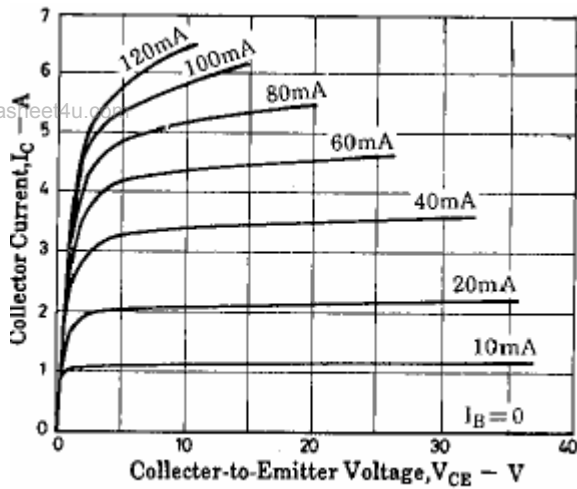

Fig.3 Static Characteristic

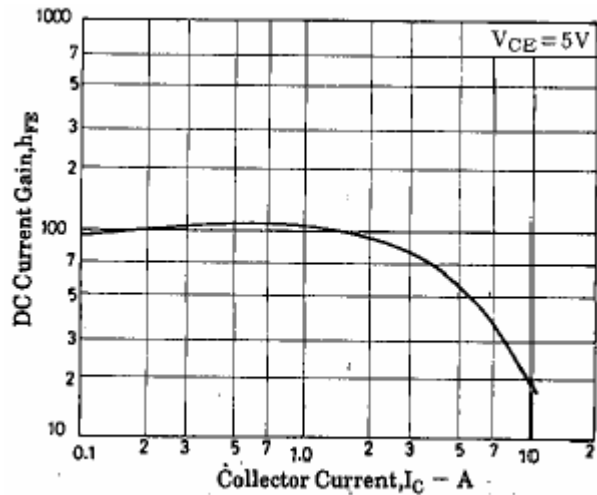

Fig.4 DC current Gain

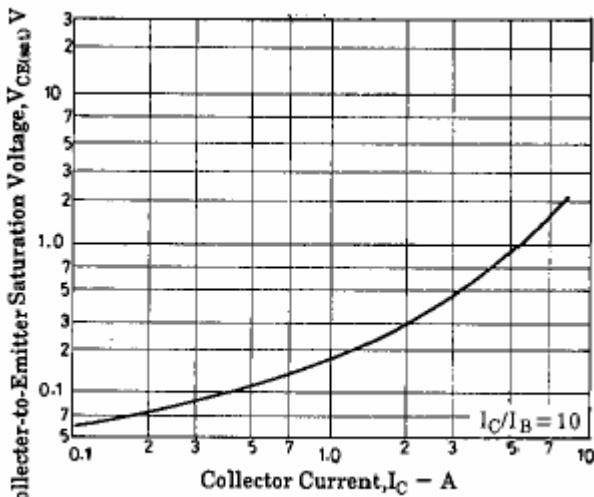

Fig.5 Collector-Emmitter Saturation Voltage

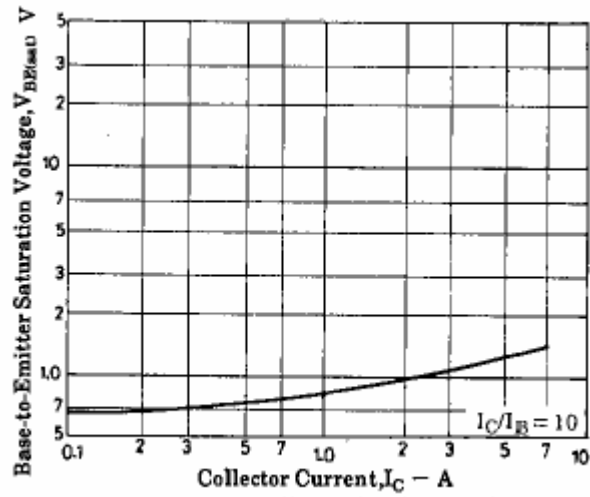

Fig.6 Base-Emmitter Saturation Voltage

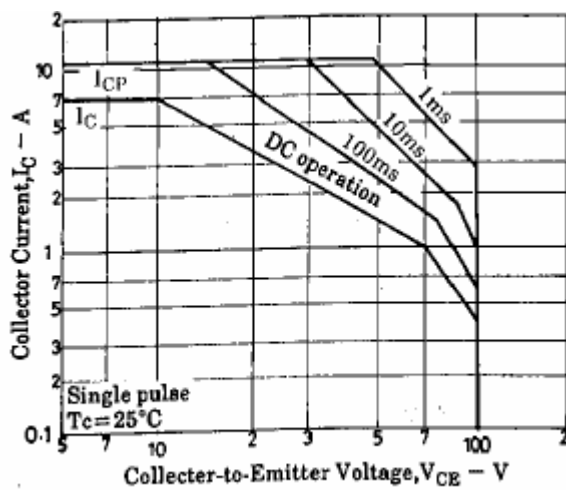

Fig.7 Safe Operating Area