

# MOS FIELD EFFECT TRANSISTOR 2SJ198

## P-CHANNEL MOS FET FOR SWITCHING

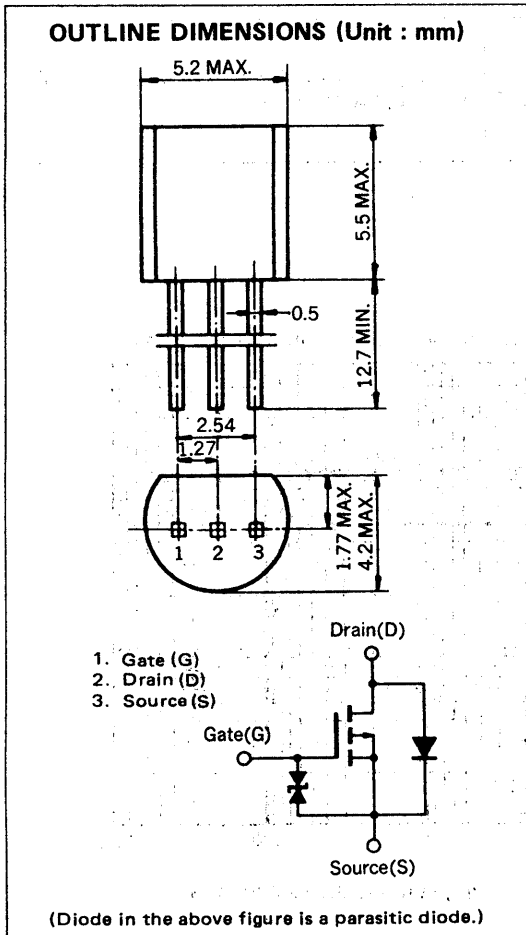

The 2SJ198 is a p-channel vertical type MOS FET switching device which can be directly driven from an IC operating with a 5 V single power supply. The device featuring low ON-state resistance is of the voltage drive type and thus is ideal for driving actuators such as motors, solenoids, and relays.

### FEATURES

- Low ON-state resistance  
 $R_{DS(on)} = 2.5 \Omega \text{ MAX. at } V_{GS} = -4 \text{ V, } I_D = -0.5 \text{ A}$   
 $R_{DS(on)} = 2.0 \Omega \text{ MAX. at } V_{GS} = -10 \text{ V, } I_D = -0.5 \text{ A}$
- Voltage drive at logic level ( $V_{GS} = -4 \text{ V}$ ) is possible.
- Bidirectional zener diode for protection is incorporated in between the Gate and the Source.
- Inductive loads can be driven without protective circuit thanks to the improved breakdown voltage between the Drain and Source.
- Complementary to 2SK1484

### ABSOLUTE MAXIMUM RATINGS ( $T_A = 25^\circ\text{C}$ )

CHARACTERISTIC	SYMBOL	RATINGS	UNIT	TEST CONDITIONS
Drain to Source Voltage	$V_{DS}$	-100	V	$V_{GS} = 0$
Gate to Source Voltage	$V_{GS}$	$\pm 20$	V	$V_{DS} = 0$
Drain Current (DC)	$I_D(\text{DC})$	$\pm 0.5$	A	
Drain Current (pulse)	$I_D(\text{pulse})$	$\pm 1.0$	A	$PW \leq 10 \text{ ms, Duty Cycle} \leq 50 \%$
Total Power Dissipation	$P_T$	750	mW	
Channel Temperature	$T_{ch}$	150	$^\circ\text{C}$	
Storage Temperature	$T_{stg}$	-55 to +150	$^\circ\text{C}$	

ELECTRICAL CHARACTERISTICS (T<sub>A</sub> = 25 °C)

CHARACTERISTIC	SYMBOL	MIN.	TYP.	MAX.	UNIT	CONDITIONS
Drain Cut-off Current	I <sub>DSS</sub>			-10	μA	V <sub>DS</sub> = -100 V, V <sub>GS</sub> = 0
Gate Leakage Current	I <sub>GSS</sub>			±10	μA	V <sub>GS</sub> = ±20 V, V <sub>DS</sub> = 0
Gate Cut-off Voltage	V <sub>GS(off)</sub>	-1.0	-2.1	-3.0	V	V <sub>DS</sub> = -10 V, I <sub>D</sub> = -1 mA
Forward Transfer Admittance	y <sub>fs</sub>	0.4	0.9		S	V <sub>DS</sub> = -10 V, I <sub>D</sub> = -0.5 A
Drain to Source On-State Resistance	R <sub>DS(on)1</sub>		1.5	2.5	Ω	V <sub>GS</sub> = -4.0 V, I <sub>D</sub> = -0.5 A
Drain to Source On-State Resistance	R <sub>DS(on)2</sub>		1.1	2.0	Ω	V <sub>GS</sub> = -10 V, I <sub>D</sub> = -0.5 A
Input Capacitance	C <sub>iss</sub>		220		pF	V <sub>DS</sub> = -10 V, V <sub>GS</sub> = 0, f = 1 MHz
Output Capacitance	C <sub>oss</sub>		85		pF	
Feedback Capacitance	C <sub>rss</sub>		8		pF	
Turn-On Delay Time	t <sub>d(on)</sub>		45		ns	V <sub>GS(on)</sub> = -10 V, R <sub>G</sub> = 10 Ω, V <sub>DD</sub> = -25 V, I <sub>D</sub> = -0.5 A, R <sub>L</sub> = 50 Ω
Rise Time	t <sub>r</sub>		36		ns	
Turn-Off Delay Time	t <sub>d(off)</sub>		360		ns	
Fall Time	t <sub>f</sub>		90		ns	

TYPICAL CHARACTERISTICS (T<sub>A</sub> = 25 °C)

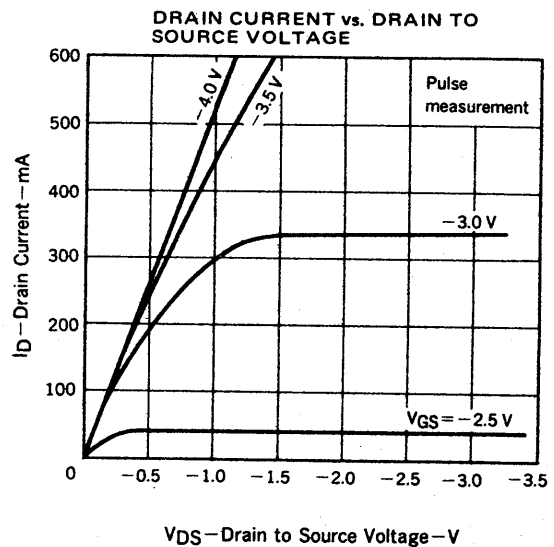
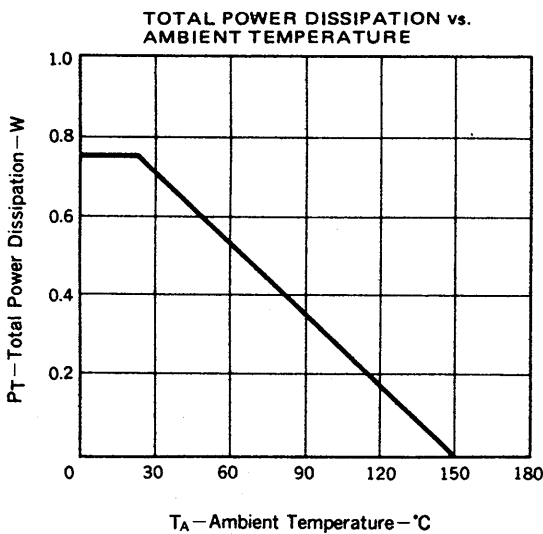
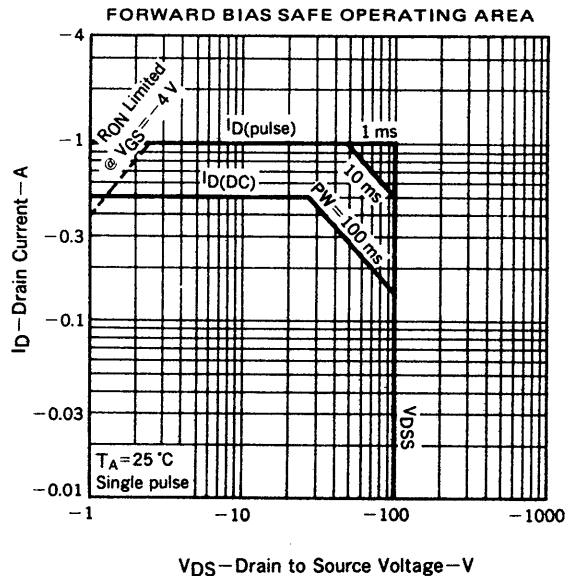
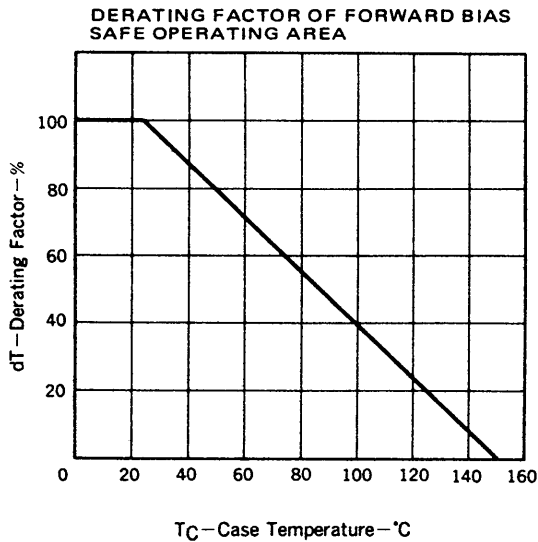

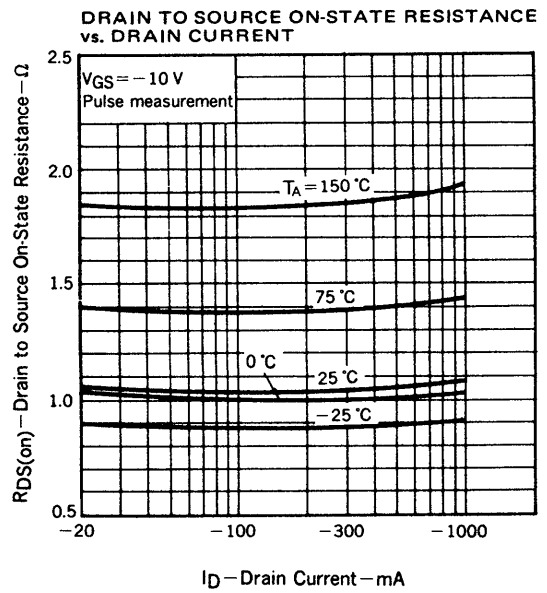
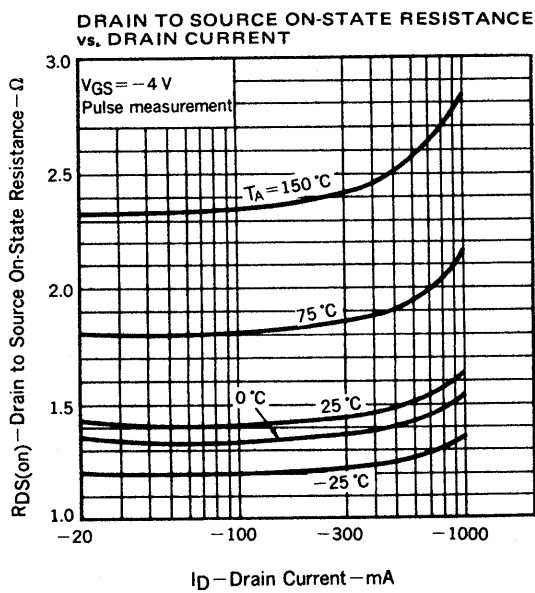
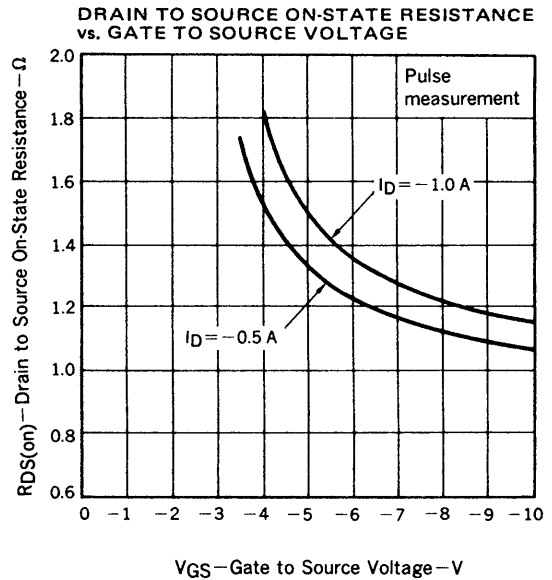
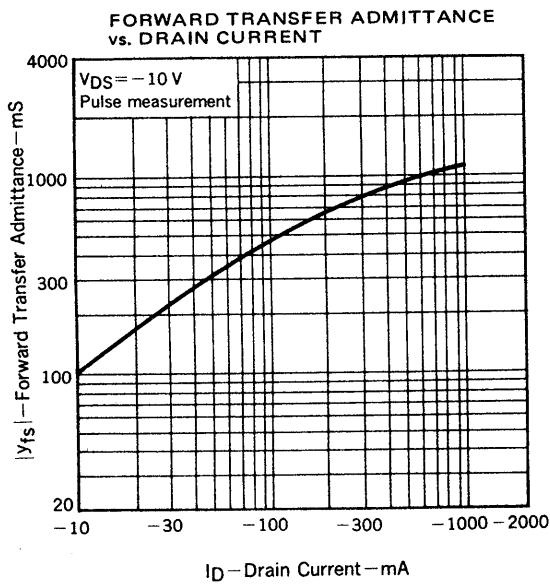
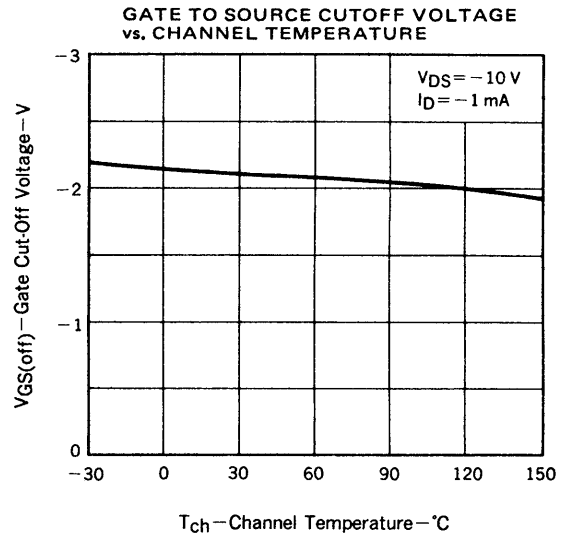
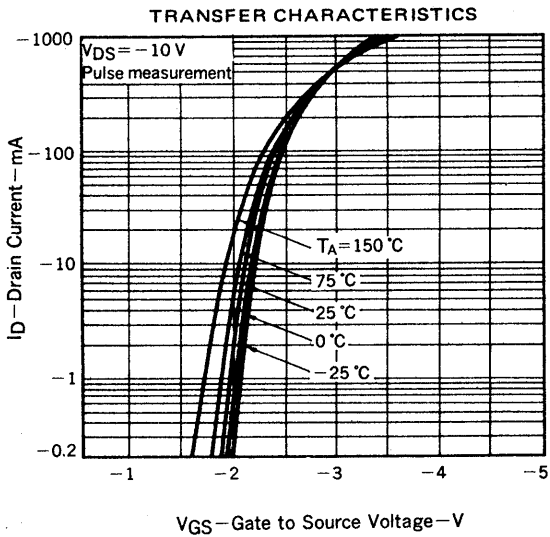

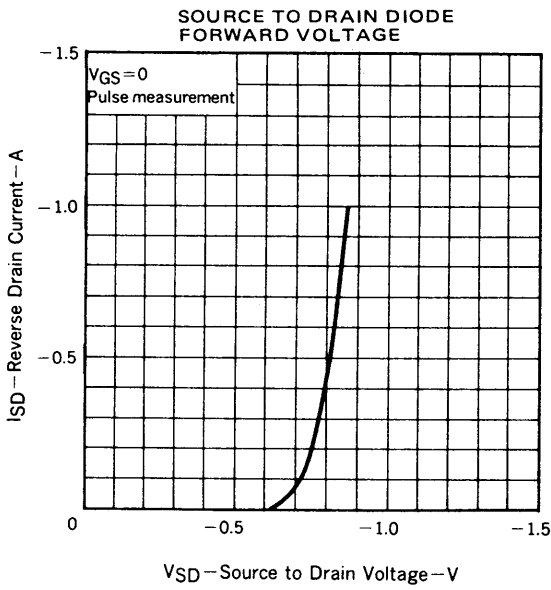
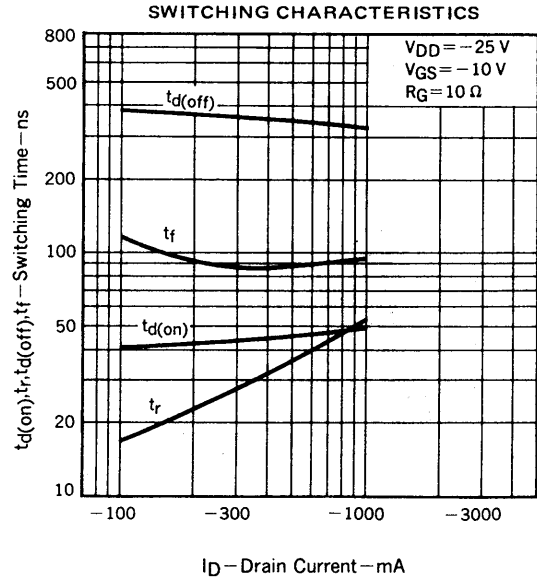
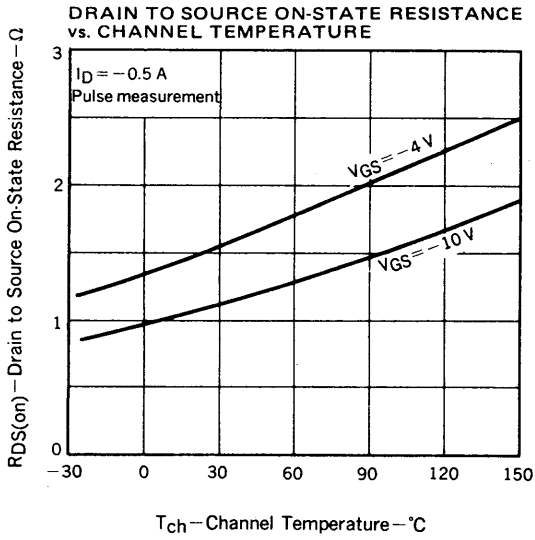

**SWITCHING TIME MEASUREMENT CIRCUIT AND CONDITIONS**

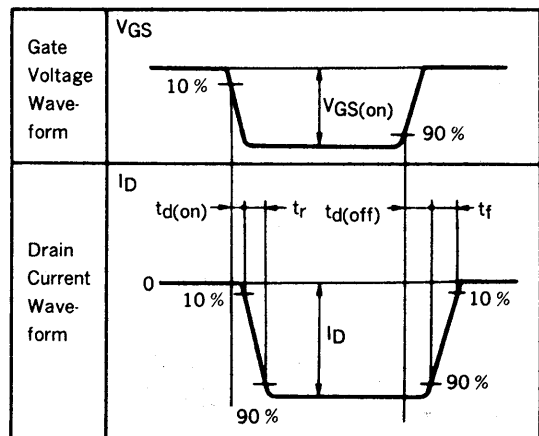
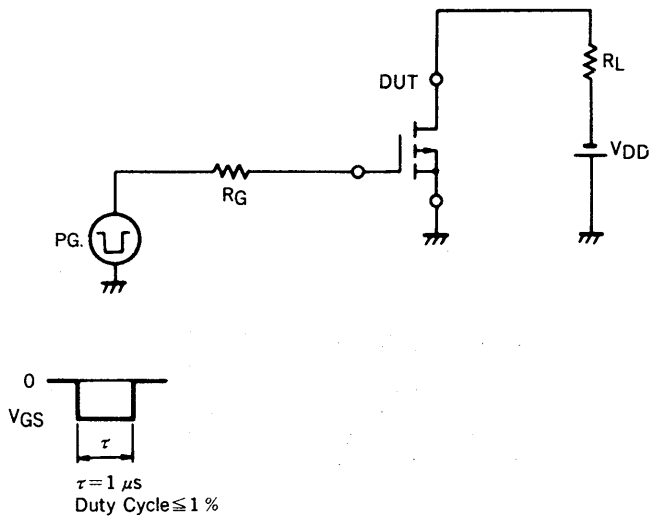

**RECOMMENDED SOLDERING CONDITIONS**

Solder this product under the following recommended conditions.

For soldering methods or soldering conditions other than those recommended in the table, please consult our NEC salespeople.

**Insert type**

Soldering method	Soldering conditions	Recommended condition code
Wave soldering	Solder bath temperature: 260 °C max. Soldering time: 10 sec max.	

[MEMO]

No part of this document may be copied or reproduced in any form or by any means without the prior written consent of NEC Corporation. NEC Corporation assumes no responsibility for any errors which may appear in this document.

NEC Corporation does not assume any liability for infringement of patents, copyrights or other intellectual property rights of third parties by or arising from use of a device described herein or any other liability arising from use of such device. No license, either express, implied or otherwise, is granted under any patents, copyrights or other intellectual property rights of NEC Corporation or others.

While NEC Corporation has been making continuous effort to enhance the reliability of its semiconductor devices, the possibility of defects cannot be eliminated entirely. To minimize risks of damage or injury to persons or property arising from a defect in an NEC semiconductor device, customers must incorporate sufficient safety measures in its design, such as redundancy, fire-containment, and anti-failure features.

NEC devices are classified into the following three quality grades:

"Standard", "Special", and "Specific". The Specific quality grade applies only to devices developed based on a customer designated "quality assurance program" for a specific application. The recommended applications of a device depend on its quality grade, as indicated below. Customers must check the quality grade of each device before using it in a particular application.

**Standard:** Computers, office equipment, communications equipment, test and measurement equipment, audio and visual equipment, home electronic appliances, machine tools, personal electronic equipment and industrial robots

**Special:** Transportation equipment (automobiles, trains, ships, etc.), traffic control systems, anti-disaster systems, anti-crime systems, safety equipment and medical equipment (not specifically designed for life support)

**Specific:** Aircrafts, aerospace equipment, submersible repeaters, nuclear reactor control systems, life support systems or medical equipment for life support, etc.

The quality grade of NEC devices is "Standard" unless otherwise specified in NEC's Data Sheets or Data Books. If customers intend to use NEC devices for applications other than those specified for Standard quality grade, they should contact an NEC sales representative in advance.

Anti-radioactive design is not implemented in this product.