

Fuji power MOSFET Specification

2SK1018

1. Scope
This specifies Fuji power MOSFET 2SK1018

2. Outline
 I) Construction N-channel enhancement mode power MOSFET
 II) Application for switching
 III) Outview T0-3P (MK5C24562)

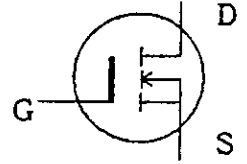

3. Absolute maximum ratings at $T_c=25^\circ\text{C}$ (unless otherwise specified)

Description	Symbol	Characteristics	Unit	Remarks
Drain-source voltage	V_{DS}	500	V	
Drain-gate voltage	V_{DGR}	500	V	$R_{GS}=20\text{K}\Omega$
Continuous Drain current	I_D	18	A	
Pulsed drain current	I_{Dpulse}	44	A	
Gate-source voltage	V_{GS}	± 30	V	
Maximum power dissipation	P_D	125	W	
Operating and storage temperature range	T_{ch}	150	$^\circ\text{C}$	
	T_{stg}	-55 ~ +150	$^\circ\text{C}$	

4. Electrical characteristics at $T_c=25^\circ\text{C}$ (unless otherwise specified)
Static ratings

Description	Symbol	Conditions	Characteristics			Unit	
			Min.	Typ.	Max.		
Drain-source breakdown voltage	$B V_{DSS}$	$I_D = 1\text{mA}$ $V_{GS} = 0\text{V}$	500			V	
Gate threshold voltage	$V_{GS(th)}$	$I_D = 1\text{mA}$ $V_{DS} = V_{GS}$	2.5	3.5	5.0	V	
Zero gate voltage drain current	I_{DSS}	$V_{DS} = 500\text{V}$ $V_{GS} = 0\text{V}$	$T_{ch} = 25^\circ\text{C}$		10	500	μA
	I_{DSS}		$T_{ch} = 125^\circ\text{C}$		0.2	1.0	mA
Gate-source leakage current	I_{GSS}	$V_{GS} = \pm 30\text{V}$ $V_{DS} = 0\text{V}$		10	100	nA	
Drain-source on-state resistance	$R_{DS(on)}$	$I_D = 8\text{A}$ $V_{GS} = 10\text{V}$		0.30	0.45	Ω	

This material and the information herein is the property of Fuji Electric Co., Ltd. They shall be neither reproduced, copied, lent, or disclosed in any way whatsoever for the use of any third party nor used for the manufacturing purposes without the express written consent of Fuji Electric Co., Ltd.

DATE	NAME	APPROVED	Fuji Electric Co., Ltd.	DWG. NO. MT5F1764	1/15
DRAWN	Aug. -20-'90 T. SHIOYAMA				
CHECKED	Aug. -21-'90 T. Arai				
REVISIONS	Aug. -21-'90 S. Furukata				

Dynamic ratings

Description	Symbol	Conditions	Characteristics			Unit
			Min.	Typ.	Max.	
Forward transconductance	g_{fs}	$I_D = 8A$ $V_{DS} = 25V$	5.0	10		S
Input capacitance	C_{iss}	$V_{DS} = 25V$ $V_{GS} = 0V$ $f = 1MHz$		1800	2700	pF
Output capacitance	C_{oss}			270	410	pF
Reverse transfer capacitance	C_{rss}			120	180	pF
Turn-on time	$t_{d(on)}$	$V_{CC} = 300V$ $V_{GS} = 10V$ $I_D = 18A$ $R_{GS} = 25\Omega$		70	110	ns
	t_r			100	150	ns
Turn-off time	$t_{d(off)}$			250	380	ns
	t_f			80	120	ns

Reverse diode

Description	Symbol	Conditions	Characteristics			Unit
			Min.	Typ.	Max.	
Continuous reverse drain current	I_{DR}	$T_C = 25^\circ C$			18	A
Pulsed reverse drain current	I_{DRM}	$T_C = 25^\circ C$			44	A
Diode forward on-voltage	V_{SD}	$I_F = 2 \times I_{DR}$ $V_{GS} = 0V, T_{ch} = 25^\circ C$		1.18	1.70	V
Reverse recovery time	t_{rr}	$I_F = I_{DR}$ $dI_F/dt = 100A/\mu S$ $T_{ch} = 25^\circ C$		500		ns
Reverse recovery charge	Q_{rr}			4.5		μC

5. Thermal resistance

Description	Symbol	Conditions	Characteristics			Unit
			Min.	Typ.	Max.	
Thermal resistance	$R_{th_{ch-c}}$				1.0	$^\circ C/W$
	$R_{th_{ch-a}}$				35.0	$^\circ C/W$

DATE	NAME	APPROVED	Fuji Electric Co.,Ltd.		
DRAWN	-		DWG.NO.	MT5F1764	3/15
CHECKED	-				
REVISIONS					

This material and the information herein is the property of Fuji Electric Co., Ltd. They shall be neither reproduced, copied, lent, or disclosed in any way whatsoever for the use of any third party nor used for the manufacturing purposes without the express written consent of Fuji Electric Co., Ltd.

This material and the information herein is the property of Fuji Electric Co., Ltd. They shall be neither reproduced, copied, lent, or disclosed in any way whatsoever for the use of any third party, nor used for the manufacturing purposes without the express written consent of Fuji Electric Co., Ltd.

6. 御注意 (Attention)

本製品は外国為替および外国貿易管理法の規定により戦略物資（または役務）に該当しますので、輸出する場合には、同法に基づき通商産業大臣の輸出許可が必要です。

This product described in this specification contain strategic product subject to COCOM requirements. They should not be exported without authorization from the appropriate governmental authorities.

REVISEMENTS		DATE	NAME	APPROVED	Fuji Electric Co., Ltd.		
	DRAWN	- -			DWG. NO.	MTS F1764	3/15
	CHECKED	- -					

Power dissipation

$$P_D = f(T_C)$$

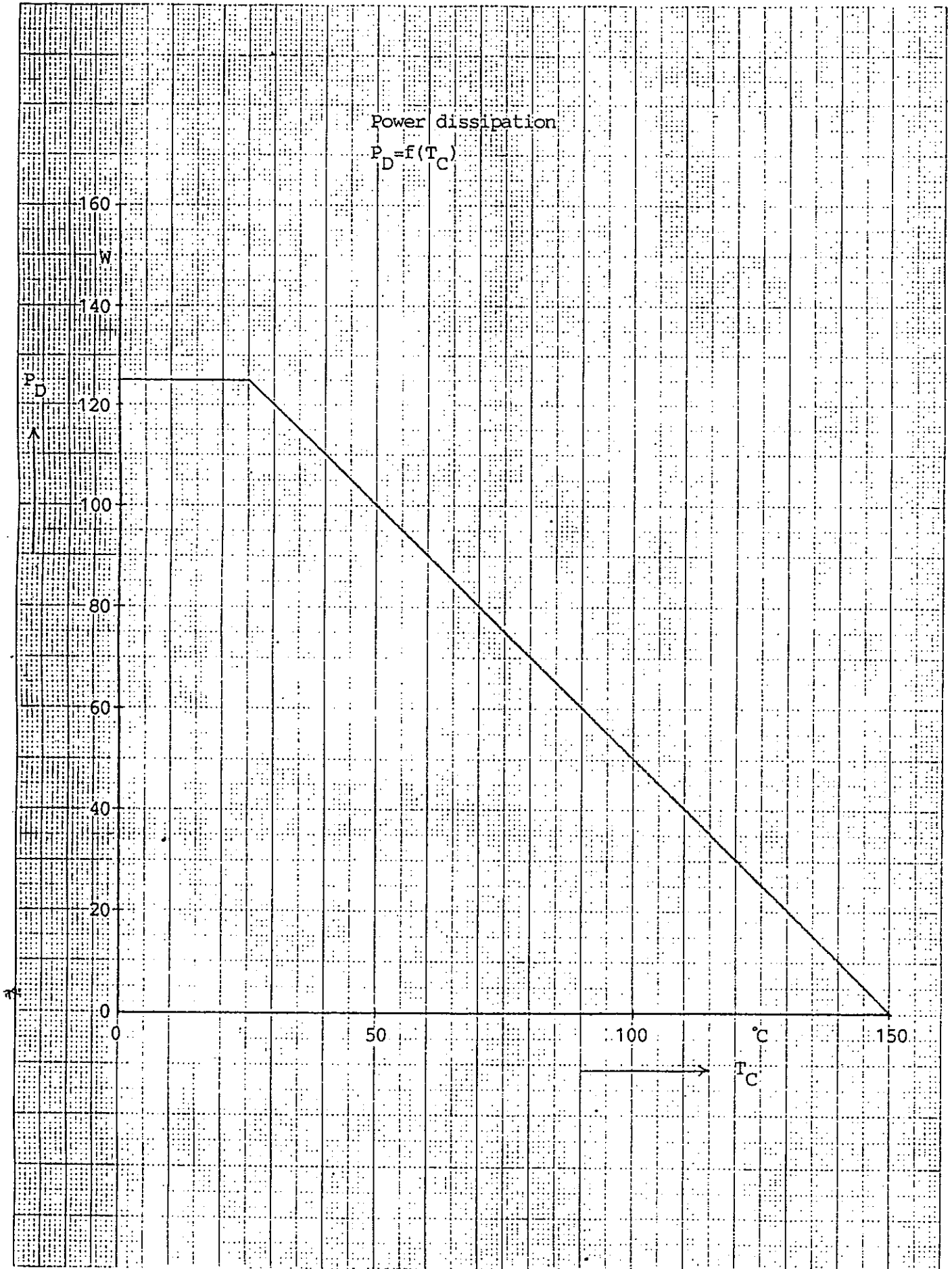

JIS A4 180 × 250mm

MT5F1764

4/15

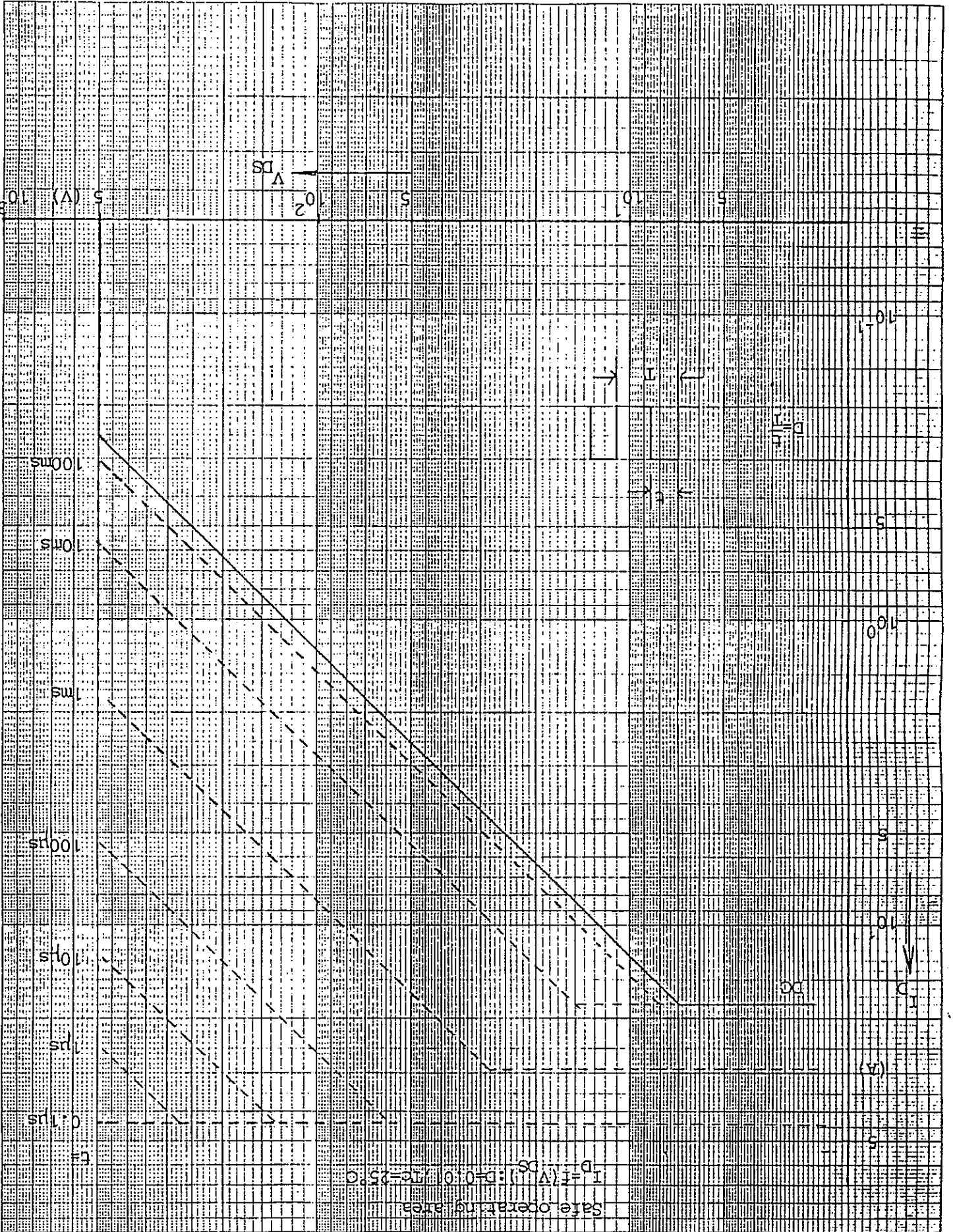

Safe operating area
 $I = I(V_{DS}) = 0.0176 - 25.0$
 $V_{DS} = 100$

Typical output characteristics

$I_D = f(V_{DS})$: 80 μ s pulse test, $T_j = 25^\circ\text{C}$

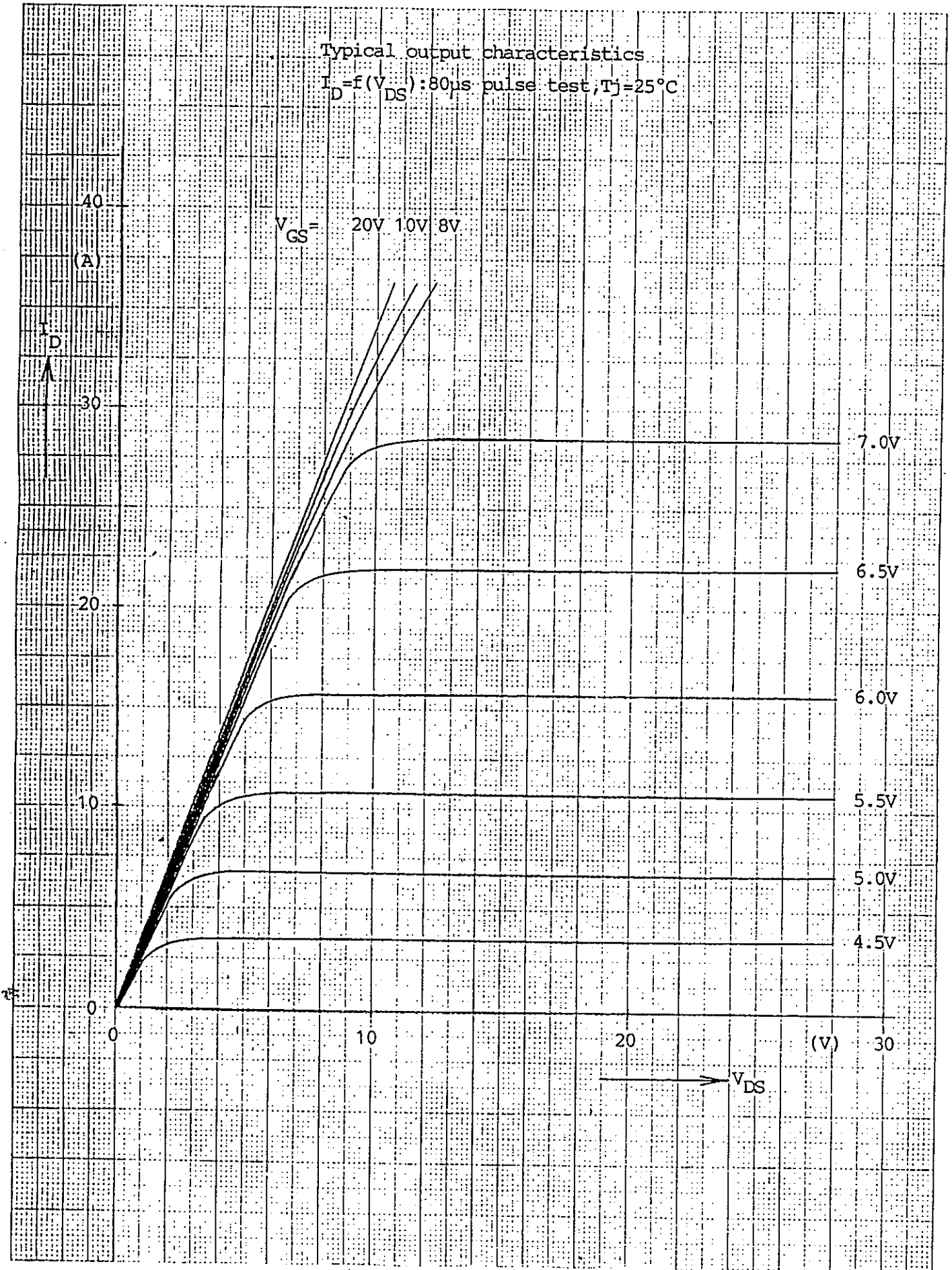

JIS A4 120 x 250mm

MY5F1764

6/15

Typical transfer characteristics

$I_D = f(V_{GS})$: 80 μ s pulse test, $V_{DS} = 25V$, $T_J = 25^\circ C$

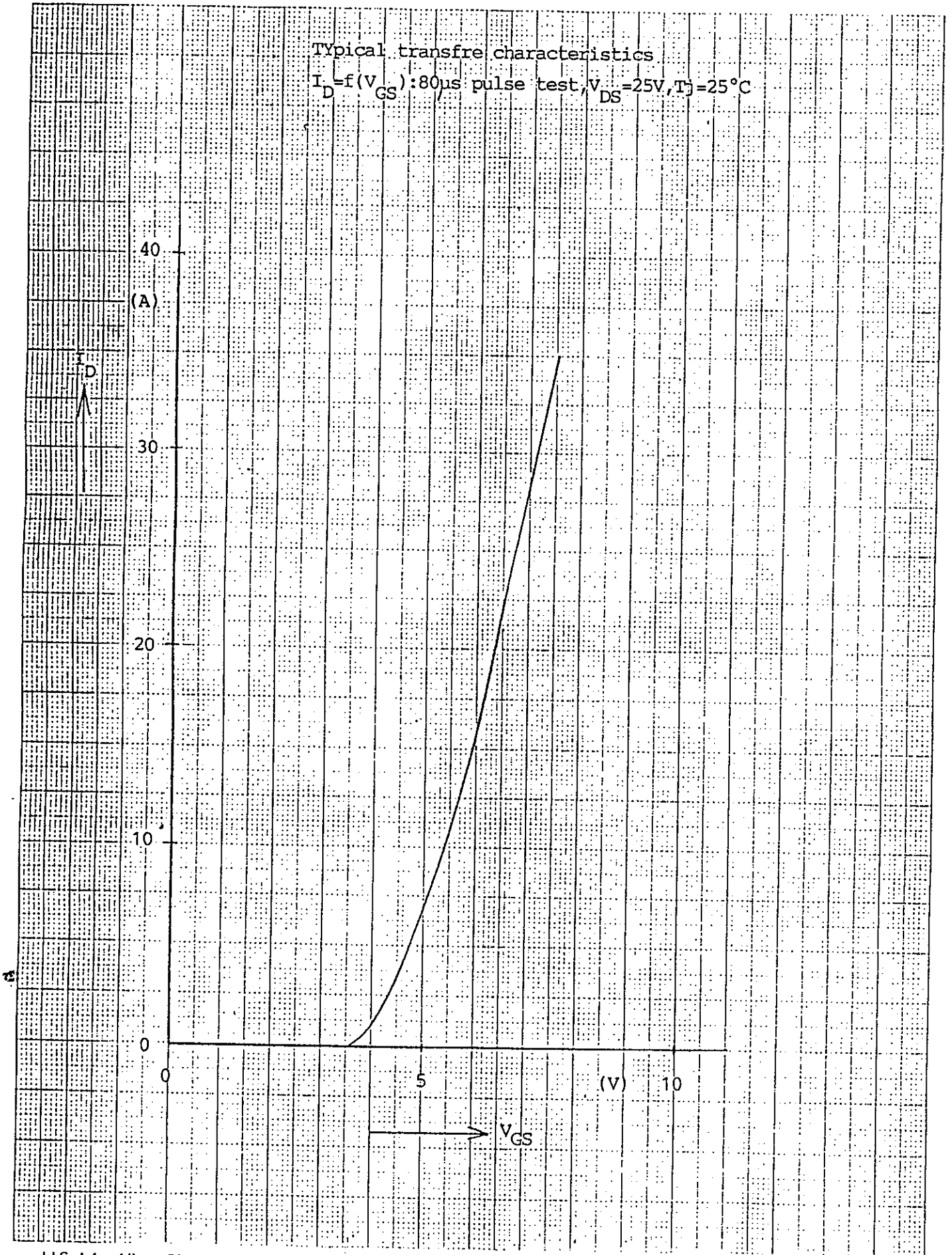

JIS A4 180 250mm

MT5F1764

7/15

Typical transconductance

$g_{fs} = f(I_D)$: 80 μ s pulse test, $V_{DS} = 25V$, $T_J = 25^\circ C$

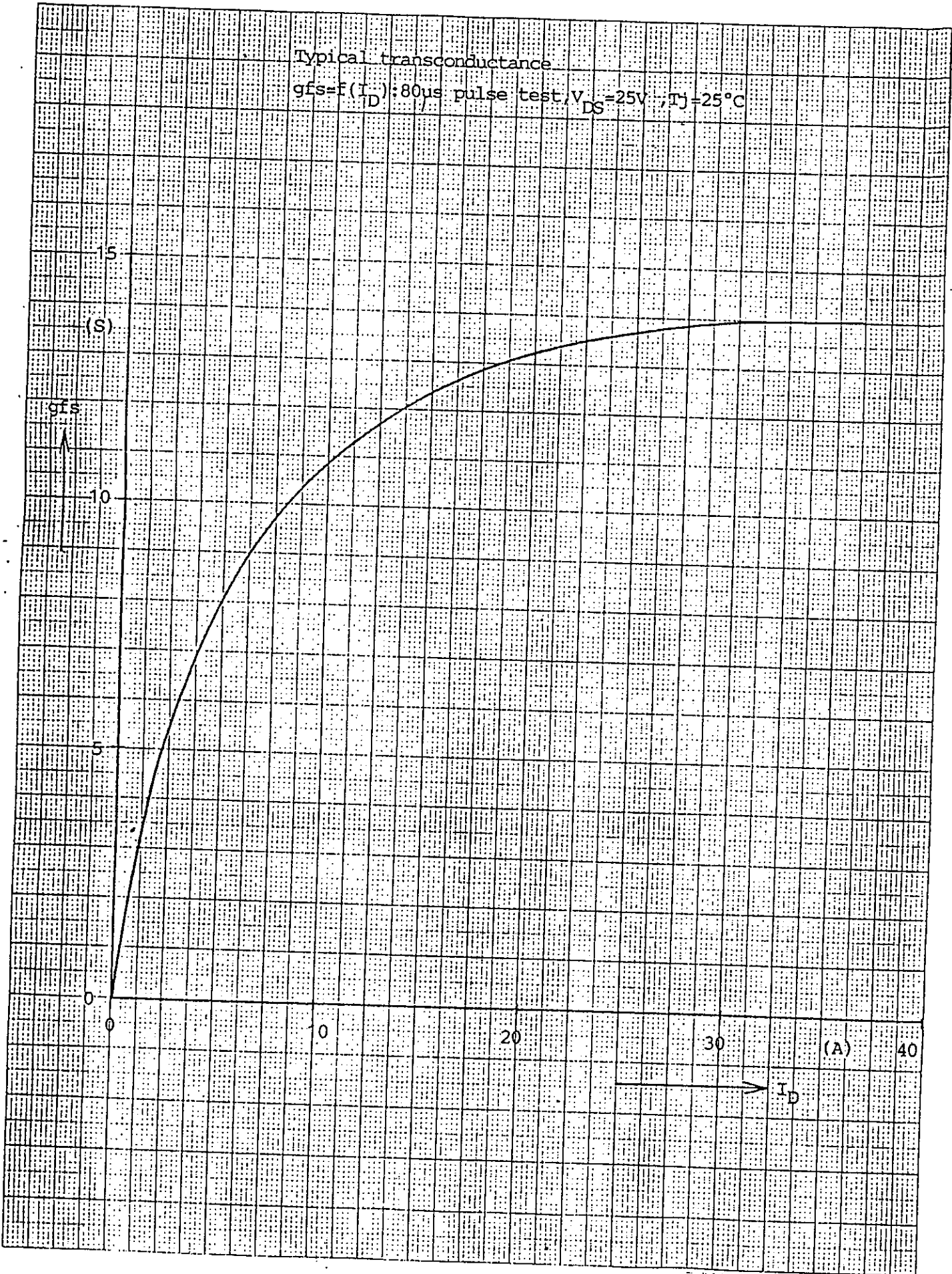

Typical drain-source on-state resistance

$$R_{DS(on)} = f(I_D): V_{GS}, T_J = 25^\circ\text{C}$$

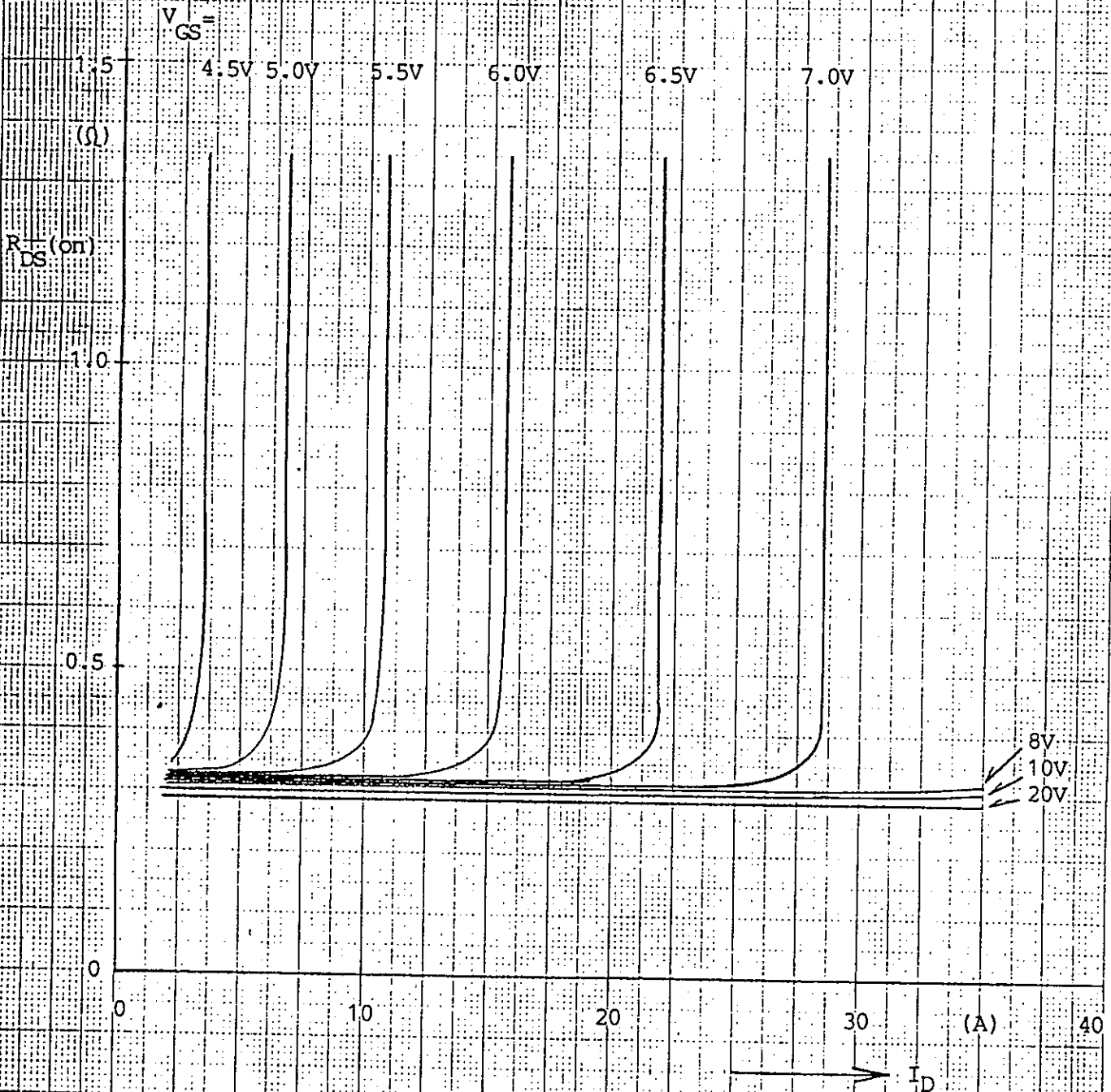

JIS A4 180 x 250mm

MT5F1764

9/15

Drain-source on-state resistance

$$R_{DS(on)} = f(T_j): I_D = 8A, V_{GS} = 10V$$

1.5
(Ω)

$R_{DS(on)}$



1.0

0.5

0

-50

0

50

100

($^{\circ}C$)

150

Max.

Typ.

T_j

MT5F1764

10/15

4

Gate threshold voltage

$$V_{GS(th)} = f(T_J); I_D = 1\text{mA}, V_{DS} = V_{GS}$$

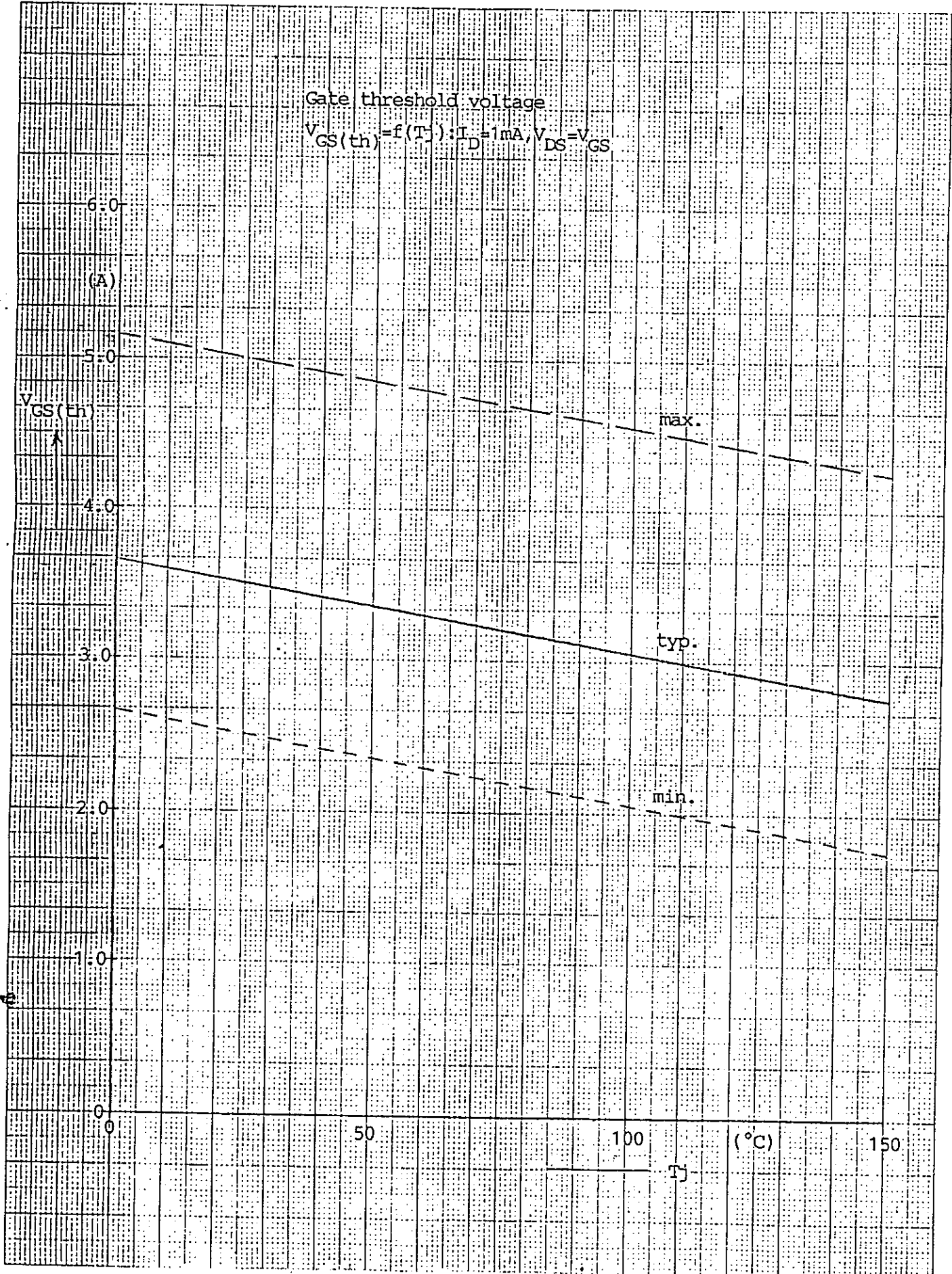

JIS A4 180 x 250mm

MT5F1764

11/15

Typical gate charge characteristics

$V_{GS} = f(Q_g) : I_D = 18A$

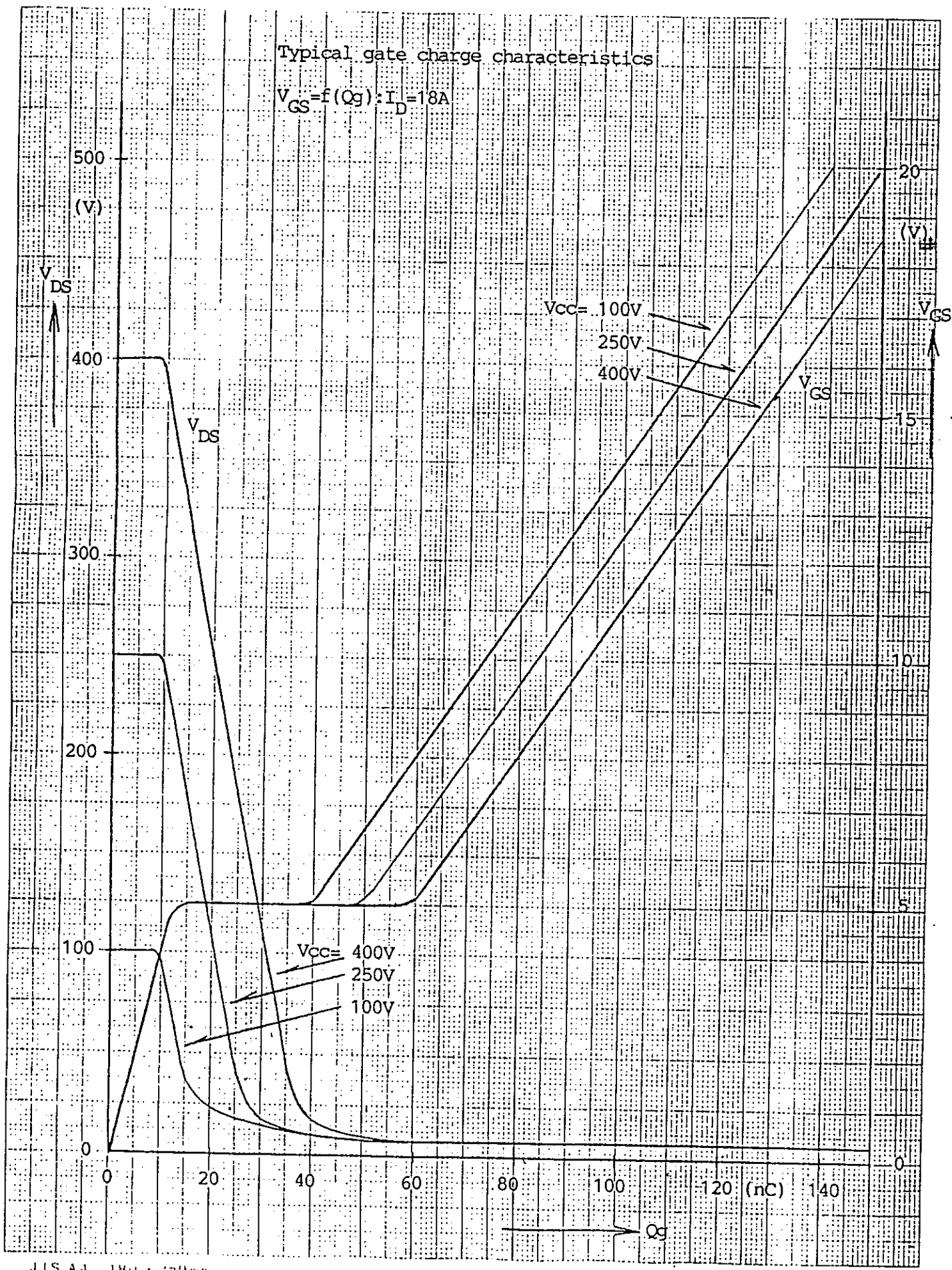

JIS A4 180 - 250mm

Typical capacitances
 $C=f(V_{DS}): V_{GS}=0V, f=1MHz$

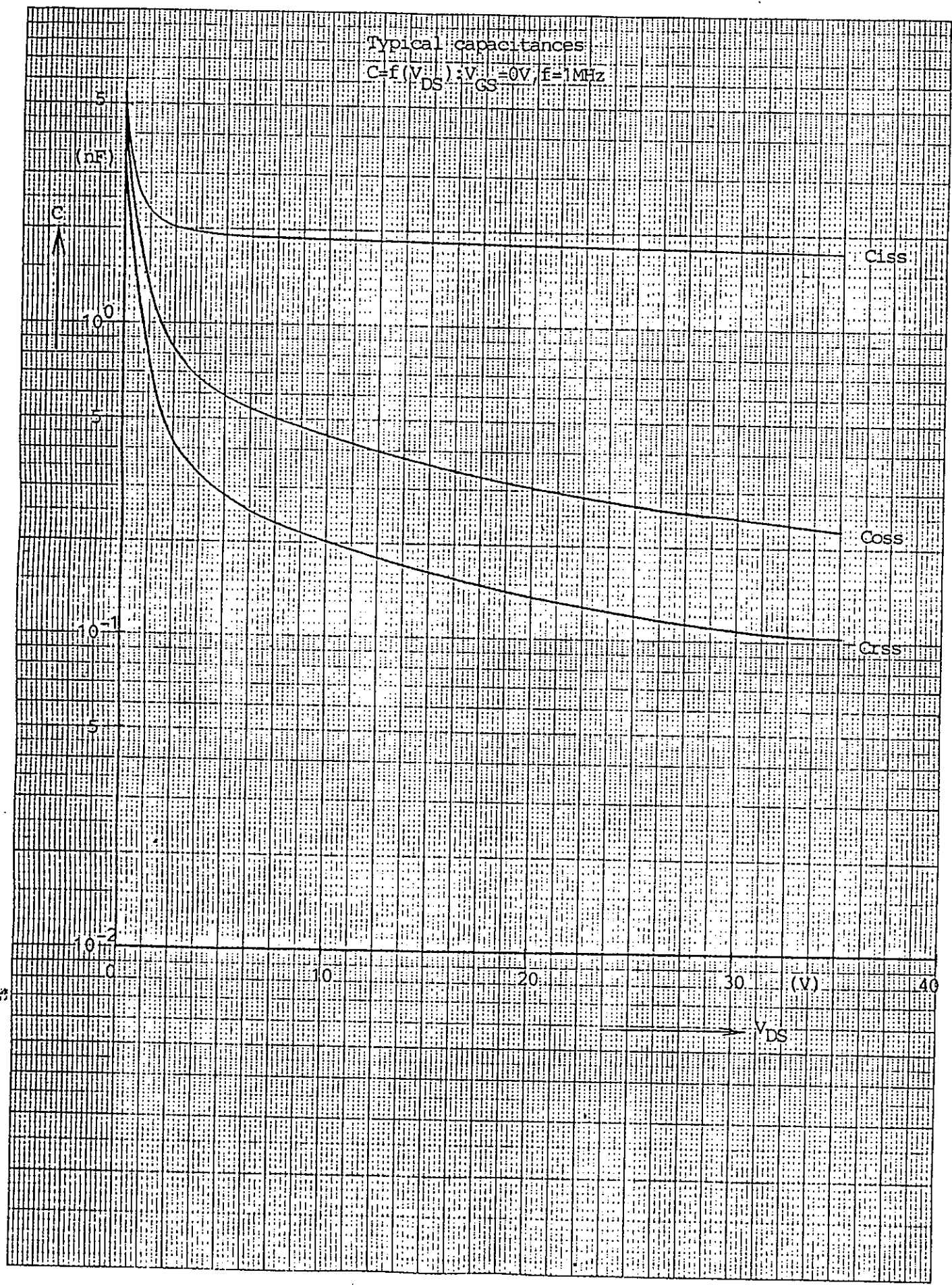

Forward characteristic of reverse diode
 $I_F = f(V_{SD})$: 80 μ s pulse test

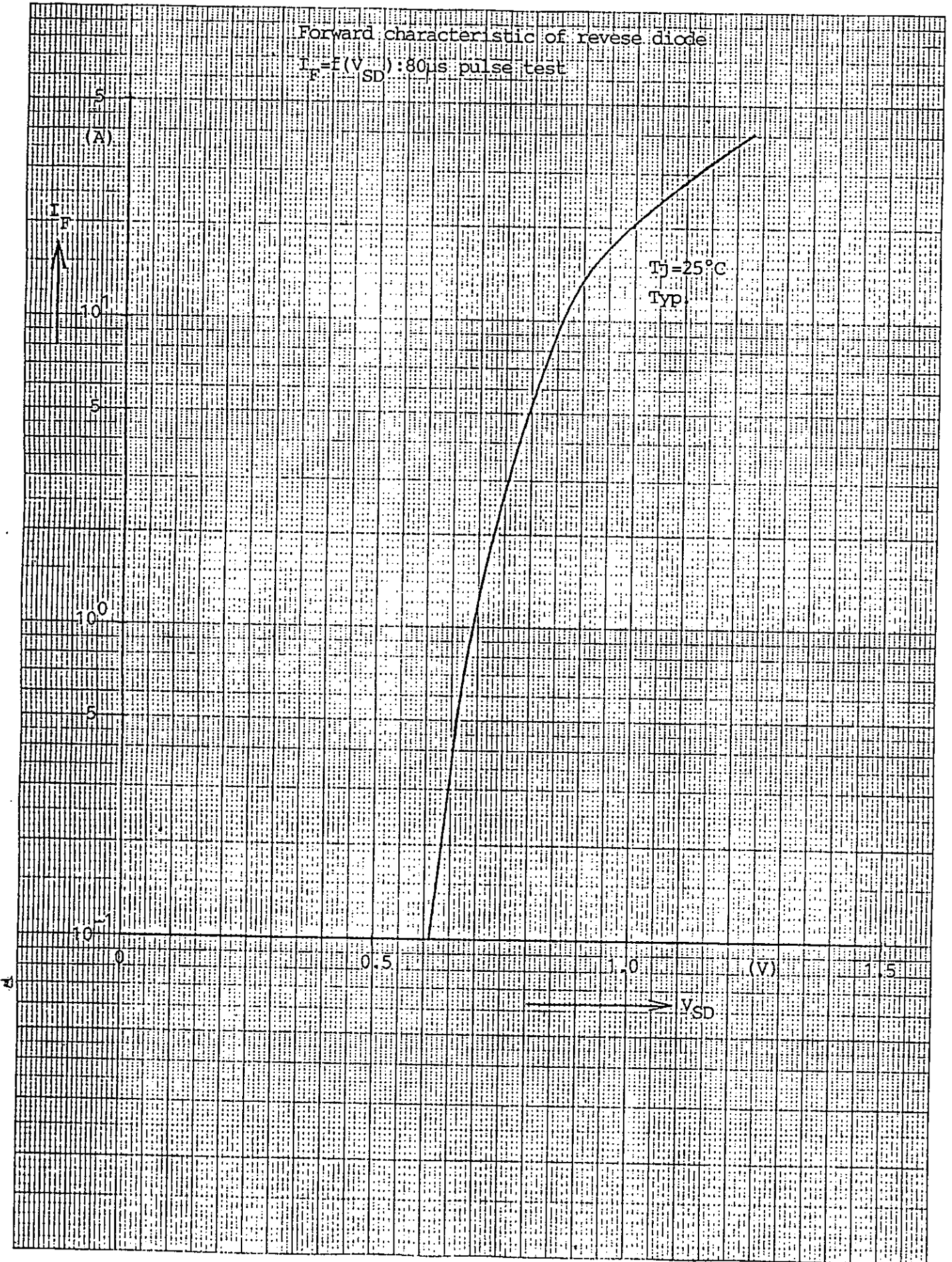

MT5F1764

14/15

Transient thermal
Impedance $Z_{thjc} = f(t)$
parameter: $D = c/T$

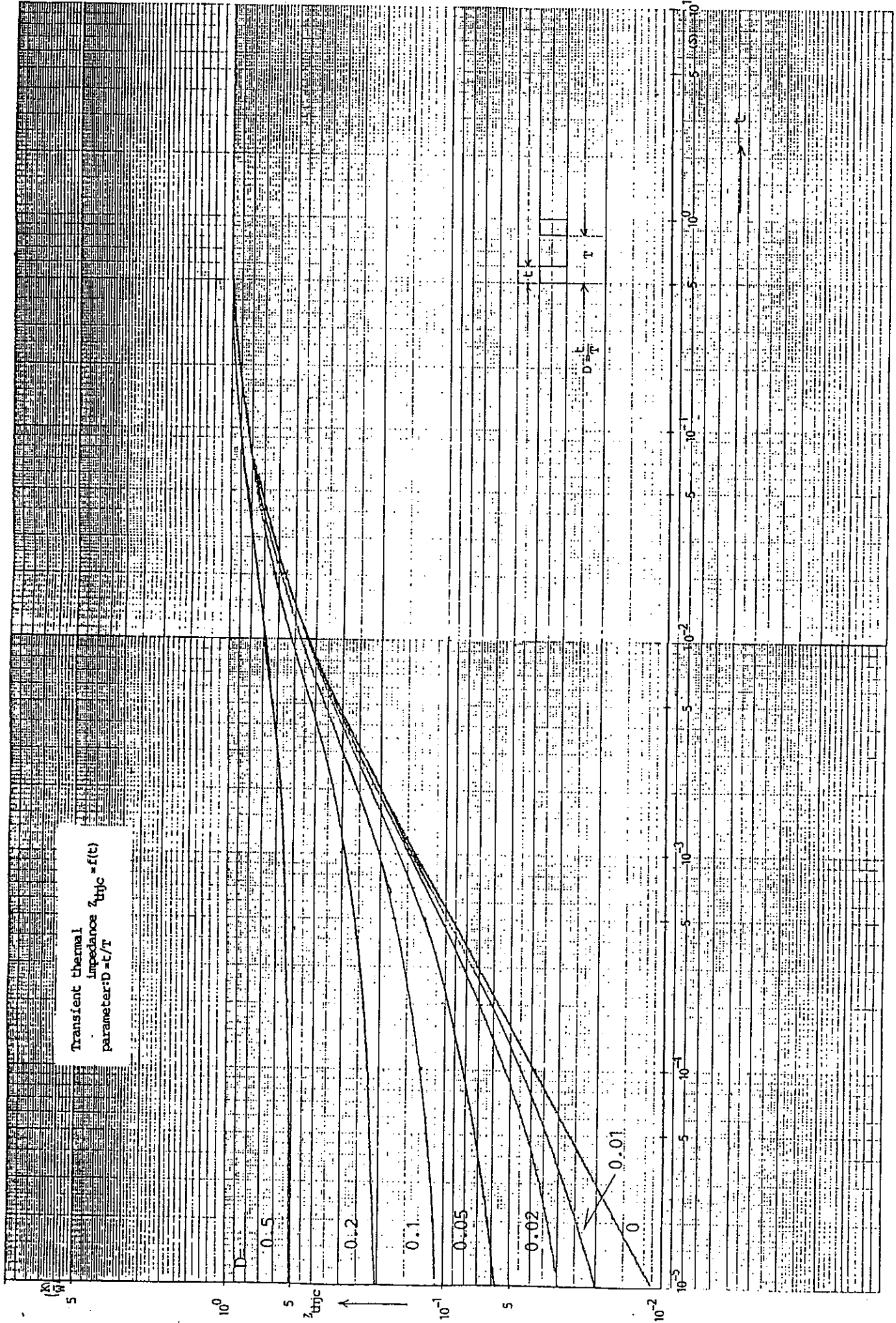

MT5F1764

15/15

FUJI POWER MOS FET

TYPE : 2SK1018

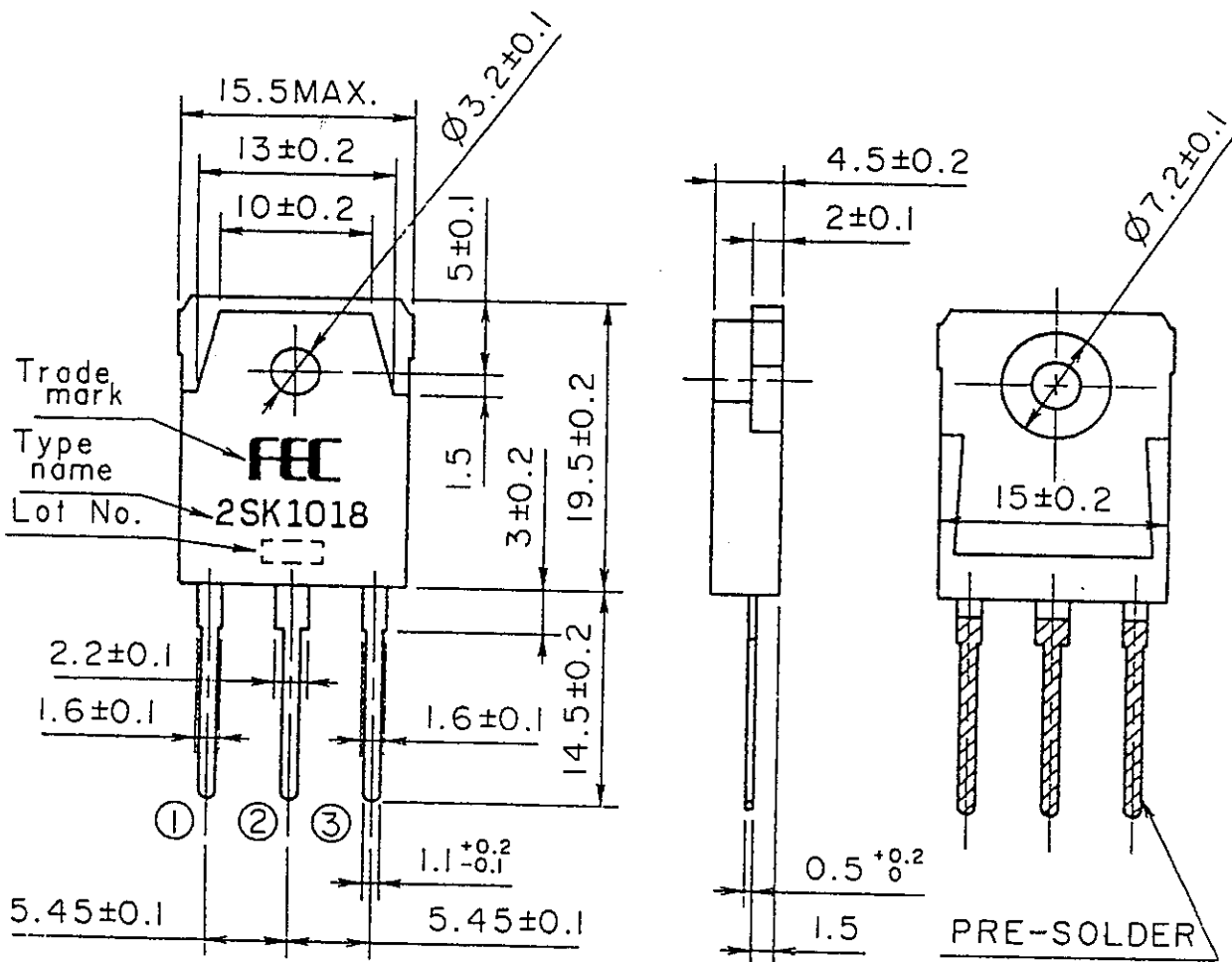

DIMENSIONS ARE IN MILLIMETERS.

CONNECTION

- ① GATE
- ② DRAIN
- ③ SOURCE

JEDEC : TO-228AA
EIAJ : SC-65

MS.T03P.2SK1018-E

Fuji Electric Co.,Ltd.

MK5C24562

This material and the information herein is the property of Fuji Electric Co., Ltd. They shall be neither reproduced, copied, lent, or disclosed in any way whatsoever for the use of any third party nor used for the manufacturing purposes without the express written consent of Fuji Electric Co., Ltd.

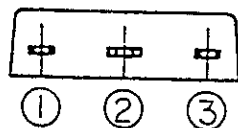

	DATE	NAME	APPROVED
DRAWN	1990-02-16	MARUYAMA	
CHECKED	1990-02-16	ARA I	
REVISIONS			

DWG. NO.