

MOS FIELD EFFECT POWER TRANSISTOR
2SK1282, 1282-Z

SWITCHING
 N-CHANNEL POWER MOS FET
 INDUSTRIAL USE

DESCRIPTION

The 2SK1282/1282-Z is N-channel MOS Field Effect Transistor designed for solenoid, motor and lamp driver.

FEATURES

- Low On-state Resistance
 $R_{DS(on)} \leq 0.18 \Omega$ ($V_{GS} = 10 V, I_D = 2 A$)
 $R_{DS(on)} \leq 0.24 \Omega$ ($V_{GS} = 4 V, I_D = 2 A$)
- Low C_{iss} $C_{iss} = 500 pF$ TYP.
- Built-in G-S Gate Protection Diodes

QUALITY GRADE

Standard
 Please refer to "Quality grade on NEC Semiconductor Devices" (Document number IEI-1209) published by NEC Corporation to know the specification of quality grade on the devices and its recommended applications.

ABSOLUTE MAXIMUM RATINGS ($T_a = 25^\circ C$)

Drain to Source Voltage	V_{DSS}	60	V
Gate to Source Voltage	$V_{GSS(AC)}$	± 20	V
Drain Current (DC)	$I_{D(DC)}$	± 3.0	A
Drain Current (pulse)	$I_{D(pulse)^*}$	± 12	A
Total Power Dissipation ($T_a = 25^\circ C$)	P_{T1}	1.0	W
Total Power Dissipation ($T_c = 20^\circ C$)	P_{T2}	20	W
Channel Temperature	T_{ch}	150	$^\circ C$
Storage Temperature	T_{stg}	-55 to +150	$^\circ C$

* $PW \leq 10 \mu s$, Duty Cycle $\leq 1\%$

PACKAGE DIMENSIONS
 (in millimeters)

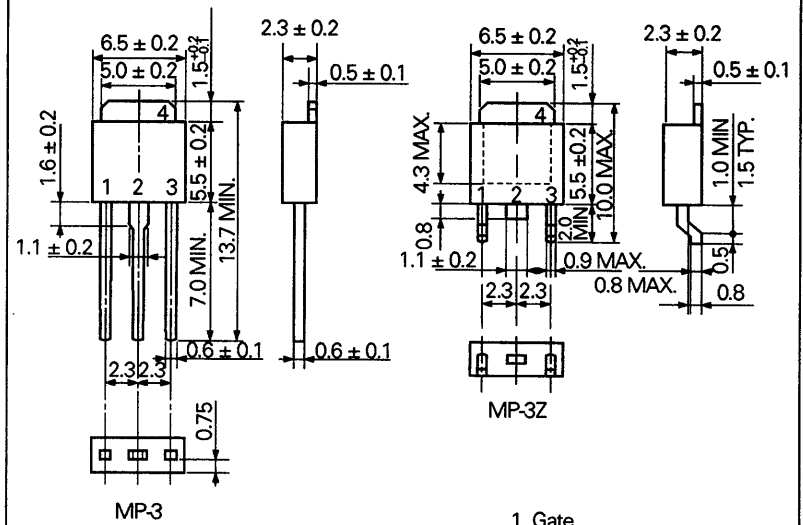

1. Gate
2. Drain
3. Source
4. Fin (Drain)

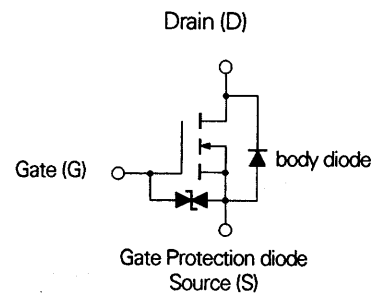

ELECTRICAL CHARACTERISTICS (T_a = 25 °C)

CHARACTERISTIC	SYMBOL	MIN.	TYP.	MAX.	UNIT	TEST CONDITIONS
Drain to Source On-state Resistance	R _{DS(on)}		0.15	0.18	Ω	V _{GS} = 10 V, I _D = 2 A
Drain to Source On-state Resistance	R _{DS(on)}		0.18	0.24	Ω	V _{GS} = 4.0 V, I _D = 2 A
Gate to Source Cutoff Voltage	V _{GS(off)}	1.0		2.5	V	V _{DS} = 10 V, I _D = 1 mA
Forward Transfer Admittance	y _{fs}	2.4			S	V _{DS} = 10 V, I _D = 2 A
Drain Leakage Current	I _{DSS}			10	μA	V _{DS} = 60 V, V _{GS} = 0
Gate to Source Leakage Current	I _{GSS}			±10	μA	V _{GS} = ±20 V, V _{DS} = 0
Input Capacitance	C _{ies}		500		pF	V _{DS} = 10 V
Output Capacitance	C _{oss}		200		pF	V _{GS} = 0
Reverse Transfer Capacitance	C _{rss}		40		pF	f = 1 MHz
Turn-On Delay Time	t _{d(on)}		40		ns	V _{GS(on)} = 10 V
Rise Time	t _r		100		ns	V _{DD} = 30 V
Turn-Off Delay Time	t _{d(off)}		550		ns	I _D = 2 A, R _G = 10 Ω
Fall Time	t _f		200		ns	R _L = 15 Ω
Total Gate Charge	Q _G		13		nC	V _{GS} = 10 V
Gate to Source Charge	Q _{GS}		3		nC	I _D = 3 A
Gate to Drain Charge	Q _{GD}		3		nC	V _{DD} = 48 V
Diode Forward Voltage	V _{SD}		0.9		V	I _{SD} = 3 A, V _{GS} = 0
Reverse Recovery Time	t _{rr}		140		ns	I _F = 3 A, V _{GS} = 0
Reverse Recovery Charge	Q _{rr}		700		nC	di/dt = 50 A/μs

Test Circuit 1: Switching Time

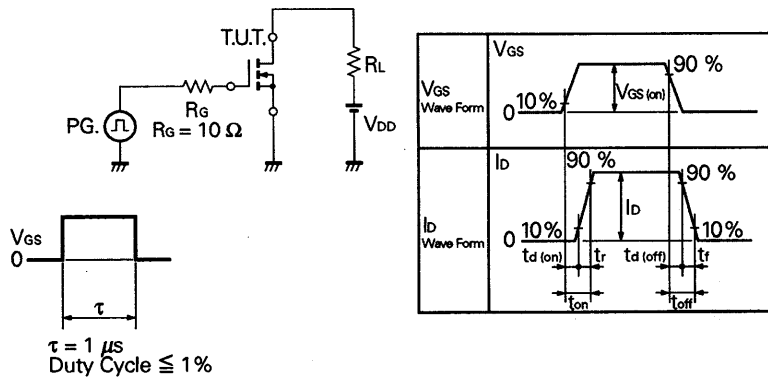

Test Circuit 2: Gate Charge

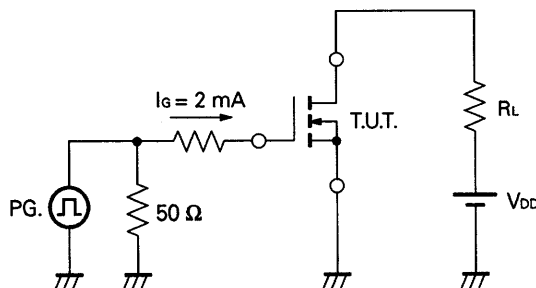

TYPICAL CHARACTERISTICS ($T_a = 25\text{ }^\circ\text{C}$)

DERATING FACTOR OF FORWARD BIAS SAFE OPERATING AREA

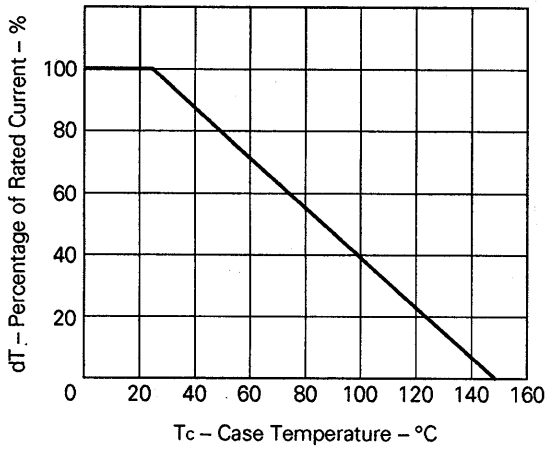

TOTAL POWER DISSIPATION vs. CASE TEMPERATURE

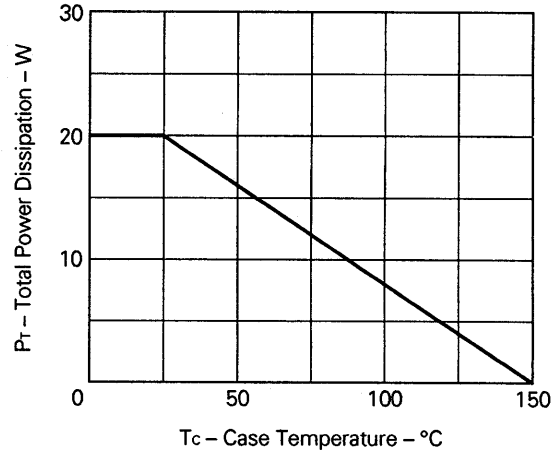

FORWARD BIAS SAFE OPERATING AREA

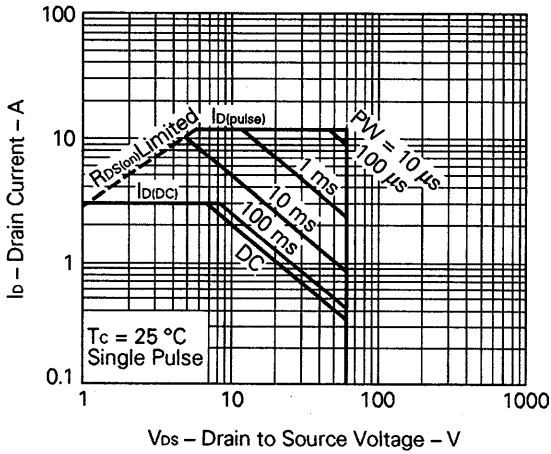

DRAIN CURRENT vs. DRAIN TO SOURCE VOLTAGE

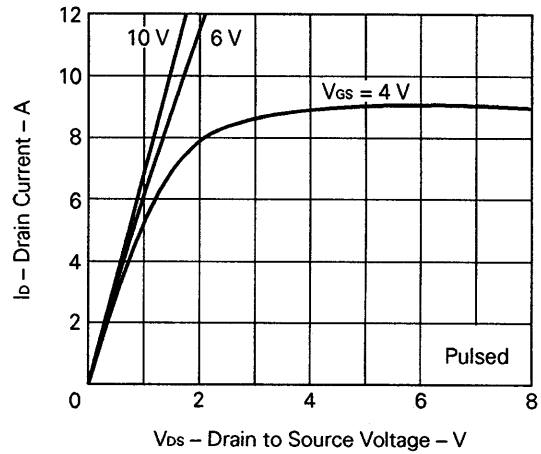

TRANSFER CHARACTERISTICS

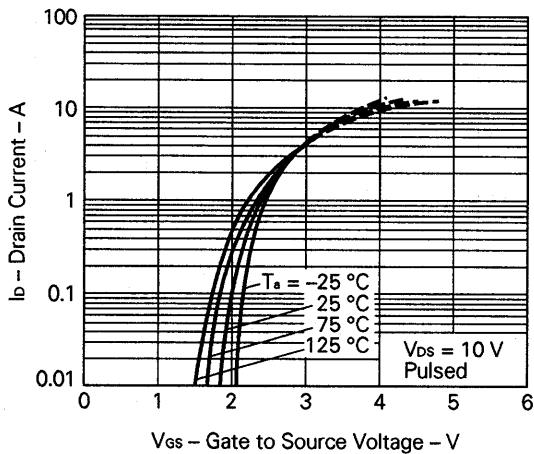

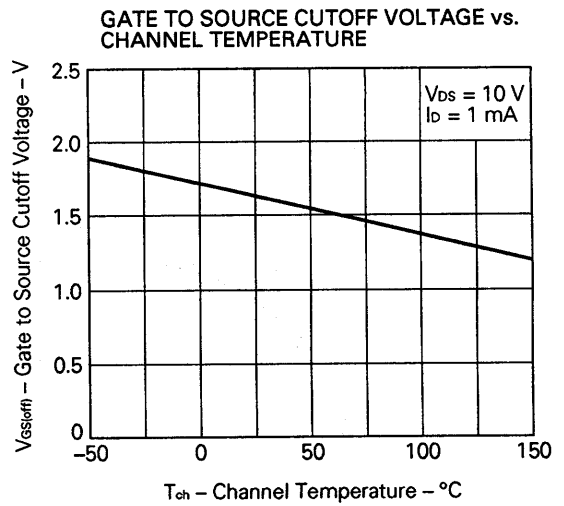
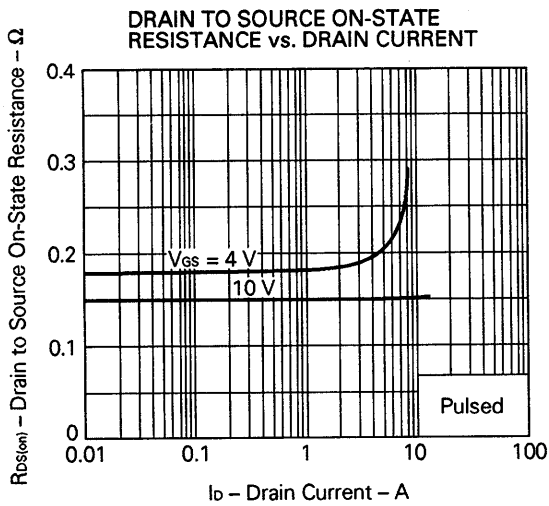
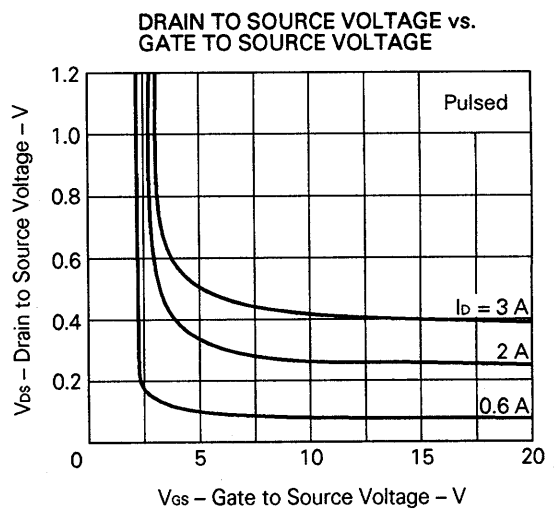
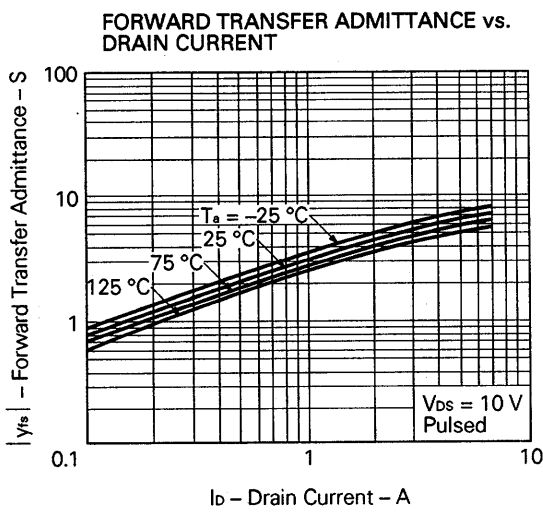
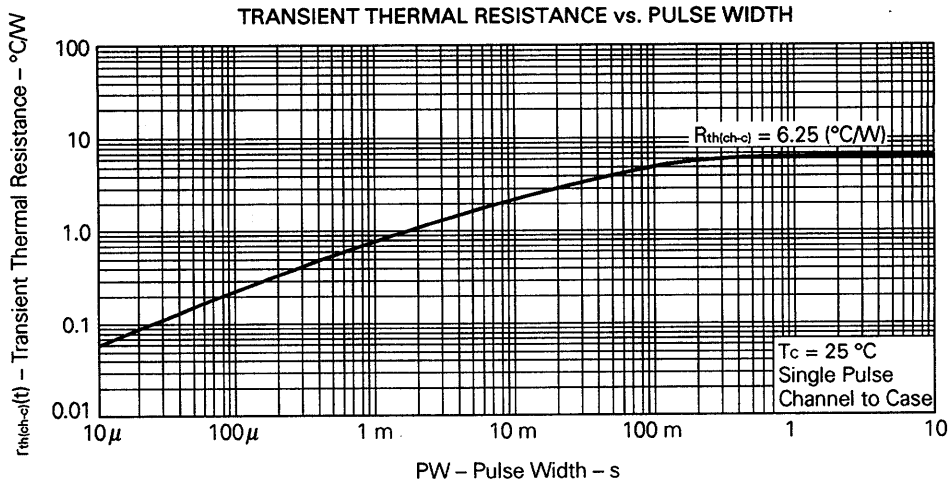

DRAIN TO SOURCE ON-STATE RESISTANCE vs. CHANNEL TEMPERATURE

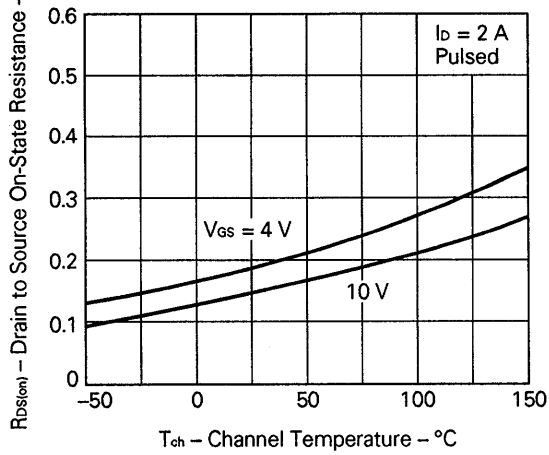

SOURCE TO DRAIN DIODE vs. FORWARD VOLTAGE

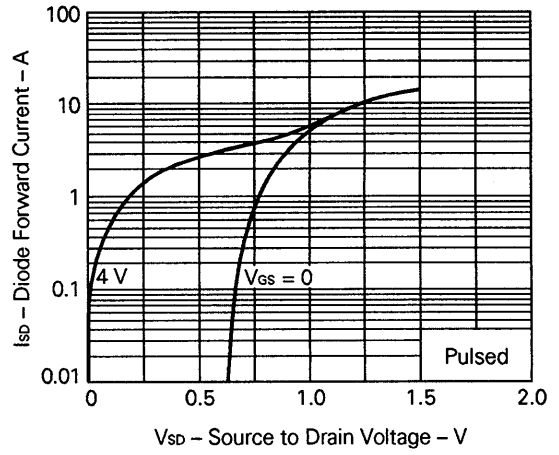

CAPACITANCE vs. DRAIN TO SOURCE VOLTAGE

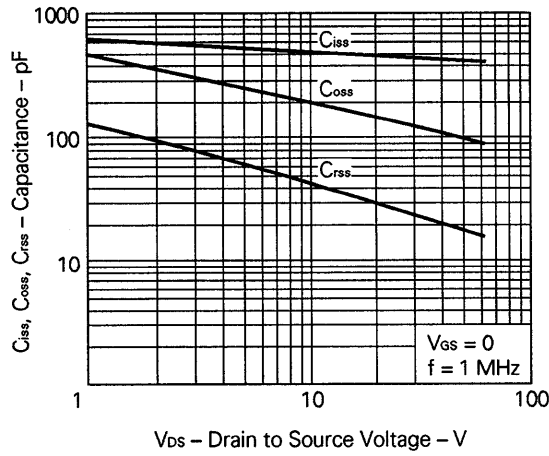

SWITCHING CHARACTERISTICS

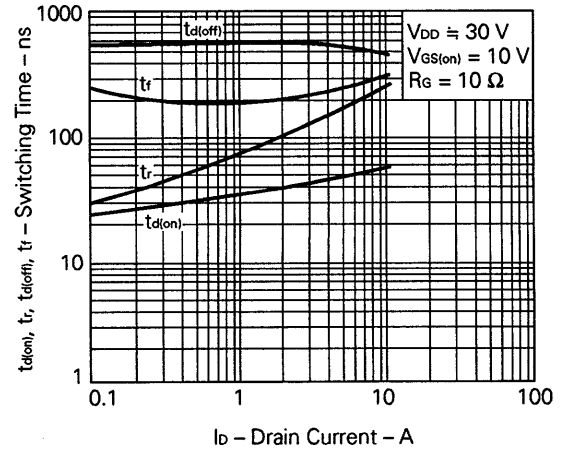

DYNAMIC INPUT CHARACTERISTICS

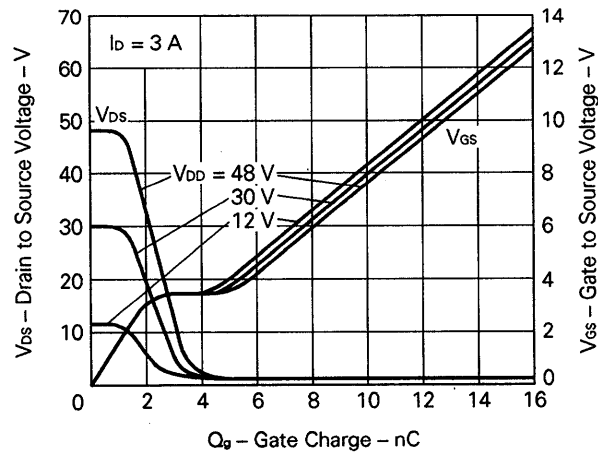

REVERSE RECOVERY TIME vs. DIODE FORWARD CURRENT

