

isc N-Channel MOSFET Transistor
2SK1633
DESCRIPTION

- Drain Current $-I_D = 5A @ T_C = 25^\circ C$
- Drain Source Voltage-
: $V_{DSS} = 700V(\text{Min})$
- Minimum Lot-to-Lot variations for robust device performance and reliable operation

APPLICATIONS

- Designed for high voltage, high speed power switching applications such as switching regulators, converters, solenoid and relay drivers.

ABSOLUTE MAXIMUM RATINGS ($T_a = 25^\circ C$)

SYMBOL	PARAMETER	VALUE	UNIT
V_{DSS}	Drain-Source Voltage ($V_{GS} = 0$)	700	V
V_{GS}	Gate-Source Voltage	± 30	V
I_D	Drain Current-continuous@ $T_C = 25^\circ C$	5	A
P_{tot}	Total Dissipation@ $T_C = 25^\circ C$	45	W
T_j	Max. Operating Junction Temperature	150	$^\circ C$
T_{stg}	Storage Temperature Range	-55~150	$^\circ C$

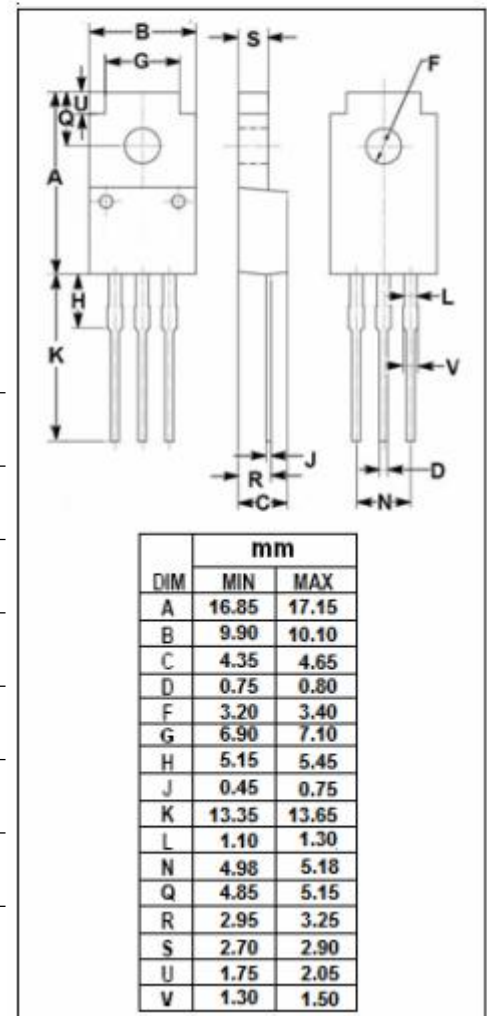
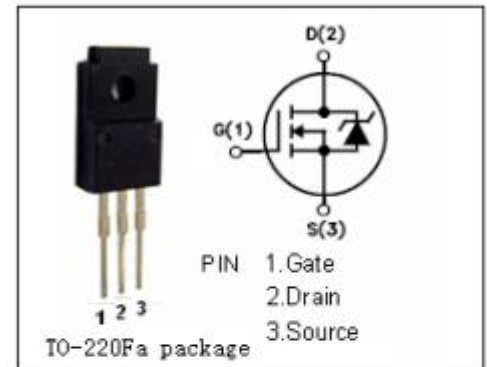

isc N-Channel Mosfet Transistor

2SK1633

• ELECTRICAL CHARACTERISTICS (T_c=25°C)

SYMBOL	PARAMETER	CONDITIONS	MIN	TYP	MAX	UNIT
V _{(BR)DSS}	Drain-Source Breakdown Voltage	V _{GS} =0; I _D = 10mA	700			V
V _{GS(th)}	Gate Threshold Voltage	V _{DS} =10 V _{GS} ; I _D =1mA	2.0	3.0	4.0	V
R _{DS(on)}	Drain-Source On-stage Resistance	V _{GS} =10V; I _D =3A			2.3	Ω
I _{GSS}	Gate Source Leakage Current	V _{GS} = ±30V; V _{DS} = 0			± 100	nA
I _{DSS}	Zero Gate Voltage Drain Current	V _{DS} =700V; V _{GS} = 0			500	uA

NOTICE:

ISC reserves the rights to make changes of the content herein the datasheet at any time without notification. The information contained herein is presented only as a guide for the applications of our products.

ISC products are intended for usage in general electronic equipment. The products are not designed for use in equipment which require specialized quality and/or reliability, or in equipment which could have applications in hazardous environments, aerospace industry, or medical field. Please contact us if you intend our products to be used in these special applications.

ISC makes no warranty or guarantee regarding the suitability of its products for any particular purpose, nor does ISC assume any liability arising from the application or use of any products, and specifically disclaims any and all liability, including without limitation special, consequential or incidental damages.