

> **Features**

- High Speed Switching
- Low On-Resistance
- No Secondary Breakdown
- Low Driving Power
- High Voltage
- $V_{GS} = \pm 30V$ Guarantee
- Avalanche Proof

> **Applications**

- Switching Regulators
- UPS
- DC-DC converters
- General Purpose Power Amplifier

> **Outline Drawing**

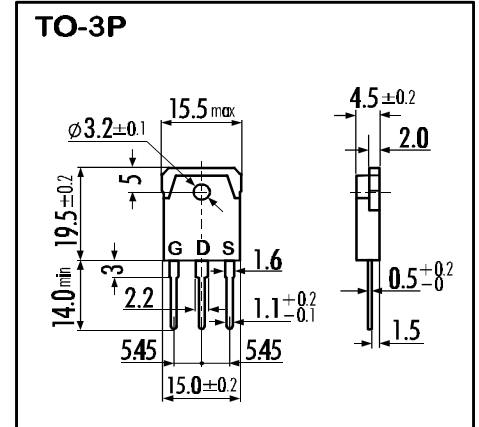

> **Maximum Ratings and Characteristics**

- Absolute Maximum Ratings ($T_C=25^\circ C$), unless otherwise specified

| Item | Symbol | Rating | Unit |
|---|---------------|------------|------------|
| Drain-Source-Voltage | V_{DS} | 500 | V |
| Drain-Gate-Voltage ($R_{GS}=20K\Omega$) | V_{DGR} | 500 | V |
| Continous Drain Current | I_D | 10 | A |
| Pulsed Drain Current | $I_{D(puls)}$ | 40 | A |
| Gate-Source-Voltage | V_{GS} | ± 30 | V |
| Max. Power Dissipation | P_D | 100 | W |
| Operating and Storage Temperature Range | T_{ch} | 150 | $^\circ C$ |
| | T_{stg} | -55 ~ +150 | $^\circ C$ |

> **Equivalent Circuit**



- Electrical Characteristics ($T_C=25^\circ C$), unless otherwise specified

| Item | Symbol | Test conditions | Min. | Typ. | Max. | Unit |
|--|---------------|---|------|------|------|----------|
| Drain-Source Breakdown-Voltage | $V_{(BR)DSS}$ | $I_D=1mA$ $V_{GS}=0V$ | 500 | | | V |
| Gate Threshold Voltage | $V_{GS(th)}$ | $I_D=1mA$ $V_{DS}=V_{GS}$ | 2,5 | 3,0 | 3,5 | V |
| Zero Gate Voltage Drain Current | I_{DSS} | $V_{DS}=500V$ $T_{ch}=25^\circ C$ | | 10 | 500 | μA |
| | | $V_{GS}=0V$ $T_{ch}=125^\circ C$ | | 0,2 | 1,0 | mA |
| Gate Source Leakage Current | I_{GSS} | $V_{GS}=\pm 30V$ $V_{DS}=0V$ | | 10 | 100 | nA |
| Drain Source On-State Resistance | $R_{DS(on)}$ | $I_D=5A$ $V_{GS}=10V$ | | 0,6 | 0,76 | Ω |
| Forward Transconductance | g_{fs} | $I_D=5A$ $V_{DS}=25V$ | 5,0 | 10,0 | | S |
| Input Capacitance | C_{iss} | $V_{DS}=25V$ | | 1500 | 2200 | pF |
| Output Capacitance | C_{oss} | $V_{GS}=0V$ | | 160 | 240 | pF |
| Reverse Transfer Capacitance | C_{rss} | $f=1MHz$ | | 35 | 50 | pF |
| Turn-On-Time t_{on} ($t_{on}=t_{d(on)}+t_r$) | $t_{d(on)}$ | $V_{CC}=300V$ | | 15 | 25 | ns |
| | | $I_D=10A$ | | 40 | 60 | ns |
| Turn-Off-Time t_{off} ($t_{off}=t_{d(off)}+t_f$) | $t_{d(off)}$ | $V_{GS}=10V$ | | 70 | 100 | ns |
| | | $R_{GS}=10\Omega$ | | 60 | 90 | ns |
| Avalanche Capability | I_{AV} | $L=100\mu H$ $T_{ch}=25^\circ C$ | 10 | | | A |
| Continous Reverse Drain Current | I_{DR} | | | | 10 | A |
| Pulsed Reverse Drain Current | I_{DRM} | | | | 40 | A |
| Diode Forward On-Voltage | V_{SD} | $I_F=2I_{DR}$ $V_{GS}=0V$ $T_{ch}=25^\circ C$ | | 1,12 | 1,70 | V |
| Reverse Recovery Time | t_{rr} | $I_F=I_{DR}$ $V_{GS}=0V$ | | 450 | | ns |
| Reverse Recovery Charge | Q_{rr} | $-dI_F/dt=100A/\mu s$ $T_{ch}=25^\circ C$ | | 3 | | μC |

- Thermal Characteristics

| Item | Symbol | Test conditions | Min. | Typ. | Max. | Unit |
|--------------------|----------------|-----------------|------|------|------|--------------|
| Thermal Resistance | $R_{th(ch-a)}$ | channel to air | | | 35 | $^\circ C/W$ |
| | $R_{th(ch-c)}$ | channel to case | | | 1,25 | $^\circ C/W$ |

| | | | |
|-------------------|-------|-----|------|
| N-channel MOS-FET | | | |
| 500V | 0,76Ω | 10A | 100W |

2SK1936-01

FAP-IIA Series



> Characteristics

Typical Output Characteristics

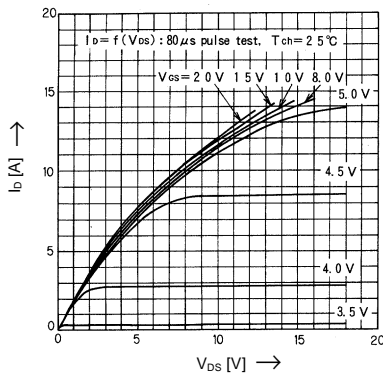

Drain-Source-On-State Resistance vs. T_{ch}

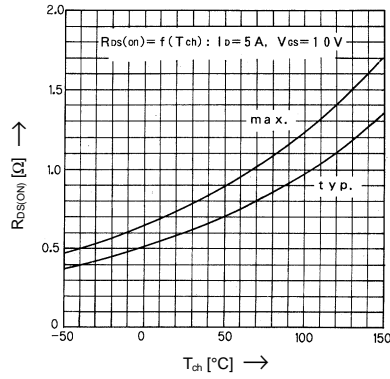

Typical Transfer Characteristics

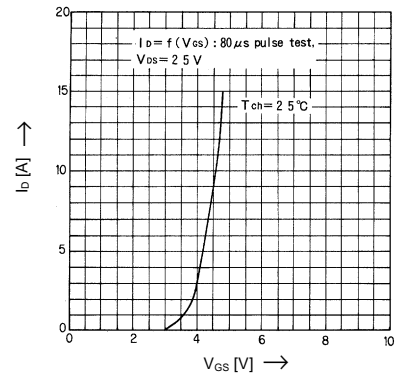

Typical Drain-Source-On-State-Resistance vs. I_D

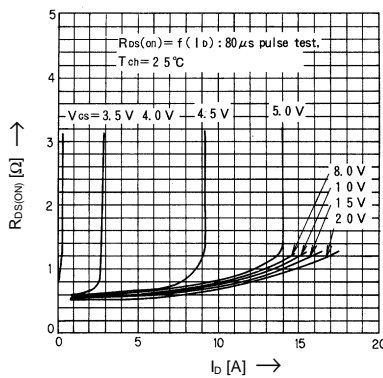

Typical Forward Transconductance vs. I_D

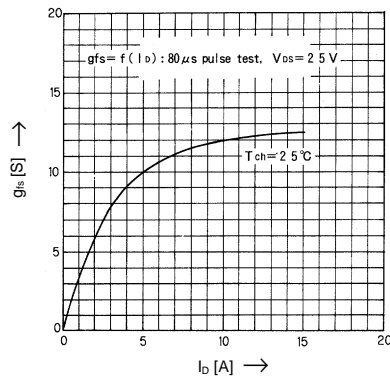

Gate Threshold Voltage vs. T_{ch}

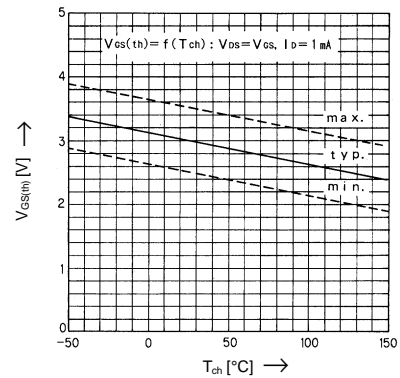

Typical Capacitance vs. V_{DS}

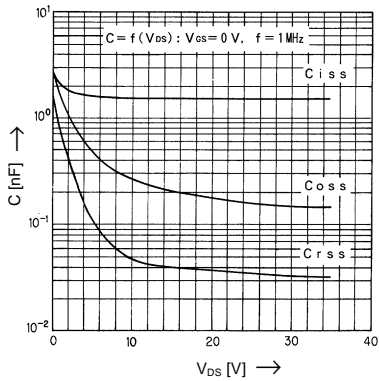

Typical Input Charge

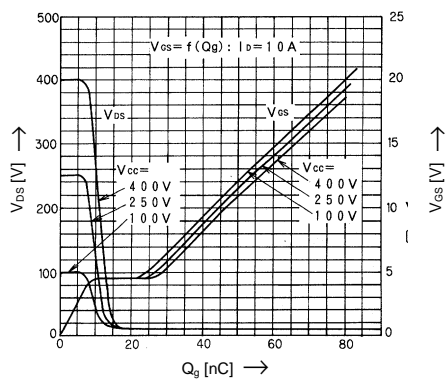

Forward Characteristics of Reverse Diode

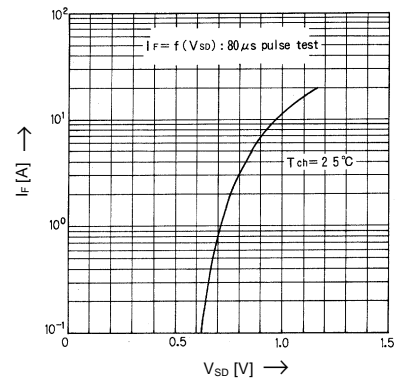

Allowable Power Dissipation vs. T_c

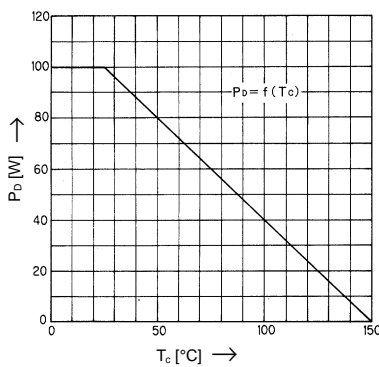

Safe operation area

