

> **Features**

- High Speed Switching
- Low On-Resistance
- No Secondary Breakdown
- Low Driving Power
- High Voltage
- $V_{GS} = \pm 30V$  Guarantee
- Avalanche Proof

> **Applications**

- Switching Regulators
- UPS
- DC-DC converters
- General Purpose Power Amplifier

> **Outline Drawing**

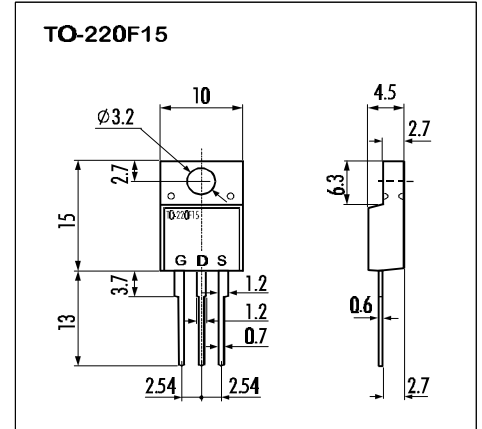

> **Maximum Ratings and Characteristics**

- Absolute Maximum Ratings ( $T_C=25^\circ C$ ), unless otherwise specified

Item	Symbol	Rating	Unit
Drain-Source-Voltage	$V_{DS}$	500	V
Drain-Gate-Voltage( $R_{GS}=20K\Omega$ )	$V_{DGR}$	500	V
Continous Drain Current	$I_D$	5	A
Pulsed Drain Current	$I_{D(puls)}$	20	A
Gate-Source-Voltage	$V_{GS}$	$\pm 30$	V
Max. Power Dissipation	$P_D$	40	W
Operating and Storage Temperature Range	$T_{ch}$	150	$^\circ C$
	$T_{stg}$	-55 ~ +150	$^\circ C$

> **Equivalent Circuit**



- Electrical Characteristics ( $T_C=25^\circ C$ ), unless otherwise specified

Item	Symbol	Test conditions	Min.	Typ.	Max.	Unit
Drain-Source Breakdown-Voltage	$V_{(BR)DSS}$	$I_D=1mA$ $V_{GS}=0V$	500			V
Gate Threshold Voltage	$V_{GS(th)}$	$I_D=1mA$ $V_{DS}=V_{GS}$	2,5	3,0	3,5	V
Zero Gate Voltage Drain Current	$I_{DSS}$	$V_{DS}=500V$ $T_{ch}=25^\circ C$		10	500	$\mu A$
		$V_{GS}=0V$ $T_{ch}=125^\circ C$		0,2	1,0	mA
Gate Source Leakage Current	$I_{GSS}$	$V_{GS}=\pm 30V$ $V_{DS}=0V$		10	100	nA
Drain Source On-State Resistance	$R_{DS(on)}$	$I_D=2,5A$ $V_{GS}=10V$		1,2	1,6	$\Omega$
Forward Transconductance	$g_{fs}$	$I_D=2,5A$ $V_{DS}=25V$	2	4		S
Input Capacitance	$C_{iss}$	$V_{DS}=25V$		1000	1500	pF
Output Capacitance	$C_{oss}$	$V_{GS}=0V$		85	130	pF
Reverse Transfer Capacitance	$C_{rss}$	$f=1MHz$		20	30	pF
Turn-On-Time $t_{on}$ ( $t_{on}=t_{d(on)}+t_r$ )	$t_{d(on)}$	$V_{CC}=300V$ $I_D=5A$		20	30	ns
				15	25	ns
Turn-Off-Time $t_{off}$ ( $t_{off}=t_{d(off)}+t_f$ )	$t_{d(off)}$	$V_{GS}=10V$ $R_{GS}=10\Omega$		45	70	ns
				20	30	ns
Avalanche Capability	$I_{AV}$	$L=100\mu H$ $T_{ch}=25^\circ C$	5			A
Continous Reverse Drain Current	$I_{DR}$				5	A
Pulsed Reverse Drain Current	$I_{DRM}$				20	A
Diode Forward On-Voltage	$V_{SD}$	$I_F=2I_{DR}$ $V_{GS}=0V$ $T_{ch}=25^\circ C$		1,1	1,65	V
Reverse Recovery Time	$t_{rr}$	$I_F=I_{DR}$ $V_{GS}=0V$		400		ns
Reverse Recovery Charge	$Q_{rr}$	$-di_F/dt=100A/\mu s$ $T_{ch}=25^\circ C$		2		$\mu C$

- Thermal Characteristics

Item	Symbol	Test conditions	Min.	Typ.	Max.	Unit
Thermal Resistance	$R_{th(ch-a)}$	channel to air			62,5	$^\circ C/W$
	$R_{th(ch-c)}$	channel to case			3,125	$^\circ C/W$

N-channel MOS-FET			
500V	1,6Ω	5A	40W

# 2SK2022-01M

## FAP-IIA Series



### > Characteristics

Typical Output Characteristics

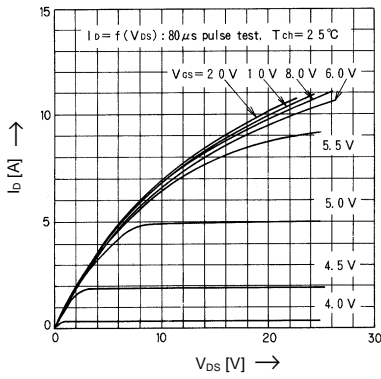

Drain-Source-On-State Resistance vs. Tch

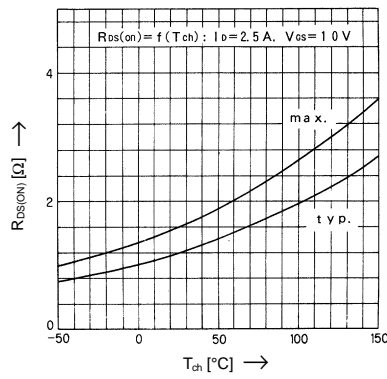

Typical Transfer Characteristics

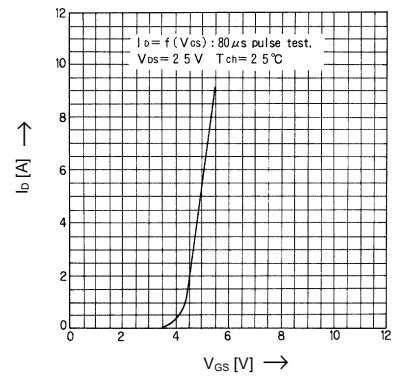

Typical Drain-Source-On-State-Resistance vs. Id

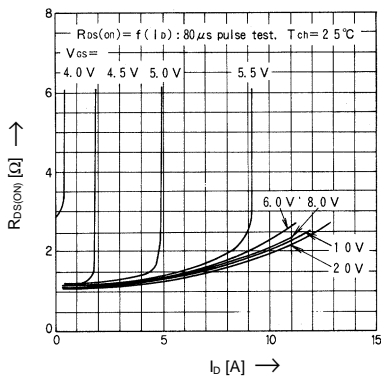

Typical Forward Transconductance vs. Id

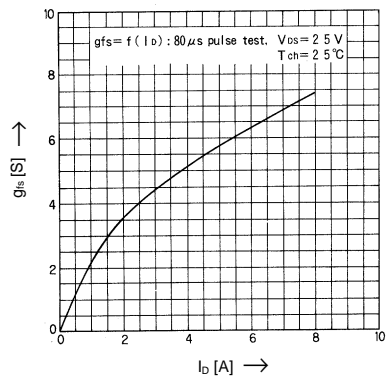

Gate Threshold Voltage vs. Tch

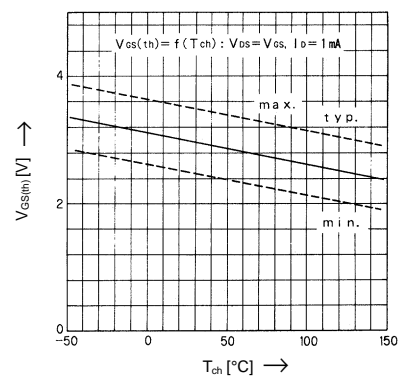

Typical Capacitance vs. Vds

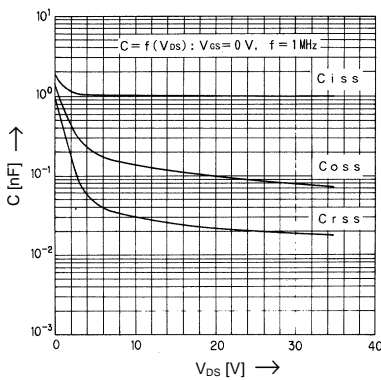

Typical Input Charge

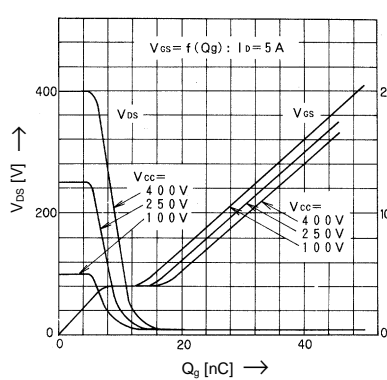

Forward Characteristics of Reverse Diode

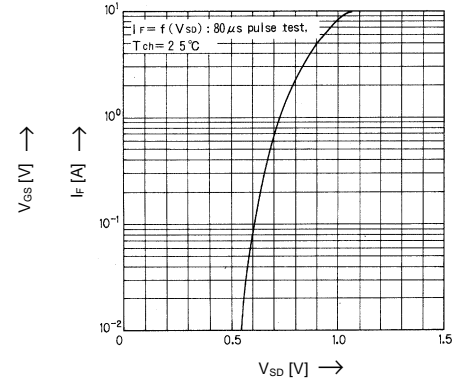

Allowable Power Dissipation vs. Tc

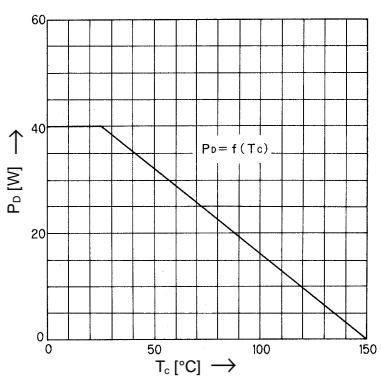

Safe operation area

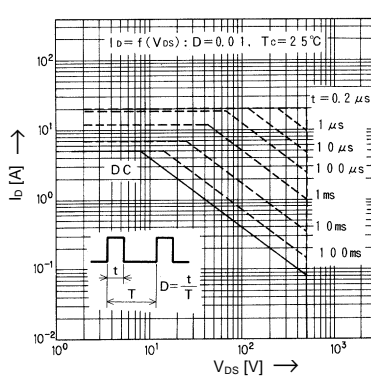

Zth(jc-0)

