

Notice: You cannot copy or search for text in this PDF file, because this PDF file is converted from the scanned image of printed materials.

P1 98.2

MOS FIELD EFFECT POWER TRANSISTOR 2SK2234

SWITCHING N-CHANNEL POWER MOS FET INDUSTRIAL USE

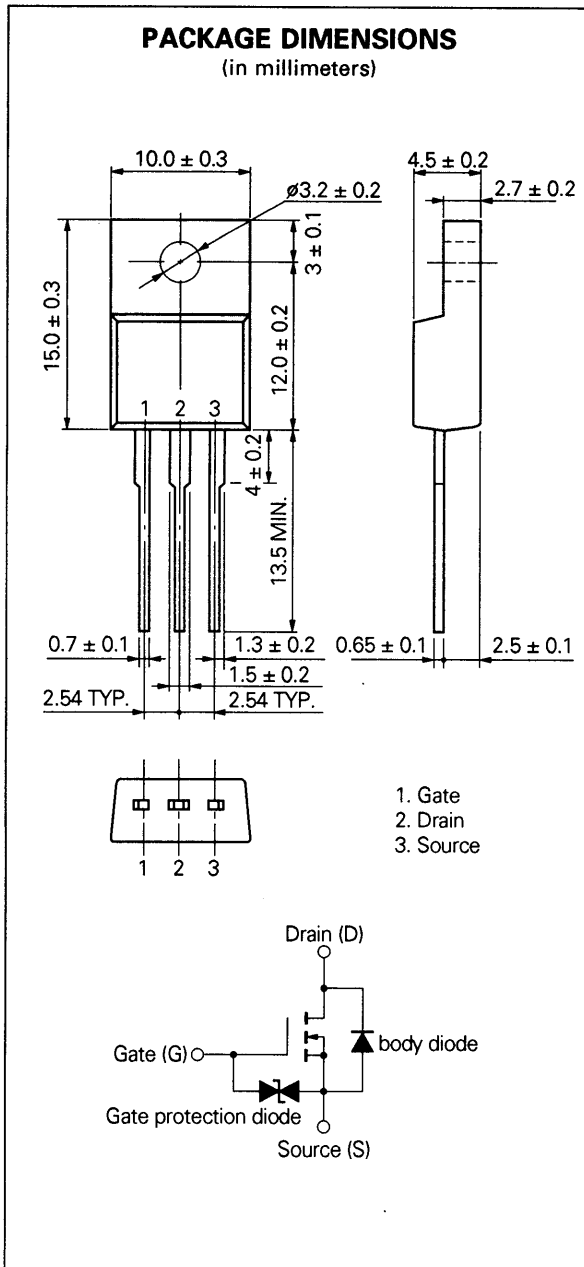

DESCRIPTION

The 2SK2234 is N-channel Power MOS Field Effect Transistor designed for high voltage switching applications.

FEATURES

- Low On-state Resistance
 $R_{DS(on)} = 0.6 \Omega$ MAX. ($V_{GS} = 10 V$, $I_D = 4.0 A$)
- Low C_{iss} $C_{iss} = 1\ 500$ pF TYP.
- Built-in G-S Gate Protection Diodes
- High Avalanche Capability Ratings

QUALITY GRADE

Standard

Please refer to "Quality grade on NEC Semiconductor Devices" (Document number IEI-1209) published by NEC Corporation to know the specification of quality grade on the devices and its recommended applications.

ABSOLUTE MAXIMUM RATINGS

Maximum Temperatures

Storage Temperature	-55 to +150	°C
Channel Temperature	150	°C MAX.

Maximum Power Dissipation

Total Power Dissipation ($T_c = 25$ °C)	40	W
Total Power Dissipation ($T_a = 25$ °C)	2.0	W

Maximum Voltages and Currents ($T_a = 25$ °C)

V_{DSS}	Drain to Source Voltage	500	V
V_{GSS}	Gate to Source Voltage	±30	V
$I_{D(DC)}$	Drain Current (DC)	±8.0	A
$I_{D(pulse)^*}$	Drain Current (pulse)	±32	A

Maximum Avalanche Capability Ratings**

I_{AS}	Single Avalanche Current	12	A
E_{AS}	Single Avalanche Energy	362	mJ

* $PW \leq 10 \mu s$, Duty Cycle $\leq 1\%$

** Starting $T_{ch} = 25$ °C, $R_G = 25 \Omega$, $V_{GS} = 20 V \rightarrow 0$

ELECTRICAL CHARACTERISTICS (T_a = 25 °C)

CHARACTERISTIC	SYMBOL	MIN.	TYP.	MAX.	UNIT	TEST CONDITIONS
Drain to Source On-state Resistance	R _{DS(on)}		0.5	0.6	Ω	V _{GS} = 10 V, I _D = 4 A
Gate to Source Cutoff Voltage	V _{GS(off)}	2.5		3.5	V	V _{DS} = 10 V, I _D = 1 mA
Forward Transfer Admittance	y _{fs}	3.0			S	V _{DS} = 10 V, I _D = 4 A
Drain Leakage Current	I _{DSS}			100	μA	V _{DS} = 500 V, V _{GS} = 0
Gate to Source Leakage Current	I _{GSS}			±10	μA	V _{GS} = ±20 V, V _{DS} = 0
Input Capacitance	C _{iss}		1 500		pF	V _{DS} = 10 V V _{GS} = 0 f = 1 MHz
Output Capacitance	C _{oss}		480		pF	
Reverse Transfer Capacitance	C _{res}		200		pF	
Turn-On Delay Time	t _{d(on)}		23		ns	V _{GS} = 10 V V _{DD} = 150 V I _D = 4 A, R _G = 10 Ω R _L = 37.5 Ω
Rise Time	t _r		23		ns	
Turn-Off Delay Time	t _{d(off)}		104		ns	
Fall Time	t _f		21		ns	
Total Gate Charge	Q _G		57		nC	V _{GS} = 10 V I _D = 8 A V _{DD} = 400 V
Gate to Source Charge	Q _{GS}		8.6		nC	
Gate to Drain Charge	Q _{GD}		3.4		nC	
Diode Forward Voltage	V _{F(S-D)}		1.0		V	I _F = 8 A, V _{GS} = 0
Reverse Recovery Time	t _{rr}		435		ns	I _F = 8 A di/dt = 50 A/μs
Reverse Recovery Charge	Q _{rr}		2.1		μC	

Test Circuit 1: Avalanche Capability

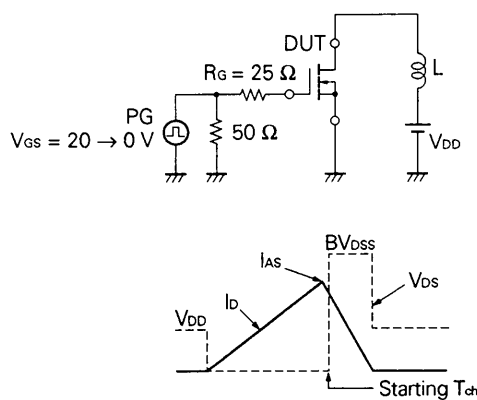

Test Circuit 2: Switching Time

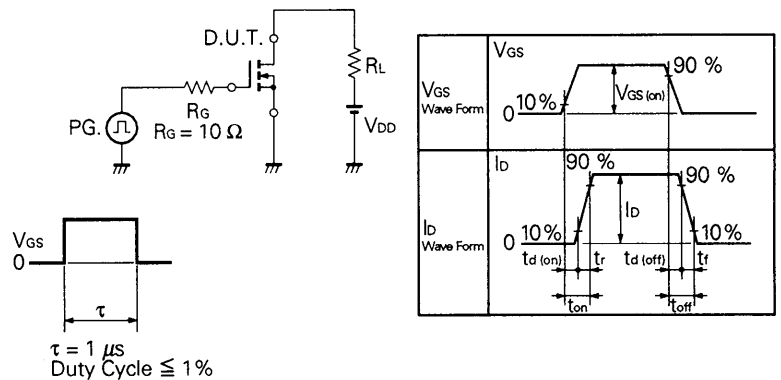

Test Circuit 3: Gate Charge

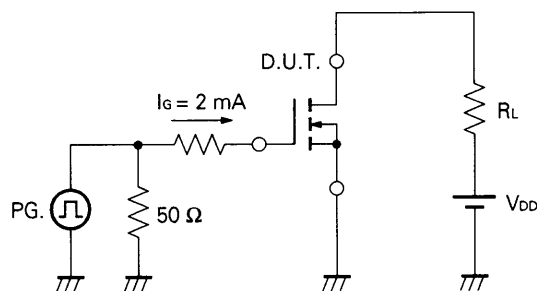

TYPICAL CHARACTERISTICS ($T_a = 25\text{ }^\circ\text{C}$)

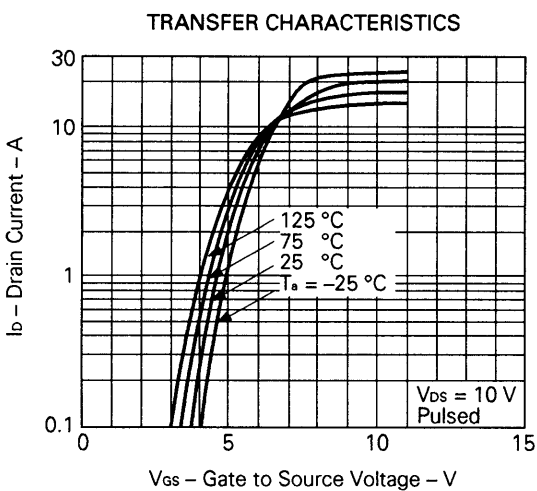
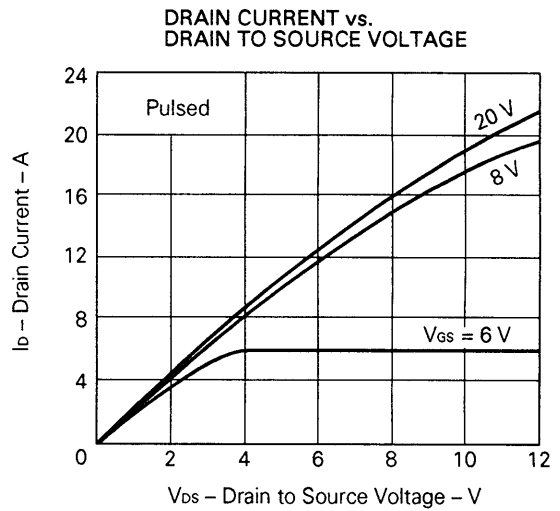
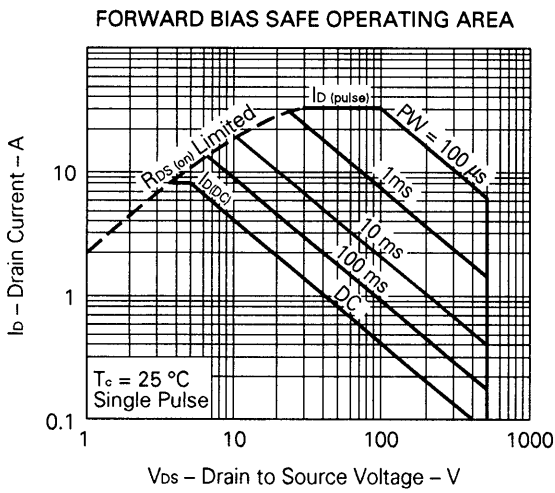
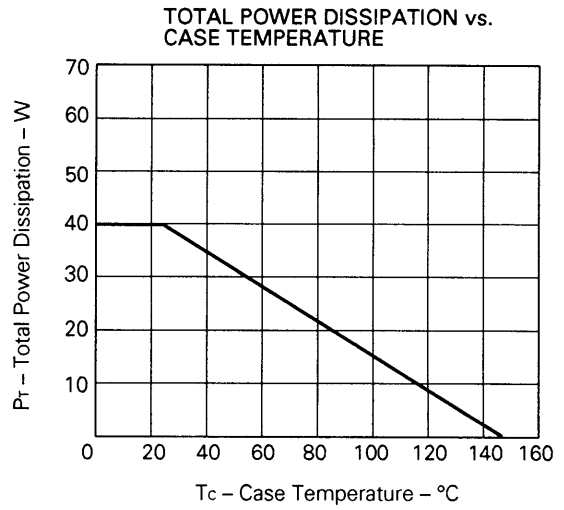
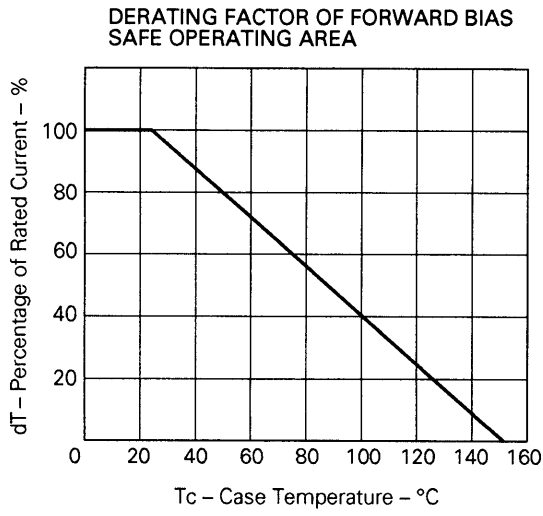

TRANSIENT THERMAL RESISTANCE vs. PULSE WIDTH

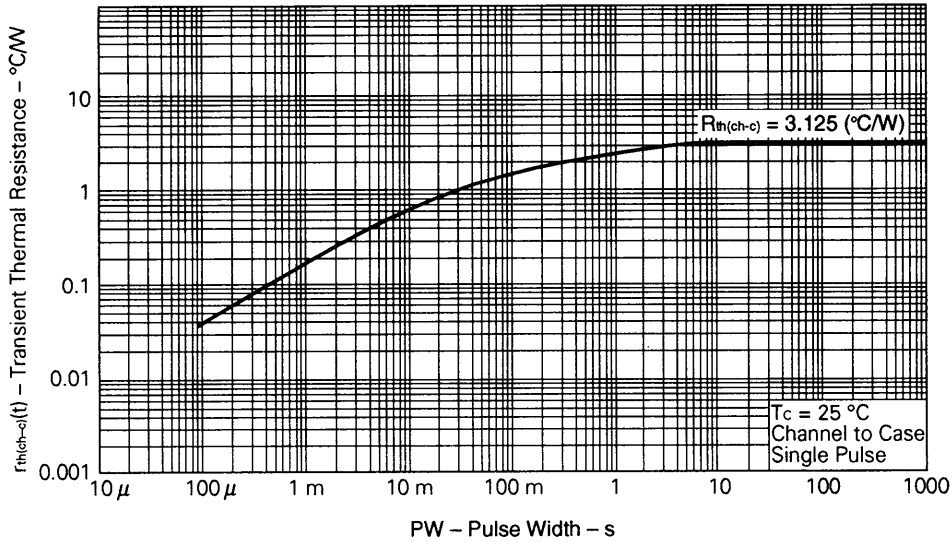

FORWARD TRANSFER ADMITTANCE vs. DRAIN CURRENT

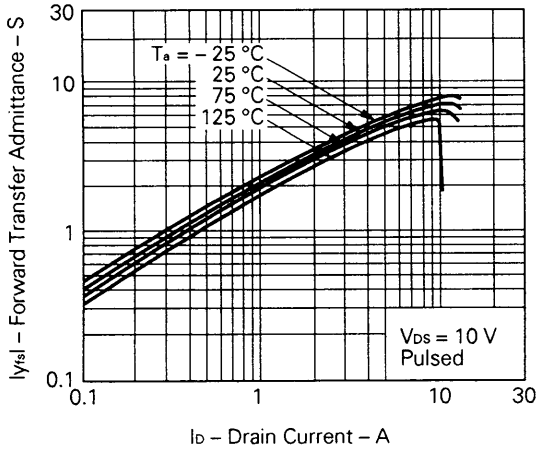

DRAIN TO SOURCE ON-STATE RESISTANCE vs. GATE TO SOURCE VOLTAGE

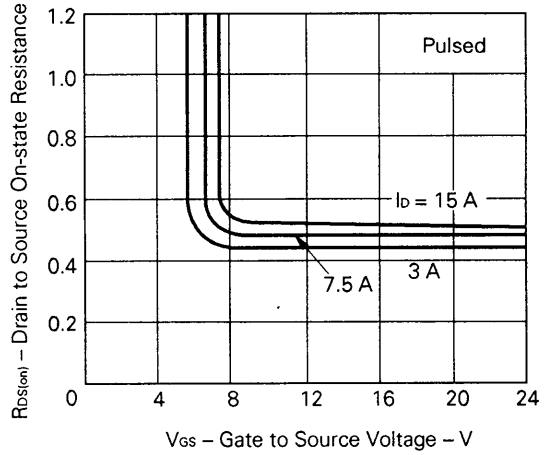

DRAIN TO SOURCE ON-STATE RESISTANCE vs. DRAIN CURRENT

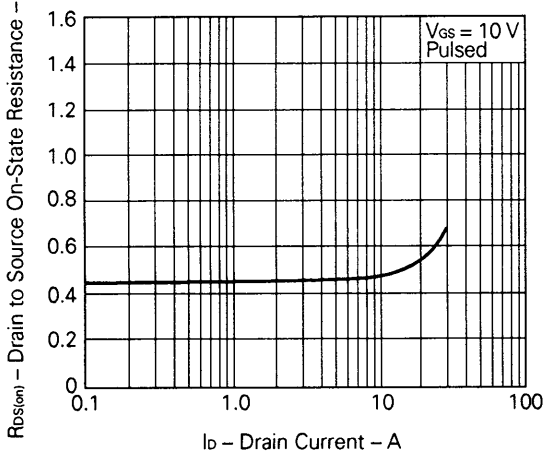

GATE TO SOURCE CUTOFF VOLTAGE vs. CHANNEL TEMPERATURE

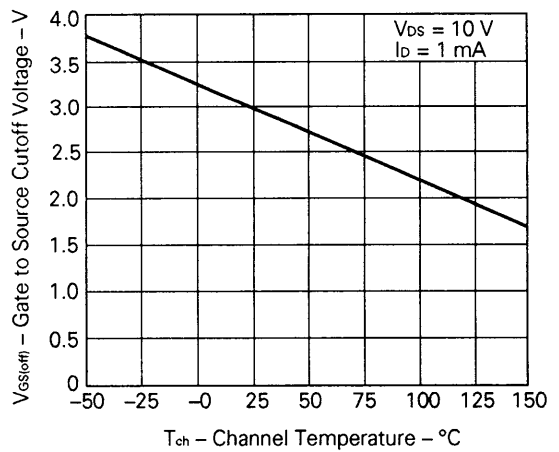

DRAIN TO SOURCE ON-STATE RESISTANCE vs. CHANNEL TEMPERATURE

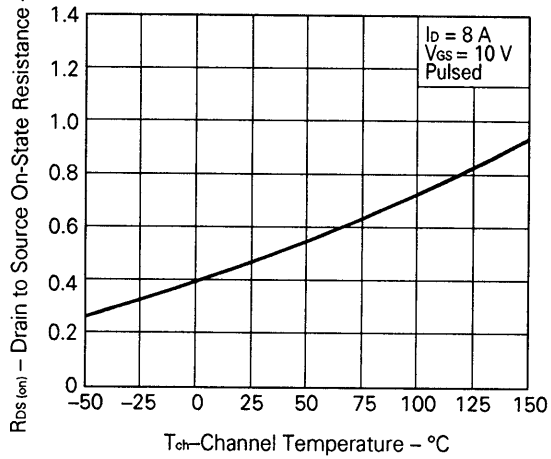

SOURCE TO DRAIN DIODE FORWARD VOLTAGE

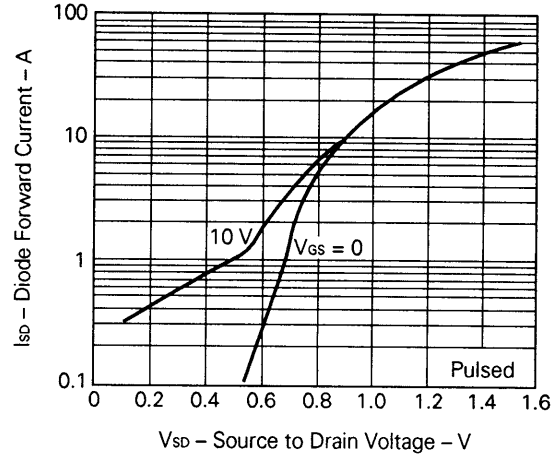

CAPACITANCE vs. DRAIN TO SOURCE VOLTAGE

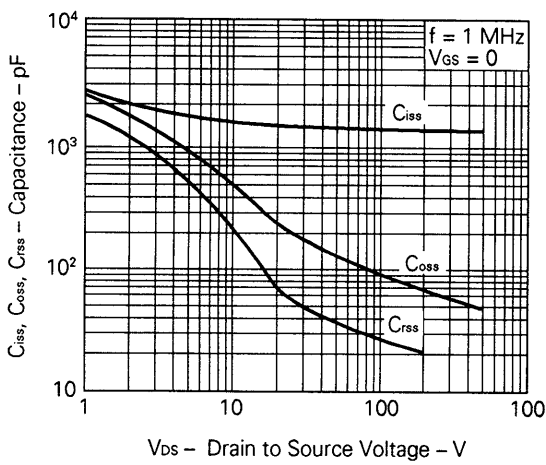

SWITCHING CHARACTERISTICS

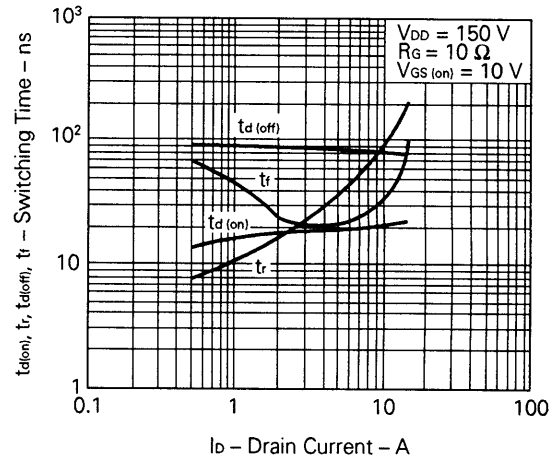

DYNAMIC INPUT CHARACTERISTICS

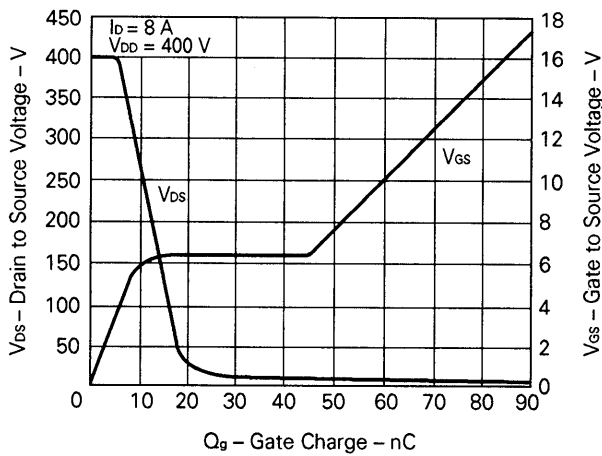

REVERSE RECOVERY TIME vs. DIODE FORWARD CURRENT

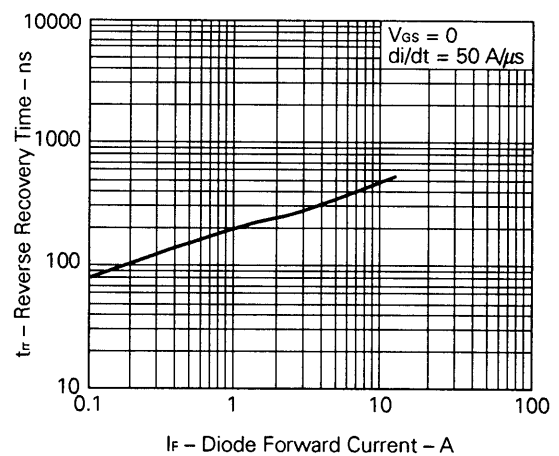

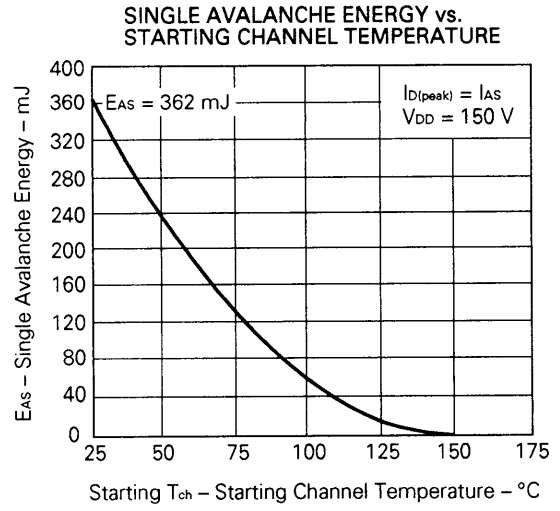
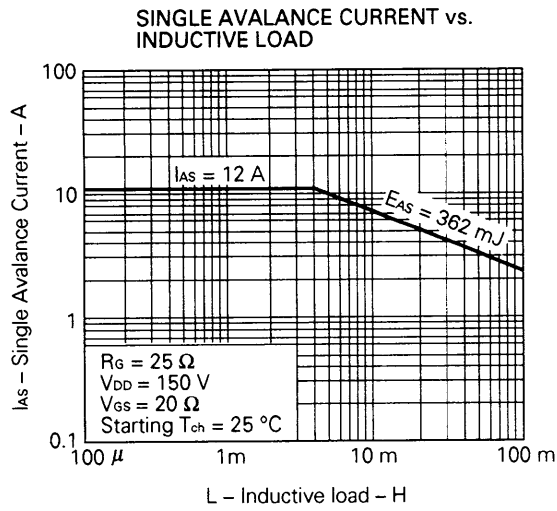

Reference

Application note name	No.
Safe operating area of Power MOS FET.	TEA-1034
Application circuit using Power MOS FET.	TEA-1035
Quality control of NEC semiconductors devices.	TEI-1202
Quality control guide of semiconductors devices.	MEI-1202
Assembly manual of semiconductors devices.	IEI-1207

[MEMO]

[MEMO]

No part of this document may be copied or reproduced in any form or by any means without the prior written consent of NEC Corporation. NEC Corporation assumes no responsibility for any errors which may appear in this document.

NEC Corporation does not assume any liability for infringement of patents, copyrights or other intellectual property rights of third parties by or arising from use of a device described herein or any other liability arising from use of such device. No license, either express, implied or otherwise, is granted under any patents, copyrights or other intellectual property rights of NEC Corporation or others.

The devices listed in this document are not suitable for use in aerospace equipment, submarine cables, nuclear reactor control systems and life support systems. If customers intend to use NEC devices for above applications or they intend to use "Standard" quality grade NEC devices for applications not intended by NEC, please contact our sales people in advance.

Application examples recommended by NEC Corporation.

Standard: Computer, Office equipment, Communication equipment, Test and Measurement equipment, Machine tools, Industrial robots, Audio and Visual equipment, Other consumer products, etc.

Special: Automotive and Transportation equipment, Traffic control systems, Antidisaster systems, Anticrime systems, etc.