

Silicon N-Channel MOSFET

Features

- 11A,500V, $R_{DS(on)}$ (Max0.55 Ω)@ $V_{GS}=10V$
- Ultra-low Gate charge(Typical 43nC)
- Fast Switching Capability
- 100%Avalanche Tested
- Maximum Junction Temperature Range(150 $^{\circ}C$)

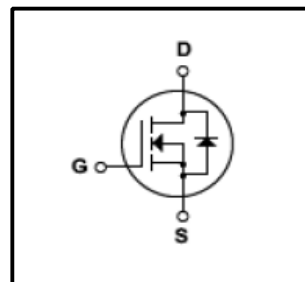

General Description

This Power MOSFET is produced using Winsemi's advanced planar stripe, VDMOS technology. This latest technology has been especially designed to minimize on-state resistance, have a high rugged avalanche characteristics. This device is specially well suited for AC-DC switching power supplies, DC-DC power Converters high voltage H-bridge motor drive PWM

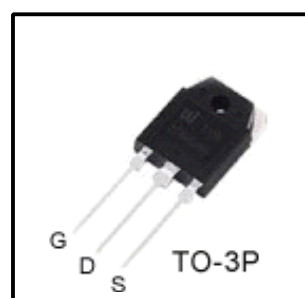

Absolute Maximum Ratings

Symbol	Parameter	Value	Units
V_{DSS}	Drain Source Voltage	500	V
I_D	Continuous Drain Current(@ $T_c=25^{\circ}C$)	11	A
	Continuous Drain Current(@ $T_c=100^{\circ}C$)	7	A
I_{DM}	Drain Current Pulsed (Note1)	44	A
V_{GS}	Gate to Source Voltage	± 30	V
E_{AS}	Single Pulsed Avalanche Energy (Note2)	670	mJ
E_{AR}	Repetitive Avalanche Energy (Note1)	19.5	mJ
dv/dt	Peak Diode Recovery dv /dt (Note3)	4.5	V/ ns
P_D	Total Power Dissipation(@ $T_c=25^{\circ}C$)	195	W
T_J, T_{stg}	Junction and Storage Temperature	-55~150	$^{\circ}C$
T_L	Channel Temperature	300	$^{\circ}C$

Thermal Characteristics

Symbol	Parameter	Value			Units
		Min	Typ	Max	
R_{QJC}	Thermal Resistance , Junction -to -Case	-	-	0.64	$^{\circ}C/W$
R_{QJA}	Thermal Resistance , Junction-to -Ambient	-	-	62.5	$^{\circ}C/W$

Electrical Characteristics(Tc=25°C)

Characteristics	Symbol	Test Condition	Min	Type	Max	Unit	
Gate leakage current	I_{GSS}	$V_{GS}=\pm 30V, V_{DS}=0V$	-	-	± 100	nA	
Gate-source breakdown voltage	$V_{(BR)GSS}$	$I_G=\pm 10 \mu A, V_{DS}=0V$	± 30	-	-	V	
Drain cut-off current	I_{DSS}	$V_{DS}=500V, V_{GS}=0V$	-	-	10	μA	
		$V_{DS}=400V, T_c=125^\circ C$	-	-	100		
Drain-source breakdown voltage	$V_{(BR)DSS}$	$I_D=10 mA, V_{GS}=0V$	500	-	-	V	
Gate threshold voltage	$V_{GS(th)}$	$V_{DS}=V_{GS}, I_D=250\mu A$	2	-	4	V	
Drain-source ON resistance	$R_{DS(ON)}$	$V_{GS}=10V, I_D=5.5A$	-	0.48	0.55	Ω	
Forward Transconductance	gfs	$V_{DS}=40V, I_D=5.5A$	-	15	-	S	
Input capacitance	C_{iss}	$V_{DS}=25V,$ $V_{GS}=0V,$ $f=1MHz$	-	1515	2055	pF	
Reverse transfer capacitance	C_{rss}		-	25	30		
Output capacitance	C_{oss}		-	185	235		
Switching time	Rise time	t_r	$V_{DD}=250V,$ $I_D=11A$ $R_G=25\Omega$ (Note4,5)	-	70	150	ns
	Turn-on time	t_{on}		-	24	57	
	Fall time	t_f		-	75	160	
	Turn-off time	t_{off}		-	120	250	
Total gate charge(gate-source plus gate-drain)	Q_g	$V_{DS}=400V,$ $V_{GS}=10V,$ $I_D=11A$ (Note4,5)	-	43	55	nC	
Gate-source charge	Q_{gs}		-	8	-		
Gate-drain("miller") Charge	Q_{gd}		-	19	-		

Source-Drain Ratings and Characteristics(Ta=25°C)

Characteristics	Symbol	Test Condition	Min	Type	Max	Unit
Continuous drain reverse current	I_{DR}	-	-	-	11	A
Pulse drain reverse current	I_{DRP}	-	-	-	44	A
Forward voltage(diode)	V_{DSF}	$I_{DR}=11A, V_{GS}=0V$	-	-	1.4	V
Reverse recovery time	t_{rr}	$I_{DR}=11A, V_{GS}=0V,$ $di_{DR} / dt = 100 A / \mu s$	-	90	-	ns
Reverse recovery charge	Q_{rr}		-	1.5	-	μC

Note 1.Repeativity rating :pulse width limited by junction temperature

2.L=10mH $I_{AS}=11A, V_{DD}=50V, R_G=25\Omega, Starting T_J=25^\circ C$

3. $I_{SD}\leq 11A, di/dt\leq 200A/\mu s, V_{DD}<BV_{DSS}, STARTING T_J=25^\circ C$

4.Pulse Test:Pulse Width $\leq 300\mu s, Duty Cycle\leq 2\%$

5. Essentially independent of operating temperature.

This transistor is an electrostatic sensitive device

Please handle with caution

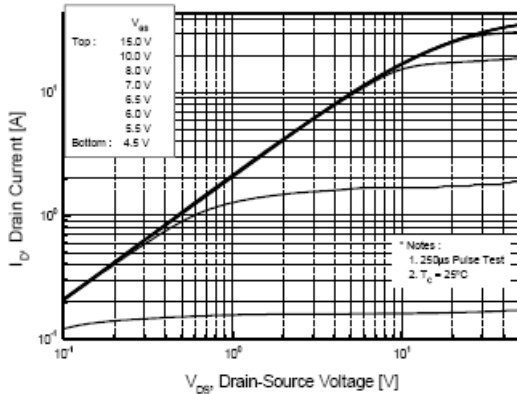

Fig.1 On State Characteristics

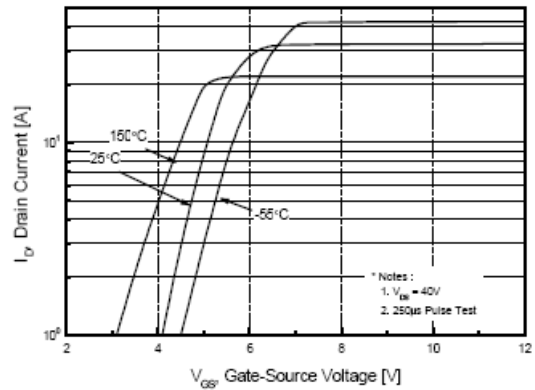

Fig.2 Transfer Current Characteristics

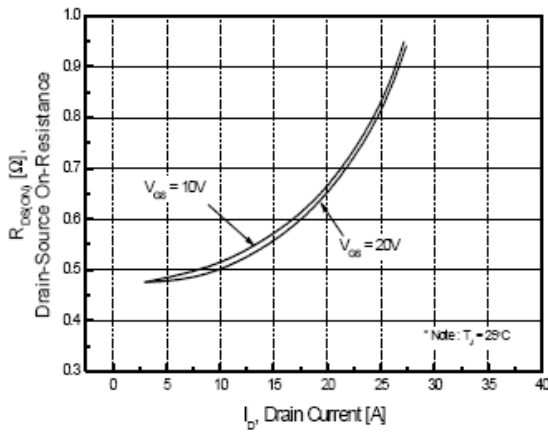

Fig.3 On-Resistance Variation vs Drain Current

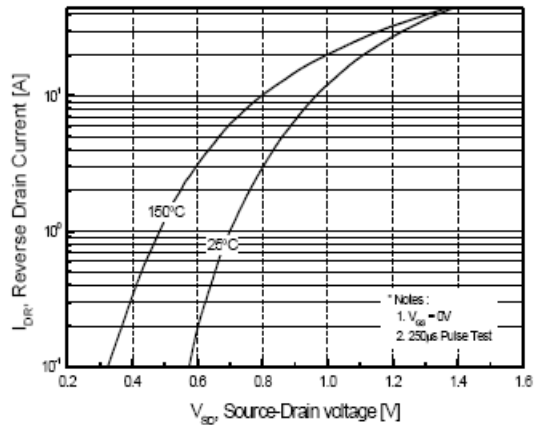

Fig.4 Body Diode Forward Voltage Variation with Source Current and Temperature

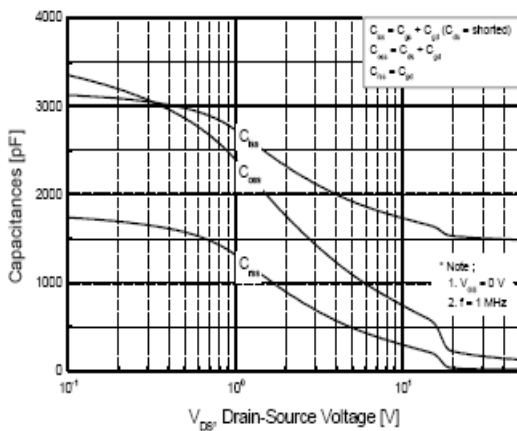

Fig.5 Capacitance Characteristics

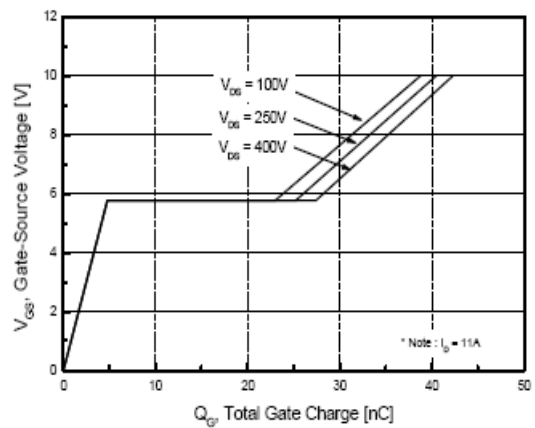

Fig.6 Gate Charge Characteristics

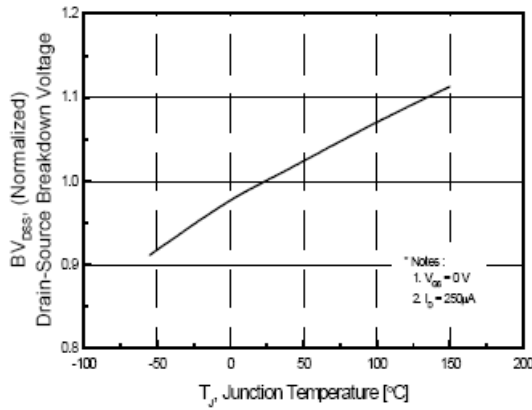

Fig.7 Breakdown Voltage Variation

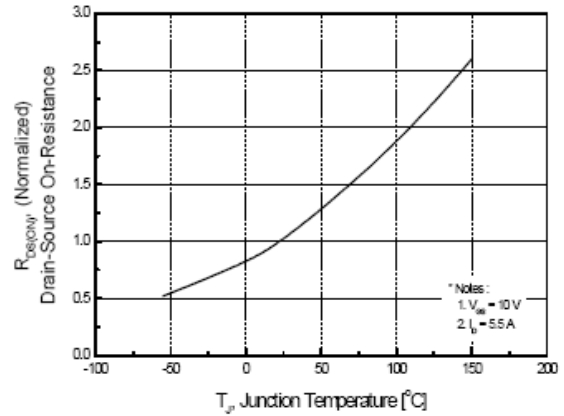

Fig.8 On-Resistance Variation vs. Temperature

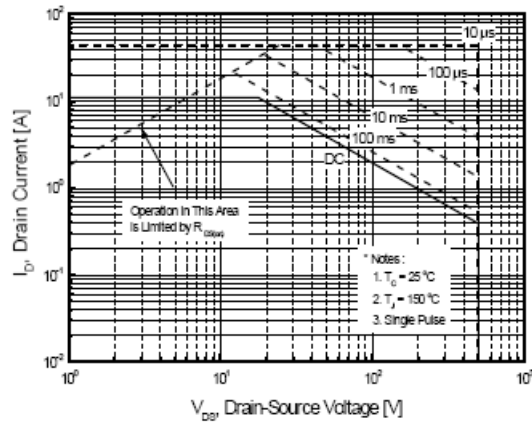

Fig.9 Maximum Safe Operation Area

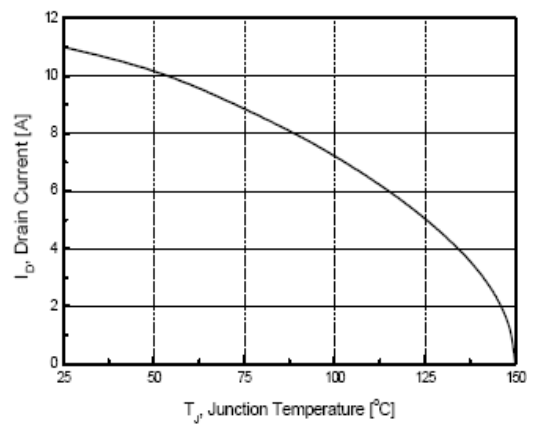

Fig.10 Maximum Drain Current vs Case Temperature

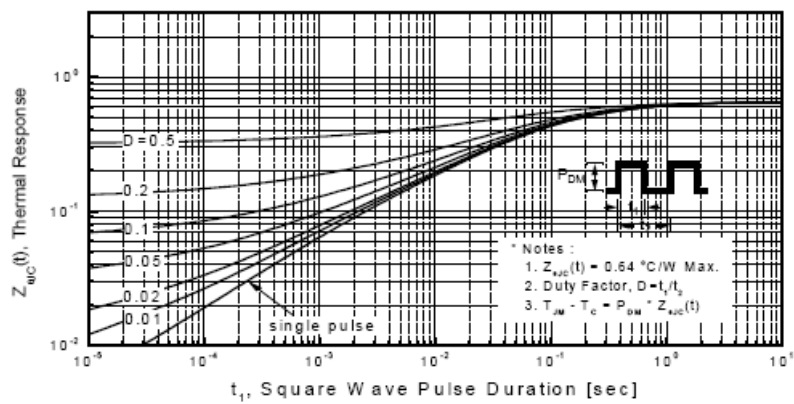

Fig.11 Transient Thermal Response Curve

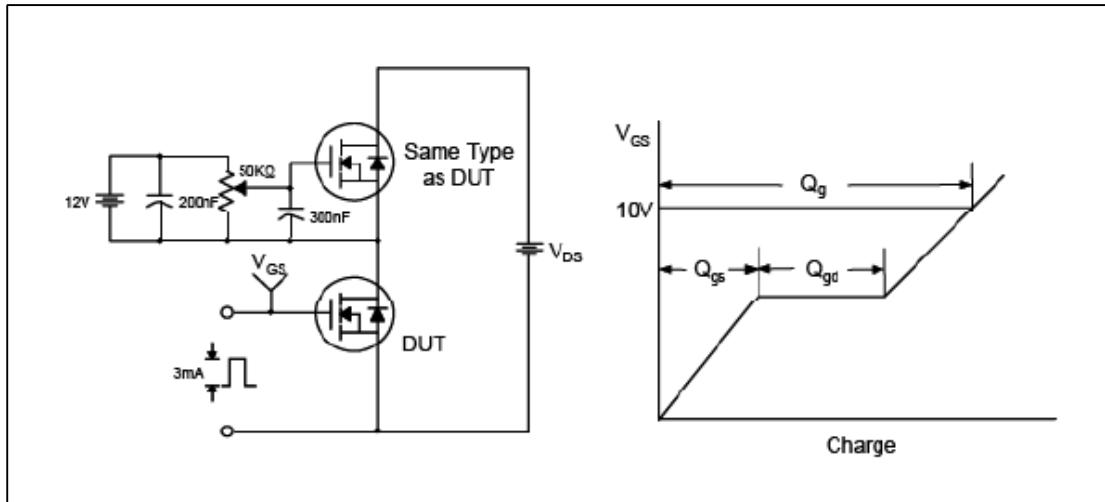

Fig.12 Gate Test Circuit & Waveform

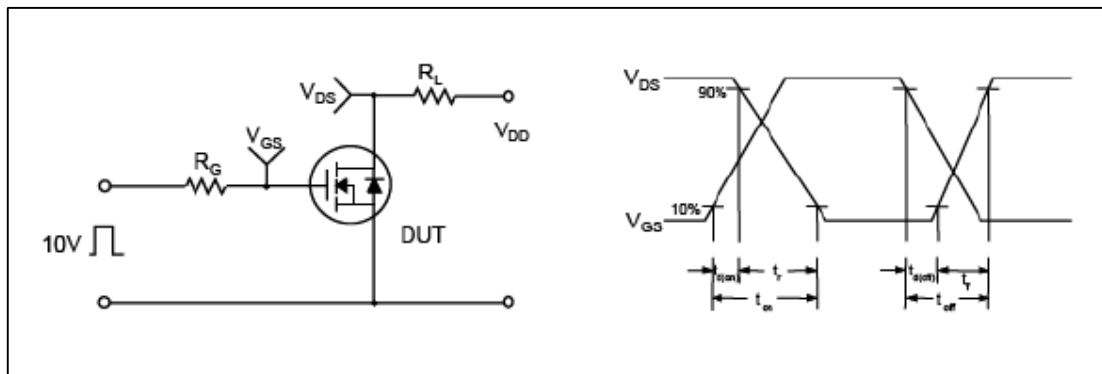

Fig.13 Resistive Switching Test Circuit & Waveform

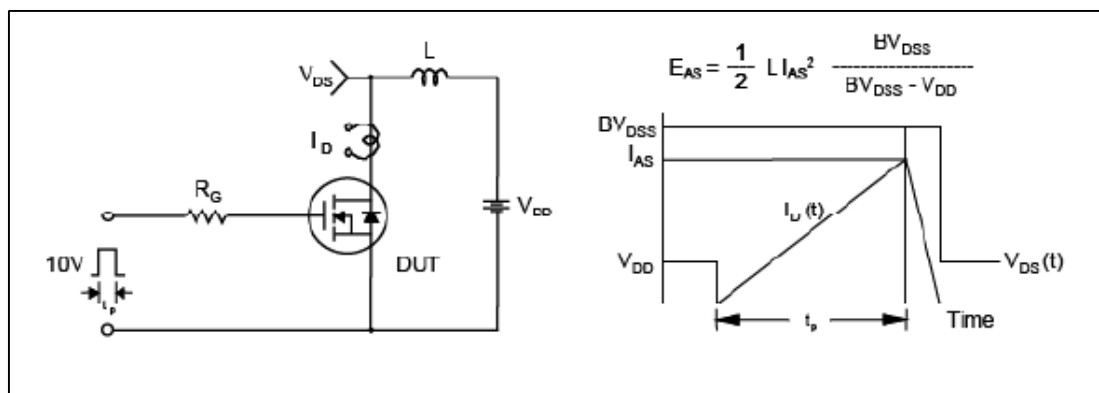

Fig.14 Unclamped Inductive Switching Test Circuit & Waveform

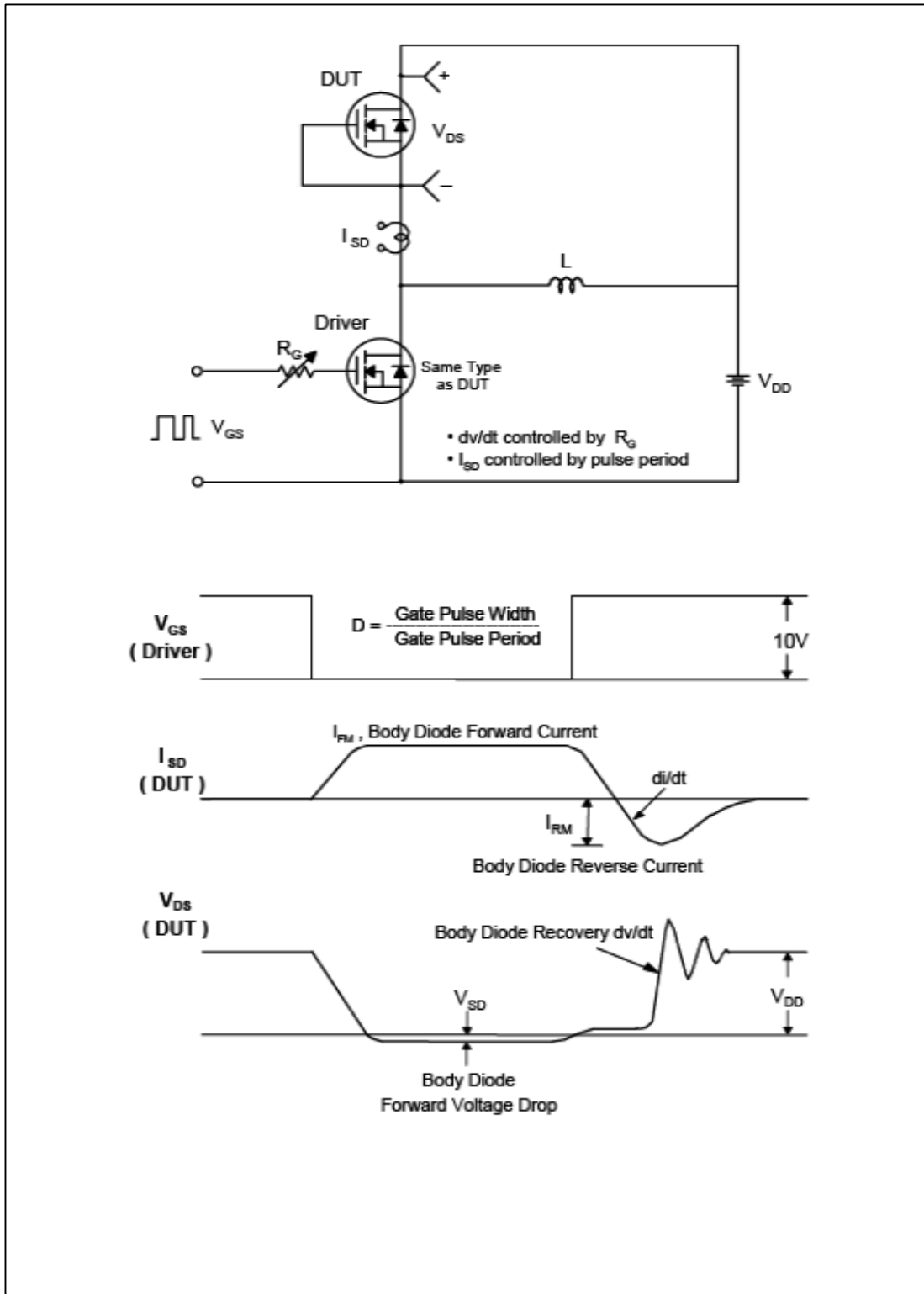

Fig.15 Peak Diode Recovery dv/dt Test Circuit & Waveform

TO-3P Package Dimension

