

> Features

- High Speed Switching
- Low On-Resistance
- No Secondary Breakdown
- Low Driving Power
- High Voltage
- $V_{GS} = \pm 30V$ Guarantee
- Repetitive Avalanche Rated

> Applications

- Switching Regulators
- UPS
- DC-DC converters
- General Purpose Power Amplifier

> Outline Drawing

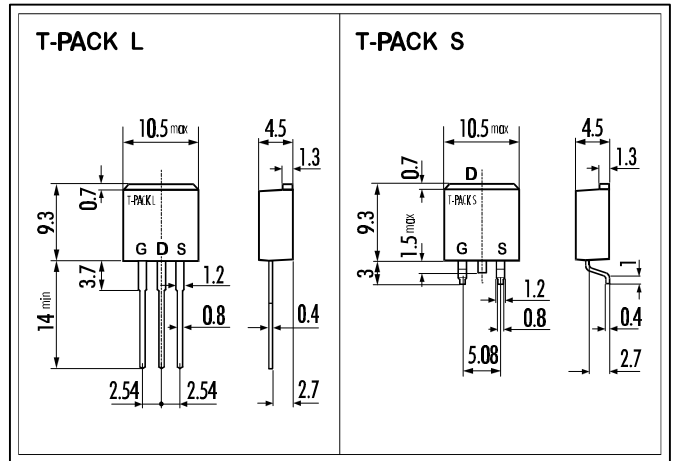

> Maximum Ratings and Characteristics

- Absolute Maximum Ratings ($T_C=25^\circ C$), unless otherwise specified

Item	Symbol	Rating	Unit
Drain-Source-Voltage	V_{DS}	450	V
Continuous Drain Current	I_D	±8	A
Pulsed Drain Current	$I_{D(puls)}$	±32	A
Gate-Source-Voltage	V_{GS}	±35	V
Repetitive or non-repetitive	I_{AV}	8	A
Max. Avalanche Energy	E_{AV}	215.9	mJ
Max. Power Dissipation	P_D	50	W
Operating and Storage Temperature Range	T_{ch}	150	$^\circ C$
	T_{stg}	-55 ~ +150	$^\circ C$

$L=6.19mH, V_{CC}=45V$

> Equivalent Circuit

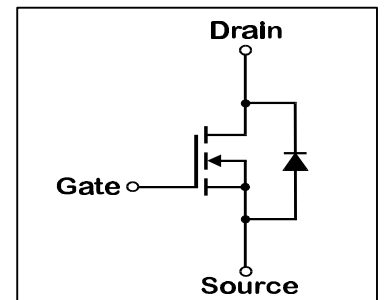

- Electrical Characteristics ($T_C=25^\circ C$), unless otherwise specified

Item	Symbol	Test conditions	Min.	Typ.	Max.	Unit
Drain-Source Breakdown-Voltage	BV_{DSS}	$I_D=1mA, V_{GS}=0V$	450			V
Gate Threshold Voltage	$V_{GS(th)}$	$I_D=1mA, V_{DS}=V_{GS}$	3,5	4,0	4,5	V
Zero Gate Voltage Drain Current	I_{DSS}	$V_{DS}=450V, T_{ch}=25^\circ C$		10	500	μA
		$V_{GS}=0V, T_{ch}=125^\circ C$		0,2	1,0	mA
Gate Source Leakage Current	I_{GSS}	$V_{GS}=\pm 35V, V_{DS}=0V$		10	100	nA
Drain Source On-State Resistance	$R_{DS(on)}$	$I_D=4A, V_{GS}=10V$		1,0	1,2	Ω
Forward Transconductance	g_{fs}	$I_D=4A, V_{DS}=25V$	2	4		S
Input Capacitance	C_{iss}	$V_{DS}=25V, V_{GS}=0V$		540	810	pF
Output Capacitance	C_{oss}	$f=1MHz$		100	150	pF
Reverse Transfer Capacitance	C_{rss}	$V_{CC}=300V, I_D=8A, V_{GS}=10V, R_{GS}=10\Omega$		45	70	pF
Turn-On-Time $t_{on} (t_{on}=t_{d(on)}+t_r)$	$t_{d(on)}$			13	20	ns
	t_r			40	60	ns
Turn-Off-Time $t_{off} (t_{off}=t_{d(off)}+t_f)$	$t_{d(off)}$			45	70	ns
	t_f			25	40	ns
Avalanche Capability	I_{AV}	$L = 6,19mH, T_{ch}=25^\circ C$	8			A
Diode Forward On-Voltage	V_{SD}	$I_F=2xI_{DR}, V_{GS}=0V, T_{ch}=25^\circ C$		1,10	1,65	V
Reverse Recovery Time	t_{rr}	$I_F=I_{DR}, V_{GS}=0V$		450	120	ns
Reverse Recovery Charge	Q_{rr}	$-di_F/dt=100A/\mu s, T_{ch}=25^\circ C$		3,7		μC

- Thermal Characteristics

Item	Symbol	Test conditions	Min.	Typ.	Max.	Unit
Thermal Resistance	$R_{th(ch-c)}$	channel to case			2,5	$^\circ C/W$
	$R_{th(ch-a)}$	channel to air			125,0	$^\circ C/W$

N-channel MOS-FET			
450V	1,2Ω	±8A	50W

2SK2870-01L,S

FAP-IIS Series



> Characteristics

Typical Output Characteristics

$I_D = f(V_{DS})$; 80μs pulse test; $T_{ch} = 25^\circ\text{C}$

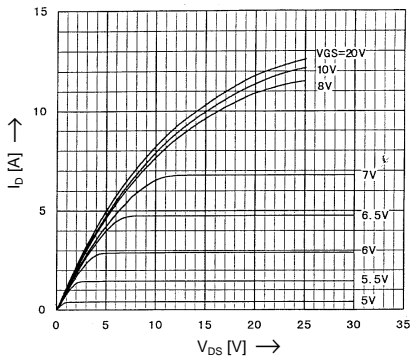

Drain-Source-On-State Resistance vs. T_{ch}

$R_{DS(on)} = f(T_{ch})$; $I_D = 4\text{A}$; $V_{GS} = 10\text{V}$

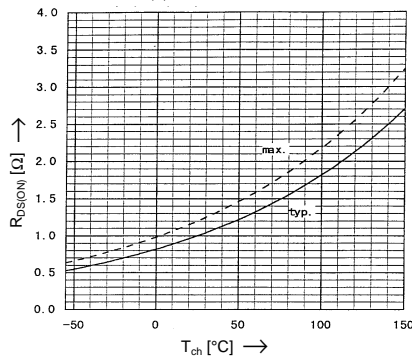

Typical Transfer Characteristics

$I_D = f(V_{GS})$; 80μs pulse test; $V_{DS} = 25\text{V}$; $T_{ch} = 25^\circ\text{C}$

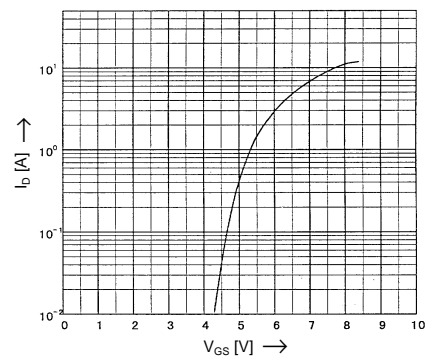

Typical Drain-Source-On-State-Resistance vs. I_D

$R_{DS(on)} = f(I_D)$; 80μs pulse test; $T_{ch} = 25^\circ\text{C}$

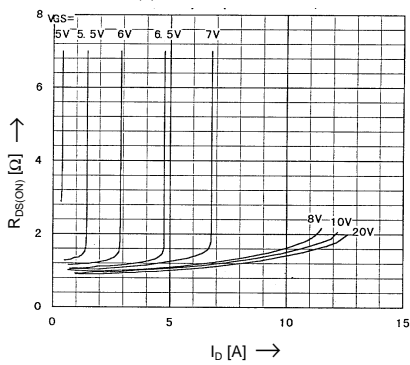

Typical Forward Transconductance vs. I_D

$g_{fs} = f(I_D)$; 80μs pulse test; $V_{DS} = 25\text{V}$; $T_{ch} = 25^\circ\text{C}$

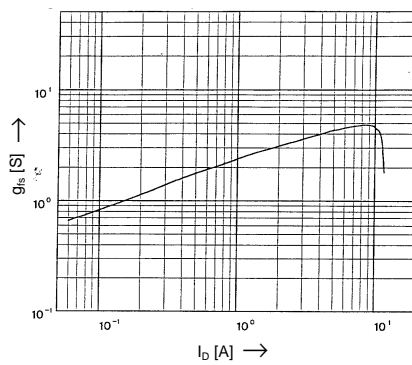

Gate Threshold Voltage vs. T_{ch}

$V_{GS(th)} = f(T_{ch})$; $I_D = 1\text{mA}$; $V_{DS} = V_{GS}$

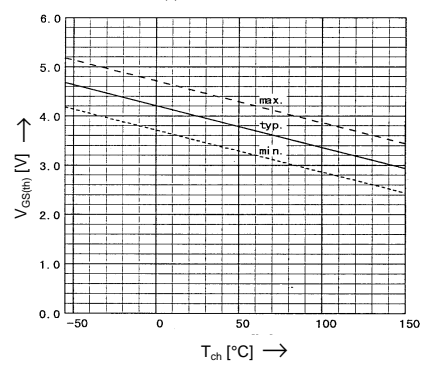

Typical Capacitances vs. V_{DS}

$C = f(V_{DS})$; $V_{GS} = 0\text{V}$; $f = 1\text{MHz}$

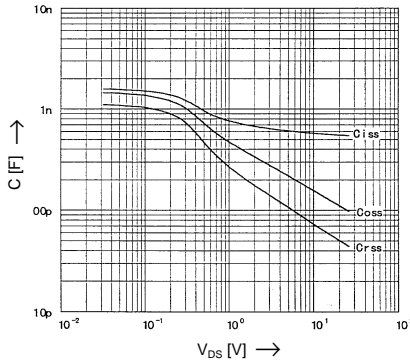

Typical Gate Charge Characteristic

$V_{GS} = f(Q_g)$; $I_D = 8\text{A}$; $T_{ch} = 25^\circ\text{C}$

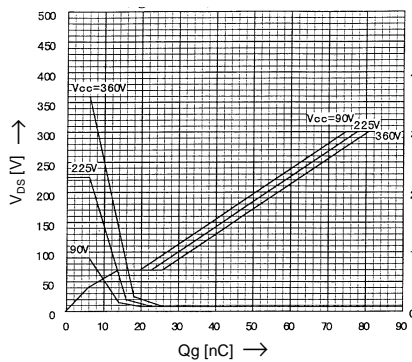

Forward Characteristics of Reverse Diode

$I_F = f(V_{SD})$; 80μs pulse test; $V_{GS} = 0\text{V}$

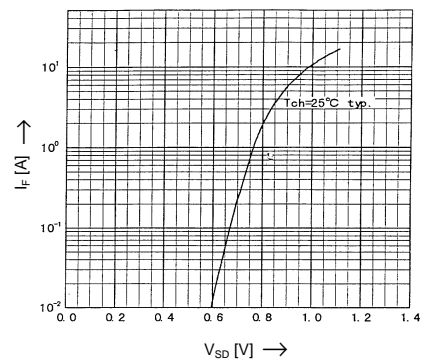

Avalanche Energy Derating

$E_{as} = f(\text{starting } T_{ch})$; $V_{CC} = 45\text{V}$; $I_{AV} = 8\text{A}$

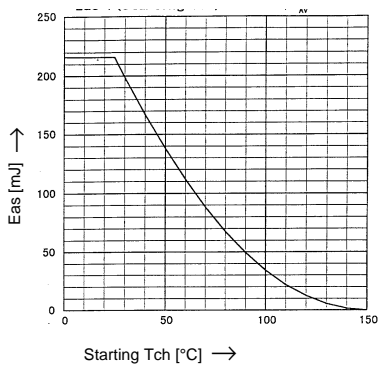

Safe operation area

$I_D = f(V_{DS})$; $D = 0.01$; $T_{ch} = 25^\circ\text{C}$

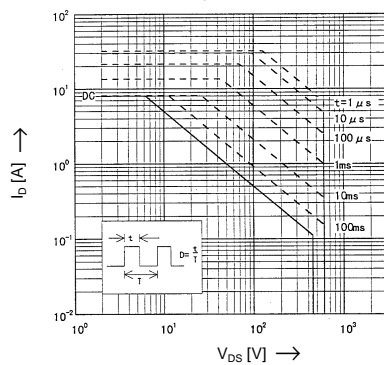

$Z_{th(ch-c)}$ [K/W] ↑

Transient thermal impedance

$Z_{th(ch-c)} = f(t)$ parameter: $D = t/T$

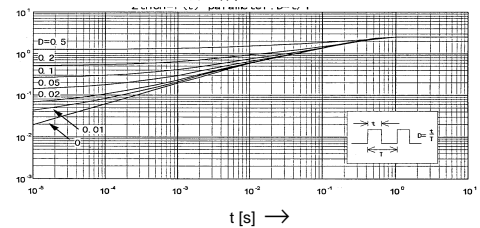

N-channel MOS-FET			
450V	1,2Ω	±8A	50W

2SK2870-01L,S

FAP-IIS Series



> Characteristics

