

## N-CHANNEL SILICON POWER MOSFET

## FAP-IIIB SERIES

### Features

- High speed switching
- Low on-resistance
- No secondary breakdown
- Low driving power
- High voltage
- Avalanche-proof

### Applications

- Switching regulators
- DC-DC converters
- General purpose power amplifier

### Outline Drawings

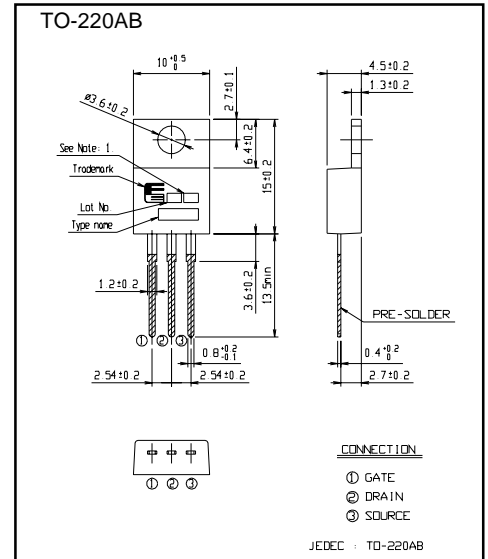

### Maximum ratings and characteristics

#### Absolute maximum ratings (Tc=25°C unless otherwise specified)

Item	Symbol	Rating	Unit	Remarks
Drain-source voltage	V <sub>DS</sub>	60	V	
Continuous drain current	I <sub>D</sub>	±50	A	
Pulsed drain current	I <sub>D</sub> [puls]	±200	A	
Gate-source peak voltage	V <sub>GS</sub>	±20	V	
Maximum avalanche energy	E <sub>AV</sub>	867	mJ	*1
Maximum power dissipation	P <sub>D</sub>	80	W	
Operating and storage temperature range	T <sub>ch</sub>	+150	°C	
	T <sub>stg</sub>	-55 to +150	°C	

\*1 L=0.463mH, V<sub>CC</sub>=24V

### Equivalent circuit schematic

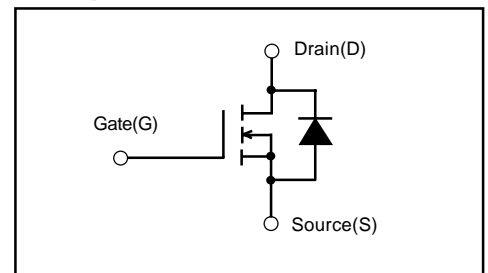

#### Electrical characteristics (Tc =25°C unless otherwise specified)

Item	Symbol	Test Conditions	Min.	Typ.	Max.	Units	
Drain-source breakdown voltage	V <sub>(BR)DSS</sub>	I <sub>D</sub> =1mA V <sub>GS</sub> =0V	60			V	
Gate threshold voltage	V <sub>GS(th)</sub>	I <sub>D</sub> =1mA V <sub>DS</sub> =V <sub>GS</sub>	1.0	1.5	2.0	V	
Zero gate voltage drain current	I <sub>DSS</sub>	V <sub>DS</sub> =60V V <sub>GS</sub> =0V	T <sub>ch</sub> =25°C		10	500	μA
			T <sub>ch</sub> =125°C		0.2	1.0	mA
Gate-source leakage current	I <sub>GSS</sub>	V <sub>GS</sub> =±20V V <sub>DS</sub> =0V		10	100	nA	
Drain-source on-state resistance	R <sub>DS(on)</sub>	I <sub>D</sub> =40A V <sub>GS</sub> =10V	V <sub>GS</sub> =4V		12	17	mΩ
			V <sub>GS</sub> =10V		7.5	10	mΩ
Forward transconductance	g <sub>fs</sub>	I <sub>D</sub> =40A V <sub>DS</sub> =25V	25	55		S	
Input capacitance	C <sub>iss</sub>	V <sub>DS</sub> =25V		3500	5250	pF	
Output capacitance	C <sub>oss</sub>	V <sub>GS</sub> =0V		1250	1870		
Reverse transfer capacitance	C <sub>rss</sub>	f=1MHz		360	540		
Turn-on time	t <sub>d(on)</sub>	V <sub>CC</sub> =30V R <sub>G</sub> =10 Ω		15	23	ns	
	t <sub>r</sub>	I <sub>D</sub> =75A		75	120		
Turn-off time	t <sub>d(off)</sub>	V <sub>GS</sub> =10V		190	285		
	t <sub>f</sub>			110	165		
Avalanche capability	I <sub>AV</sub>	L=100μH T <sub>ch</sub> =25°C	50			A	
Diode forward on-voltage	V <sub>SD</sub>	I <sub>F</sub> =160A V <sub>GS</sub> =0V T <sub>ch</sub> =25°C		1.15	1.65	V	
Reverse recovery time	t <sub>rr</sub>	I <sub>F</sub> =80A		75	120	ns	
Reverse recovery charge	Q <sub>rr</sub>	-di/dt=100A/μs T <sub>ch</sub> =25°C		0.17		μC	

### Thermal characteristics

Item	Symbol	Min.	Typ.	Max.	Units
Thermal resistance	R <sub>th(ch-c)</sub>			1.56	°C/W
	R <sub>th(ch-a)</sub>			75.0	°C/W

Characteristics

Power Dissipation  
 $PD=f(T_c)$

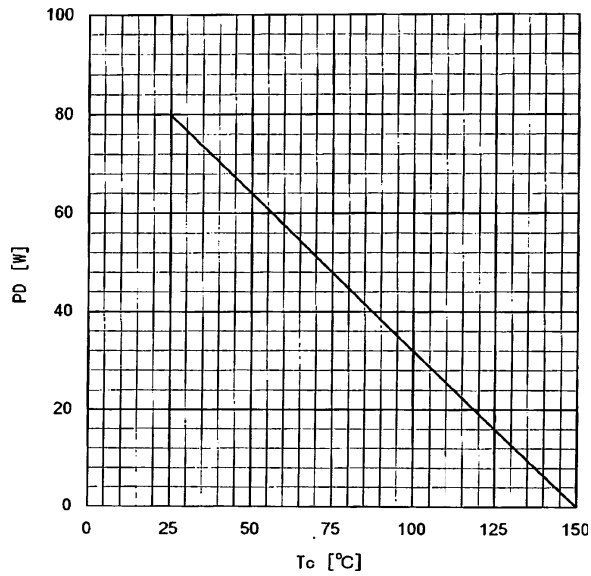

Safe operating area  
 $ID=f(V_{DS}) : D=0.01, T_c=25^\circ C$

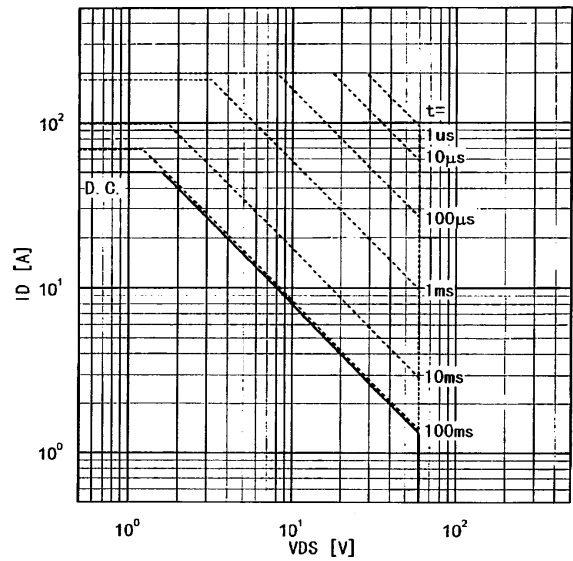

Typical Output Characteristics  
 $ID=f(V_{DS}) : 80\mu s$  pulse test,  $T_{ch}=25^\circ C$

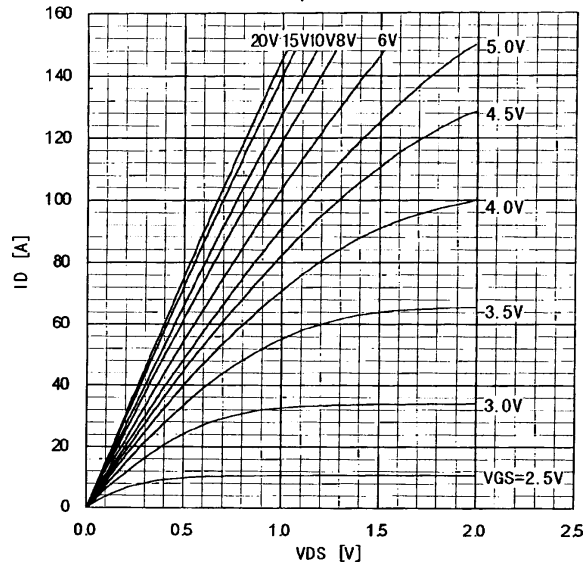

Typical Transfer Characteristic  
 $ID=f(V_{GS}) : 80\mu s$  pulse test,  $V_{DS}=25V, T_{ch}=25^\circ C$

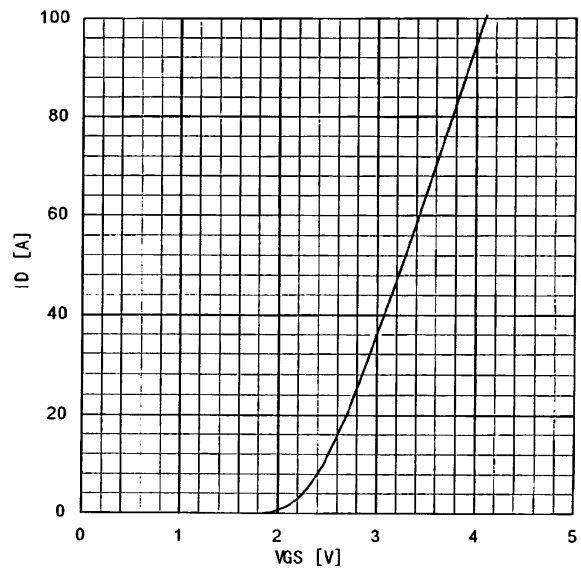

Typical Transconductance  
 $g_{fs}=f(ID) : 80\mu s$  pulse test,  $V_{DS}=25V, T_{ch}=25^\circ C$

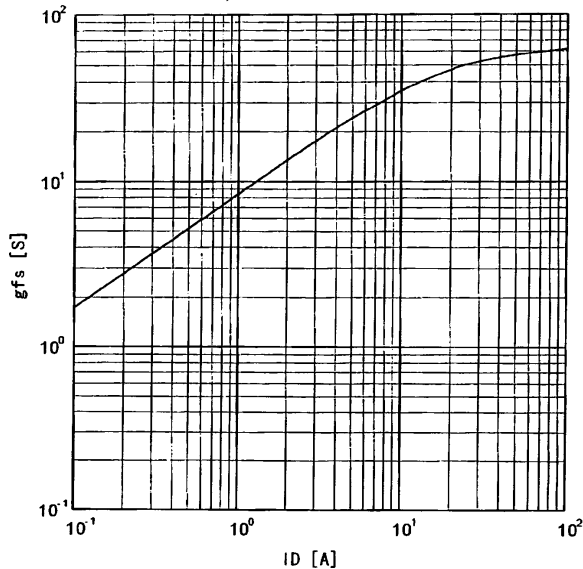

Typical Drain-Source on-State Resistance  
 $R_{DS(on)}=f(ID) : 80\mu s$  pulse test,  $T_{ch}=25^\circ C$

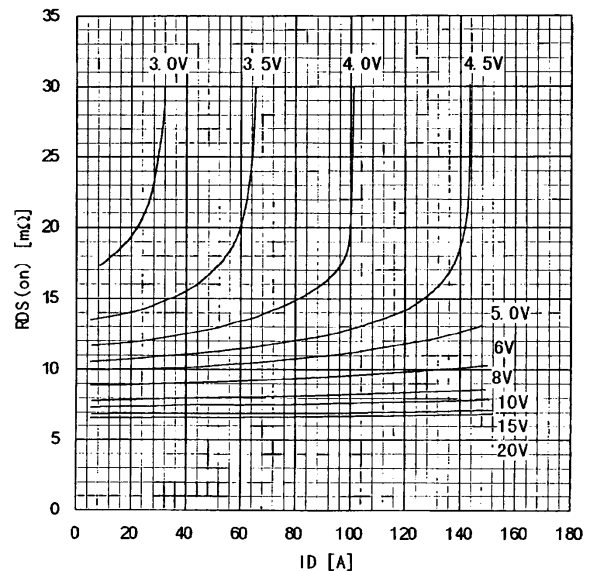

Drain-Source On-state Resistance  
 $R_{DS(on)} = f(T_{ch}) : I_D = 25A, V_{GS} = 10V$

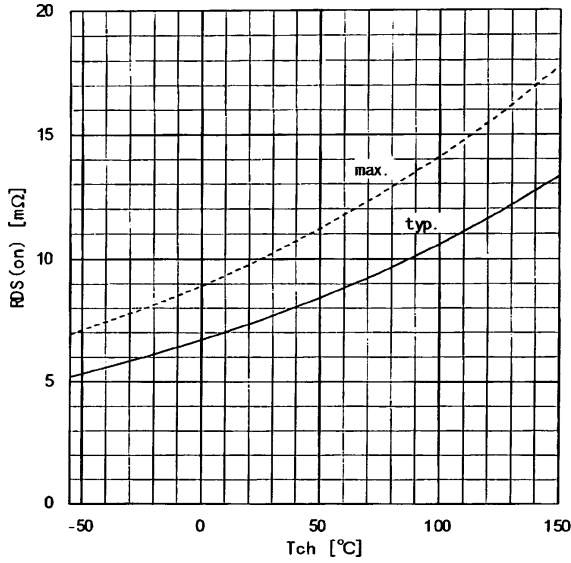

Gate Threshold Voltage vs.  $T_{ch}$   
 $V_{GS(th)} = f(T_{ch}) : V_{DS} = V_{GS}, I_D = 1mA$

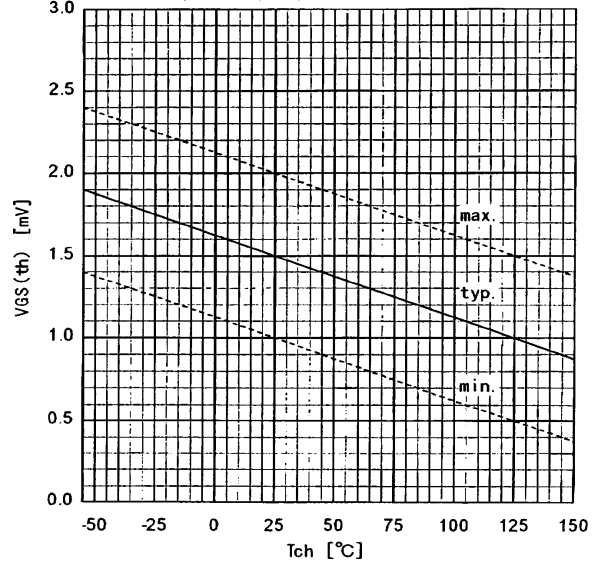

Typical Capacitance  
 $C = f(V_{DS}) : V_{GS} = 0V, f = 1MHz$

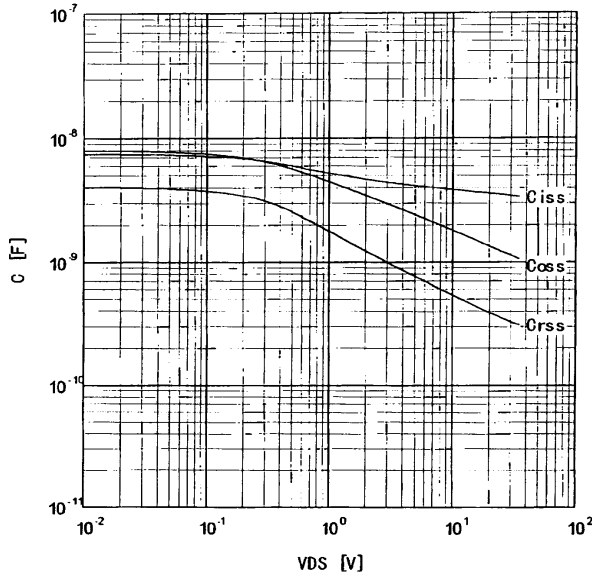

Typical Gate Charge Characteristics  
 $V_{GS} = f(Q_g) : I_D = 80A, T_{ch} = 25°C$

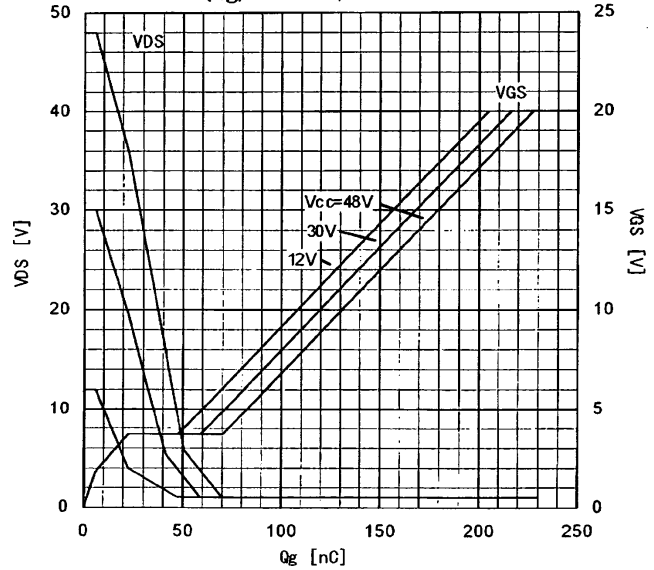

Typical Forward Characteristics of Reverse Diode  
 $I_F = f(V_{SD}) : 80\mu s \text{ pulse test}, T_{ch} = 25°C$

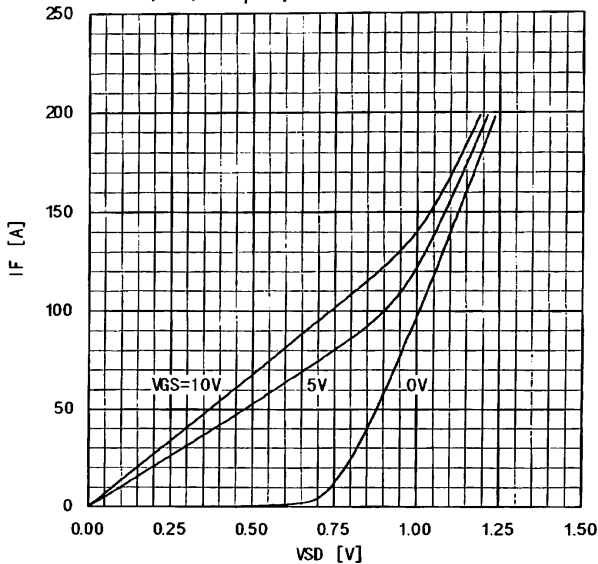

Typical Switching Characteristics vs.  $I_D$   
 $t = f(I_D) : V_{CC} = 30V, V_{GS} = 10V, R_G = 10\Omega$

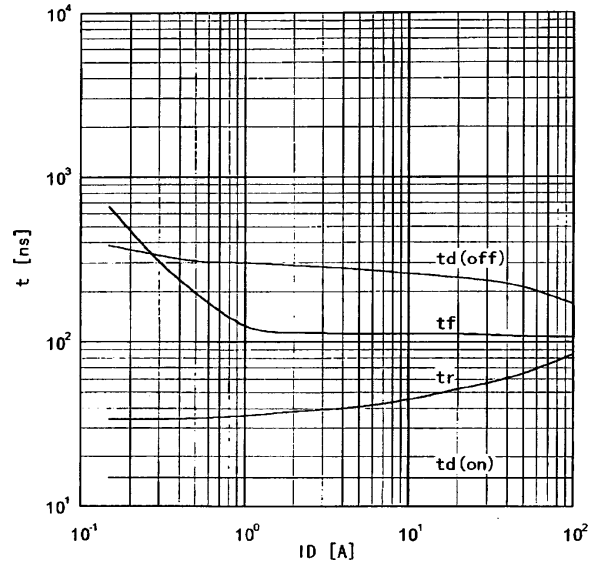

Maximum Avalanche Current vs. starting Tch  
 $I(AV) = f(\text{starting Tch})$

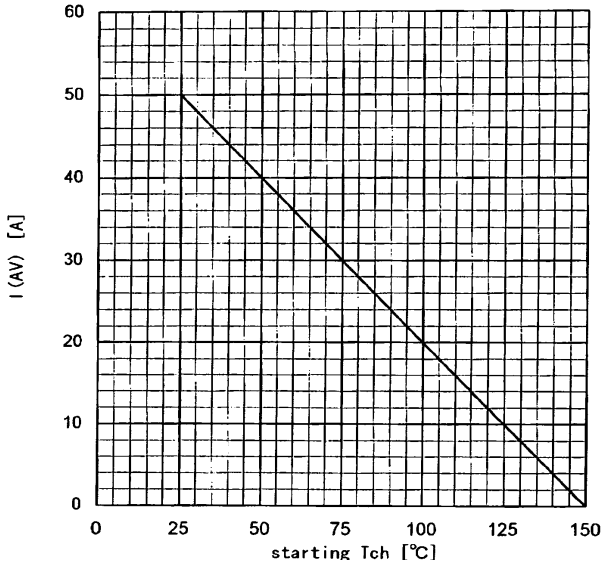

Maximum Avalanche Energy vs. starting Tch  
 $E(AV) = f(\text{starting Tch}) : V_{CC} = 24V, I(AV) \leq 50A$

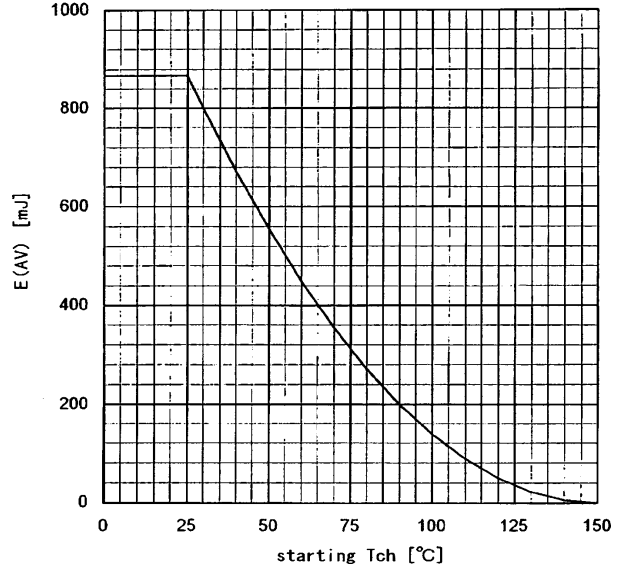

Transient thermal impedance  
 $Z_{thc} = f(t)$  parameter:  $D = t/T$

