

MOS FIELD EFFECT TRANSISTOR 2SK3366

SWITCHING N-CHANNEL POWER MOS FET INDUSTRIAL USE

DESCRIPTION

The 2SK3366 is N-Channel MOS Field Effect Transistor designed for DC/DC converter application of notebook computers.

FEATURES

- Low on-resistance
 $R_{DS(on)1} = 21 \text{ m}\Omega$ (MAX.) ($V_{GS} = 10 \text{ V}$, $I_D = 10 \text{ A}$)
 $R_{DS(on)2} = 33 \text{ m}\Omega$ (MAX.) ($V_{GS} = 4.5 \text{ V}$, $I_D = 10 \text{ A}$)
 $R_{DS(on)3} = 43 \text{ m}\Omega$ (MAX.) ($V_{GS} = 4.0 \text{ V}$, $I_D = 10 \text{ A}$)
- Low C_{iss} : $C_{iss} = 730 \text{ pF}$ (TYP.)
- Built-in gate protection diode

ORDERING INFORMATION

PART NUMBER	PACKAGE
2SK3366	TO-251
2SK3366-Z	TO-252

ABSOLUTE MAXIMUM RATINGS ($T_A = 25 \text{ }^\circ\text{C}$)

Drain to Source Voltage ($V_{GS} = 0 \text{ V}$)	V_{DSS}	30	V
Gate to Source Voltage ($V_{DS} = 0 \text{ V}$)	V_{GSS}	± 20	V
Drain Current (DC)	$I_{D(DC)}$	± 20	A
Drain Current (Pulse) ^{Note}	$I_{D(pulse)}$	± 80	A
Total Power Dissipation ($T_c = 25 \text{ }^\circ\text{C}$)	P_T	30	W
Total Power Dissipation ($T_A = 25 \text{ }^\circ\text{C}$)	P_T	1.0	W
Channel Temperature	T_{ch}	150	$^\circ\text{C}$
Storage Temperature	T_{stg}	-55 to + 150	$^\circ\text{C}$

Note $PW \leq 10 \text{ } \mu\text{s}$, Duty cycle $\leq 1 \%$

THERMAL RESISTANCE

Channel to case	$R_{th(ch-C)}$	4.17	$^\circ\text{C/W}$
Channel to ambient	$R_{th(ch-A)}$	125	$^\circ\text{C/W}$

The information in this document is subject to change without notice. Before using this document, please confirm that this is the latest version.
 Not all devices/types available in every country. Please check with local NEC representative for availability and additional information.

ELECTRICAL CHARACTERISTICS (T_A = 25 °C)

CHARACTERISTICS	SYMBOL	TEST CONDITIONS	MIN.	TYP.	MAX.	UNIT
Drain to Source On-state Resistance	R _{DS(on)1}	V _{GS} = 10 V, I _D = 10 A		17.2	21	mΩ
	R _{DS(on)2}	V _{GS} = 4.5 V, I _D = 10 A		26	33	mΩ
	R _{DS(on)3}	V _{GS} = 4.0 V, I _D = 10 A		33	43	mΩ
Gate to Source Cut-off Voltage	V _{GS(off)}	V _{DS} = 10 V, I _D = 1 mA	1.5	2.0	2.5	V
Forward Transfer Admittance	y _{fs}	V _{DS} = 10 V, I _D = 10 A	5	10		S
Drain Leakage Current	I _{DSS}	V _{DS} = 30 V, V _{GS} = 0 V			10	μA
Gate to Source Leakage Current	I _{GSS}	V _{GS} = ±20 V, V _{DS} = 0 V			±10	μA
Input Capacitance	C _{iSS}	V _{DS} = 10 V, V _{GS} = 0 V, f = 1 MHz		730		pF
Output Capacitance	C _{oSS}			250		pF
Reverse Transfer Capacitance	C _{rSS}			120		pF
Turn-on Delay Time	t _{d(on)}	I _D = 10 A, V _{GS(on)} = 10 V, V _{DD} = 15 V, R _G = 10 Ω		28		ns
Rise Time	t _r			420		ns
Turn-off Delay Time	t _{d(off)}			47		ns
Fall Time	t _f			64		ns
Total Gate Charge	Q _G	I _D = 20 A, V _{DD} = 24 V, V _{GS} = 10 V		15		nC
Gate to Source Charge	Q _{GS}			2.8		nC
Gate to Drain Charge	Q _{GD}			4.1		nC
Body Diode forward Voltage	V _{F(S-D)}	I _F = 20 A, V _{GS} = 0 V		1.0		V
Reverse Recovery Time	t _{rr}	I _F = 20 A, V _{GS} = 0 V di/dt = 100 A/μs		30		ns
Reverse Recovery Charge	Q _{rr}			26		nC

TEST CIRCUIT 1 SWITCHING TIME

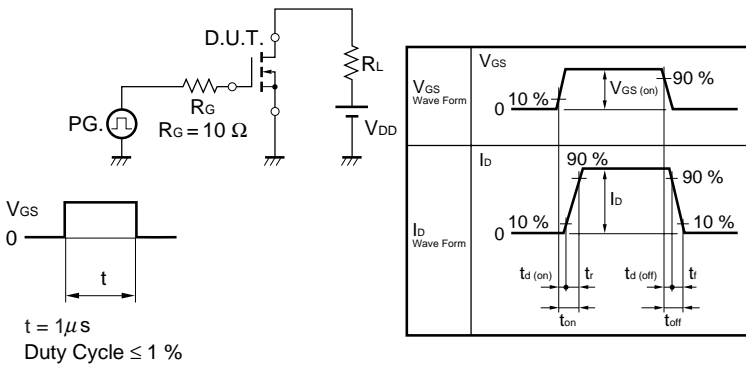

TEST CIRCUIT 2 GATE CHARGE

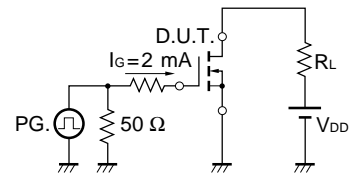

TYPICAL CHARACTERISTICS (T_A = 25 °C)

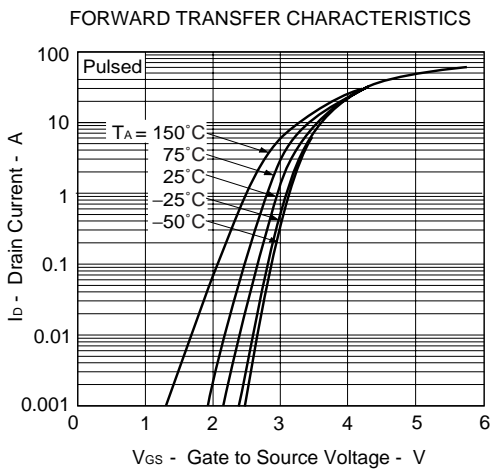
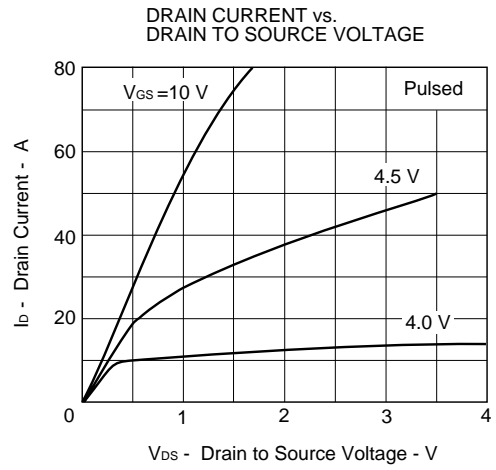
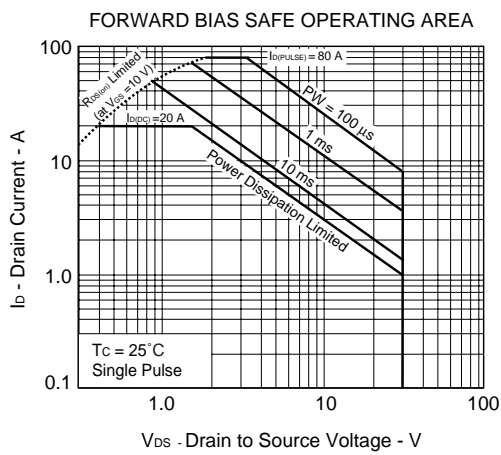
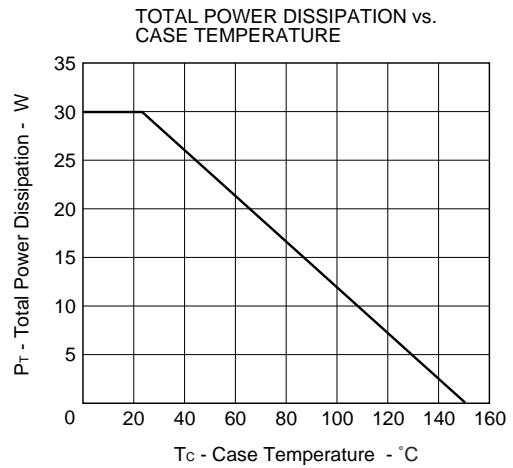
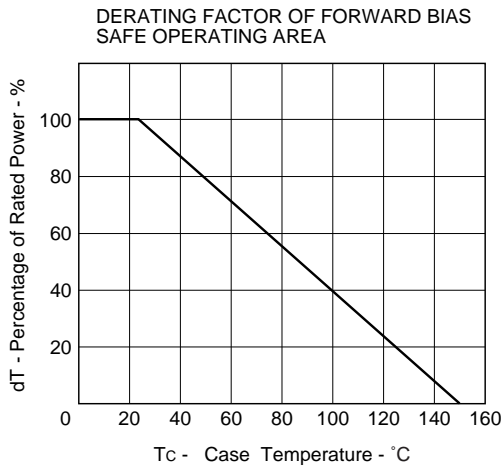

TRANSIENT THERMAL RESISTANCE vs. PULSE WIDTH

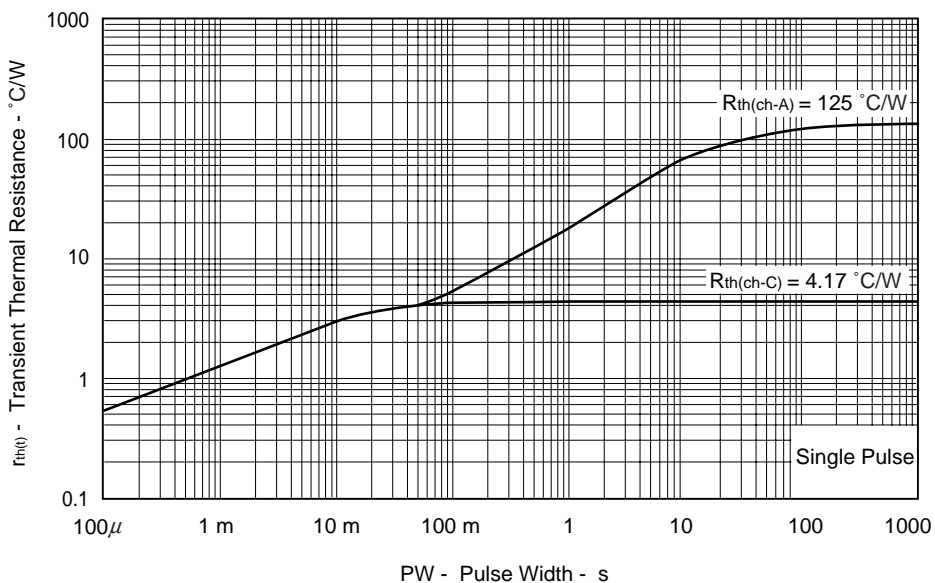

FORWARD TRANSFER ADMITTANCE vs. DRAIN CURRENT

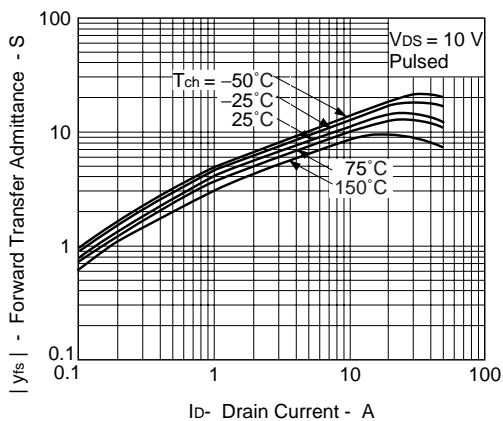

DRAIN TO SOURCE ON-STATE RESISTANCE vs. GATE TO SOURCE VOLTAGE

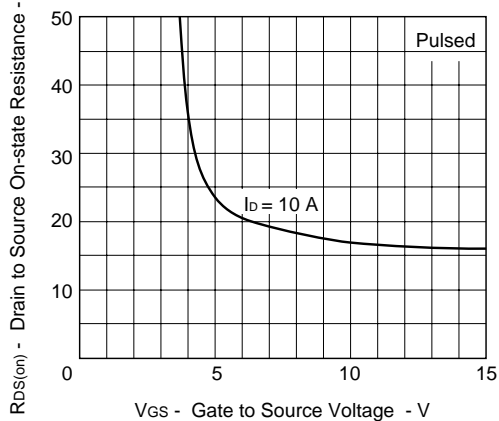

DRAIN TO SOURCE ON-STATE RESISTANCE vs. DRAIN CURRENT

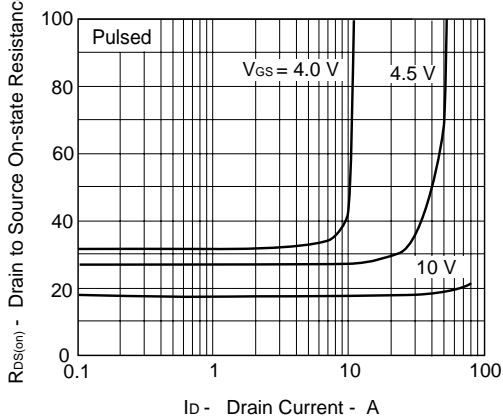

GATE TO SOURCE CUT-OFF VOLTAGE vs. CHANNEL TEMPERATURE

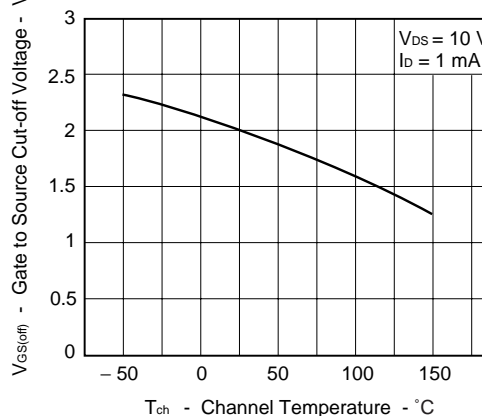

DRAIN TO SOURCE ON-STATE RESISTANCE vs. CHANNEL TEMPERATURE

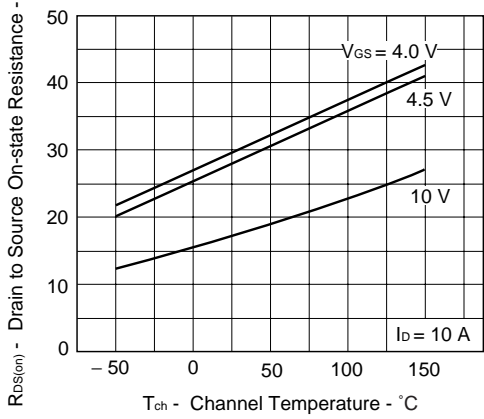

SOURCE TO DRAIN DIODE FORWARD VOLTAGE

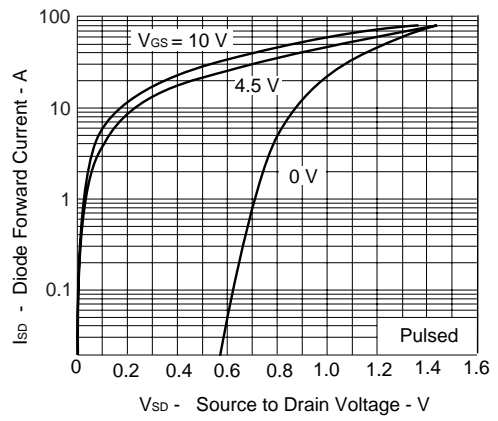

CAPACITANCE vs. DRAIN TO SOURCE VOLTAGE

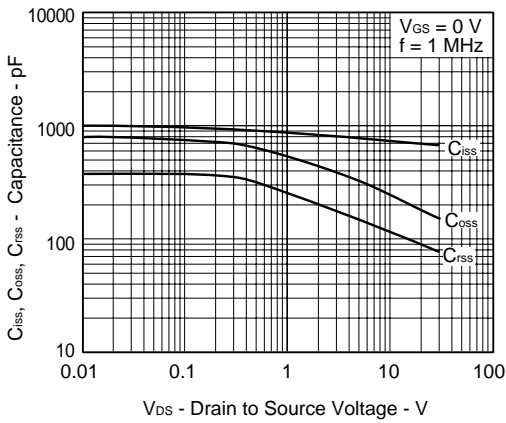

SWITCHING CHARACTERISTICS

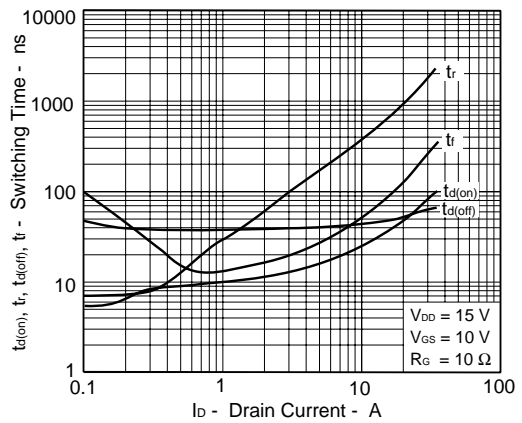

REVERSE RECOVERY TIME vs. DRAIN CURRENT

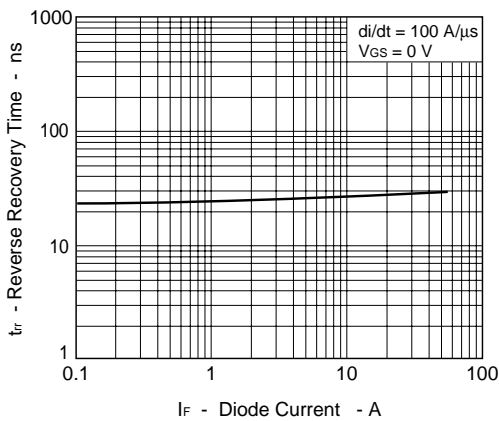

DYNAMIC INPUT/OUTPUT CHARACTERISTICS

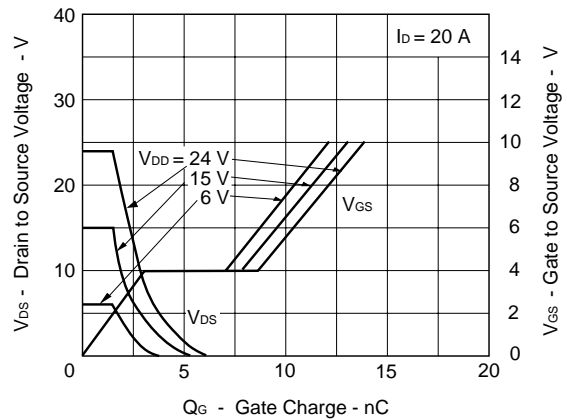

PACKAGE DRAWINGS (Unit : mm)

1) TO-251 (MP-3)

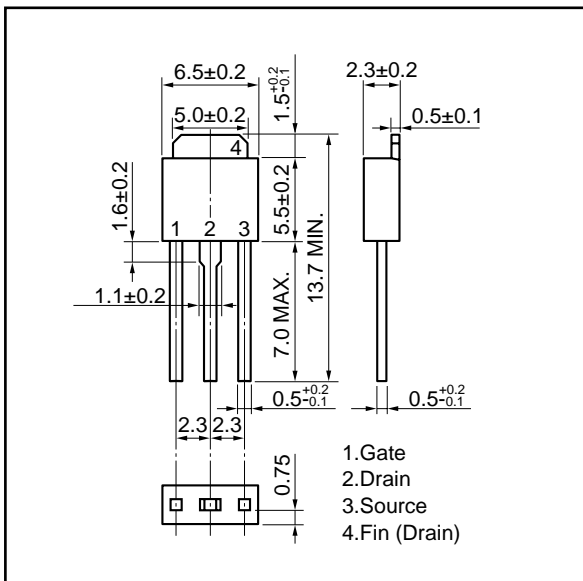

2) TO-252 (MP-3Z)

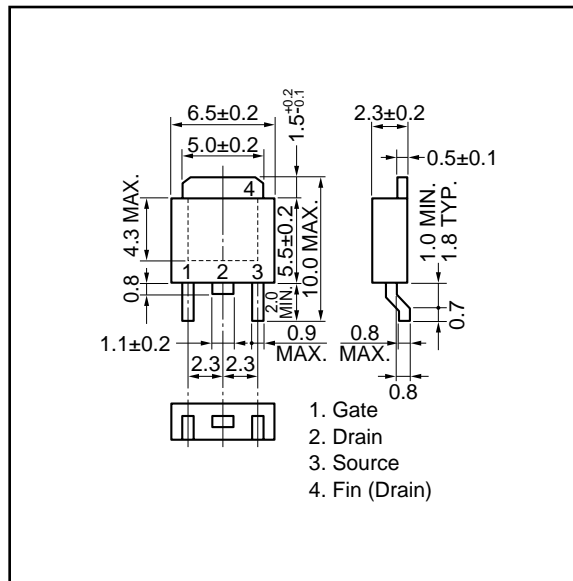

EQUIVALENT CIRCUIT

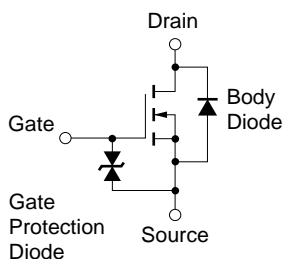

Remark The diode connected between the gate and source of the transistor serves as a protector against ESD. When this device actually used, an additional protection circuit is externally required if a voltage exceeding the rated voltage may be applied to this device.

[MEMO]

[MEMO]

- **The information in this document is subject to change without notice. Before using this document, please confirm that this is the latest version.**
 - No part of this document may be copied or reproduced in any form or by any means without the prior written consent of NEC Corporation. NEC Corporation assumes no responsibility for any errors which may appear in this document.
 - NEC Corporation does not assume any liability for infringement of patents, copyrights or other intellectual property rights of third parties by or arising from use of a device described herein or any other liability arising from use of such device. No license, either express, implied or otherwise, is granted under any patents, copyrights or other intellectual property rights of NEC Corporation or others.
 - Descriptions of circuits, software, and other related information in this document are provided for illustrative purposes in semiconductor product operation and application examples. The incorporation of these circuits, software, and information in the design of the customer's equipment shall be done under the full responsibility of the customer. NEC Corporation assumes no responsibility for any losses incurred by the customer or third parties arising from the use of these circuits, software, and information.
 - While NEC Corporation has been making continuous effort to enhance the reliability of its semiconductor devices, the possibility of defects cannot be eliminated entirely. To minimize risks of damage or injury to persons or property arising from a defect in an NEC semiconductor device, customers must incorporate sufficient safety measures in its design, such as redundancy, fire-containment, and anti-failure features.
 - NEC devices are classified into the following three quality grades:
"Standard", "Special", and "Specific". The Specific quality grade applies only to devices developed based on a customer designated "quality assurance program" for a specific application. The recommended applications of a device depend on its quality grade, as indicated below. Customers must check the quality grade of each device before using it in a particular application.
 - Standard: Computers, office equipment, communications equipment, test and measurement equipment, audio and visual equipment, home electronic appliances, machine tools, personal electronic equipment and industrial robots
 - Special: Transportation equipment (automobiles, trains, ships, etc.), traffic control systems, anti-disaster systems, anti-crime systems, safety equipment and medical equipment (not specifically designed for life support)
 - Specific: Aircraft, aerospace equipment, submersible repeaters, nuclear reactor control systems, life support systems or medical equipment for life support, etc.
- The quality grade of NEC devices is "Standard" unless otherwise specified in NEC's Data Sheets or Data Books. If customers intend to use NEC devices for applications other than those specified for Standard quality grade, they should contact an NEC sales representative in advance.