

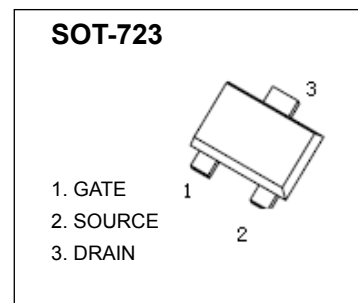

SOT-723 Plastic-Encapsulate MOSFETS

2SK3541 N-Channel MOSFET

$V_{(BR)DSS}$	$R_{DS(on)MAX}$	I_D
30V	8Ω@4V	100mA
	13Ω@2.5V	



FEATURE

- Low on-resistance
- Fast switching speed
- Low voltage drive makes this device ideal for Portable equipment
- Drive circuits can be simple
- Parallel use is easy

APPLICATION

- Interfacing , Switching

MARKING

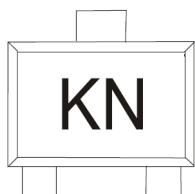

Equivalent Circuit

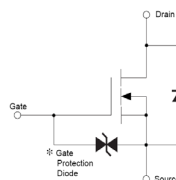

Maximum ratings ($T_a=25^{\circ}C$ unless otherwise noted)

Parameter	Symbol	Value	Unit
Drain-source voltage	V_{DS}	30	V
Gate-source voltage	V_{GS}	±20	
Continuous drain current	I_D	±100	mA
Power dissipation	P_D	0.15	W
Thermal resistance from junction to ambient	$R_{\theta JA}$	833	$^{\circ}C/W$
Junction temperature	T_J	150	$^{\circ}C$
Storage temperature	T_{stg}	-55 ~+150	

* $P_w \leq 10\mu s$, Duty cycles $\leq 1\%$

MOSFET ELECTRICAL CHARACTERISTICS

$T_a=25\text{ }^\circ\text{C}$ unless otherwise specified

Parameter	Symbol	Test Condition	Min	Typ	Max	Unit
Drain-source breakdown voltage	$V_{(BR)DSS}$	$V_{GS} = 0V, I_D = 10\mu A$	30			V
Gate-source leakage current	I_{GSS}	$V_{DS} = 0V, V_{GS} = \pm 20V$			± 2	μA
Zero gate voltage drain current	I_{DSS}	$V_{DS} = 30V, V_{GS} = 0V$			1.0	μA
Gate threshold voltage	$V_{GS(th)}$	$V_{DS} = 3V, I_D = 100\mu A$	0.8		1.5	V
Static drain-source on-state resistance	$R_{DS(on)}$	$V_{GS} = 4V, I_D = 10mA$		5	8	Ω
		$V_{GS} = 2.5V, I_D = 1mA$		7	13	
Forward transconductance	g_{FS}	$V_{DS} = 3V, I_D = 10mA$	20			mS
Input capacitance	C_{iss}	$V_{DS} = 5V, V_{GS} = 0V, f = 1MHz$		13		pF
Output capacitance	C_{oss}			9		
Reverse transfer capacitance	C_{rss}			4		
Turn-on delay time	$t_{d(on)}$	$V_{GS} = 5V, V_{DD} = 5V, I_D = 10mA$ $R_L = 500\Omega, R_G = 10\Omega$		15		ns
Rise time	t_r			35		
Turn-off delay time	$t_{d(off)}$			80		
Fall time	t_f			80		

Typical Characteristics

Output Characteristics

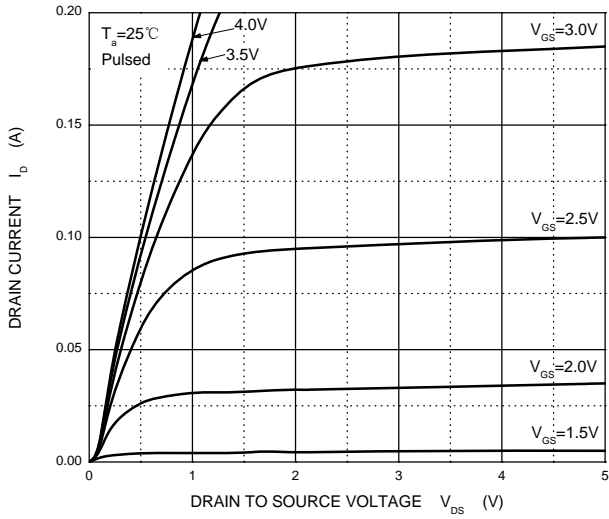

Transfer Characteristics

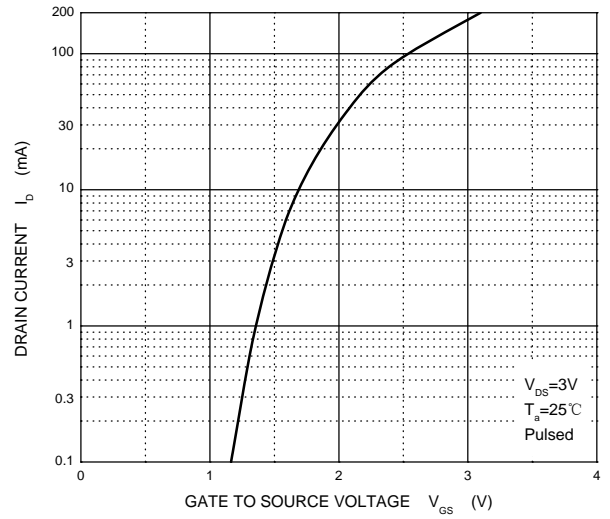

$R_{DS(ON)}$ — I_D

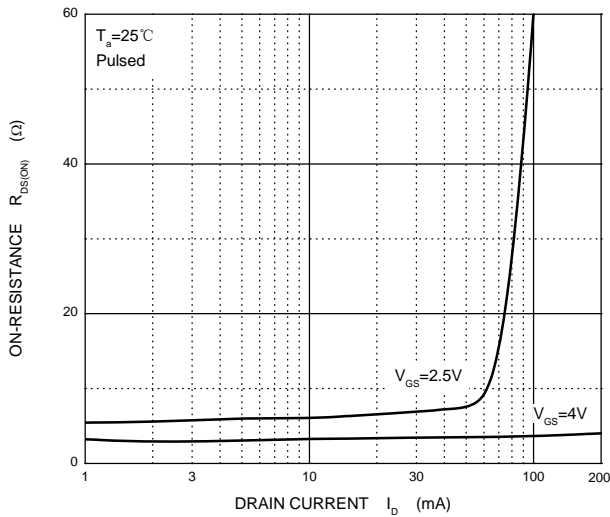

$R_{DS(ON)}$ — V_{GS}

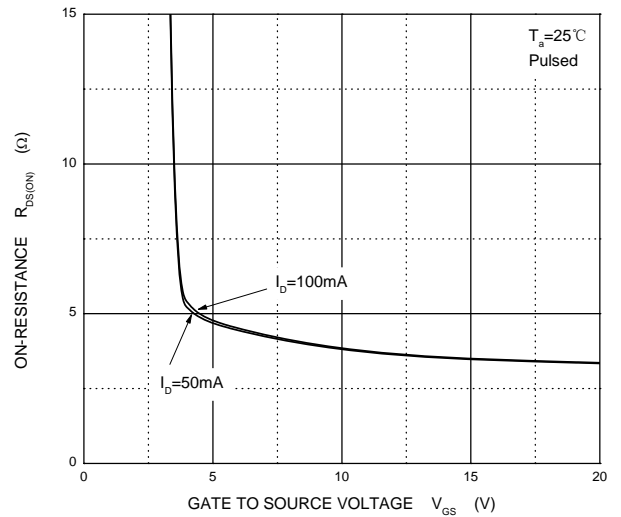

I_S — V_{SD}

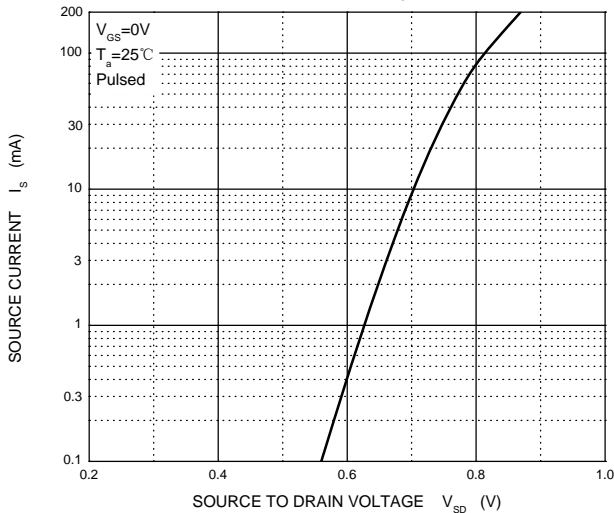

SOT-723 Package Outline Dimensions

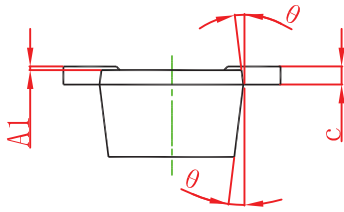
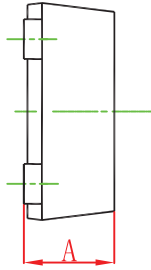
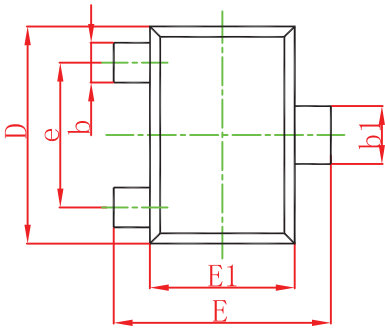

Symbol	Dimensions In Millimeters		Dimensions In Inches	
	Min.	Max.	Min.	Max.
A	0.430	0.500	0.017	0.020
A1	0.000	0.050	0.000	0.002
b	0.170	0.270	0.007	0.011
b1	0.270	0.370	0.011	0.015
c	0.080	0.150	0.003	0.006
D	1.150	1.250	0.045	0.049
E	1.150	1.250	0.045	0.049
E1	0.750	0.850	0.030	0.033
e	0.800TYP.		0.031TYP.	
θ	7° REF.		7° REF.	

SOT-723 Suggested Pad Layout

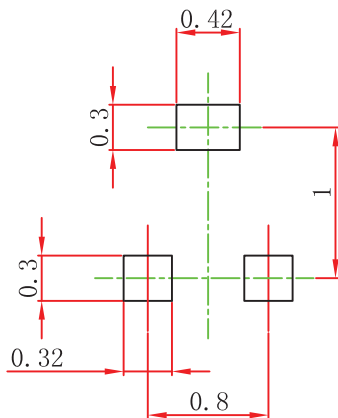

Note:

1. Controlling dimension: in millimeters.
2. General tolerance: $\pm 0.05\text{mm}$.
3. The pad layout is for reference purposes only.

NOTICE

JCET reserve the right to make modifications, enhancements, improvements, corrections or other changes without further notice to any product herein. JCET does not assume any liability arising out of the application or use of any product described herein.

SOT-723 Tape and reel

SOT-723 Embossed Carrier Tape

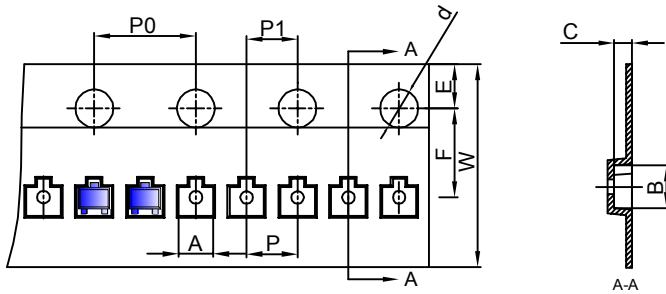

Packaging Description:
 SOT-723 parts are shipped in tape. The carrier tape is made from a dissipative (carbon filled) polycarbonate resin. The cover tape is a multilayer film (Heat Activated Adhesive in nature) primarily composed of polyester film, adhesive layer, sealant, and anti-static sprayed agent. These reeled parts in standard option are shipped with 8,000 units per 7" or 17.8cm diameter reel. The reels are clear in color and is made of polystyrene plastic (anti-static coated).

Dimensions are in millimeter										
Pkg type	A	B	C	d	E	F	P0	P	P1	W
SOT-723	1.33	1.45	0.61	Ø1.50	1.75	3.50	4.00	2.00	2.00	8.00

SOT-723 Tape Leader and Trailer

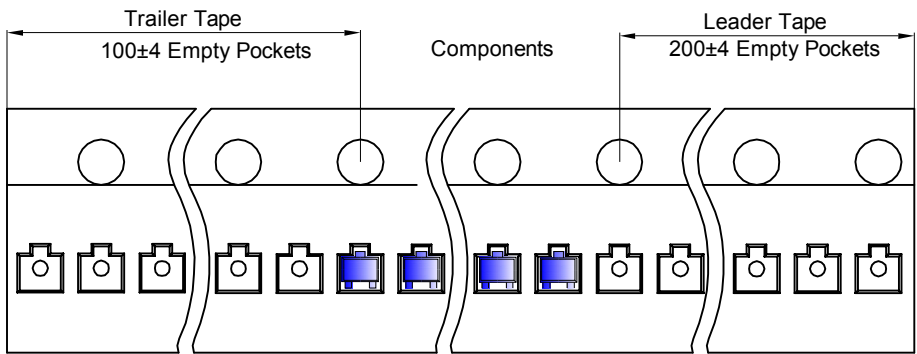

SOT-723 Reel

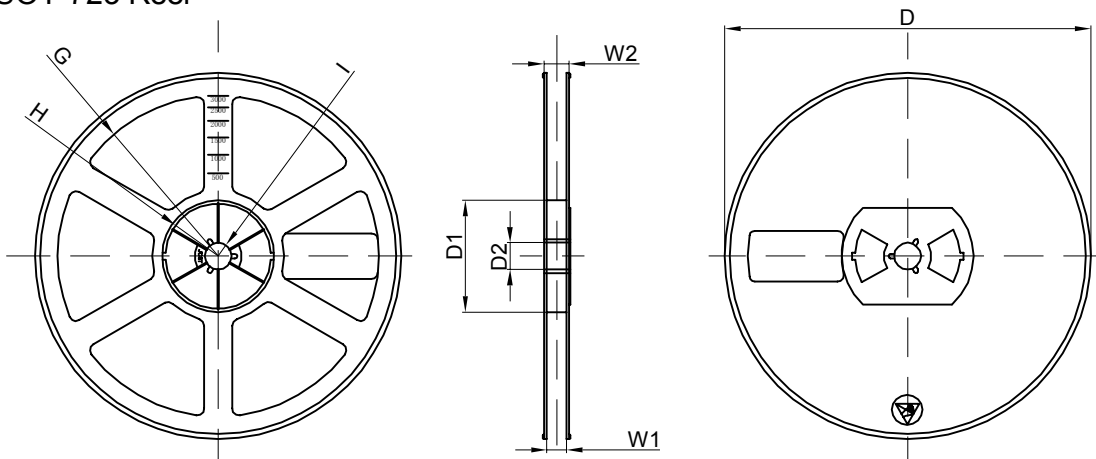

Dimensions are in millimeter								
Reel Option	D	D1	D2	G	H	I	W1	W2
7" Dia	Ø178.00	54.40	13.00	R78.00	R25.60	R6.50	9.50	12.30

REEL	Reel Size	Box	Box Size(mm)	Carton	Carton Size(mm)	G.W.(kg)
8000 pcs	7 inch	80,000 pcs	203×203×195	320,000 pcs	438×438×220	