

FUJI POWER MOSFET Super FAP-G Series

N-CHANNEL SILICON POWER MOSFET

Features

- High speed switching
- Low on-resistance
- No secondary breakdown
- Low driving power
- Avalanche-proof

Applications

- Switching regulators
- DC-DC converters
- UPS (Uninterruptible Power Supply)

Maximum ratings and characteristic Absolute maximum ratings

(T_c=25°C unless otherwise specified)

Item	Symbol	Ratings	Unit	Remarks
Drain-source voltage	V _{DS}	500	V	
Continuous drain current	I _D	±13	A	
Pulsed drain current	I _D (puls)	±52	A	
Gate-source voltage	V _{GS}	±30	V	
Non-Repetitive Maximum avalanche current	I _{AS}	13	A	T _{ch} ≤ 150°C
Non-Repetitive Maximum avalanche energy	E _{AS}	202	mJ	*1
Maximum Drain-Source dV/dt	dV _{DS} /dt	20	kV/s	V _{DS} ≤ 500V
Peak diode recovery dV/dt	dV/dt	5	kV/μs	*2
Peak diode recovery -di/dt	-di/dt	100	A/μs	*3
Max. power dissipation	P _D	2.02	W	T _a =25°C
		195		T _c =25°C
Operating and storage temperature range	T _{ch}	+150	°C	
	T _{stg}	-55 to +150	°C	

*1 L=2.20mH, V_{CC}=50V, Starting T_{ch}=25°C, See to Avalanche Energy Graph

*2 I_F ≤ -I_D, -di/dt=100A/μs, V_{CC} ≤ BV_{DSS}, T_{ch} ≤ 150°C

*3 I_F ≤ -I_D, dV/dt=5kV/μs, V_{CC} ≤ BV_{DSS}, T_{ch} ≤ 150°C

Electrical characteristics (T_c =25°C unless otherwise specified)

Item	Symbol	Test Conditions	Min.	Typ.	Max.	Units
Drain-source breakdown voltage	V _{(BR)DSS}	I _D =250μA V _{GS} =0V	500			V
Gate threshold voltage	V _{GS(th)}	I _D =250μA V _{DS} =V _{GS}	3.0		5.0	V
Zero gate voltage drain current	I _{DSS}	V _{DS} =500V V _{GS} =0V T _{ch} =25°C		10	25	μA
		V _{DS} =400V V _{GS} =0V T _{ch} =125°C		1.0	2	mA
Gate-source leakage current	I _{GSS}	V _{GS} =±30V V _{DS} =0V		10	100	nA
Drain-source on-state resistance	R _{DS(on)}	I _D =6.5A V _{GS} =10V		0.42	0.55	Ω
Forward transconductance	g _{fs}	I _D =6.5A V _{DS} =25V	5.5	11		S
Input capacitance	C _{iss}	V _{DS} =25V		1100	1650	pF
Output capacitance	C _{oss}	V _{GS} =0V		165	250	pF
Reverse transfer capacitance	C _{rss}	f=1MHz		9	13.5	pF
Turn-on time t _{on}	t _{d(on)}	V _{CC} =300V I _D =6.5A		23	35	ns
	t _r	V _{GS} =10V		6.5	11	
Turn-off time t _{off}	t _{d(off)}	R _{GS} =10Ω		47	71	ns
	t _f			7.5	12	
Total Gate Charge	Q _G	V _{CC} =250V		28	42	nC
Gate-Source Charge	Q _{GS}	I _D =13A		10	15	
Gate-Drain Charge	Q _{GD}	V _{GS} =10V		9	14	
Avalanche capability	I _{AV}	L=2.20mH T _{ch} =25°C	13			A
Diode forward on-voltage	V _{SD}	I _F =13A V _{GS} =0V T _{ch} =25°C		1.20	1.80	V
Reverse recovery time	t _{rr}	I _F =13A V _{GS} =0V		120	250	ns
Reverse recovery charge	Q _{rr}	-di/dt=100A/μs T _{ch} =25°C		0.5	1.2	μC

Thermal characteristics

Item	Symbol	Test Conditions	Min.	Typ.	Max.	Units
Thermal resistance	R _{th(ch-c)}	channel to case			0.64	°C/W
	R _{th(ch-a)}	channel to ambient			62.0	°C/W

Outline Drawings [mm]

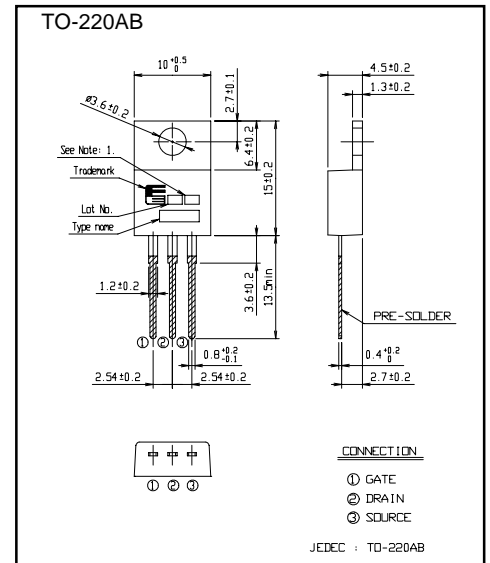

Equivalent circuit schematic

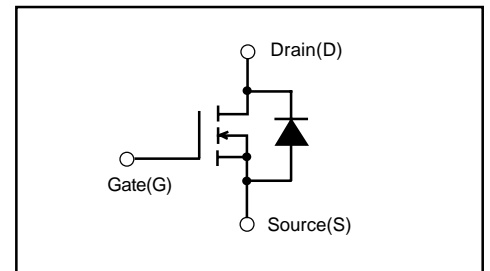

Characteristics

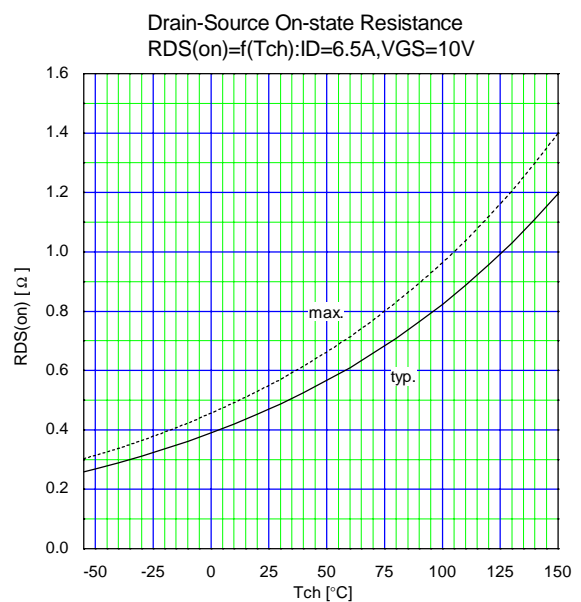
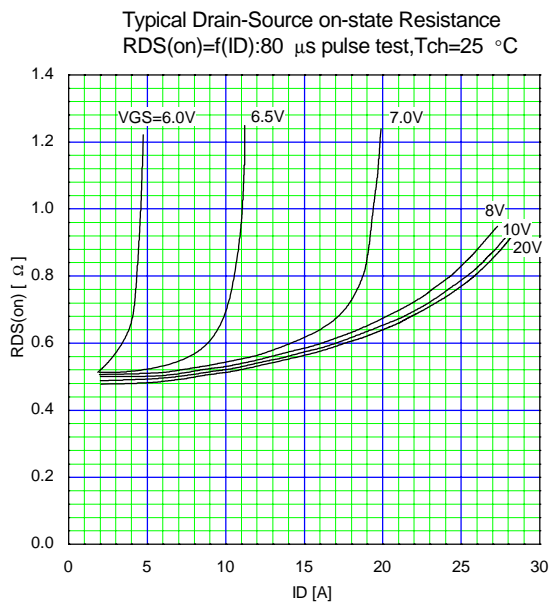
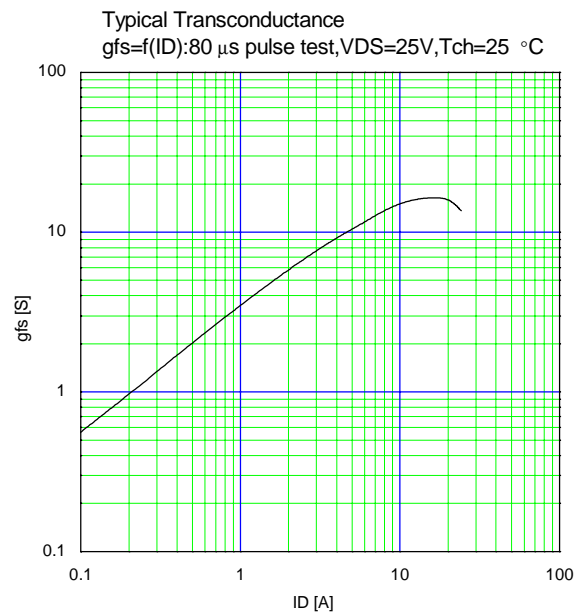
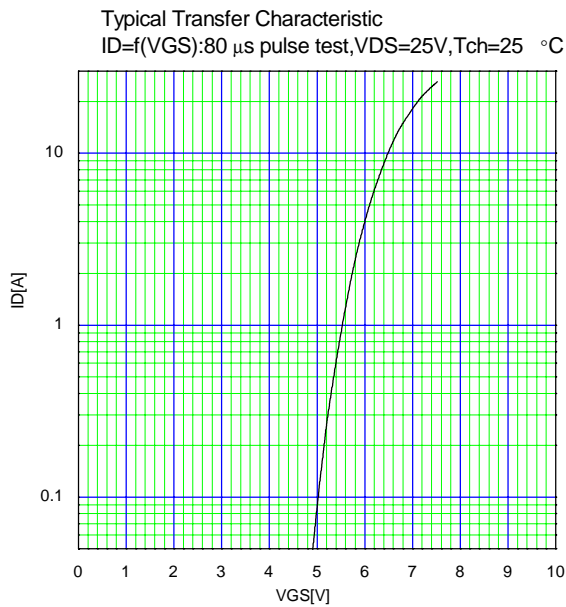
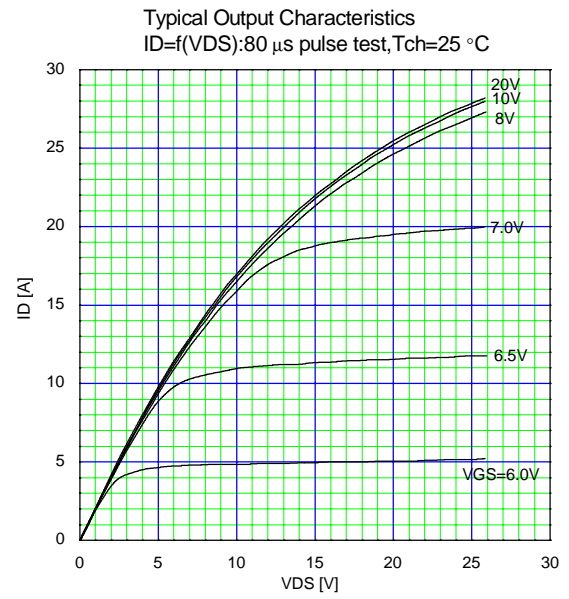
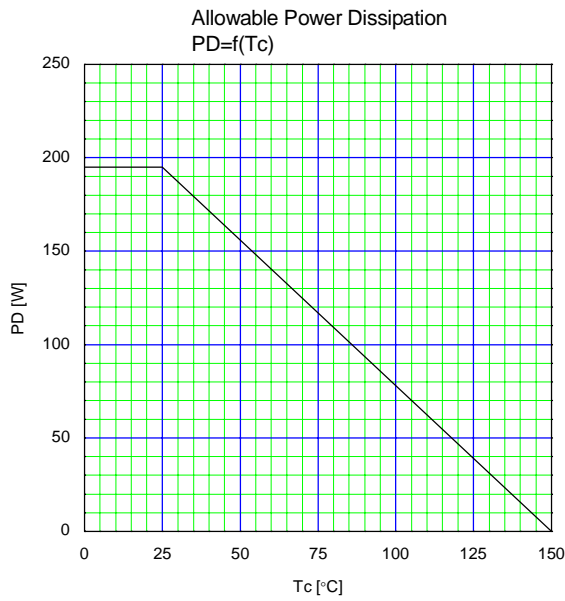

Gate Threshold Voltage vs. T_{ch}
 $V_{GS(th)} = f(T_{ch}) : V_{DS} = V_{GS}, I_D = 250\mu A$

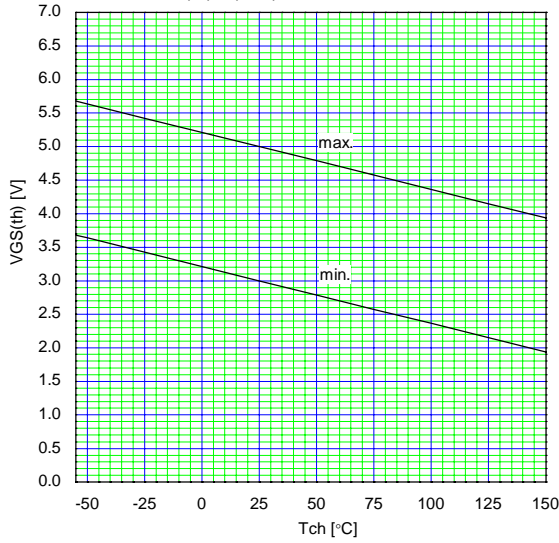

Typical Gate Charge Characteristics
 $V_{GS} = f(Q_g) : I_D = 13A, T_{ch} = 25\text{ }^\circ C$

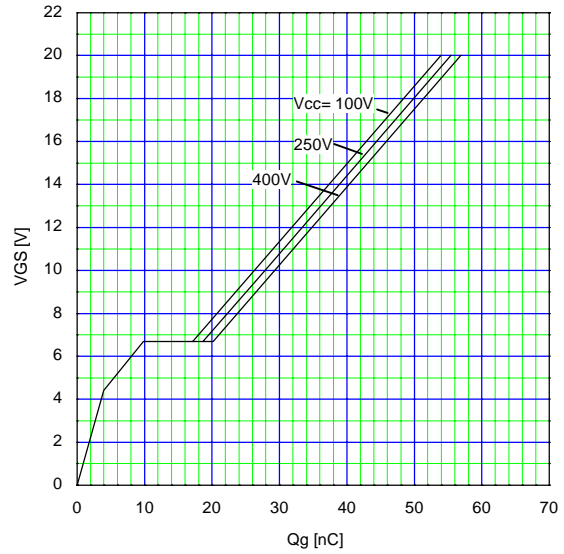

Typical Capacitance
 $C = f(V_{DS}) : V_{GS} = 0V, f = 1MHz$

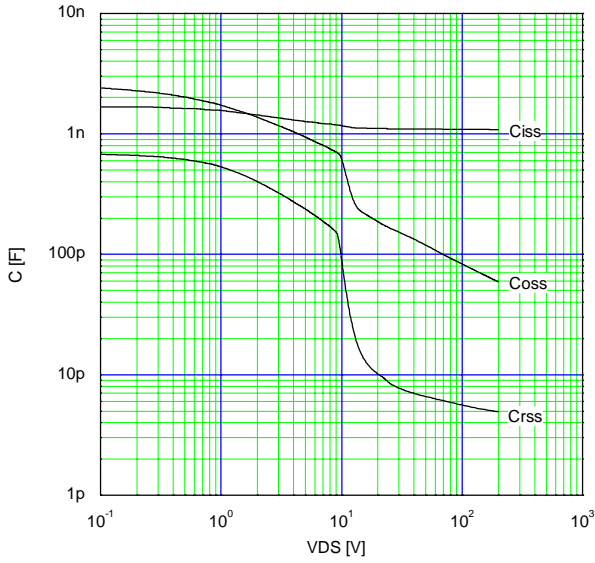

Typical Forward Characteristics of Reverse Diode
 $I_F = f(V_{SD}) : 80\mu s \text{ pulse test}, T_{ch} = 25\text{ }^\circ C$

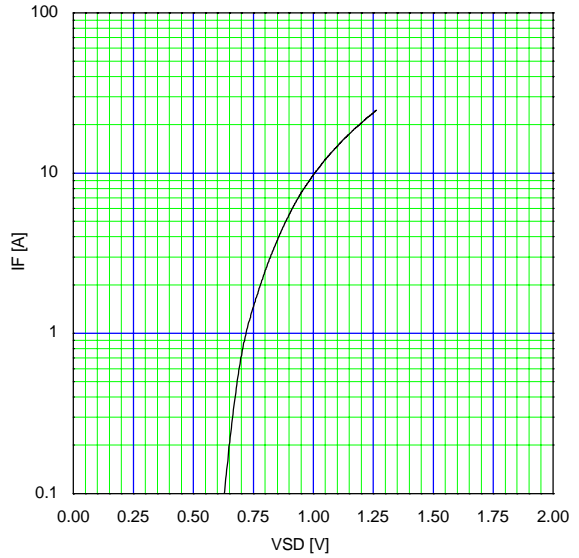

Typical Switching Characteristics vs. I_D
 $t = f(I_D) : V_{cc} = 300V, V_{GS} = 10V, R_G = 10\text{ } \Omega$

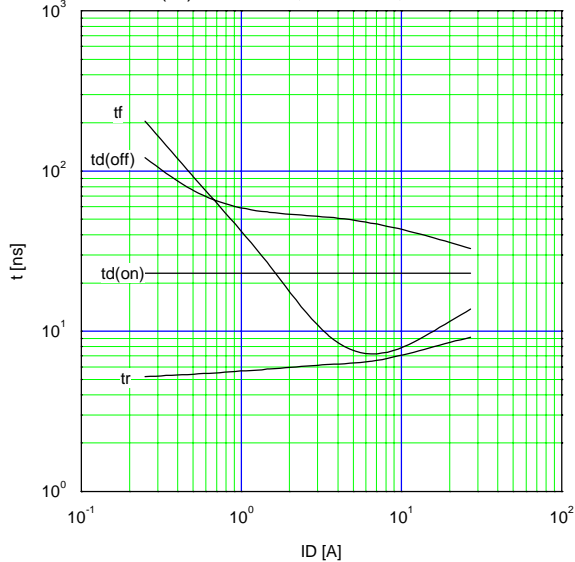

Maximum Avalanche Energy vs. starting T_{ch}
 $E_{AS} = f(\text{starting } T_{ch}) : V_{cc} = 50V$

