

# 2SK623

## SILICON N-CHANNEL MOS FET

### HIGH SPEED POWER SWITCHING

#### ■ FEATURES

- Low On-Resistance
- High Speed Switching
- Low Drive Current
- No Secondary Breakdown
- Suitable for Switching Regulator, DC-DC Converter and Motor Driver

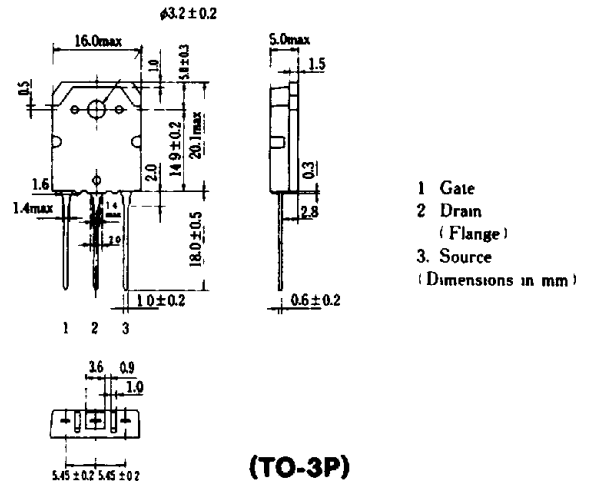
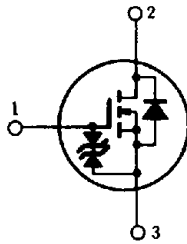

#### ■ ABSOLUTE MAXIMUM RATINGS ( $T_a=25^\circ\text{C}$ )

Item	Symbol	Rating	Unit
Drain-Source Voltage	$V_{DSS}$	250	V
Gate-Source Voltage	$V_{GSS}$	$\pm 20$	V
Drain Current	$I_D$	20	A
Drain Peak Current	$I_{D(pulse)}$ *	80	A
Body-Drain Diode Reverse Drain Current	$I_{DR}$	20	A
Channel Dissipation	$P_{ca}$ **	120	W
Channel Temperature	$T_{ca}$	150	$^\circ\text{C}$
Storage Temperature	$T_{stg}$	$-55 \sim +150$	$^\circ\text{C}$

\* $PW \leq 10\mu\text{s}$ , duty cycle  $\leq 1\%$

\*\*Value at  $T_c=25^\circ\text{C}$

#### POWER VS. TEMPERATURE DERATING

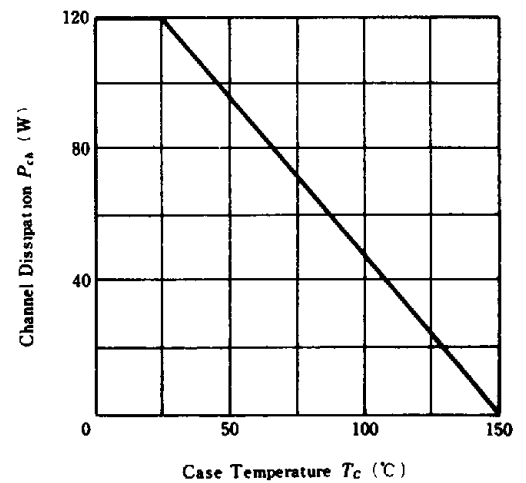

#### ■ ELECTRICAL CHARACTERISTICS ( $T_a=25^\circ\text{C}$ )

Item	Symbol	Test Condition	min.	typ.	max.	Unit
Drain-Source Breakdown Voltage	$V_{(BR)DSS}$	$I_D=10\text{mA}$ , $V_{GS}=0$	250	—	—	V
Gate-Source Breakdown Voltage	$V_{(BR)GSS}$	$I_G=\pm 100\mu\text{A}$ , $V_{DS}=0$	$\pm 20$	—	—	V
Gate-Source Leak Current	$I_{GSS}$	$V_{GS}=\pm 16\text{V}$ , $V_{DS}=0$	—	—	$\pm 10$	$\mu\text{A}$
Zero Gate Voltage Drain Current	$I_{DSS}$	$V_{DS}=200\text{V}$ , $V_{GS}=0$	—	—	250	$\mu\text{A}$
Gate-Source Cutoff Voltage	$V_{GS(off)}$	$I_D=1\text{mA}$ , $V_{DS}=10\text{V}$	2.0	—	4.0	V
Static Drain-Source on State Resistance	$R_{DS(on)}$	$I_D=10\text{A}$ , $V_{GS}=10\text{V}$ *	—	0.12	0.15	$\Omega$
Forward Transfer Admittance	$ y_{fs} $	$I_D=10\text{A}$ , $V_{DS}=10\text{V}$ *	7	12	—	S
Input Capacitance	$C_{iss}$	$V_{DS}=10\text{V}$ , $V_{GS}=0$ , $f=1\text{MHz}$	—	2000	—	pF
Output Capacitance	$C_{oss}$		—	950	—	pF
Reverse Transfer Capacitance	$C_{rss}$		—	270	—	pF
Turn-on Delay Time	$t_{d(on)}$		—	25	—	ns
Rise Time	$t_r$	$I_D=10\text{A}$ , $V_{GS}=10\text{V}$ , $R_L=3\Omega$	—	200	—	ns
Turn-off Delay Time	$t_{d(off)}$		—	200	—	ns
Fall Time	$t_f$		—	160	—	ns
Body-Drain Diode Forward Voltage	$V_{DF}$		$I_F=20\text{A}$ , $V_{GS}=0$	—	1.2	—
Body-Drain Diode Reverse Recovery Time	$t_{rr}$	$I_F=20\text{A}$ , $V_{GS}=0$ , $di_F/dt=50\text{A}/\mu\text{s}$	—	450	—	ns

\*Pulse Test

**MAXIMUM SAFE OPERATION AREA**

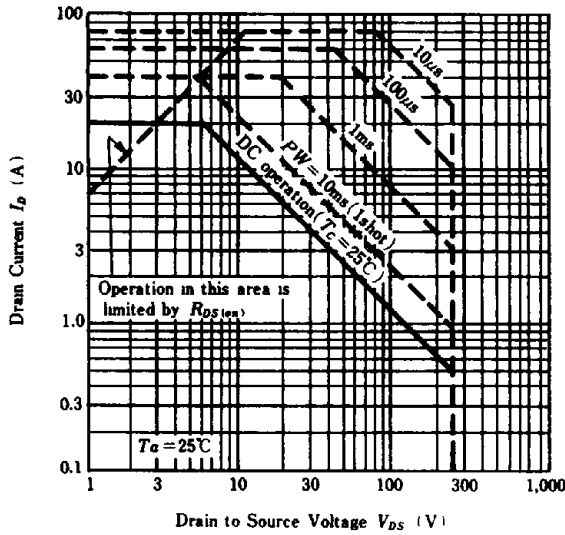

**TYPICAL OUTPUT CHARACTERISTICS**

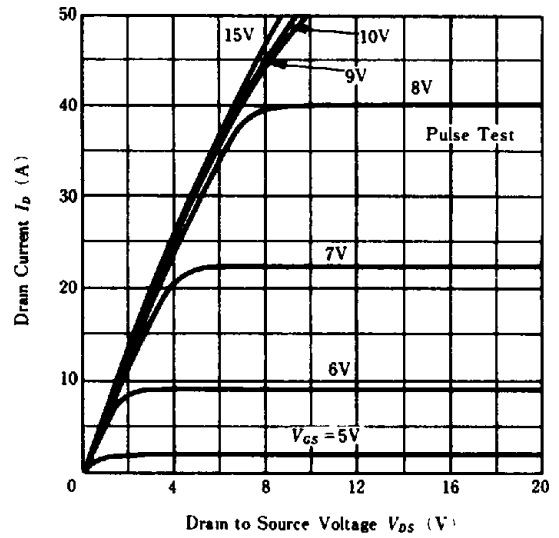

**TYPICAL TRANSFER CHARACTERISTICS**

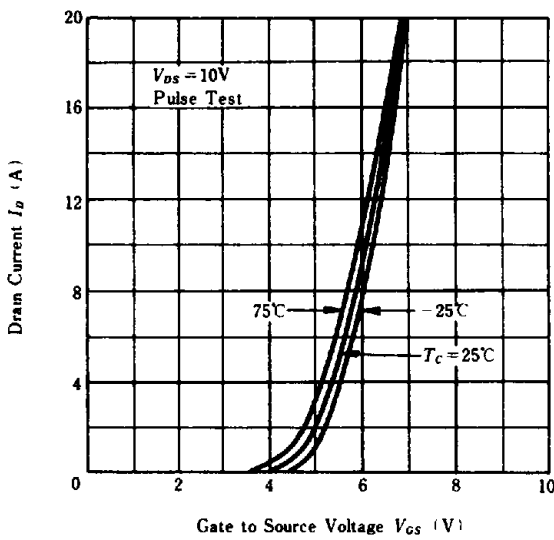

**DRAIN-SOURCE SATURATION VOLTAGE VS. GATE-SOURCE VOLTAGE**

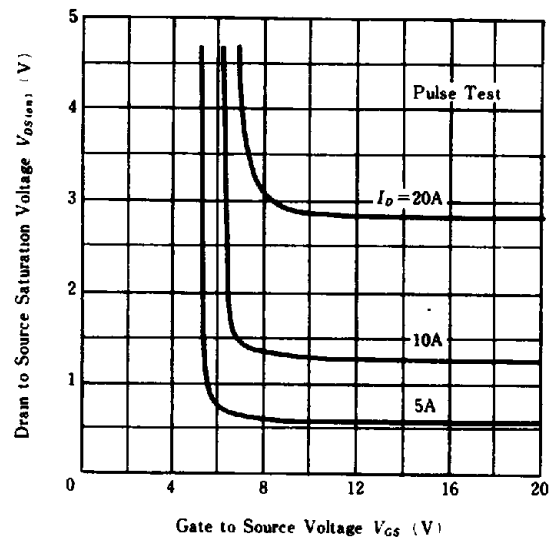

**STATIC DRAIN-SOURCE ON STATE RESISTANCE VS. DRAIN CURRENT**

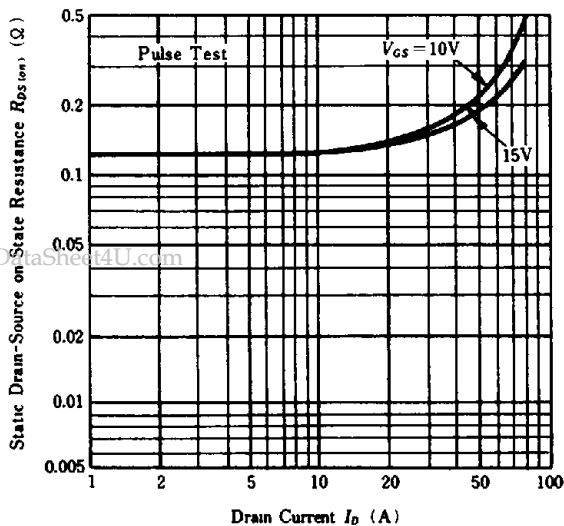

**STATIC DRAIN-SOURCE ON STATE RESISTANCE VS. TEMPERATURE**

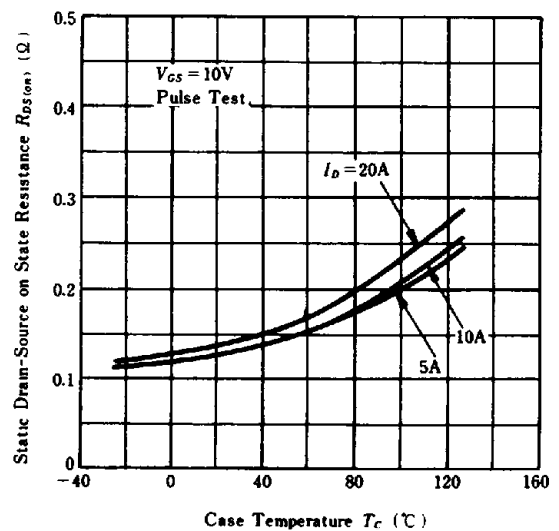

www.DataSheet4U.com

**FORWARD TRANSFER ADMITTANCE VS. DRAIN CURRENT**

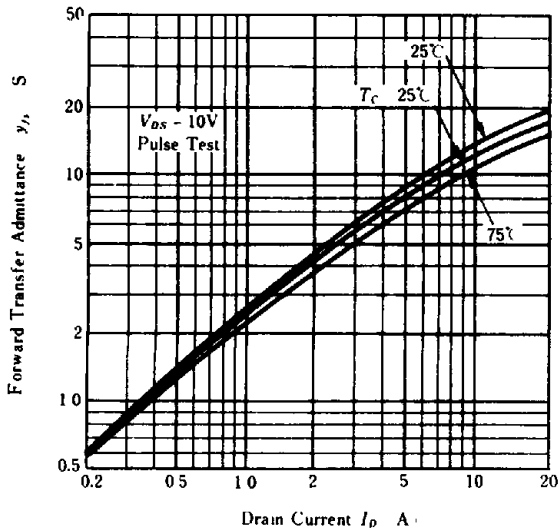

**BODY-DRAIN DIODE REVERSE RECOVERY TIME**

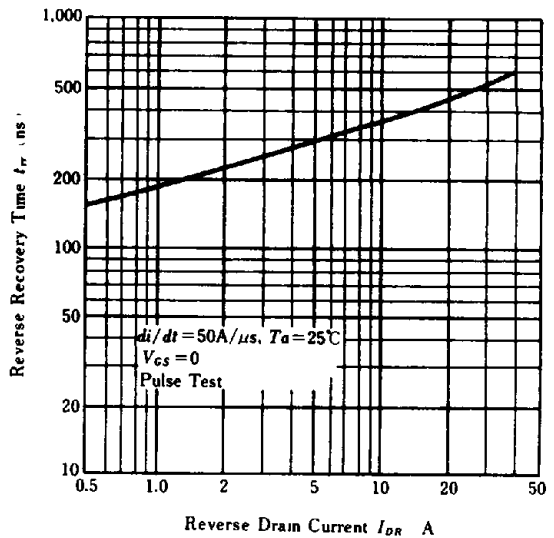

**TYPICAL CAPACITANCE VS. DRAIN-SOURCE VOLTAGE**

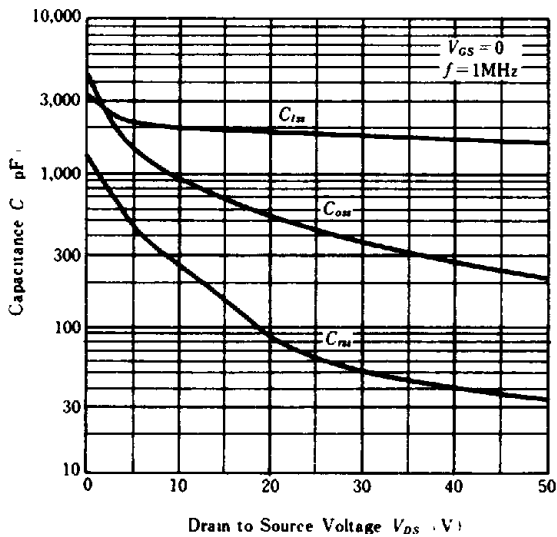

**DYNAMIC INPUT CHARACTERISTICS**

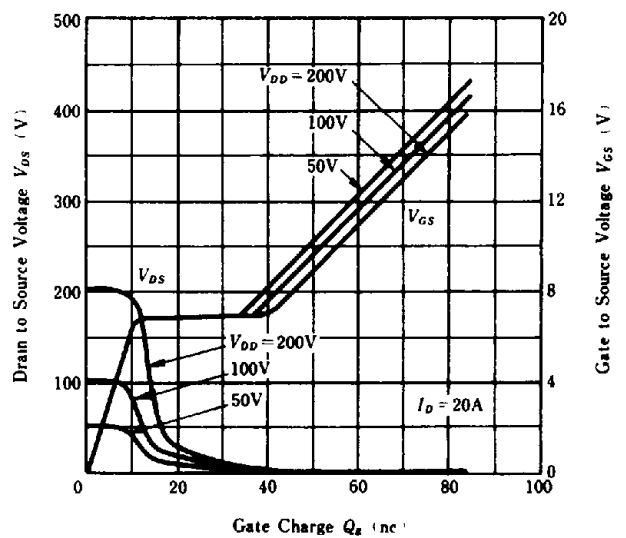

**SWITCHING CHARACTERISTICS**

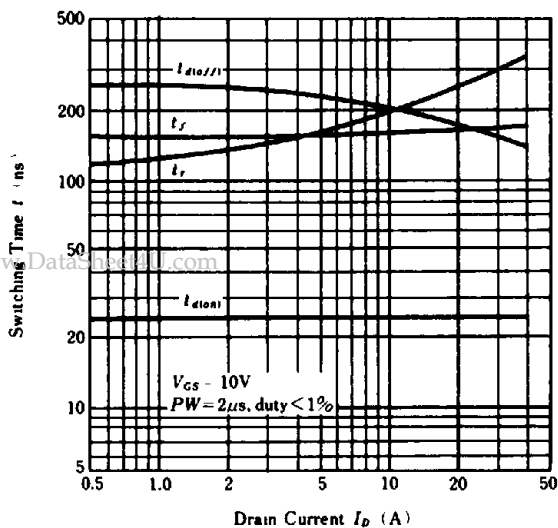

**REVERSE DRAIN CURRENT VS. SOURCE TO DRAIN VOLTAGE**

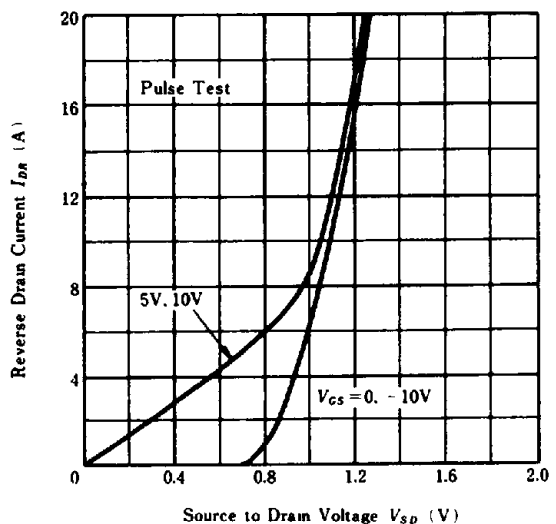

**NORMALIZED TRANSIENT THERMAL IMPEDANCE VS. PULSE WIDTH**

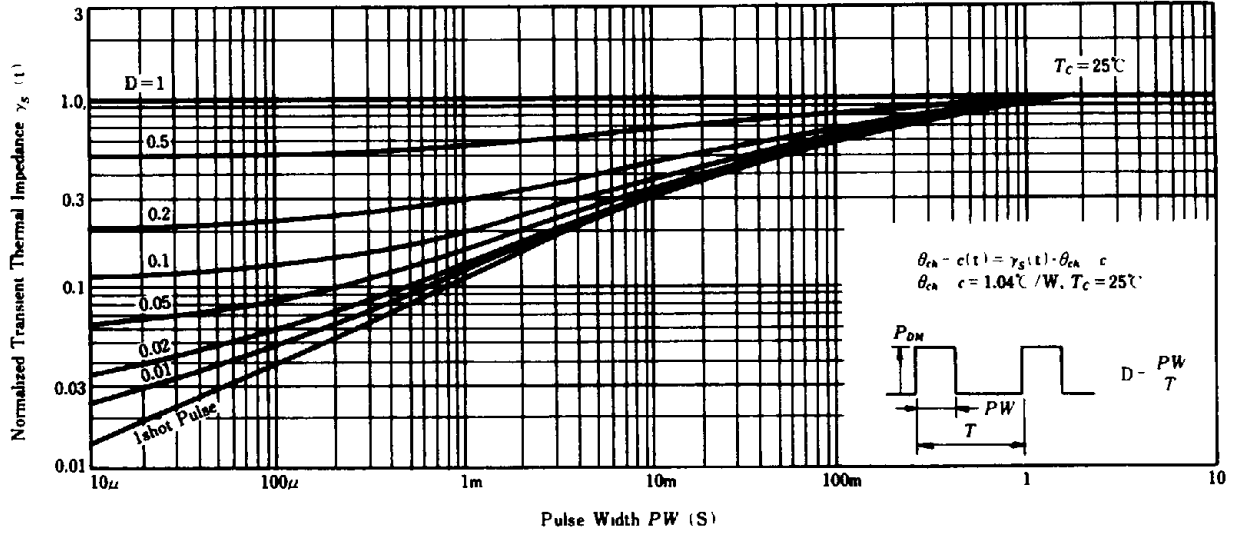

**SWITCHING TIME TEST CIRCUIT**

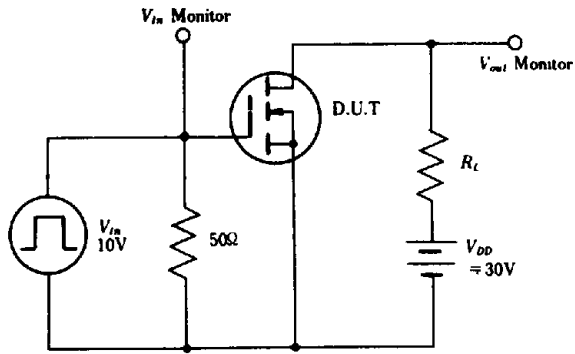

**WAVEFORMS**

