

2SK686

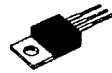

2052A

N-Channel MOS  
Silicon Field-Effect Transistor

T-39-11

# High Speed Power Switching Applications

**Features**

Low-on resistance, very high-speed switching, converters

**Absolute Maximum Ratings at Ta=25°C**

			unit
Drain to Source Voltage	V <sub>DS</sub>	60	V
Gate to Source Voltage	V <sub>GS</sub>	±20	V
Drain Current(DC)	I <sub>D</sub>	5	A
Peak Drain Current(Pulse)	I <sub>D peak</sub>	10	A
Allowable Power Dissipation	P <sub>D</sub>	40	W
Junction Temperature	T <sub>J</sub>	150	°C
Storage Temperature	T <sub>stg</sub>	-55 to +150	°C

T<sub>C</sub>=25°C

**Electrical Characteristics at Ta=25°C**

			min	typ	max	unit
D-S Breakdown Voltage	V <sub>DSS</sub>	I <sub>D</sub> =1mA, V <sub>GS</sub> =0	60			V
Drain Current	I <sub>DSS</sub>	V <sub>DS</sub> =60V, V <sub>GS</sub> =0			100	uA
G-S Leakage Current	I <sub>GSS</sub>	V <sub>GS</sub> =±20V, V <sub>DS</sub> =0			±100	nA
Cutoff Voltage	V <sub>GS(off)</sub>	V <sub>DS</sub> =10V, I <sub>D</sub> =1mA	1.5		4.0	V
Forward Transfer Admittance	Y <sub>fs</sub>	V <sub>DS</sub> =10V, I <sub>D</sub> =2.5A	1.4	2.0		S
Saturation Resistance	r <sub>DS(on)</sub>	I <sub>D</sub> =2.5A, V <sub>GS</sub> =10V		0.2	0.3	ohm
Input Capacitance	c <sub>iss</sub>	V <sub>DS</sub> =20V, f=1MHz		350		pF
Output Capacitance	c <sub>oss</sub>	V <sub>DS</sub> =20V, f=1MHz		230		pF
Reverse Transfer Capacitance	c <sub>rss</sub>	V <sub>DS</sub> =20V, f=1MHz		85		pF
Turn-on Time	t <sub>on</sub>	I <sub>D</sub> =2A, V <sub>GS</sub> =10V		35		ns
Turn-off Time	t <sub>off</sub>	I <sub>D</sub> =2A, V <sub>GS</sub> =10V		55		ns

Note: Be careful in handling the 2SK686 because it has no protect diode between gate and source.

**Switching Time Test Circuit**

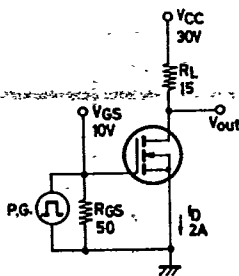

**Case Outline 2052A (unit:mm)**

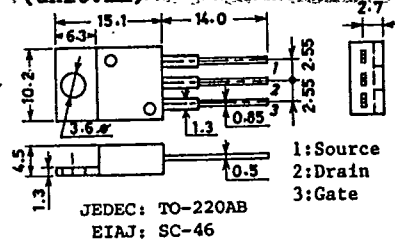

3267TA, TS No.2463-1/2

1783

2SK686

T-39-11

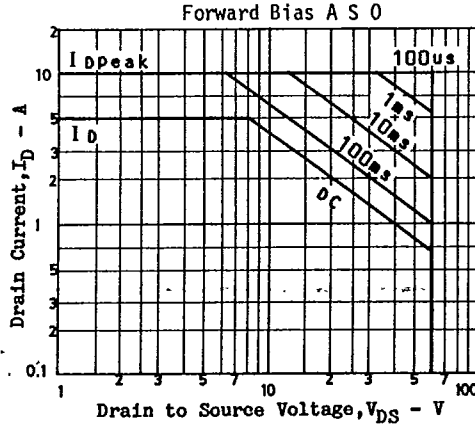
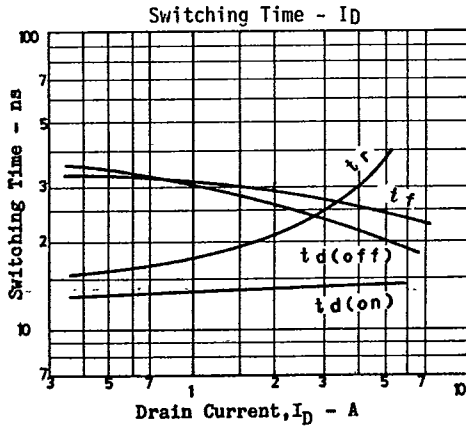
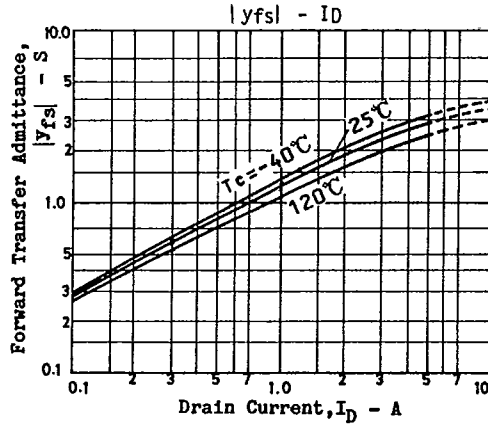
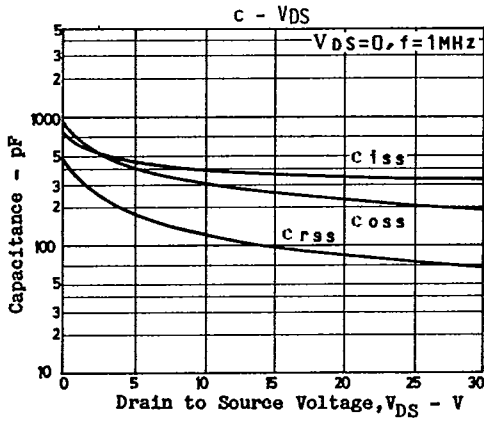
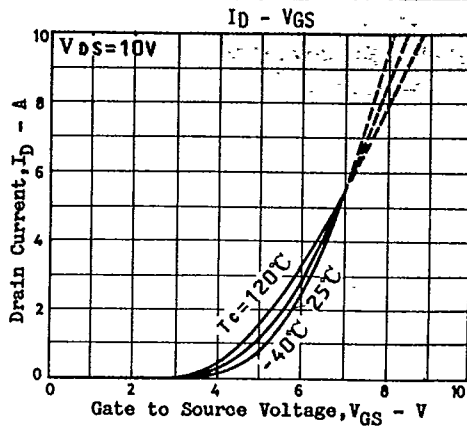
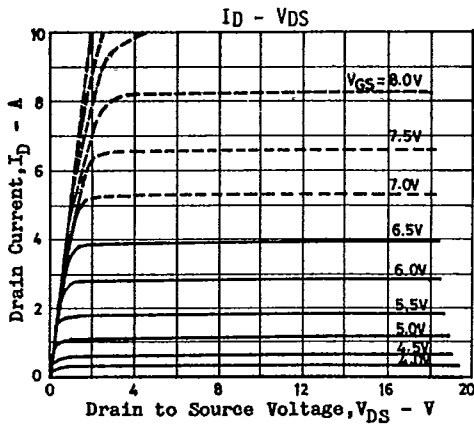

T-91-20

# CASE OUTLINES AND ATTACHMENTS

- All of Sanyo Transistor case outlines are illustrated below.
- All dimensions are in mm, and dimensions which are not followed by min. or max. are represented by typical values.
- No marking is indicated.

Case Outline-[2003A]  
unit:mm

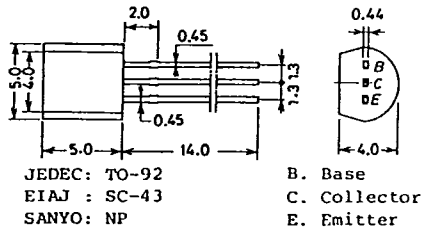

Case Outline-[2009A]  
unit:mm

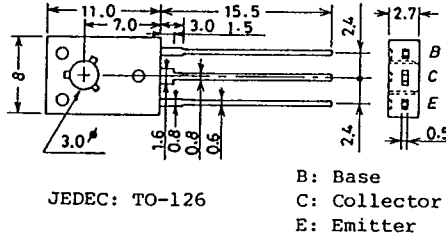

Case Outline-[2004A]  
unit:mm

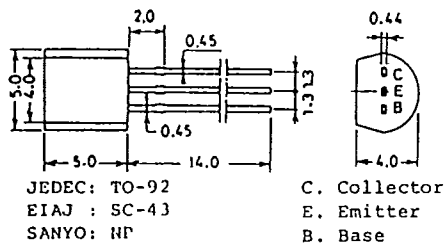

Case Outline-[2010A]  
unit:mm

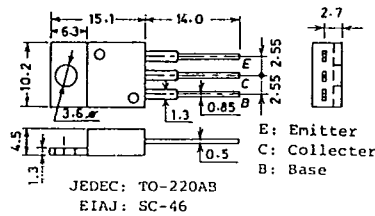

Case Outline-[2005A]  
unit:mm

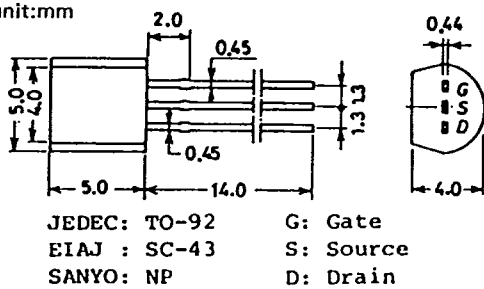

Case Outline-[2012]  
unit:mm

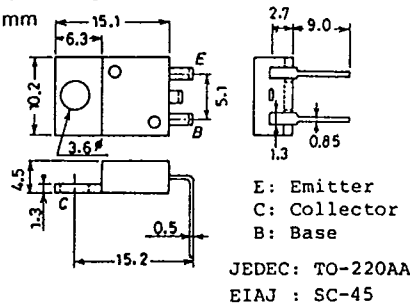

Case Outline-[2006A]  
unit:mm

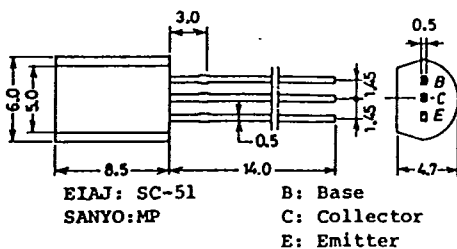

Case Outline-[2013]  
unit:mm

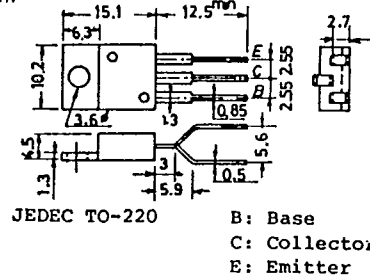

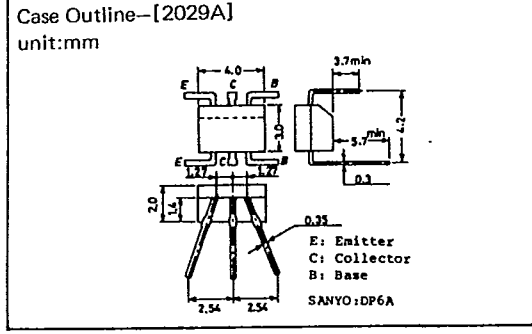
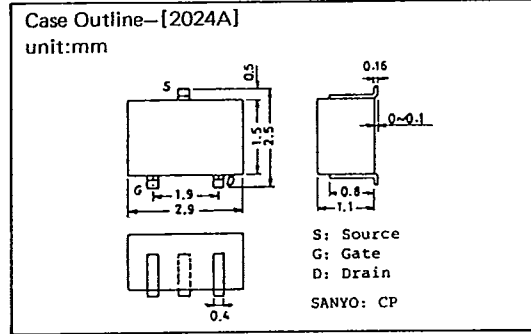
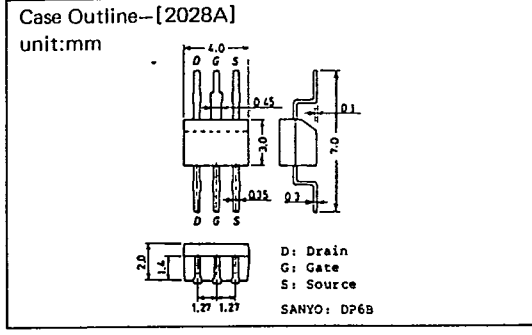
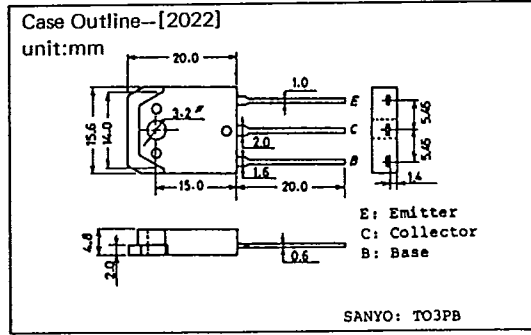
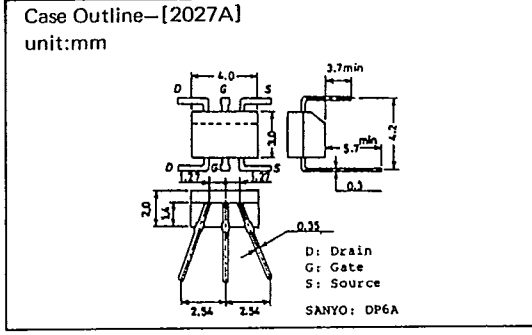
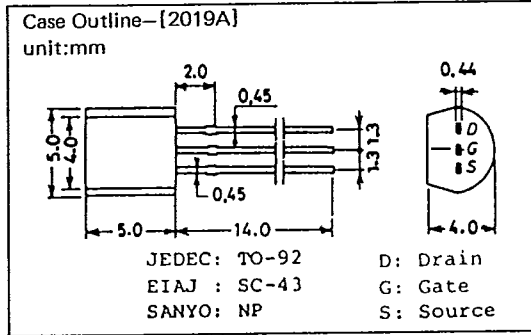
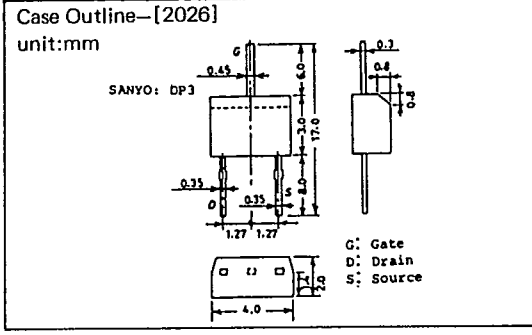
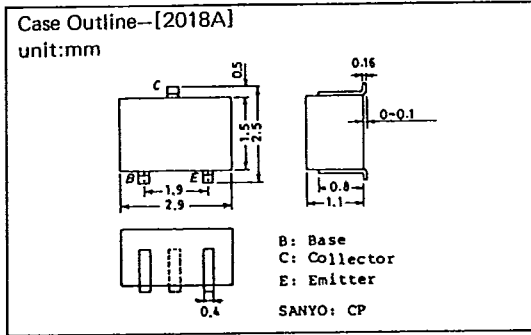
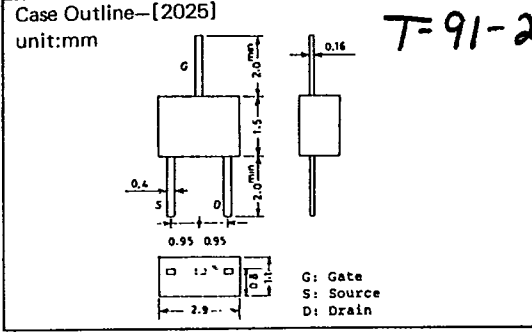
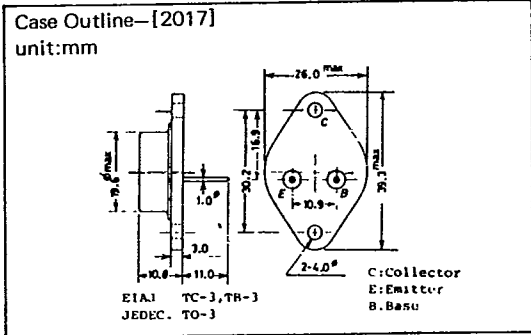



T-91-20

