

2.0A Bridge Rectifiers

Features

- Low reverse leakage current
- High forward surge current capability
- Ideal for printed circuit board
- High temperature soldering guaranteed:
260°C/10 seconds, 0.375" (9.5mm) lead length, 5 lbs (2.3kg) tension
- This series is UL recognized under component index, File number E194718
- RoHS compliant

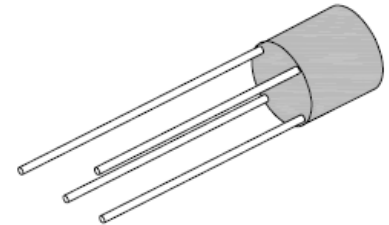

2W0M



Mechanical Data

Case:	Molded plastic body
Terminals:	Lead solderable per MIL-STD-202E, Method 208C
Polarity:	As marked on case
Weight:	0.05 ounce, 1.42 gram

Maximum Ratings And Electrical Characteristics (T_{amb}=25°C)

Symbols	Parameter	2W 005M	2W 01M	2W 02M	2W 04M	2W 06M	2W 08M	2W 10M	Unit	Conditions
V_{RRM}	Maximum Repetitive Peak Reverse Voltage	50	100	200	400	600	800	1000	V	
V_{RMS}	Maximum RMS Voltage	35	70	140	280	420	560	700	V	
V_{DC}	Maximum DC Blocking Voltage	50	100	200	400	600	800	1000	V	
I_{F(AV)}	Maximum Average Forward Rectified Current	2.0							A	TA=50°C
I_{FSM}	Peak Forward Surge Current	50							A	8.3ms single half sine-wave superimposed on rated load (JEDEC Method)
V_F	Maximum Instantaneous Forward Voltage Drop per leg	1.1							V	I _F =2.0A
I_R	Maximum DC Reverse Current at Rated DC Blocking Voltage per leg	5.0							µA	TA=25°C
		500								TA=100°C
I_t	Rating for Fusing (1ms<t<8.3ms)	10							A ² S	

2.0A Bridge Rectifiers

2W005M - 2W10M

Symbols	Parameter	2W 005M	2W 01M	2W 02M	2W 04M	2W 06M	2W 08M	2W 10M	Unit	Conditions
C_J	Typical Junction Capacitance	15							pF	V _R =4V, f=1MHz
R_{θJA}	Typical Thermal Resistance per leg	40							°C/W	Note 1
T_J	Operating Temperature Range	-55 to +125							V	
T_{STG}	Storage Temperature Range	-55 to +150							°C	

- Note:** 1. Unit mounted on P.C. board with 0.22 x 0.22" (5.5 x 5.5mm) copper pads, .375" (9.5mm) lead length.
 2. Single Phase, half wave, 60Hz, resistive or inductive load.
 For capacitive load, derate current by 20%.

Rating and characteristic curves

Fig.1- Derating Curve Output Rectified Current

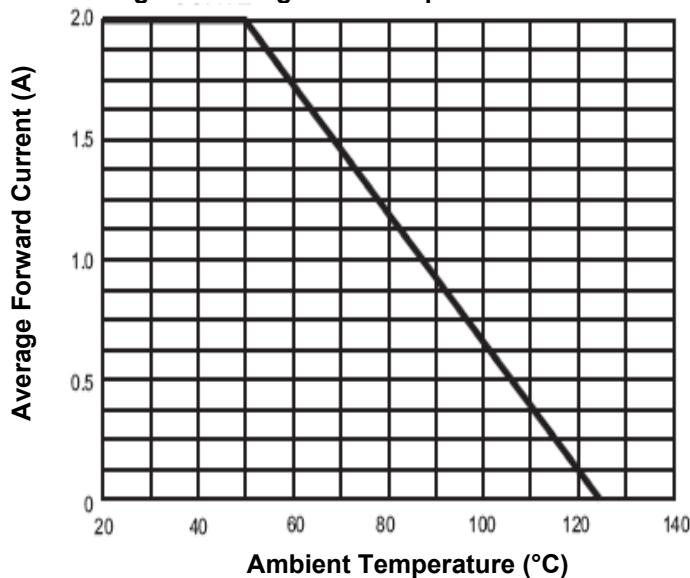
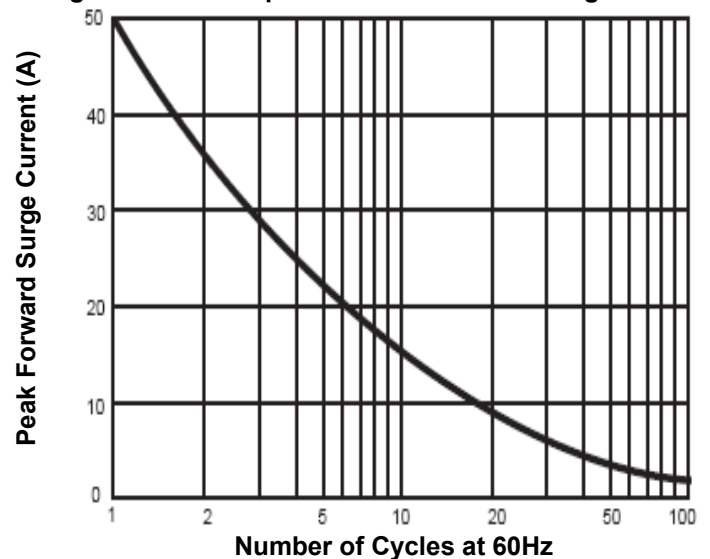

Fig.2-Max Non-Repetitive Peak Forward Surge Current



2.0A Bridge Rectifiers

2W005M - 2W10M

Fig.3- Typical Instantaneous Forward Characteristics, per leg

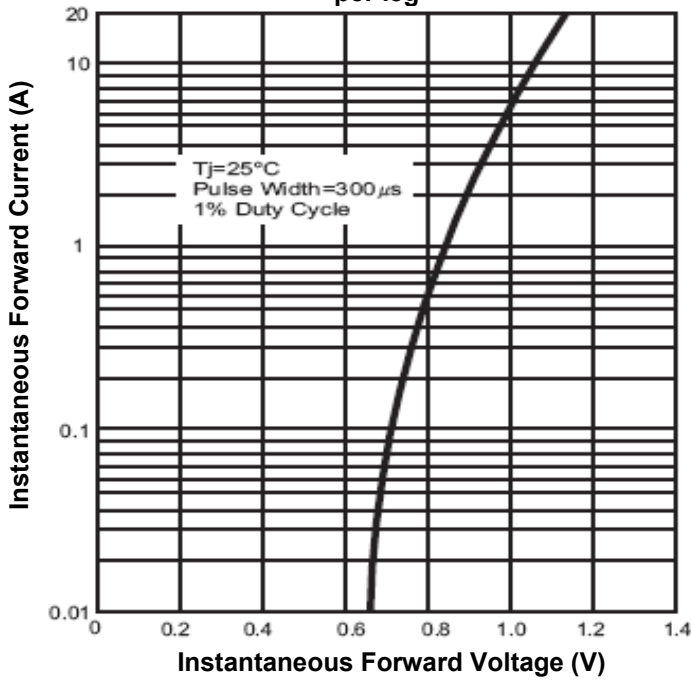

Fig.4-Typical Reverse Leakage Characteristics per leg

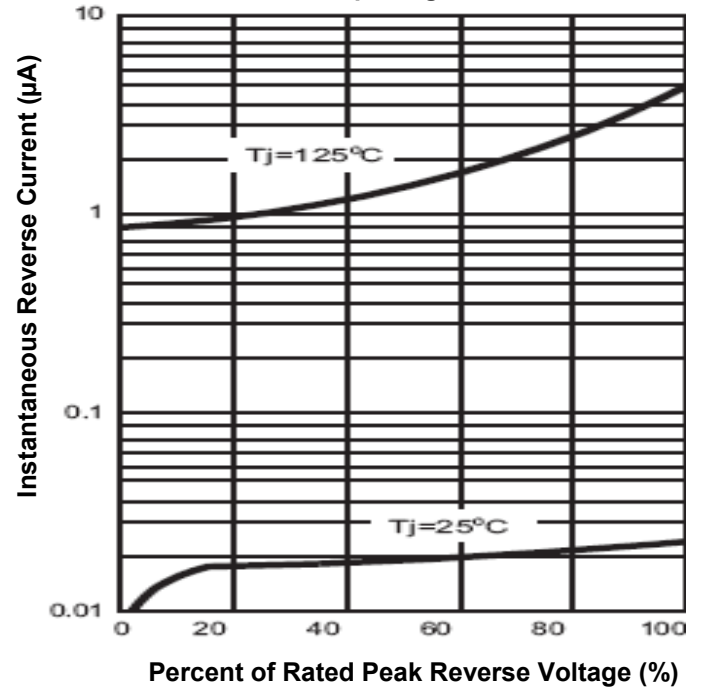
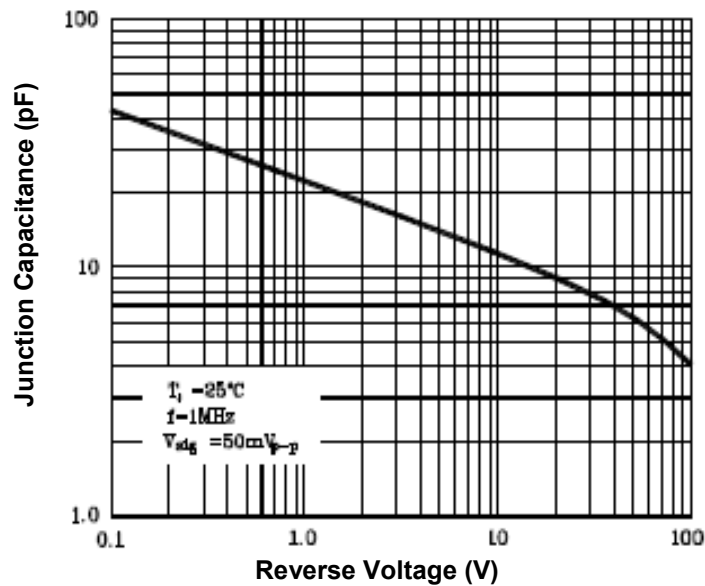

Fig.5-Typical Junction Capacitance per leg



2.0A Bridge Rectifiers

2W005M - 2W10M

Dimensions in inch (mm)

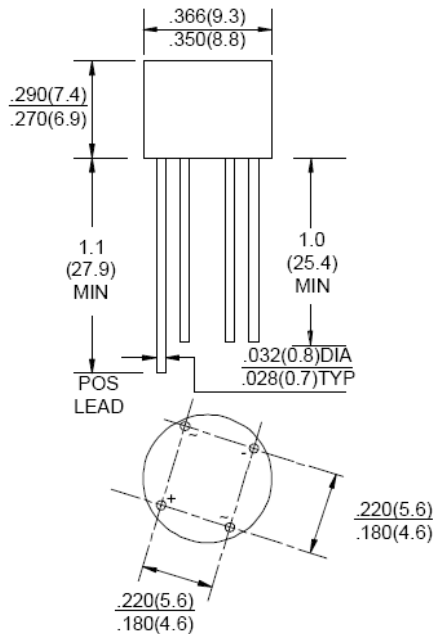

2W005M

How to contact us

US HEADQUARTERS

28040 WEST HARRISON PARKWAY, VALENCIA, CA 91355-4162

Tel: (800) TAITRON (800) 824-8766 (661) 257-6060

Fax: (800) TAITFAX (800) 824-8329 (661) 257-6415

Email: taitron@taitroncomponents.com

Http://www.taitroncomponents.com

TAITRON COMPONENTS MEXICO, S.A. DE C.V.

BOULEVARD CENTRAL 5000 INTERIOR 5 PARQUE INDUSTRIAL ATITALAQUIA, HIDALGO C.P.

42970 MEXICO

Tel: +52-55-5560-1519

Fax: +52-55-5560-2190

TAITRON COMPONENTS INCORPORATED REPRESENTAÇÕES DO BRASIL LTDA

RUA DOMINGOS DE MORAIS, 2777, 2.ANDAR, SALA 24 SAÚDE - SÃO PAULO-SP 04035-001 BRAZIL

Tel: +55-11-5574-7949

Fax: +55-11-5572-0052

TAITRON COMPONENTS INCORPORATED, SHANGHAI REPRESENTATIVE OFFICE

METROBANK PLAZA, 1160 WEST YAN' AN ROAD, SUITE 1503, SHANGHAI, 200052, CHINA

Tel: +86-21-5424-9942

Fax: +86-21-5424-9931

TAITRON
components incorporated

Rev. A/AH 2008-05-22