

# DIODE Type : 30PDA10

3A 100V Tj =150 °C

OUTLINE DRAWING

## FEATURES

- \* Low Forward Voltage drop
- \* Low Reverse Leakage Current
- \* High Surge Capability

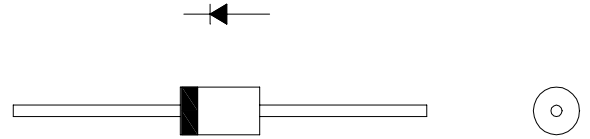

## Maximum Ratings

Approx Net Weight:1.24g

Rating	Symbol	30PDA10		Unit	
Repetitive Peak Reverse Voltage	$V_{RRM}$	100		V	
Average Rectified Output Current	$I_O$	50Hz Half Sine Wave Resistive Load	Ta=31°C *1	1.6	A
			Tl=124°C (Tl: Lead Temperature)	3.0	
RMS Forward Current	$I_{F(RMS)}$			4.71	A
Surge Forward Current	$I_{FSM}$	50Hz Half Sine Wave,1cycle, Non-repetitive		100	A
Operating JunctionTemperature Range	$T_{jw}$	- 40 to + 150			°C
Storage Temperature Range	$T_{stg}$	- 40 to + 150			°C

## Electrical • Thermal Characteristics

Characteristics	Symbol	Conditions	Min.	Typ.	Max.	Unit
Peak Reverse Current	$I_{RM}$	Tj= 25°C, $V_{RM}= V_{RRM}$	-	-	10	μA
Peak Forward Voltage	$V_{FM}$	Tj= 25°C, $I_{FM}= 3.0A$	-	-	1.0	V
Thermal Resistance	Rth(j-a)	Junction to Ambient *1	-	-	80	°C/W
	Rth(j-l)	Junction to Lead	-	-	8	

\*1: Without Fin or P.C. Board mounted

30PDA OUTLINE DRAWING (Dimensions in mm)

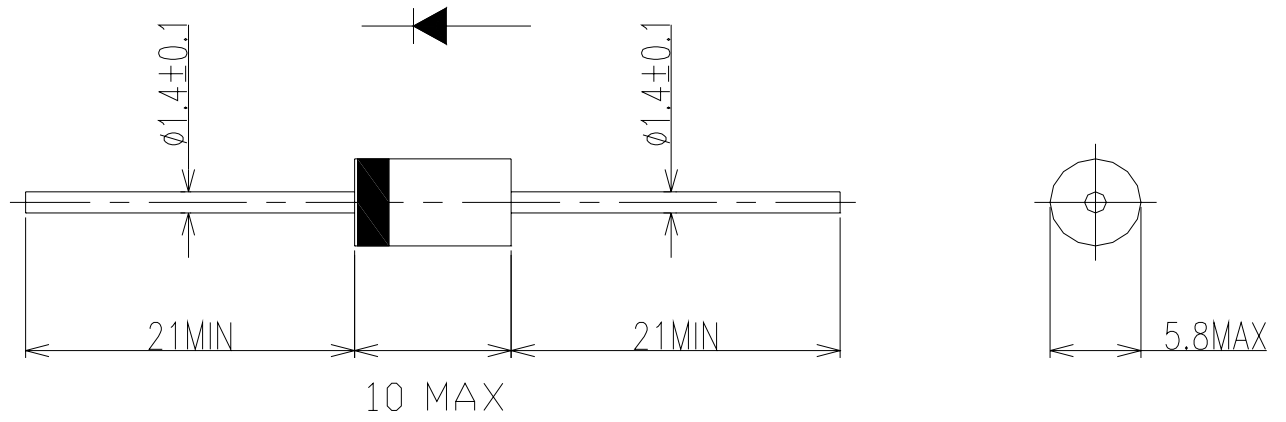

### FORWARD CURRENT VS. VOLTAGE

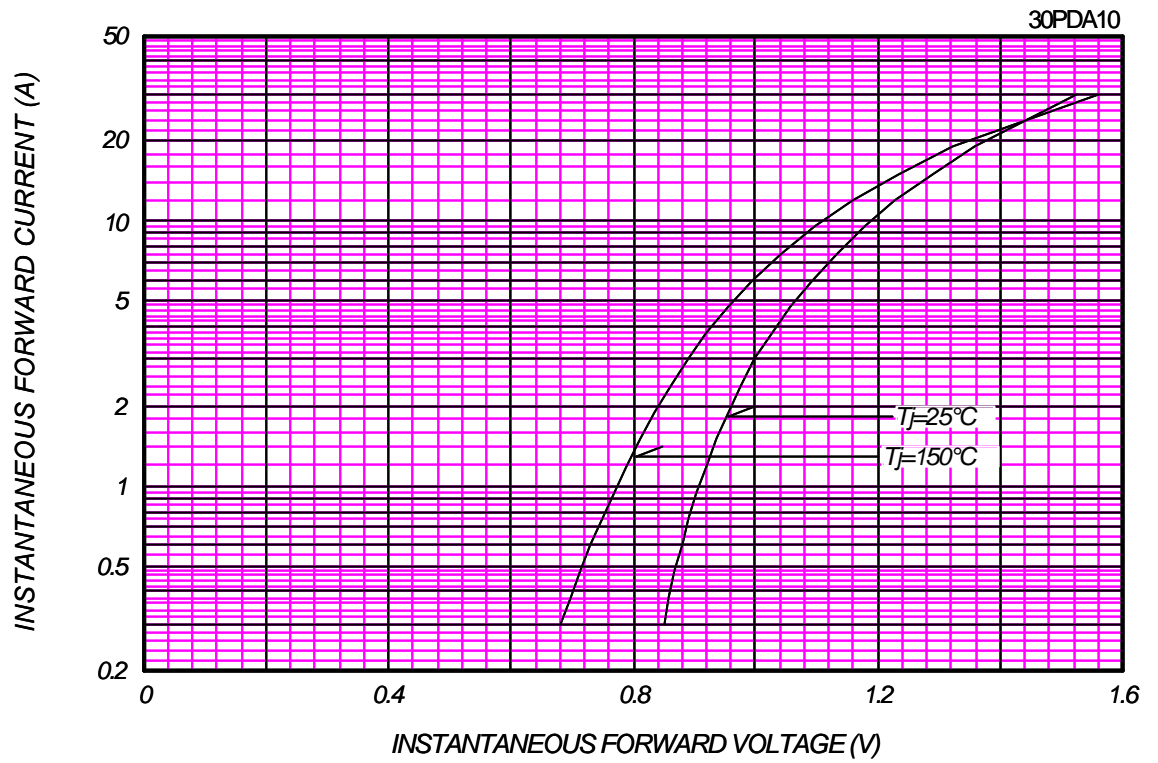

### AVERAGE FORWARD POWER DISSIPATION

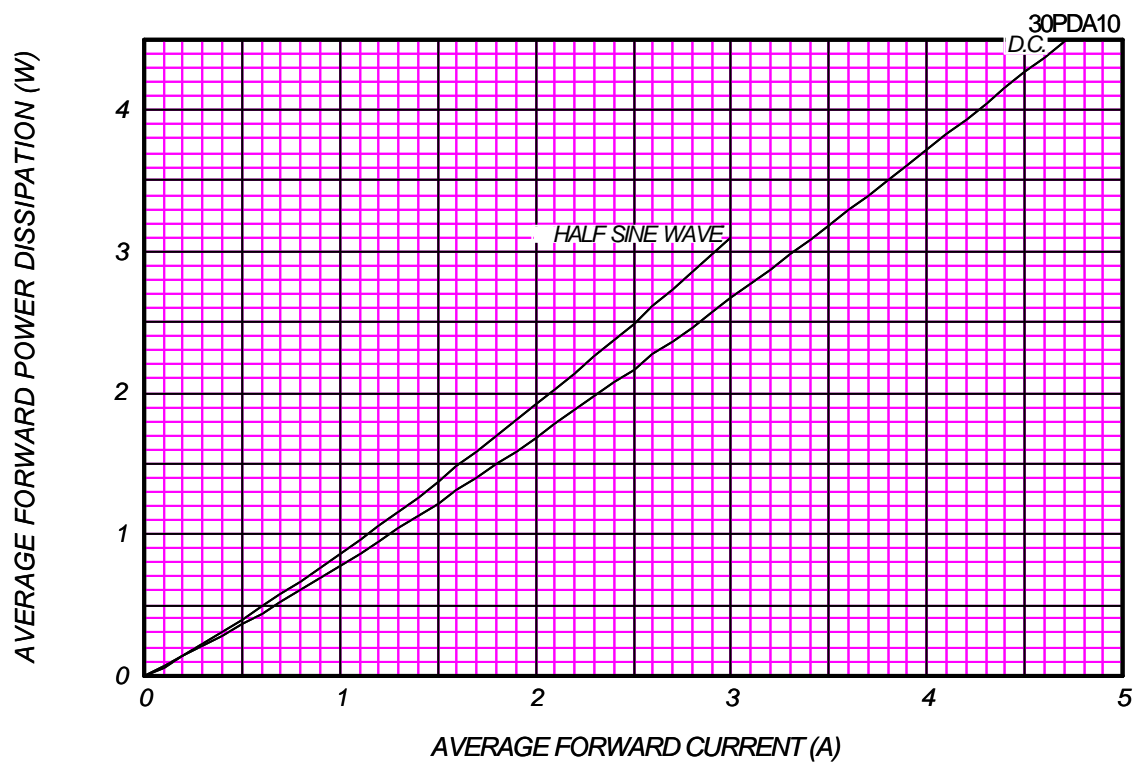

### AVERAGE FORWARD CURRENT VS. AMBIENT TEMPERATURE

Without Fin or P.C. Board

30PDA10

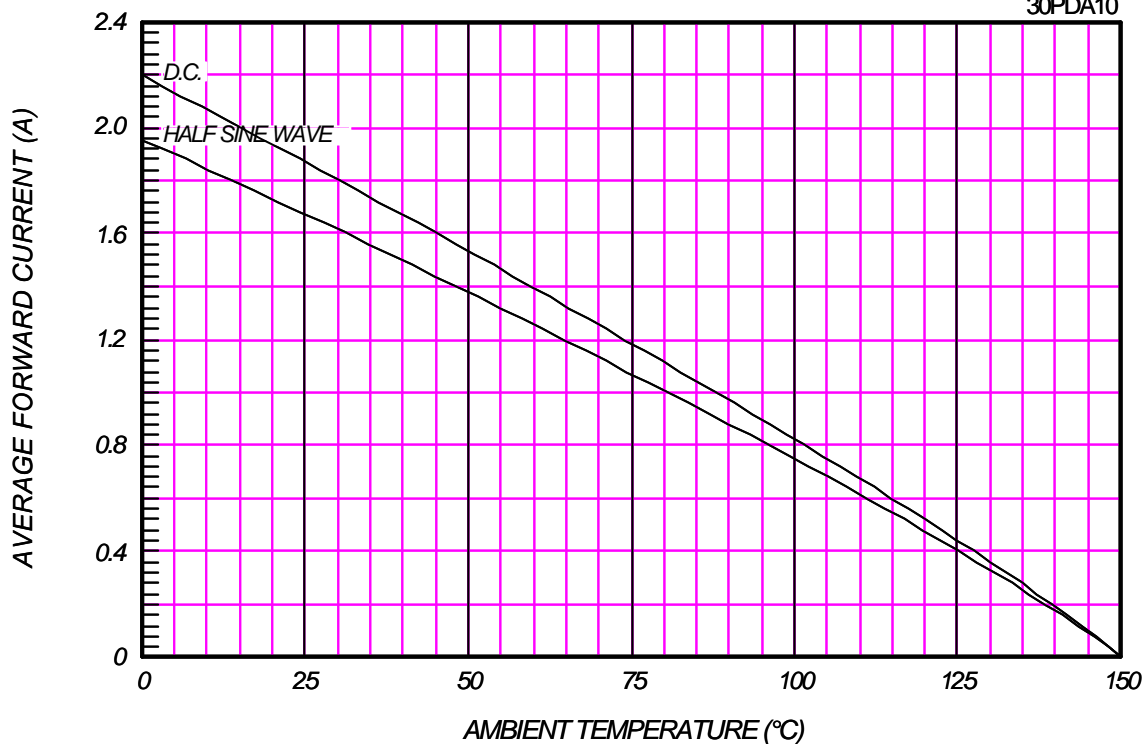

### AVERAGE FORWARD CURRENT VS. LEAD TEMPERATURE

30PDA10

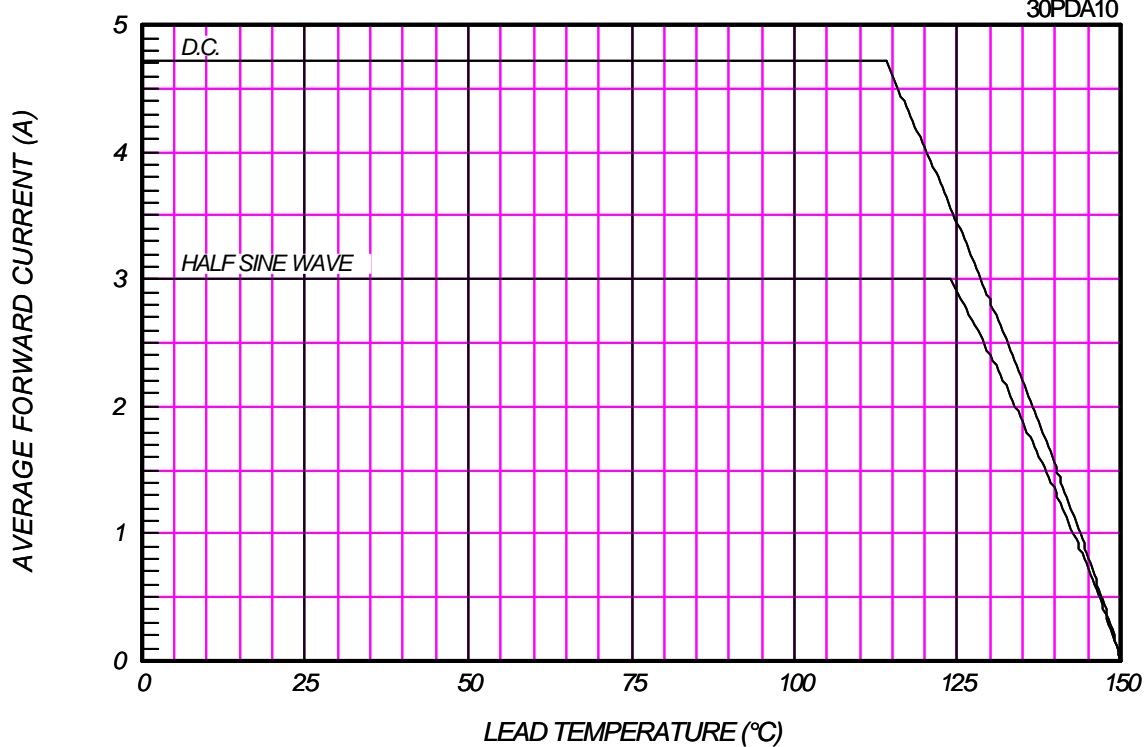

# SURGE CURRENT RATINGS

f=50Hz, Half Sine Wave, Non-Repetitive, No Load

30PDA10

