

FFH30US30DN

30A, 300V Stealth™ Diode

General Description

The FFH30US30DN is a Stealth™ diode optimized for low loss performance in output rectification. The Stealth™ family exhibits low reverse recovery current ($I_{RM(REC)}$), low V_F and soft recovery under typical operating conditions.

This device is intended for use as an output rectification diode in Telecom power supplies and other power switching applications. Lower V_F and $I_{RM(REC)}$ reduces diode losses.

Formerly developmental type TA49449.

Features

- Soft Recovery $t_b / t_a > 0.45$
- Fast Recovery $t_{rr} < 50ns$
- High Operating Temperature 175°C
- Reverse Voltage 300V
- Avalanche Energy Rating20mJ

Applications

- Switch Mode Power Supplies
- Power Factor Correction
- Uninterruptable Power Supplies
- Motor Drives
- Welders

Package

JEDEC STYLE 3 LEAD TO-247

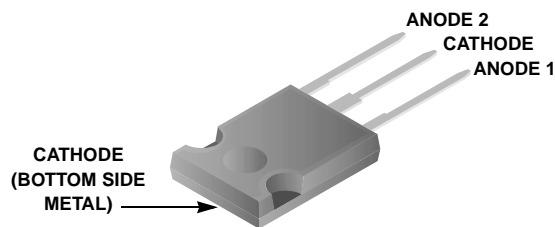

Symbol

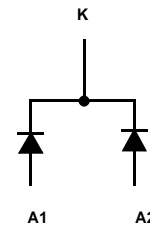

Device Maximum Ratings (per leg) $T_C = 25^\circ\text{C}$ unless otherwise noted

| Symbol | Parameter | Ratings | Units |
|----------------|---|------------|----------|
| V_{RRM} | Repetitive Peak Reverse Voltage | 300 | V |
| V_{RWM} | Working Peak Reverse Voltage | 300 | V |
| V_R | DC Blocking Voltage | 300 | V |
| $I_{F(AV)}$ | Average Rectified Forward Current ($T_C = 160^\circ\text{C}$) Total Device Current (Both Legs) | 30 60 | A A |
| I_{FRM} | Repetitive Peak Surge Current (20kHz Square Wave) | 70 | A |
| I_{FSM} | Nonrepetitive Peak Surge Current (Halfwave 1 Phase 60Hz) | 325 | A |
| P_D | Power Dissipation | 230 | W |
| E_{AVL} | Avalanche Energy (1A, 40mH) | 20 | mJ |
| T_J, T_{STG} | Operating and Storage Temperature Range | -55 to 175 | °C |
| T_L | Maximum Temperature for Soldering | | |
| T_{PKG} | Leads at 0.063in (1.6mm) from Case for 10s Package Body for 10s, See Application Note AN-7528 | 300 260 | °C °C |

CAUTION: Stresses above those listed in "Device Maximum Ratings" may cause permanent damage to the device. This is a stress only rating and operation of the device at these or any other conditions above those indicated in the operational sections of this specification is not implied.

Package Marking and Ordering Information

| Device Marking | Device | Package | Tape Width | Quantity |
|----------------|-------------|---------|------------|----------|
| 30US30DN | FFH30US30DN | TO-247 | N/A | 30 |

Electrical Characteristics (per leg) $T_C = 25^\circ\text{C}$ unless otherwise noted

| Symbol | Parameter | Test Conditions | Min | Typ | Max | Units |
|--------|-----------|-----------------|-----|-----|-----|-------|
|--------|-----------|-----------------|-----|-----|-----|-------|

Off State Characteristics

| | | | | | | | |
|-------|-------------------------------|---------------------|---------------------------|---|---|-----|---------------|
| I_R | Instantaneous Reverse Current | $V_R = 300\text{V}$ | $T_C = 25^\circ\text{C}$ | - | - | 100 | μA |
| | | | $T_C = 125^\circ\text{C}$ | - | - | 1 | mA |

On State Characteristics

| | | | | | | | |
|-------|-------------------------------|--------------------|---------------------------|---|------|------|---|
| V_F | Instantaneous Forward Voltage | $I_F = 30\text{A}$ | $T_C = 25^\circ\text{C}$ | - | 0.93 | 1.0 | V |
| | | | $T_C = 125^\circ\text{C}$ | - | 0.8 | 0.87 | V |

Dynamic Characteristics

| | | | | | | |
|-------|----------------------|-------------------------------------|---|-----|---|-------------|
| C_J | Junction Capacitance | $V_R = 10\text{V}, I_F = 0\text{A}$ | - | 410 | - | pF |
|-------|----------------------|-------------------------------------|---|-----|---|-------------|

Switching Characteristics

| | | | | | | |
|---------------|----------------------------------|--|----|------|----|----|
| t_{rr} | Reverse Recovery Time | $I_F = 1\text{A}, di_F/dt = 100\text{A}/\mu\text{s}, V_R = 15\text{V}$ | - | 29 | 50 | ns |
| | | $I_F = 30\text{A}, di_F/dt = 100\text{A}/\mu\text{s}, V_R = 15\text{V}$ | - | 32 | 55 | ns |
| t_{rr} | Reverse Recovery Time | $I_F = 30\text{A}, di_F/dt = 200\text{A}/\mu\text{s}, V_R = 195\text{V}, T_C = 25^\circ\text{C}$ | -4 | 6- | - | ns |
| $I_{RM(REC)}$ | Maximum Reverse Recovery Current | | - | 5.3 | - | A |
| Q_{RR} | Reverse Recovered Charge | | - | 140 | - | nC |
| t_{rr} | Reverse Recovery Time | | -7 | 7- | - | ns |
| S | Softness Factor (t_b/t_a) | $I_F = 30\text{A}, di_F/dt = 200\text{A}/\mu\text{s}, V_R = 195\text{V}, T_C = 125^\circ\text{C}$ | - | 0.45 | - | - |
| $I_{RM(REC)}$ | Maximum Reverse Recovery Current | | - | 9 | - | A |
| Q_{RR} | Reverse Recovered Charge | | - | 400 | - | nC |
| t_{rr} | Reverse Recovery Time | | -5 | 4- | - | ns |
| S | Softness Factor (t_b/t_a) | $I_F = 30\text{A}, di_F/dt = 1000\text{A}/\mu\text{s}, V_R = 195\text{V}, T_C = 125^\circ\text{C}$ | - | 0.49 | - | - |
| $I_{RM(REC)}$ | Maximum Reverse Recovery Current | | - | 32 | - | A |
| Q_{RR} | Reverse Recovered Charge | | - | 930 | - | nC |

Thermal Characteristics

| | | | | | | |
|-----------------|--|--------|---|---|------|---------------------------|
| $R_{\theta JC}$ | Thermal Resistance Junction to Case | TO-247 | - | - | 0.65 | $^\circ\text{C}/\text{W}$ |
| $R_{\theta JA}$ | Thermal Resistance Junction to Ambient | TO-247 | - | - | 30 | $^\circ\text{C}/\text{W}$ |

Typical Performance Curves (per leg)

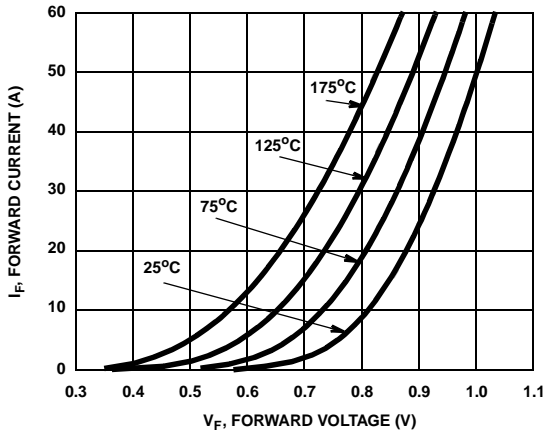

Figure 1. Forward Current vs Forward Voltage

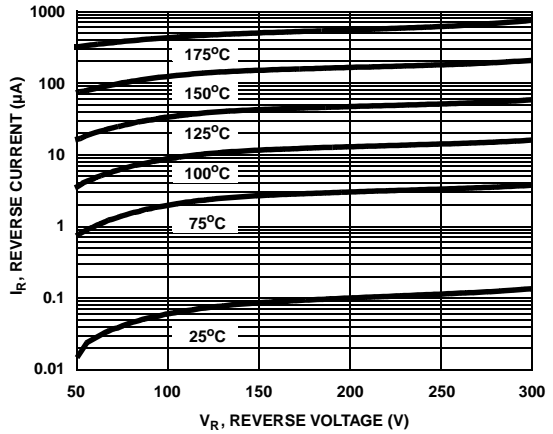

Figure 2. Reverse Current vs Reverse Voltage

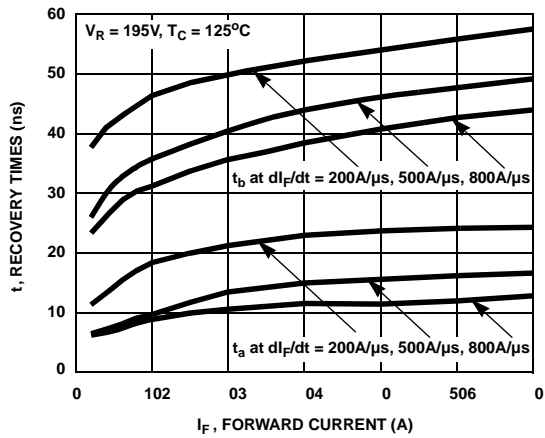

Figure 3. t_a and t_b Curves vs Forward Current

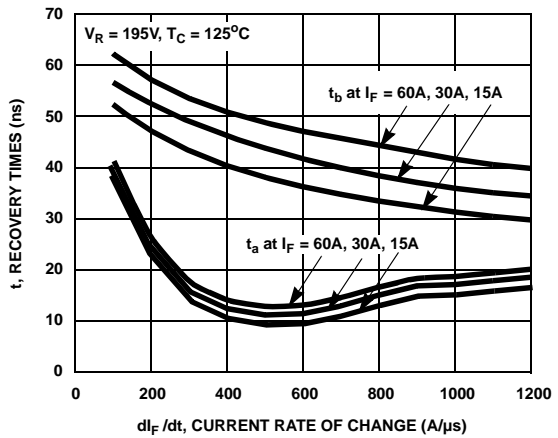

Figure 4. t_a and t_b Curves vs di_F/dt

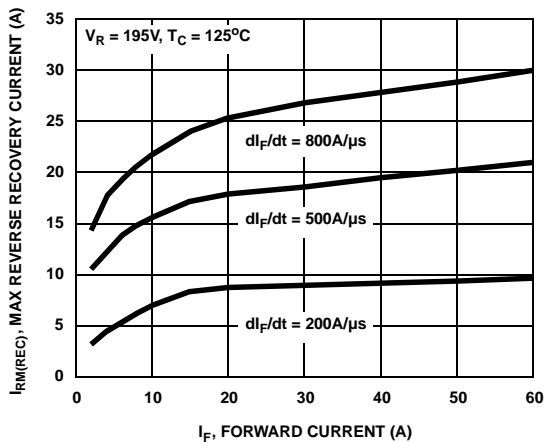

Figure 5. Maximum Reverse Recovery Current vs Forward Current

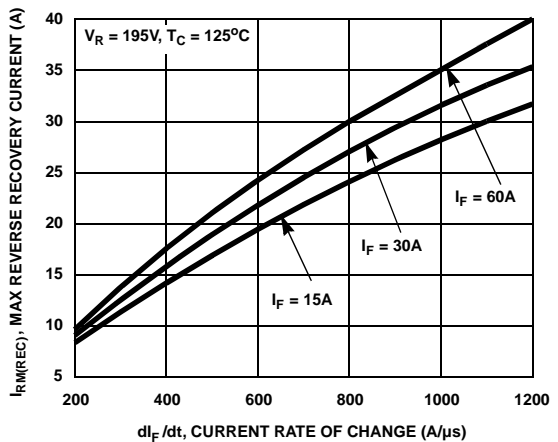

Figure 6. Maximum Reverse Recovery Current vs di_F/dt

Typical Performance Curves (per leg) (Continued)

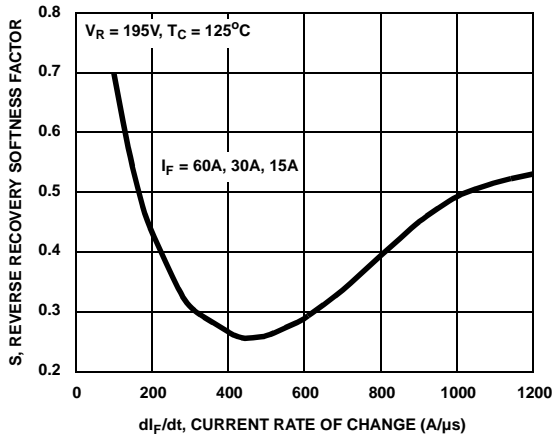

Figure 7. Reverse Recovery Softness Factor vs dI_F/dt

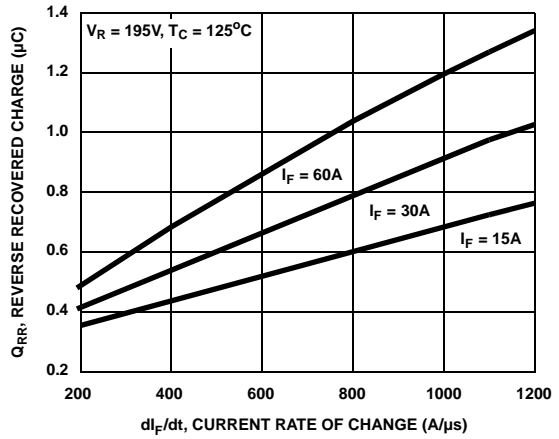

Figure 8. Reverse Recovery Charge vs dI_F/dt

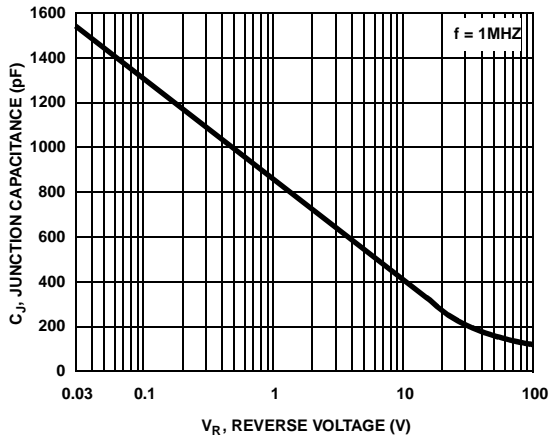

Figure 9. Junction Capacitance vs Reverse Voltage

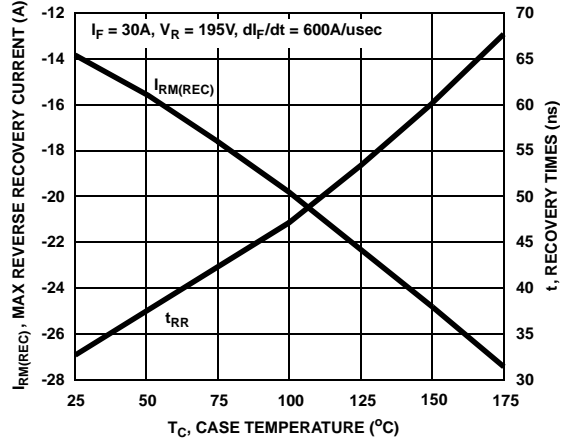

Figure 10. Maximum Reverse Recovery Current and t_{rr} vs Case Temperature

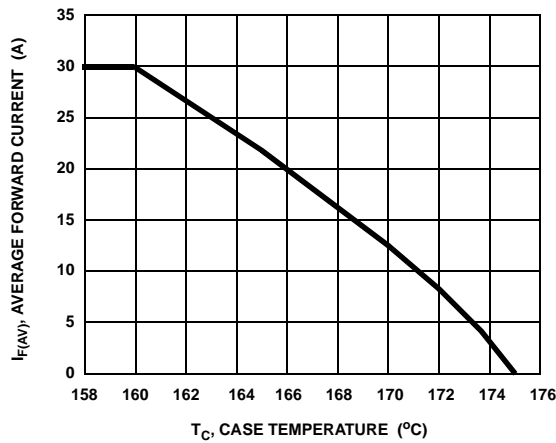

Figure 11. DC CURRENT DERATING CURVE

Typical Performance Curves (per leg) (Continued)

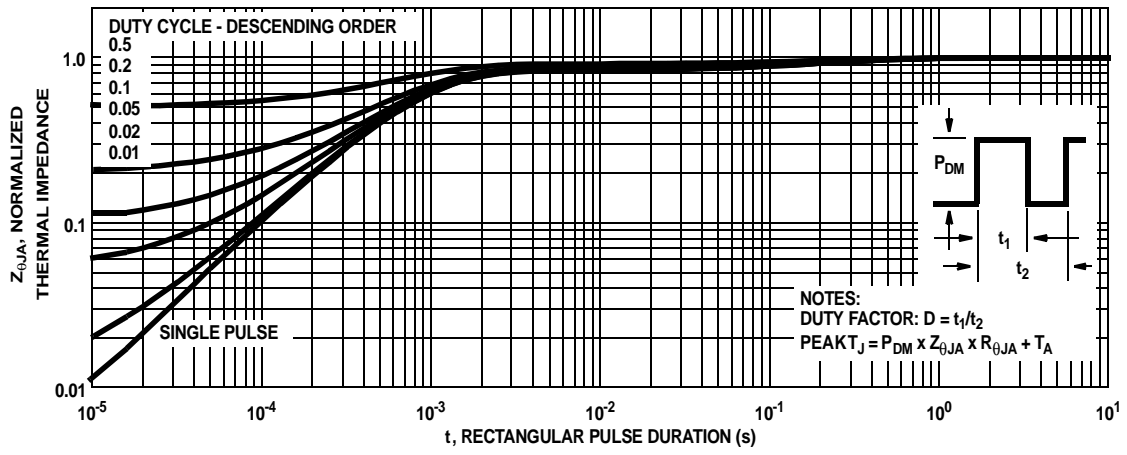

Figure 12. Normalized Maximum Transient Thermal Impedance

Test Circuit and Waveforms

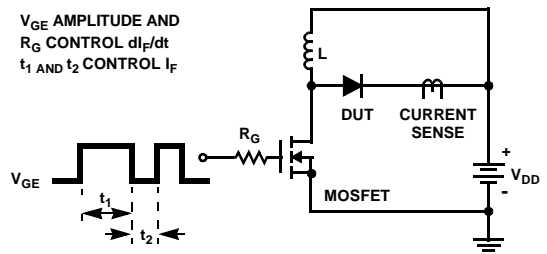

Figure 13. t_{rr} Test Circuit

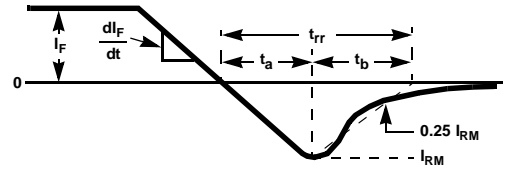
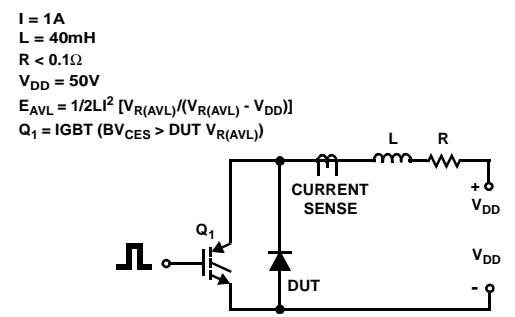

Figure 14. t_{rr} Waveforms and Definitions



$I = 1A$
 $L = 40mH$
 $R < 0.1\Omega$
 $V_{DD} = 50V$
 $E_{AVL} = 1/2LI^2 [V_{R(AVL)}/(V_{R(AVL)} - V_{DD})]$
 $Q_1 = IGBT (BV_{CES} > DUT V_{R(AVL)})$

Figure 15. Avalanche Energy Test Circuit

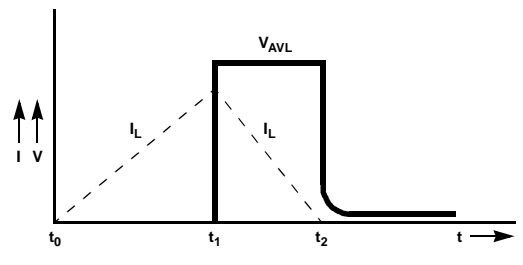

Figure 16. Avalanche Current and Voltage Waveforms

TRADEMARKS

The following are registered and unregistered trademarks Fairchild Semiconductor owns or is authorized to use and is not intended to be an exhaustive list of all such trademarks.

| | | | | |
|--------------------------------------|---------------------|--------------------|---------------------|-----------------|
| ACEx™ | FACT™ | ImpliedDisconnect™ | PACMAN™ | SPM™ |
| ActiveArray™ | FACT Quiet Series™ | ISOPLANAR™ | POP™ | Stealth™ |
| Bottomless™ | FAST® | LittleFET™ | Power247™ | SuperSOT™_3 |
| CoolFET™ | FASTr™ | MicroFET™ | PowerTrench® | SuperSOT™_6 |
| CROSSVOLT™ | FRFET™ | MicroPak™ | QFET™ | SuperSOT™_8 |
| DOME™ | GlobalOptoisolator™ | MICROWIRE™ | QS™ | SyncFET™ |
| EcoSPARK™ | GTO™ | MSX™ | QT Optoelectronics™ | TinyLogic® |
| E ² CMOS™ | HiSeC™ | MSXPro™ | Quiet Series™ | TruTranslation™ |
| EnSigna™ | µC™ | OCX™ | RapidConfigure™ | UHC™ |
| Across the board. Around the world.™ | | OCXPro™ | RapidConnect™ | UltraFET® |
| The Power Franchise™ | | OPTOLOGIC® | SILENTSWITCHER® | VCX™ |
| ProgrammableActive Droop™ | | OPTOPLANAR™ | SMART START™ | |

DISCLAIMER

FAIRCHILD SEMICONDUCTOR RESERVES THE RIGHT TO MAKE CHANGES WITHOUT FURTHER NOTICE TO ANY PRODUCTS HEREIN TO IMPROVE RELIABILITY, FUNCTION OR DESIGN. FAIRCHILD DOES NOT ASSUME ANY LIABILITY ARISING OUT OF THE APPLICATION OR USE OF ANY PRODUCT OR CIRCUIT DESCRIBED HEREIN; NEITHER DOES IT CONVEY ANY LICENSE UNDER ITS PATENT RIGHTS, NOR THE RIGHTS OF OTHERS.

LIFE SUPPORT POLICY

FAIRCHILD'S PRODUCTS ARE NOT AUTHORIZED FOR USE AS CRITICAL COMPONENTS IN LIFE SUPPORT DEVICES OR SYSTEMS WITHOUT THE EXPRESS WRITTEN APPROVAL OF FAIRCHILD SEMICONDUCTOR CORPORATION.

As used herein:

1. Life support devices or systems are devices or systems which, (a) are intended for surgical implant into the body, or (b) support or sustain life, or (c) whose failure to perform when properly used in accordance with instructions for use provided in the labeling, can be reasonably expected to result in significant injury to the user.
2. A critical component is any component of a life support device or system whose failure to perform can be reasonably expected to cause the failure of the life support device or system, or to affect its safety or effectiveness.

PRODUCT STATUS DEFINITIONS

Definition of Terms

| Datasheet Identification | Product Status | Definition |
|--------------------------|------------------------|---|
| Advance Information | Formative or In Design | This datasheet contains the design specifications for product development. Specifications may change in any manner without notice. |
| Preliminary | First Production | This datasheet contains preliminary data, and supplementary data will be published at a later date. Fairchild Semiconductor reserves the right to make changes at any time without notice in order to improve design. |
| No Identification Needed | Full Production | This datasheet contains final specifications. Fairchild Semiconductor reserves the right to make changes at any time without notice in order to improve design. |
| Obsolete | Not In Production | This datasheet contains specifications on a product that has been discontinued by Fairchild semiconductor. The datasheet is printed for reference information only. |