



Technical Data Sheet

HIGH POWER LED

31-01USOC

Benefits

- . Fewer LEDs Required
- . Lowers Lighting System Cost
- . Viewing angle 50°

Features

- . High Flux Output.
- . Designed for High Current Operation.
- . Low Thermal Resistance.
- . Low Profile.
- . Packaged in Tubes for Use with Automatic Insertion Equipment.
- . Pb free.

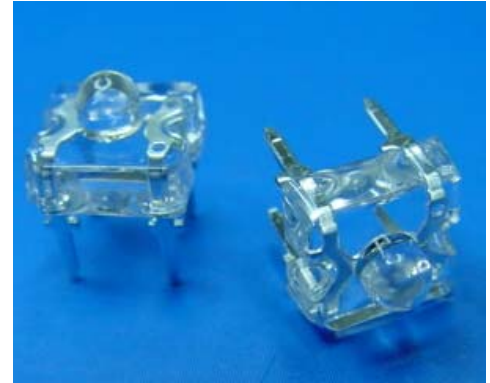

Descriptions

This revolutionary package design allows the light designer to reduce the number of LEDs required and provide a more uniform and unique illuminated appearance than with other LED solutions. This is possible through the efficient optical package design and high-current capabilities.

The low profile package can be easily coupled with reflectors or lenses to efficiently distribute light and provide the desired light appearance.

Applications

- . Automotive Exterior Lighting
- . Electronic Signs and Signals
- . Special Lighting application

Device Selection Guide

PART NO.	Chip		Lens Color
	Material	Emitted Color	
31-01USOC	AlGaInP	Super Sunset Orange	Water Clear

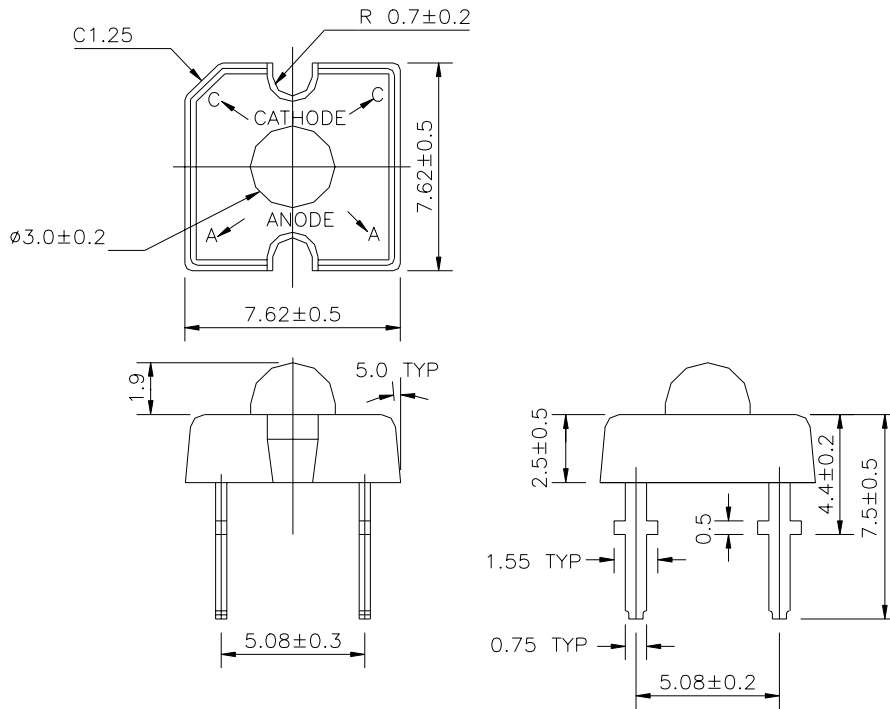
Package Dimensions

- Notes:**
1. All dimensions are in millimeters
 2. An epoxy meniscus may extend about 1.5mm(0.059") down the leads
 3. Tolerances unless dimensions ± 0.25 mm

Absolute Maximum Ratings ($T_a=25^\circ\text{C}$)

Parameter	Symbol	Rating	Units
Continuous Forward Current	I_F	70	mA
Peak Forward Current(Duty 1/10 @ 1KHZ)	I_{FP}	160	mA
Reverse Voltage	V_R	5	V
Operating Temperature	T_{opr}	-40 ~ +85	$^\circ\text{C}$
Storage Temperature	T_{stg}	-40 ~ +100	$^\circ\text{C}$
Soldering Temperature($T=5$ sec)	T_{sol}	260 ± 5	$^\circ\text{C}$
LED Junction Temperature	T_j	115	$^\circ\text{C}$
Power Dissipation	P_d	220	mW
Electrostatic Discharge	ESD	2000	V

Electro-Optical Characteristics (Ta=25°C)

Parameter	Symbol	Min.	Typ.	Max.	Condition	Unit
Total Flux	Φ_v	990	1440	----	I _F =70mA	mlm
Viewing Angle	$2\theta_{1/2}$	----	50	----	I _F =70mA	deg
Peak Wavelength	λ_p	----	621	----	I _F =20mA	nm
Dominant Wavelength	λ_d	----	615	----	I _F =20mA	nm
Spectrum Radiation Bandwidth	$\Delta\lambda$	----	18	----	I _F =20mA	nm
Forward Voltage	V _F	----	2.4	----	I _F =70mA	V
Reverse Current	I _R	----	----	10	V _R =5V	uA

Rank

31-01USOC

 (1) (2) (3)

(1) V _F (V)			(2) λ_d (nm)			(3) Φ_v (mlm)		
Bin	Min	Max	Bin	Min	Max	Bin	Min	Max
0	1.95	2.19	1	611	618	W	990	1760
1	2.07	2.31	2	614	622	X	1440	2750
2	2.19	2.43				Y	2250	4100
3	2.31	2.55						
4	2.43	2.67						
5	2.55	2.79						
6	2.67	2.91						
7	2.79	3.03						
8	2.91	3.15						

 *Measurement Uncertainty of Forward Voltage : $\pm 0.1V$

 *Measurement Uncertainty of Luminous Intensity: $\pm 15\%$

Typical Electro-Optical Characteristics Curves

Relative Intensity vs. Wavelength

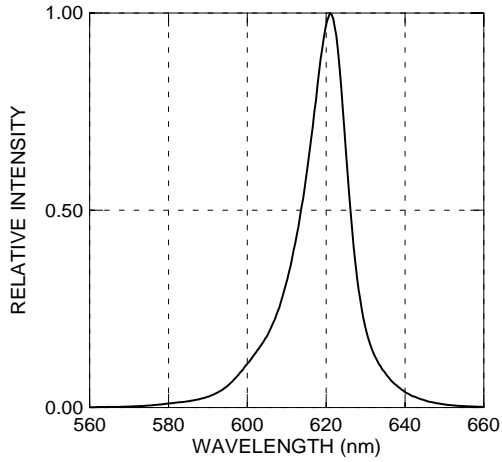

Forward Current vs. Forward Voltage

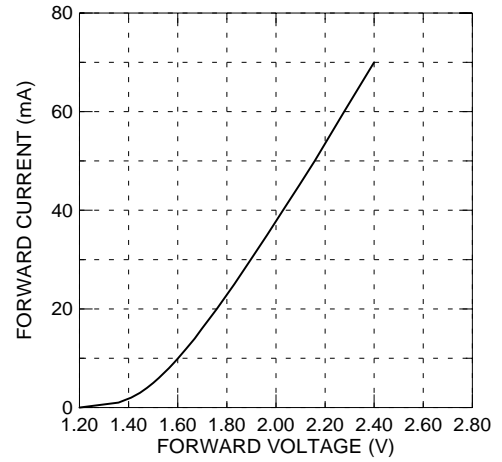

Relative Intensity vs. Forward Current

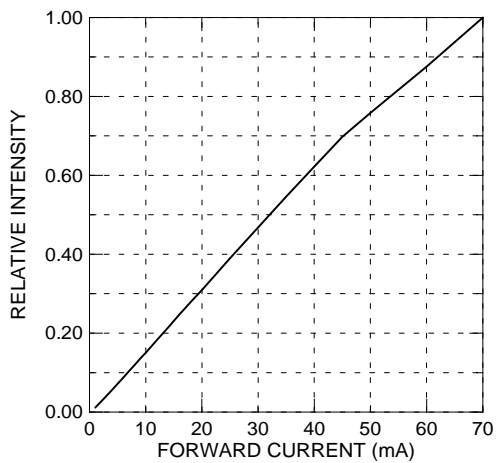

Forward Current vs. Ambient Temp.

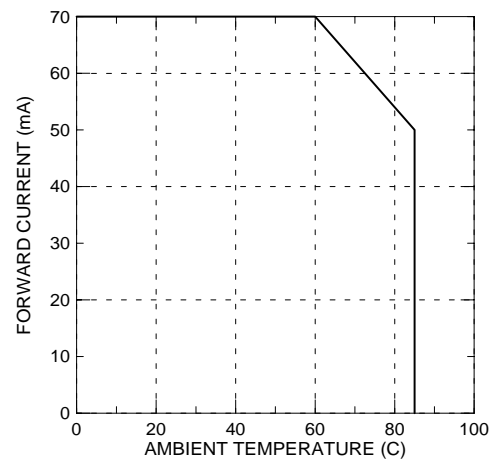

Relative Intensity vs. Angle Displacement

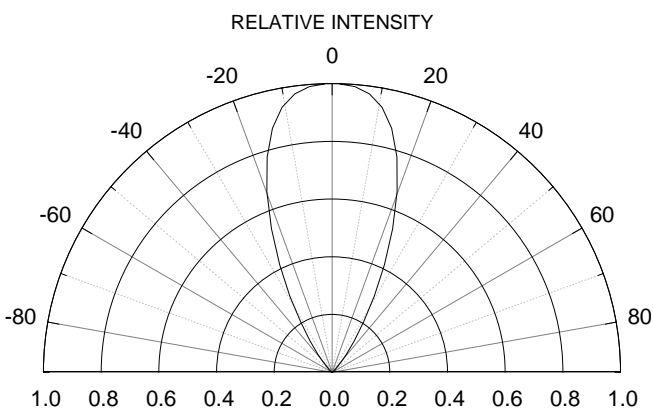

Relative Intensity vs. Off Axis Angle

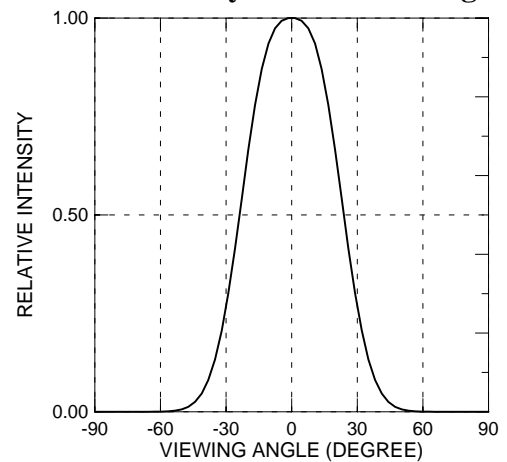

Label Form Specification

EVERLIGHT	
CPN:	
P/N:	
	
31-01USOC	
QTY :	CAT:
	HUE:
LOT NO :	REF:
	
MADE IN TAIWAN	

CPN: Customer's Production Number
P/N : Production Number
QTY: Packing Quantity
CAT: Ranks
HUE: Space
REF: Reference
LOT No: Lot Number
MADE IN TAIWAN: Production Place

Notes

1. Above specification may be changed without notice. EVERLIGHT will reserve authority on material change for above specification.
2. When using this product, please observe the absolute maximum ratings and the instructions for using outlined in these specification sheets. EVERLIGHT assumes no responsibility for any damage resulting from use of the product which does not comply with the absolute maximum ratings and the instructions included in these specification sheets.
3. These specification sheets include materials protected under copyright of EVERLIGHT corporation. Please don't reproduce or cause anyone to reproduce them without EVERLIGHT's consent.

EVERLIGHT ELECTRONICS CO., LTD. Office: No 25, Lane 76, Sec 3, Chung Yang Rd, Tucheng, Taipei 236, Taiwan, R.O.C	Tel: 886-2-2267-2000, 2267-9936 Fax: 886-2267-6244, 2267-6189, 2267-6306 http://www.everlight.com
---	--