

3185 THRU 3189

HALL-EFFECT LATCHES FOR HIGH-TEMPERATURE OPERATION

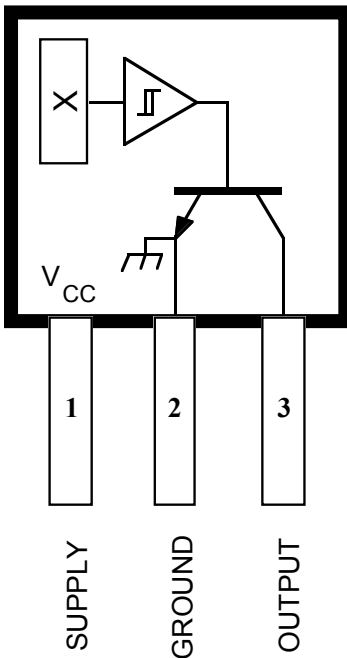

Dwg. PH-003A

Pinning is shown viewed from branded side.

ABSOLUTE MAXIMUM RATINGS at $T_A = +25^\circ\text{C}$

Supply Voltage, V_{CC}	30 V
Reverse Battery Voltage, V_{RCC}	-30 V
Magnetic Flux Density, B	Unlimited
Output OFF Voltage, V_{OUT}	30 V
Reverse Output Voltage, V_{OUT}	-0.5 V
Continuous Output Current, I_{OUT}	25 mA
Operating Temperature Range, T_A	
Suffix 'E-'	-40°C to +85°C
Suffix 'L-'	-40°C to +150°C
Storage Temperature Range,	
T_S	-65°C to +170°C

These Hall-effect latches are extremely temperature-stable and stress-resistant devices especially suited for operation over extended temperature ranges to +150°C. Superior high-temperature performance is made possible through a novel Schmitt trigger circuit that maintains operate and release point symmetry by compensating for temperature changes in the Hall element. Additionally, internal compensation provides magnetic switch points that become more sensitive with temperature, hence offsetting the usual degradation of the magnetic field with temperature. The symmetry capability makes these devices ideal for use in pulse-counting applications where duty cycle is an important parameter. The four basic devices (3185, 3187, 3188, and 3189) are identical except for magnetic switch points.

Each device includes on a single silicon chip a voltage regulator, quadratic Hall-voltage generator, temperature compensation circuit, signal amplifier, Schmitt trigger, and a buffered open-collector output to sink up to 25 mA. The on-board regulator permits operation with supply voltages of 3.8 to 24 volts.

The first character of the part number suffix determines the device operating temperature range. Suffix 'E-' is for -40°C to +85°C, and suffix 'L-' is for -40°C to +150°C. Three package styles provide a magnetically optimized package for most applications. Suffix '-LT' is a miniature SOT89/TO-243AA transistor package for surface-mount applications; suffix '-UA' is a three-lead ultra-mini-SIP.

FEATURES

- Symmetrical Switch Points
- Superior Temperature Stability
- Operation From Unregulated Supply
- Open-Collector 25 mA Output
- Reverse Battery Protection
- Activate With Small, Commercially Available Permanent Magnets
- Solid-State Reliability
- Small Size
- Resistant to Physical Stress

Always order by complete part number: the prefix 'A' + the basic four-digit part number + a suffix to indicate operating temperature range + a suffix to indicate package style, e.g., **A3185ELT**.

3185 THRU 3189 HALL-EFFECT LATCHES FOR HIGH-TEMPERATURE OPERATION

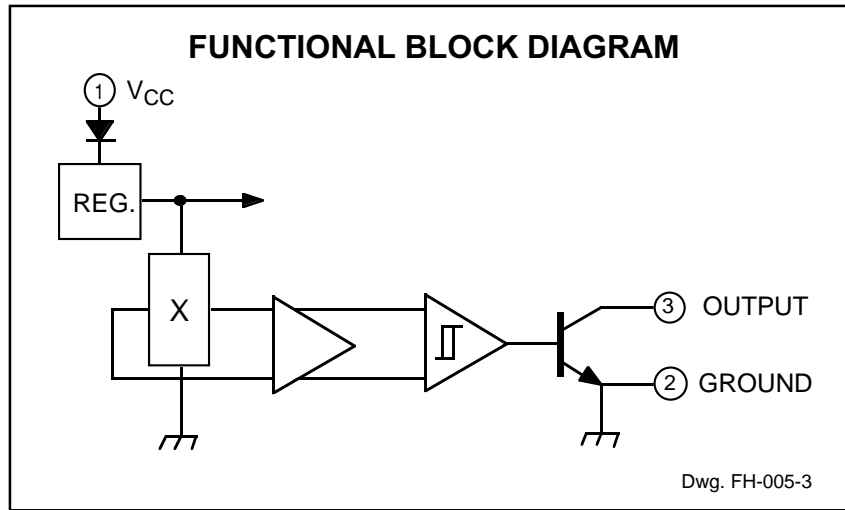

ELECTRICAL CHARACTERISTICS over operating temperature range, at $V_{CC} = 12\text{ V}$.

Characteristic	Symbol	Test Conditions	Limits			
			Min.	Typ.	Max.	Units
Supply Voltage	V_{CC}	Operating	3.8	—	24	V
Output Saturation Voltage	$V_{OUT(SAT)}$	$I_{OUT} = 20\text{ mA}$, $B > B_{OP}$	—	175	400	mV
Output Leakage Current	I_{OFF}	$V_{OUT} = 24\text{ V}$, $B < B_{RP}$	—	0.05	5.0	μA
Supply Current	I_{CC}	$B < B_{RP}$ (Output OFF)	—	4.75	8.0	mA
		$B > B_{OP}$ (Output ON)	—	5.7	—	mA
Output Rise Time	t_r	$R_L = 820\ \Omega$, $C_L = 20\text{ pF}$	—	100	—	ns
Output Fall Time	t_f	$R_L = 820\ \Omega$, $C_L = 20\text{ pF}$	—	100	—	ns

MAGNETIC CHARACTERISTICS in gauss over operating supply voltage range.

Characteristic	Part Numbers*							
	A3185		A3187		A3188		A3189	
	Min.	Max.	Min.	Max.	Min.	Max.	Min.	Max.
B_{OP} at $T_A = 25^\circ\text{C}$	170	270	50	150	100	180	50	230
over operating temp. range	140	300	50	175	80	200	50	250
B_{RP} at $T_A = 25^\circ\text{C}$	-270	-170	-150	-50	-180	-100	-230	-50
over operating temp. range	-300	-140	-175	-50	-200	-80	-250	-50
B_{hys} at $T_A = 25^\circ\text{C}$	340	540	100	300	200	360	100	460
over operating temp. range	280	600	100	350	160	400	100	500

NOTES: B_{OP} = operate point (output turns ON); B_{RP} = release point (output turns OFF); B_{hys} = hysteresis ($B_{OP} - B_{RP}$).

As used here, negative flux densities are defined as less than zero (algebraic convention).

*Complete part number includes a suffix to identify operating temperature range (E or L) and package type (LT or UA).



3185 THRU 3189 HALL-EFFECT LATCHES FOR HIGH-TEMPERATURE OPERATION

TYPICAL OPERATING CHARACTERISTICS

A3185* SWITCH POINTS

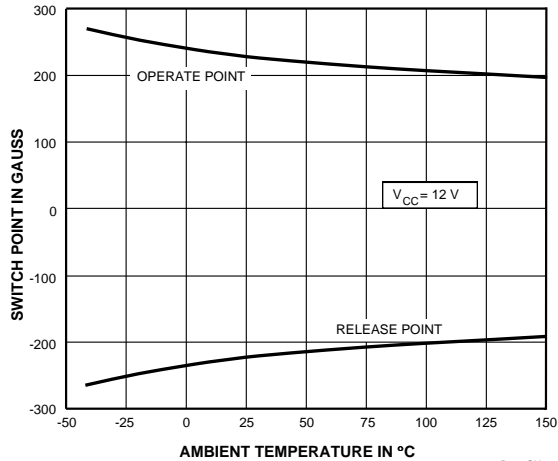

A3187* SWITCH POINTS

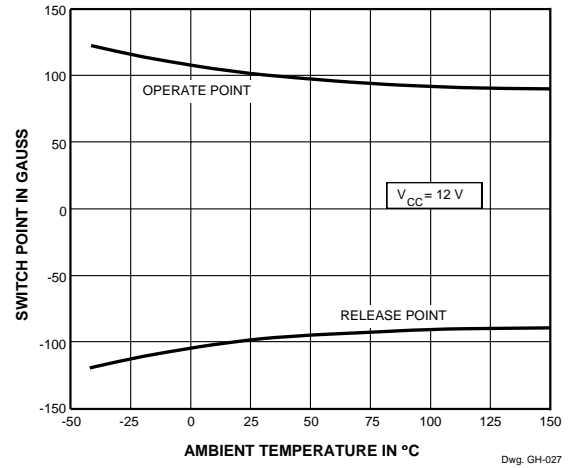

OUTPUT SATURATION VOLTAGE

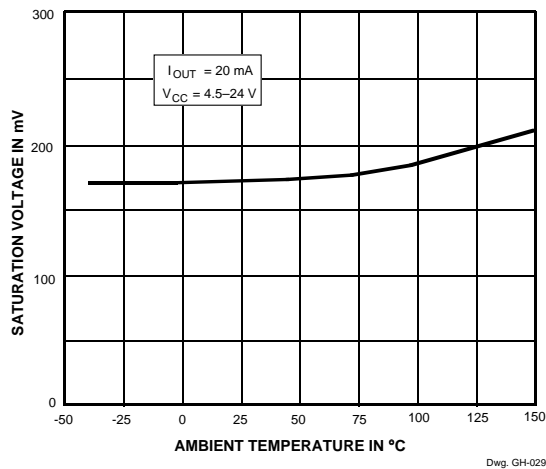

SUPPLY CURRENT

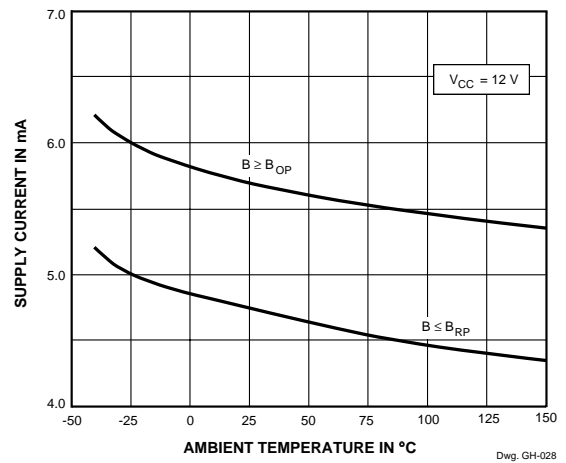

SUPPLY CURRENT

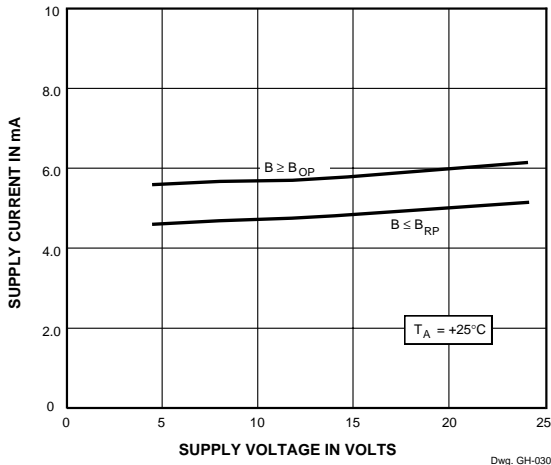

OPERATE POINT

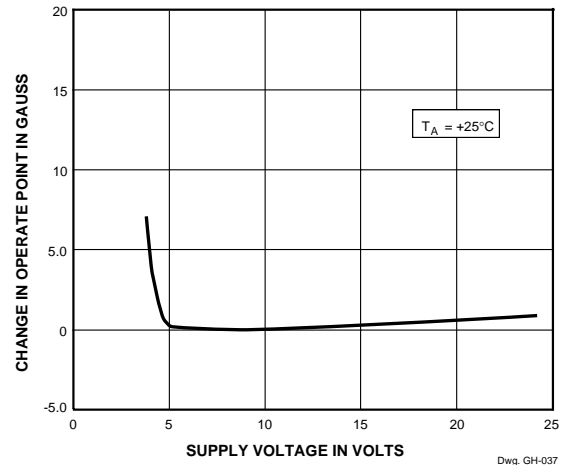

* Complete part number includes a suffix denoting operating temperature range (E or L) and package type (LT or UA).

3185 THRU 3189 HALL-EFFECT LATCHES FOR HIGH-TEMPERATURE OPERATION

ELEMENT LOCATIONS

(± 0.005 " [0.13 mm] die placement)

Package Designators "LT"

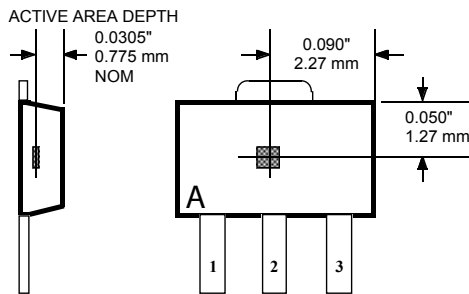

Dwg. MH-008-4C

Package Designators "UA"

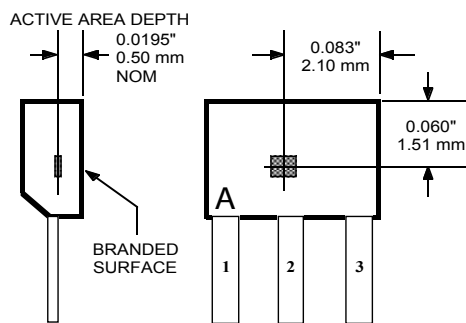

Dwg. MH-011-4C

Although element location is accurate to three sigma for a particular design, product improvements may result in small changes to element location.

OPERATION

In operation, the output transistor is OFF until the strength of the magnetic field perpendicular to the surface of the chip exceeds the threshold or operate point (B_{OP}). When the field strength exceeds B_{OP} , the output transistor switches ON and is capable of sinking 25 mA of current.

The output transistor switches OFF when magnetic field reversal results in a magnetic flux density below the OFF threshold (B_{RP}). This is illustrated in the transfer characteristics graph (A3187* shown).

Note that the device latches; that is, a south pole of sufficient strength will turn the device ON. Removal of the south pole will leave the device ON. The presence of a north pole of sufficient strength is required to turn the device OFF. Powering up in the absence of a magnetic field (less than B_{OP} and higher than B_{RP}) will allow an indeterminate output state. The correct state is warranted after the first excursion beyond B_{OP} or B_{RP} .

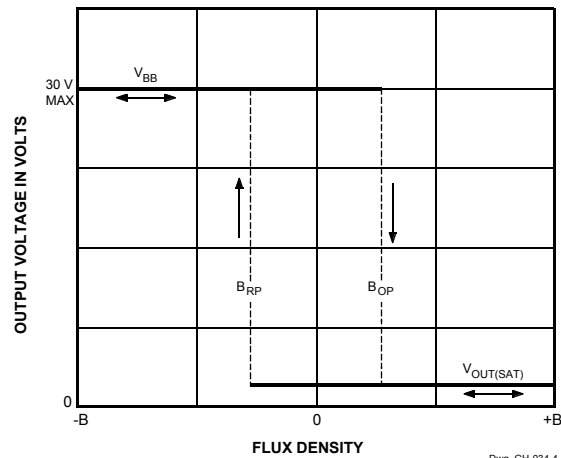

The simplest form of magnet that will operate these devices is a ring magnet, as shown below. Other methods of operation are possible.

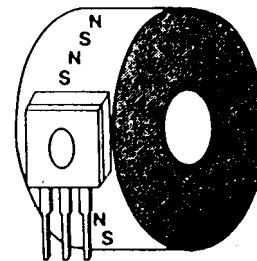

Dwg. A-11,899

APPLICATIONS INFORMATION

Extensive applications information on magnets and Hall-effect devices is also available in the *Allegro Integrated and Discrete Semiconductors Data Book* or *Application Note 27701*.

3185 THRU 3189 HALL-EFFECT LATCHES FOR HIGH-TEMPERATURE OPERATION

PACKAGE DESIGNATOR 'LT' (SOT89/TO-243AA)

Dimensions in Inches (for reference only)

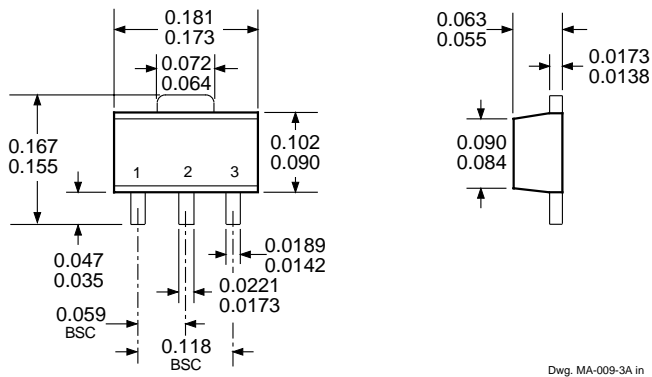

Dimensions in Millimeters (controlling dimensions)

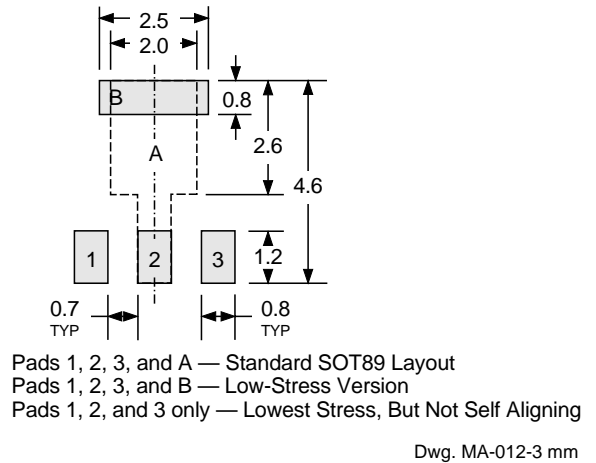
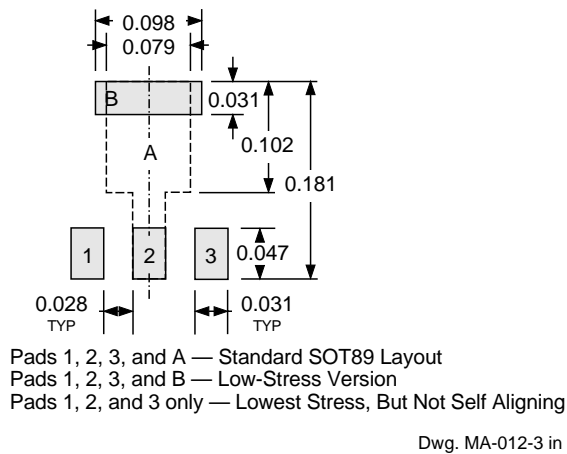
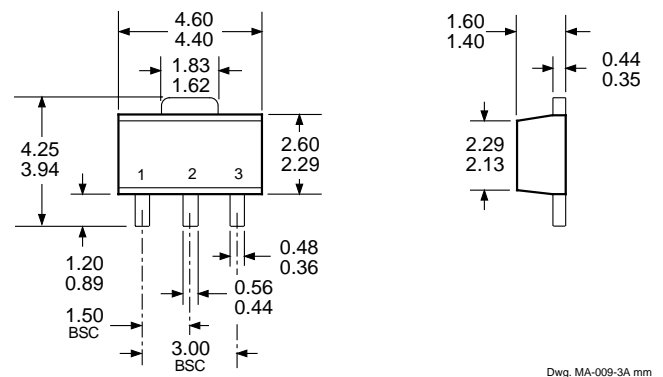

- NOTES: 1. Exact body and lead configuration at vendor's option within limits shown.
2. Supplied in bulk pack (500 pieces per bag) or add "TR" to part number for tape and reel.
3. Only low-temperature ($\leq 240^{\circ}\text{C}$) reflow-soldering techniques are recommended for SOT89 devices.

3185 THRU 3189 HALL-EFFECT LATCHES FOR HIGH-TEMPERATURE OPERATION

PACKAGE DESIGNATOR 'UA'

Dimensions in Inches
(controlling dimensions)

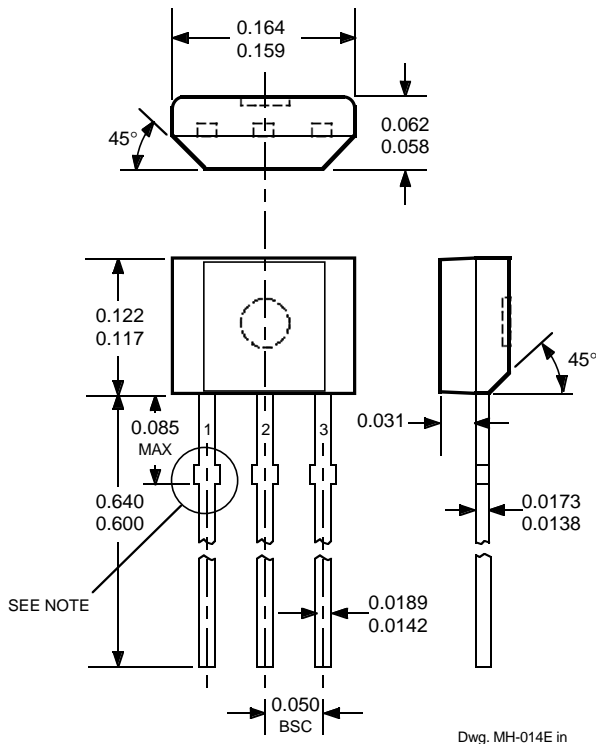

Dimensions in Millimeters
(for reference only)

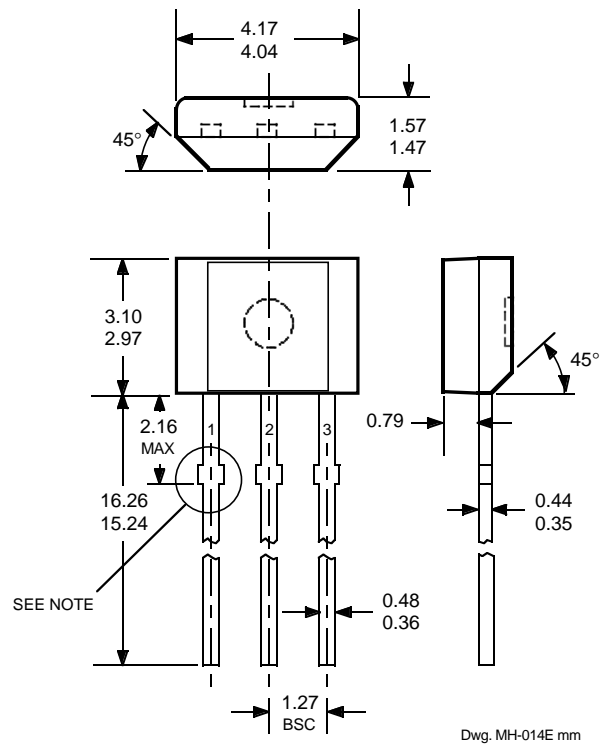

- NOTES: 1. Tolerances on package height and width represent allowable mold offsets. Dimensions given are measured at the widest point (parting line).
2. Exact body and lead configuration at vendor's option within limits shown.
3. Height does not include mold gate flash.
4. Recommended minimum PWB hole diameter to clear transition area is 0.035" (0.89 mm).
5. Where no tolerance is specified, dimension is nominal.
6. Supplied in bulk pack (500 pieces per bag).

Radial Lead Form (order A318xxUA-LC)

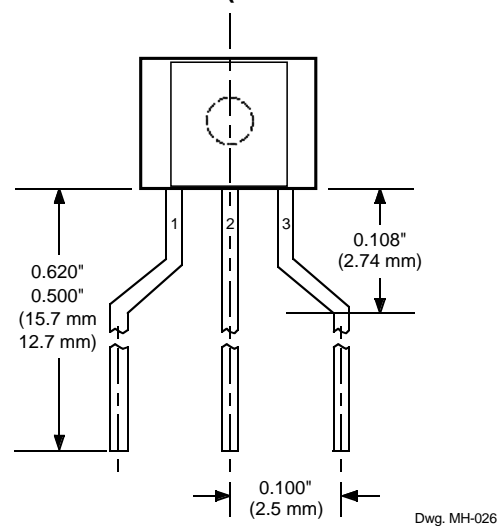

NOTE: Lead-form dimensions are the nominals produced on the forming equipment. No dimensional tolerance is implied or guaranteed for bulk packaging (500 pieces per bag).

3185 THRU 3189
HALL-EFFECT LATCHES
FOR HIGH-TEMPERATURE
OPERATION

The products described herein are manufactured under one or more of the following U.S. patents: 5,045,920; 5,264,783; 5,442,283; 5,389,889; 5,581,179; 5,517,112; 5,619,137; 5,621,319; 5,650,719; 5,686,894; 5,694,038; 5,729,130; 5,917,320; and other patents pending.

Allegro MicroSystems, Inc. reserves the right to make, from time to time, such departures from the detail specifications as may be required to permit improvements in the performance, reliability, or manufacturability of its products. Before placing an order, the user is cautioned to verify that the information being relied upon is current.

Allegro products are not authorized for use as critical components in life-support appliances, devices, or systems without express written approval.

The information included herein is believed to be accurate and reliable. However, Allegro MicroSystems, Inc. assumes no responsibility for its use; nor for any infringements of patents or other rights of third parties that may result from its use.