

3260

2-WIRE, CHOPPER-STABILIZED, PRECISION HALL-EFFECT BIPOLAR SWITCH

Suffix Code 'LH' Pinning (SOT23W)

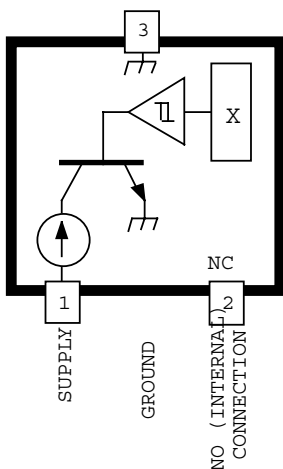

Dwg. PH-003-5

Pinning is shown viewed from branded side.

ABSOLUTE MAXIMUM RATINGS at $T_A=+25^\circ\text{C}$

Supply Voltage, V_{CC}	27 V
Reverse Battery Voltage, V_{RCC}	-16 V
Magnetic Flux Density, B	Unlimited
Package Power Dissipation, P_D . See Graph	
Junction Temperature, T_J	+165°C
Operating Temperature Range, T_A	
Suffix 'E-'	-40°C to +85°C
Suffix 'L-'	-40°C to +150°C
Storage Temperature Range,	
T_S	-65°C to +170°C

The A3260-- Hall-effect bipolar switch is an extremely temperature-stable and stress-resistant sensor IC especially suited for operation over extended temperature ranges to +150°C. Superior high-temperature performance is made possible through dynamic offset cancellation, which reduces the residual offset voltage normally caused by device overmolding, temperature dependencies, and thermal stress.

The device includes on a single silicon chip a voltage regulator, Hall-voltage generator, small-signal amplifier, chopper stabilization, Schmitt trigger, and a constant-current open-collector output. A south pole of sufficient strength will turn the output OFF. An on-board regulator permits operation with supply voltages of 3.5 to 24 volts. Noise radiation is limited by control of the output current slew rate.

The first character of the part number suffix determines the device operating temperature range; suffix 'E-' is -40°C to +85°C and 'L-' is -40°C to +150°C. Two package styles provide a magnetically optimized package for most applications. Suffix '-LH' is a miniature SOT23W low-profile surface-mount package, while suffix '-UA' is a three-lead ultra-mini-SIP for through-hole mounting.

FEATURES

- Internal Current Regulator for 2-Wire Operation
- Output Slew Rate Controlled
- Resistant to Physical Stress
- Superior Temperature Stability
- Operation From Unregulated Supply
- Reverse Battery Protection
- Solid-State Reliability
- Small Size

3260 2-WIRE, CHOPPER-STABILIZED, PRECISION HALL-EFFECT BIPOLAR SWITCH

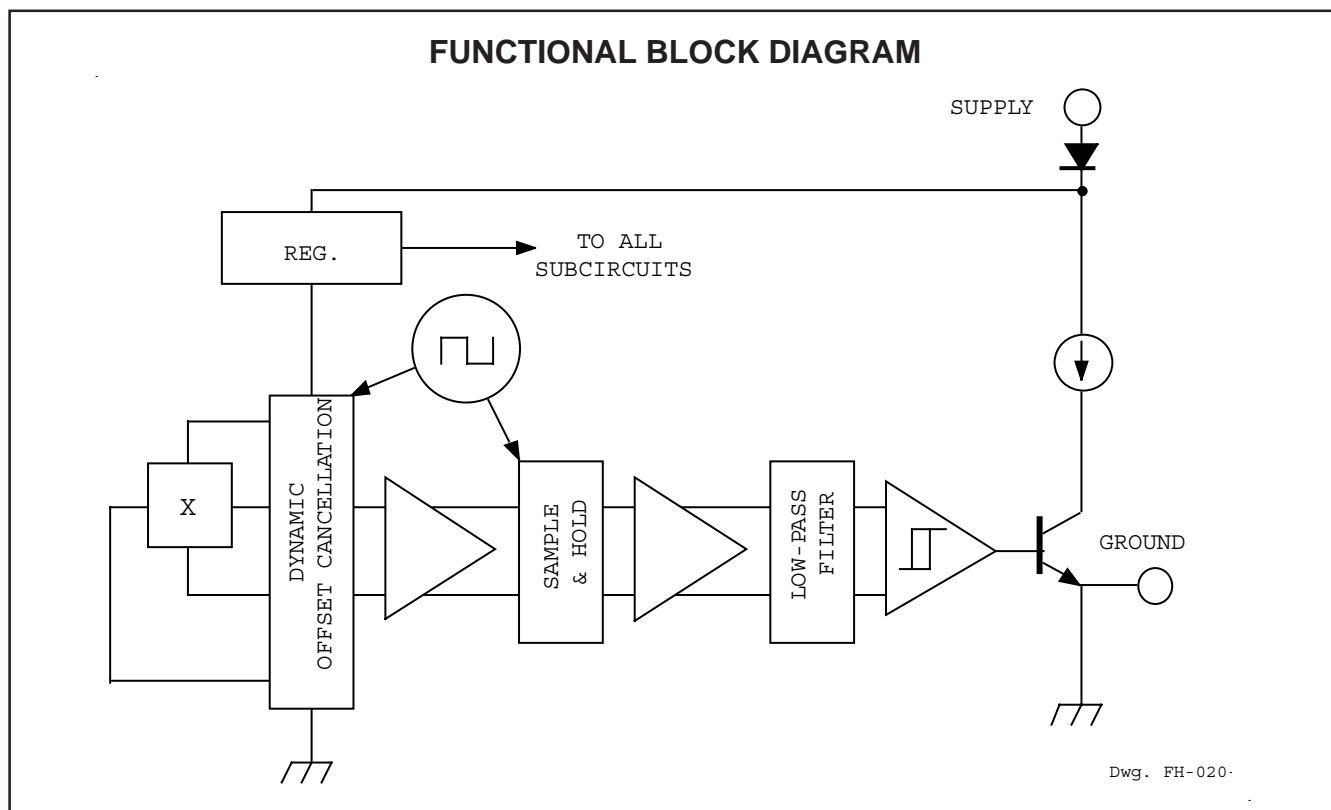

Selection Guide

Part Number ¹	Pb-Free	Packing ²	Mounting	Ambient, T _A (°C)
A3260ELHLT	–	7-in. reel, 3000 pieces/reel	3-pin SOT23W surface mount	–40 to 85
A3260EUA	–	Bulk, 500 pieces/bag	3-pin SIP through hole	–40 to 85

¹Certain variants cited in this footnote are in production but have been determined to be LAST TIME BUY. This classification indicates that the product is obsolete and notice has been given. Sale of this device is currently restricted to existing customer applications. The variants should not be purchased for new design applications because of obsolescence in the near future. Samples are no longer available. Status date change October 31, 2006. Deadline for receipt of LAST TIME BUY orders is April 27, 2007. These variants include: A3260ELHLT and A3260EUA. Variants A3260LLHLT and A3260LUA are discontinued.

²Contact Allegro for additional packing options.

3260
2-WIRE, CHOPPER-STABILIZED,
PRECISION HALL-EFFECT
BIPOLAR SWITCH

ELECTRICAL CHARACTERISTICS over operating supply voltage and temperature ranges.

Characteristic	Symbol	Test Conditions	Limits			Units
			Min.	Typ.	Max.	
Supply Voltage	V_{CC}	Operating	3.5	12	24	V
Output Current	$I_{GND(L)}$	$B > B_{OP}$	-4.0	-6.5	-8.0	mA
	$I_{GND(H)}$	$B < B_{RP}$	-11	-14.5	-18	mA
Chopping Frequency	f_C		–	340	–	kHz
Output Slew Rate	di/dt	$C_L = 20$ pF	0.5	—	2.0	mA/ μ s
Output Settling Time	t_{sd}	$C_L = 20$ pF	—	—	20	μ s
Reverse Battery Current	I_{CC}	$V_{RCC} = -16$ V	–	–	-15	mA

NOTES: 1. B_{OP} = operate point (output turns OFF); B_{RP} = release point (output turns ON).
2. Typical Data is at $T_A = +25^\circ\text{C}$ and $V_{CC} = 12$ V and is for design information only.

MAGNETIC CHARACTERISTICS over operating supply voltage and temperature ranges.

Characteristic	Symbol	Test Conditions	Limits			Units
			Min.	Typ.	Max.	
Operate Point	B_{OP}		–	10	40	G
Release Point	B_{RP}		-40	-10	–	G
Hysteresis	B_{hys}	$B_{OP} - B_{RP}$	2.0	20	–	G

NOTES: 1. Typical Data is at $T_A = +25^\circ\text{C}$ and $V_{CC} = 12$ V and is for design information only.
2. 1 gauss (G) is exactly equal to 0.1 millitesla (mT).

3260 2-WIRE, CHOPPER-STABILIZED, PRECISION HALL-EFFECT BIPOLAR SWITCH

ELEMENT LOCATIONS

Package Designator "LH"

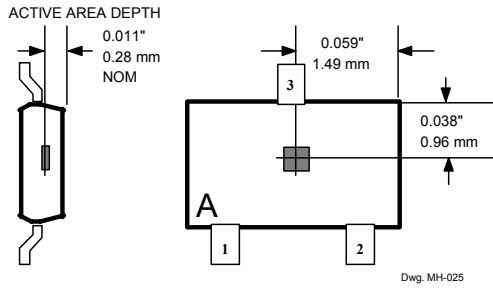

Package Designators "UA"

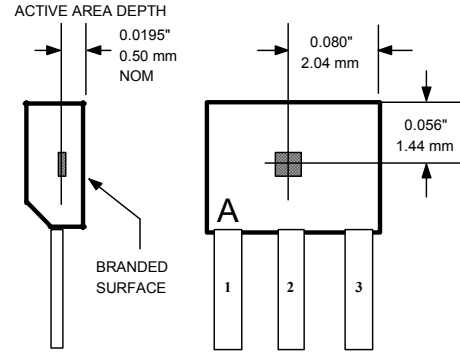

Although element location is accurate to three sigma for a particular design, product improvements may result in small changes to element location.

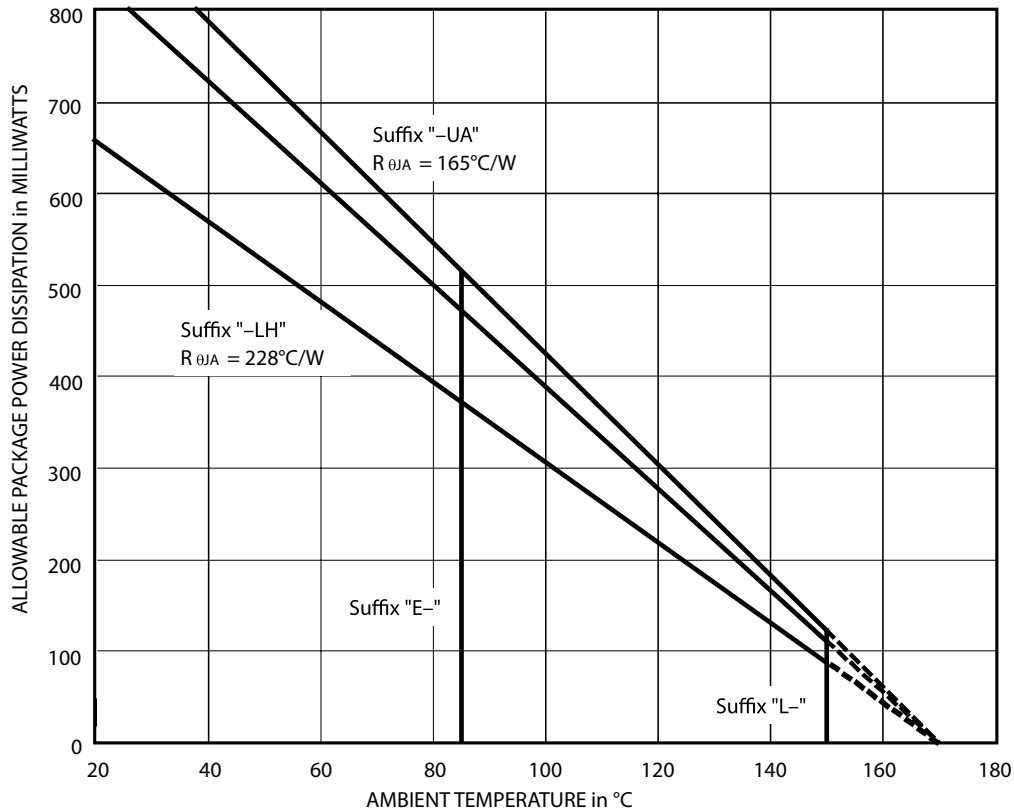

3260 2-WIRE, CHOPPER-STABILIZED, PRECISION HALL-EFFECT BIPOLAR SWITCH

FUNCTIONAL DESCRIPTION

Chopper-Stabilized Technique. These devices use a proprietary dynamic offset cancellation technique, with an internal high-frequency clock to reduce the residual offset voltage of the Hall element that is normally caused by device overmolding, temperature dependencies, and thermal stress. This technique produces devices that have an extremely stable quiescent Hall output voltage, are immune to thermal stress, and have precise recoverability after temperature cycling. This technique will also slightly degrade the device output repeatability.

The Hall element can be considered as a resistor array similar to a Wheatstone bridge. A large portion of the offset is a result of the mismatching of these resistors. The chopper-stabilizing technique cancels the mismatching of the resistors by changing the direction of the current flowing through the Hall plate and Hall voltage measurement taps, while maintaining the Hall-voltage signal that is induced by the external magnetic flux. The signal is, then, captured by a sample-and-hold circuit.

Operation. The output of these devices turns ON when a magnetic field (north pole) perpendicular to the Hall element exceeds the release point threshold (B_{RP}). After turn-ON, the output will source current equal to the device operating current plus a current source ($I_{GND(H)}$). When the magnetic field is increased (south pole) above the operate point (B_{OP}), the output will source current equal to the device operating current with the current source turned OFF ($I_{GND(L)}$). Note especially that release can occur when the magnetic field is removed but to ensure release, a field reversal is required. The difference in the magnetic operate and release points is the hysteresis (B_{HYS}) of the device. The hysteresis allows clean switching of the output even in the presence of external mechanical vibration or electrical noise.

Powering up in the absence of a magnetic field (less than B_{OP} and higher than B_{RP}) will allow an indeterminate output state. The correct state is warranted after the first excursion beyond B_{OP} or B_{RP} .

Bipolar switches may switch on removal of field but require field reversal for reliable operation over temperature range; latches will not switch on removal of magnetic field.

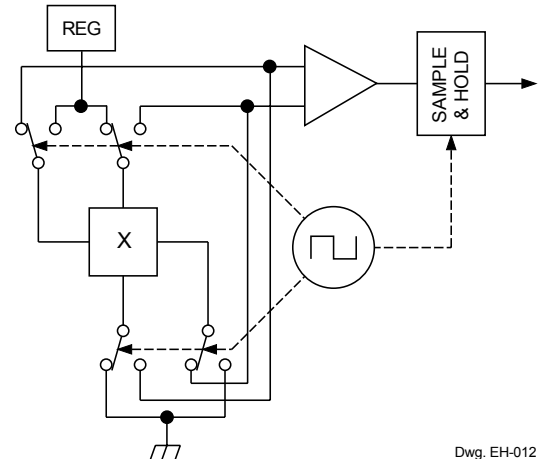

Dwg. EH-012

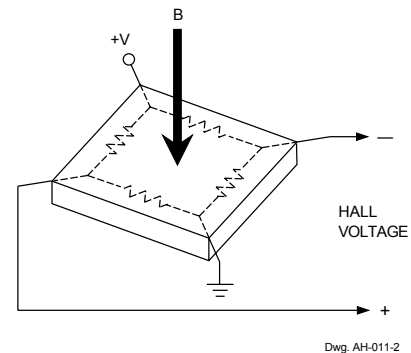

Dwg. AH-011-2

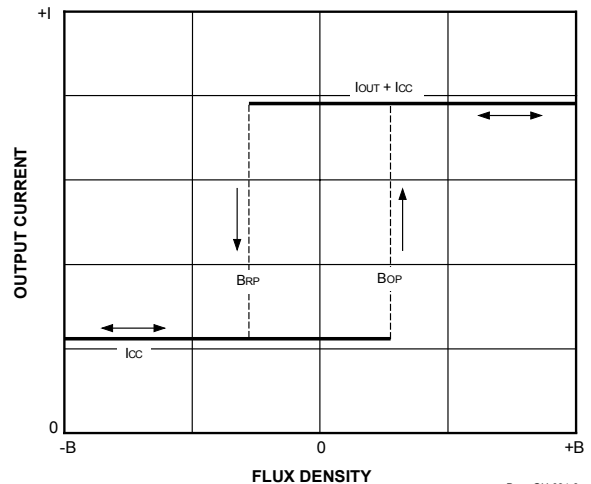

Dwg. GH-034-6

3260 2-WIRE, CHOPPER-STABILIZED, PRECISION HALL-EFFECT BIPOLAR SWITCH

APPLICATIONS INFORMATION

It is strongly recommended that an external bypass capacitor be connected (in close proximity to the Hall element) between the supply and ground of the device to reduce both external noise and noise generated by the chopper-stabilization technique.

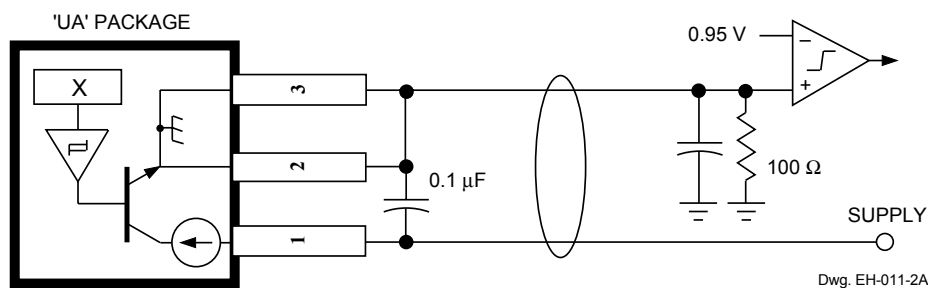

Extensive applications information for Hall-effect device is available in:

- *Hall-Effect IC Applications Guide*, Application Note 27701;
- *Hall-Effect Devices: Soldering, Gluing, Potting, Encapsulating, and Lead Forming*, Application Note 27703.1;
- *Soldering of Through-Hole Hall-Sensor Devices*, Application Note 27703; and
- *Soldering of Surface-Mount Hall-Sensor Devices*, Application Note 27703.2.

More detailed descriptions of the chopper-stabilized circuit operation can be found in:

- *Monolithic Magnetic Hall Sensor Using Dynamic Quadrature Offset Cancellation*, Technical Paper STP 97-10; and
- *Chopper-Stabilized Amplifiers With A Track-and-Hold Signal Demodulator*, Technical Paper STP 99-1.

All are provided at

www.allegromicro.com

3260

2-WIRE, CHOPPER-STABILIZED, PRECISION HALL-EFFECT BIPOLAR SWITCH

PACKAGE DESIGNATOR 'LH'

(fits SC-59A solder-pad layout)

Dimensions in Inches
(for reference only)

Dimensions in Millimeters
(controlling dimensions)

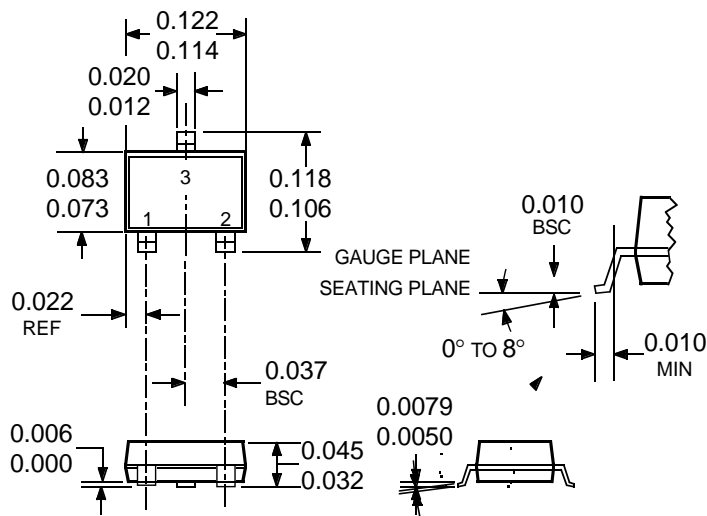

Dwg. MA-010-3D in

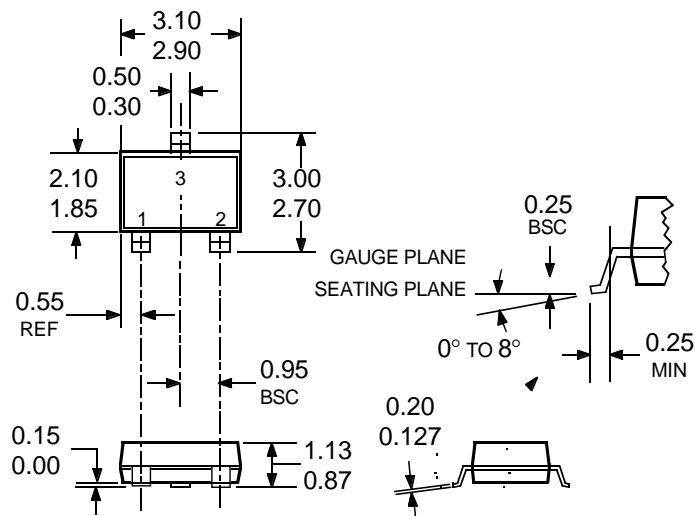

Dwg. MA-010-3D mm

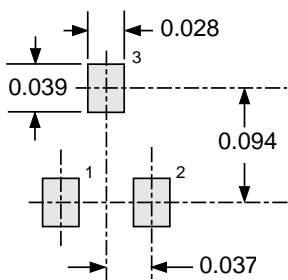

Dwg. MA-011-3 in

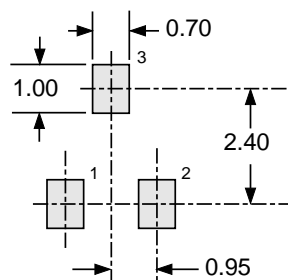

Dwg. MA-011-3 mm

- NOTES:
1. Tolerances on package height and width represent allowable mold offsets. Dimensions given are measured at the widest point (parting line).
 2. Exact body and lead configuration at vendor's option within limits shown.
 3. Height does not include mold gate flash.
 4. Where no tolerance is specified, dimension is nominal.
 5. Add "LT" to part number for tape and reel.

3260
2-WIRE, CHOPPER-STABILIZED,
PRECISION HALL-EFFECT
BIPOLAR SWITCH

PACKAGE DESIGNATOR 'UA'

Dimensions in Inches
 (controlling dimensions)

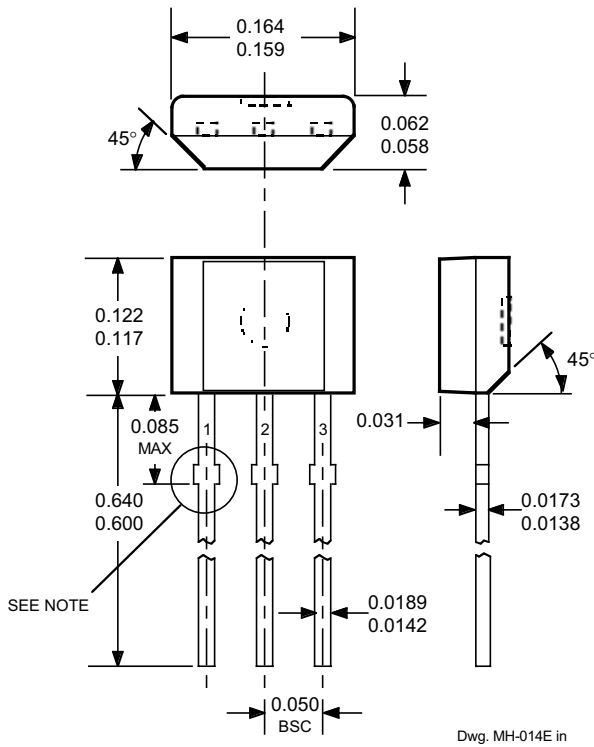

Dimensions in Millimeters
 (for reference only)

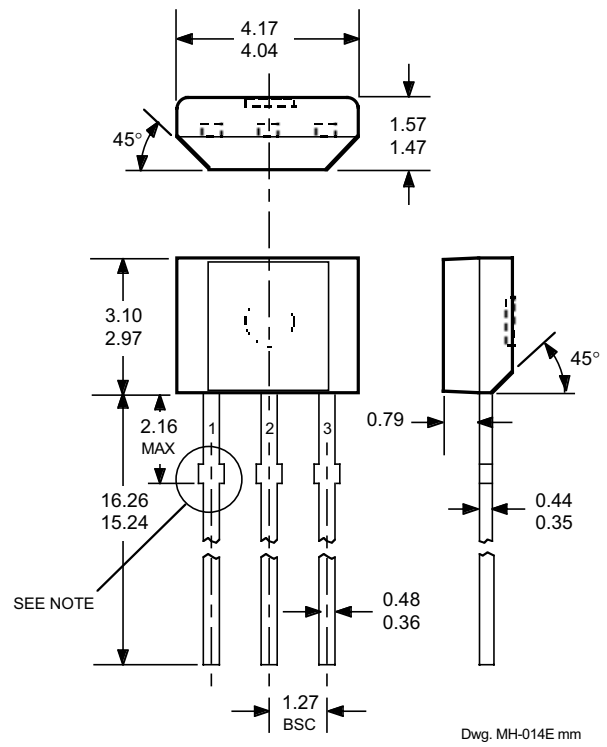

- NOTES: 1. Tolerances on package height and width represent allowable mold offsets. Dimensions given are measured at the widest point (parting line).
2. Exact body and lead configuration at vendor's option within limits shown.
3. Height does not include mold gate flash.
4. Recommended minimum PWB hole diameter to clear transition area is 0.035" (0.89 mm).
5. Where no tolerance is specified, dimension is nominal.
6. Supplied in bulk pack (500 pieces per bag).

3260
2-WIRE, CHOPPER-STABILIZED,
PRECISION HALL-EFFECT
BIPOLAR SWITCH

Suffix Code 'UA' Pinning
(ultra-mini SIP)

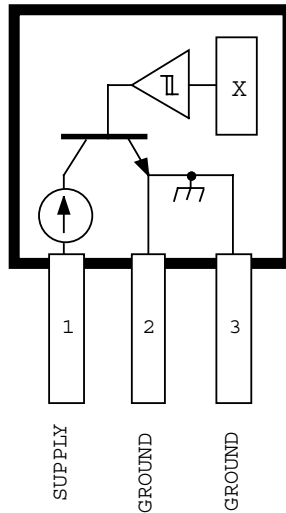

Dwg. PH-003-7A

Pinning is shown viewed from branded side.

The products described herein are manufactured under one or more of the following U.S. patents: 5,045,920; 5,264,783; 5,442,283; 5,389,889; 5,581,179; 5,517,112; 5,619,137; 5,621,319; 5,650,719; 5,686,894; 5,694,038; 5,729,130; 5,917,320; and other patents pending.

Allegro MicroSystems, Inc. reserves the right to make, from time to time, such departures from the detail specifications as may be required to permit improvements in the performance, reliability, or manufacturability of its products. Before placing an order, the user is cautioned to verify that the information being relied upon is current.

Allegro products are not authorized for use as critical components in life-support appliances, devices, or systems without express written approval.

The information included herein is believed to be accurate and reliable. However, Allegro MicroSystems, Inc. assumes no responsibility for its use; nor for any infringements of patents or other rights of third parties that may result from its use.