

TOSHIBA
Leading Innovation >>>

OWNER'S MANUAL

LCD Colour TV

HDMI[®]
HIGH-DEFINITION MULTIMEDIA INTERFACE

32AV700E
32AV700T
32AV700V
40AV700E
40AV700T
40AV700V

Owner's Record

You will find the model number and serial number on the back of the TV. Record these numbers in the spaces provided below. Refer to them whenever you call upon your TOSHIBA dealer regarding this product.

Model number:

Serial number:

Contents

Introduction / Getting started

Connecting an aerial	7
Exploring your new TV	7
TV front and side panel controls	7
TV back panel connections	8
Learning about the remote control	9
Turning the TV on	10
Tuning the TV for the first time	10
Using the Quick Menu	11
Learning about the menu system	11
Watching TV programmes	12
Programming channels into the TV's channel memory	12

Using the TV's features

Picture adjustment	15
Sound adjustment	18
Other features settings	19
Selecting the video input source to view	20
Channel List	21
Teletext	21

Connecting your TV

Back connections	24
Connecting HDMI or DVI devices	24
Selecting the PC/HDMI 1 Audio mode	25
Setting the HDMI 1 Audio mode	25
Connecting a computer	26
Using the PC Settings	27
Using the Media Player	27

Reference section

Troubleshooting	30
Broadcast system	30
Specifications	31

Welcome to Toshiba

- Thank you for purchasing this Toshiba LCD Colour TV. This manual will help you use the exciting features of your new TV.
- Instructions in this manual are based on using the remote control.

- You also can use the controls on the TV if they have the same name as those referred to on the remote control.
- Please read all safety and operating instructions in this manual carefully, and keep this manual for future reference.

Important Safety Instructions

Be sure to observe the following instructions and precautions to ensure safe use of this TV.

Installation

- 1) **Always connect the power plug to an appropriate electrical outlet equipped with 110-240V, AC 50/60Hz.**

Never use the TV outside the specified voltage range. It may cause a fire or an electric shock.



WARNING ABOUT THREE-WIRE GROUNDING-TYPE PLUG:

- This product shall be connected to a main socket outlet with a protective earthing connection.
- Never remove the earthing pin on the power plug. This system is equipped with a three pin earthing-type power plug. This plug will only fit an earthing-type power outlet. This is a safety feature. If you are unable to insert the plug into the outlet, contact an electrician to replace the wall outlet.
- Never defeat the purpose of the earthing plug.

About the fuse (Only for E models)

In a three pin earthing-type, the fuse fitted in this plug is approved by ASTA or BSI to BS1362. It should only be replaced by a correctly rated and approved type and the fuse cover must be refitted.

About the earth

An appliance with protective earth terminal should be connected to a mains outlet with a protective earth connection.

About the use

- Make sure to insert the plugs firmly, when plugging the AC power cord into the TV set end and wall outlet end.
- Make sure to hold the plug, when unplugging the AC power cord.

- Never use other cord except for supplied AC power cord, and never use the supplied power cord for any other purpose.

2) Never insert or remove the power plug with wet hands.

This may cause an electric shock.

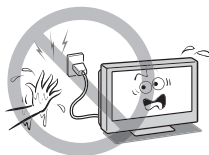

3) Never place the TV in an unstabilized location such as on a shaky table, incline or location subject to vibration.

- Only use cabinets or stands recommended by the TV manufacturer.
- Only use furniture that can safely support the TV.
- Ensure that the TV is not hanging over the edge of the supporting furniture.
- Never place the TV on tall furniture (for example, cupboards or bookcases) without anchoring both the furniture and the TV to a suitable support.

The TV may drop or fall off, which may cause an injury or damage.



4) Never block or cover the slots and openings in the cabinet.

- Never place the TV so that it is facing upward or on its side.
- Never place the TV in a closet, bookcase or other similar area where the ventilation is poor.
- Never drape a newspaper, tablecloth or curtain on the TV.
- Never stand the TV on cloth or other material placed between the TV and supporting furniture.
- When installing the TV against a wall, always keep the TV at least 10 cm away from the wall.
- Never place the TV on a soft unstable surface, such as a carpet, or a cushion.

The inside of this TV will overheat if the ventilation holes are covered, blocked or sealed, which may result in a fire.



5) Never place the TV near a heater or in direct sunlight.

The surface of the cabinet or power cord may melt and result in a fire or an electric shock.



6) Never place the TV in an area exposed to high humidity levels, such as in a bathroom or close to a humidifier.

This may cause a fire or an electric shock.



7) Never place the TV next to a stove where it will be exposed to oil, smoke, or steam, or in a location where there is a large quantity of dust.

This may cause a fire or an electric shock.



8) Install the TV in a horizontal, stable location. Attach the TV to the stand with the mounting screw (not supplied).

- If the TV is not installed securely, it may lean or fall over and cause an injury.

- To prevent injury, use the exclusive optional stand or wall-hanging bracket to install this TV on the floor or wall securely in accordance with a qualified technician.

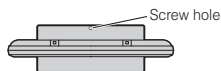

Top view

9) Precautions for moving the TV

- When moving the TV, be sure to remove the plug from the wall outlet and disconnect the aerial cable and audio/video cables, any steady ties and mounting screw. A fire or an electric shock may result if the power cord is damaged.
- When carrying the TV, at least two people are needed. Be sure to carry it upright.
- Never carry the TV with the screen facing up or down.



10) Precautions for installing on outdoor aerial

An outside aerial system should not be located in the vicinity of overhead power lines, or other electric light or power circuits.

If the aerial falls down or drops, it may cause an injury or an electric shock.



Use

1) Never place hot objects or open flame sources, such as lighted candles or nightlights, on or close to the TV.

High temperatures can melt plastic and lead to fires.



2) The apparatus shall not be exposed to dripping or splashing and that no objects filled with liquids, such as vases, shall be placed on the apparatus.

When liquids are spilled or small items are dropped inside the TV, this may cause a fire or an electric shock.

If small objects drop inside the TV, turn off the TV and remove the power plug from the outlet immediately and contact a service technician.



3) Never insert objects (metal or paper) or pour water inside the TV through ventilation holes and other openings.

These items may cause a fire or an electric shock. If these objects are inserted inside the TV, turn off the TV and remove the power plug from the outlet immediately and contact a service technician. Be especially careful that children do not insert objects in the TV.



4) Never stand or climb on the TV.

- Educate children about the dangers of climbing on furniture to reach the TV or its controls.

Be especially careful in households with children to prevent them through climbing on top of the TV. It may move, fall over, break, become damaged or cause an injury.



- 5) **When the TV will not be used for a long period of time, such as during vacation or travel, remove the power plug from the wall outlet for safety.**

- The TV is not completely disconnected from the power supply line, as minute current is consumed even when the O/I Power switch is turned off.
- The Mains plug or an appliance coupler is used as the disconnect device, therefore the disconnect device shall remain readily operable.



- 6) **Never pull on the power cord when removing the plug from the wall outlet.**

Always hold the plug firmly when removing it. If the power cord is yanked, the cord may become damaged and a fire or an electric shock may occur.



- 7) **Never cut, break, modify, twist, bunch up or bent the cord or apply excessive force or tension to it.**

Never place heavy objects on the cord or allow it to overheat as this may cause damage, a fire or an electric shock. Contact a service technician if the power cord is damaged.

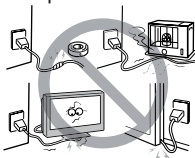

- 8) **If there is thunder or lightning, never touch the aerial cable or other connected cables.**

You may suffer an electric shock.



Service

- 1) **Never repair, modify or disassemble the TV by yourself.**

It may cause a fire or an electric shock.

Consult a service technician for inspection and repairs.



- 2) **When a malfunction occurs, or if smoke or an unusual odor comes from the TV, turn off the TV and remove the power plug from the outlet immediately.**

Make sure that the smoke or smell has stopped, then contact a service technician.

If the TV is still used in this condition, it may cause a fire or an electric shock.



- 3) **If the TV is dropped or the cabinet is broken, turn off the TV and remove the power plug from the outlet immediately.**

If the TV has power in this condition, it may cause a fire or an electric shock. If the cabinet is broken, be careful when handling the TV to prevent an injury.

Contact a service technician for inspection and repair.

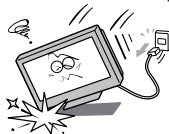

- 4) **When the TV reaches the end of its useful life, ask a qualified service technician to properly dispose of the TV.**

Note:

The lamp unit contains a small amount of mercury. Disposal of mercury may be regulated due to environmental considerations.

Dispose of the used lamp unit by the approved method for your area. For disposal or recycling information, please contact your local authorities.



Cleaning

1) Remove the power plug before cleaning.

Never use solvents such as benzene or thinner to clean the TV.

- These solvents may distort the cabinet or damage its finish.
- If rubber or vinyl products remain in contact with the TV for a long time, a stain may result.

If the cabinet becomes dirty, clean it with a soft, dry cloth.

When cleaning the surface of the LCD display, wipe the panel surface gently with a soft, dry cloth.



2) Periodically disconnect the power plug from the outlet and check it. If dust has collected on the power plug connectors, clean off the dust with a dry cloth.

This dust may cause a fire due to reduced insulation on the plug.



Important information

1) About LCD screen

- If you have the LCD screen facing to the sun, the LCD screen will be damaged. Be aware of locating the TV close to a window or outdoors.
- Never press the LCD screen strongly or scratch it, and never put anything on it. These actions will damage the LCD screen.

2) About cabinet and LCD screen

Never spray volatile compounds such as insecticide on the cabinet and LCD screen. This may cause a discolouration or damage the cabinet and LCD screen.

3) Some pixels of the screen do not light up

The LCD display panel is manufactured using an extremely high level of precision technology, however sometimes some pixels of the screen may be missing picture elements or have luminous spots. This is not sign of malfunction.

4) About Interference

The LCD display may cause interference in image, sound, etc. of other electronic equipment that receives electromagnetic waves (e.g. AM radios and video equipment).

5) About using under the low temperature places

If you use the TV in the room of 0°C or less, the picture brightness may vary until the LCD monitor warms up. This is not a sign of malfunction.

6) About afterimage

If a still picture is displayed, an afterimage may remain on the screen, however it will disappear. This is not a sign of malfunction.

Exemptions

- Toshiba is not liable for any damage caused by fires, natural disaster (such as thunder, earthquake, etc.), acts by third parties, accidents, owner's misuse, or uses in other improper conditions.
- Toshiba is not liable for incidental damages (such as profit loss or interruption in business, modification or erasure of record data, etc.) caused by use or inability to use of product.
- Toshiba is not liable for any damage caused by neglect of the instructions described in the owner's manual.
- Toshiba is not liable for any damage caused by misuse or malfunction through simultaneous use of this product and the connected equipment.

Trademark Information

- HDMI, the HDMI logo, and High-Definition Multimedia Interface are trademarks or registered trademarks of HDMI Licensing LLC in the United States and other countries.

Connecting an aerial

Optimum reception of colour requires a good signal and will generally mean that an outdoor aerial must be used.

The exact type and positioning of the aerial will depend upon your particular area.

Your Toshiba dealer or service personnel can best advise you on which aerial to use in your area.

Before connecting the aerial cable, turn off all main power switches.

**VHF and/or
UHF aerial**

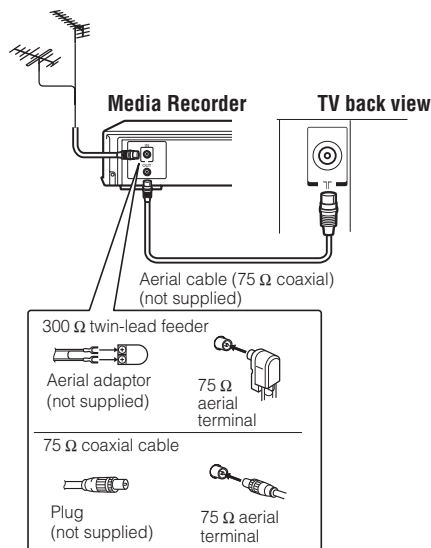

Exploring your new TV

Installing the remote control batteries

Remove the battery cover.

Insert two R03 (AAA) batteries matching the $-/+$ polarities of the battery to the $-/+$ marks inside the battery compartment.

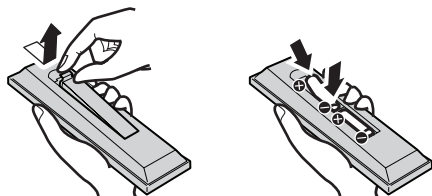

Cautions:

- Dispose of batteries in a designated disposal area. Batteries must not be exposed to excessive heat such as sunshine, fire or the like.
- Attention should be drawn to the environmental aspects of battery disposal.
- Never mix battery types or combine used batteries with new ones.

Notes:

- If the remote control does not operate correctly, or if the operating range becomes reduced, replace both batteries with new ones.
- If the batteries are dead or if you will not use the remote control for a long time, remove the batteries to prevent battery acid from leaking into the battery compartment.

Effective range

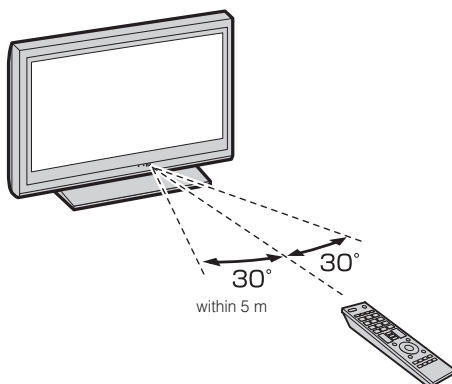

TV front and side panel controls

- You can operate your TV using the buttons on the side panel or the remote control. The back of the panel provide the terminal connections to connect other equipment to your TV (see "Connecting your TV" pages 24 – 29).
- For the use of each control, see the pages in brackets.

TV front view

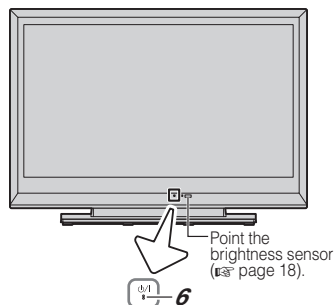

Right side view

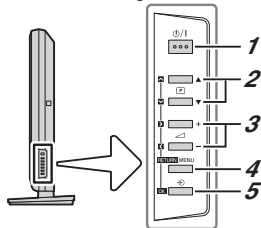

- 1 **⏻/⏻ (Power on/Standby)** — Press to turn the TV on/ standby (☞ page 10).
- 2 **⏮/⏭ (Programme position)** — When no menu is on screen, these buttons select the programme position. (☞ page 12).
⏮/⏭ (MENU up/down) — When a menu is on-screen, these buttons function as up/down menu navigation buttons (except for the input source selection) (☞ page 11).
- 3 **⏪ - + (Volume)** — When no menu is on-screen, these buttons adjust the volume level.
⏪ > (MENU left/right) — When a menu is on-screen, these buttons function as left/right menu navigation buttons or adjust settings (☞ page 11).
- 4 **MENU** — Press to access the menu system (☞ page 11).
RETURN — When a menu is on-screen, this button will take you back to the previous menu (☞ page 12).
- 5 **⏮ (Input source selection)** — When no menu is on screen, this button selects the input source (☞ page 20).
OK — When a menu is on-screen, this button will make a selection or take you to the next available menu layer (☞ page 11).
- 6 **⏻/⏻ (Power LED)** — Power indicator (☞ page 10).

TV back panel connections

TV back view

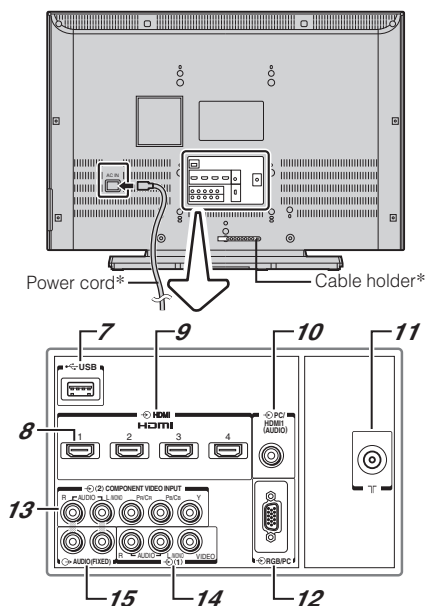

Power cord *

- * Make sure to insert the plugs firmly, when plugging the AC power cord into the TV set end and wall outlet end.
- * Make sure to hold the plug, when unplugging the AC power cord.
- * Never use other cord except for supplied AC power cord, and never use the supplied power cord for any other purpose.
- * The exact power cord will vary according to the country.

Cable holder *

- * You can use the cable holder to hold the aerial cable, video and audio cables etc.
Never grasp the holder when moving the TV.

- 7 **USB (input terminal)** — Insert your USB storage device here to view photos (JPEG) (☞ page 28).
- 8 **⏮ HDMI1 (input terminal)** — High-Definition Multimedia Interface input receives digital audio and uncompressed digital video from an HDMI device or uncompressed digital video from a DVI device (☞ pages 25, 26).
- 9 **⏮ HDMI2 – ⏮ HDMI4 (input terminal)** — High-Definition Multimedia Interface input receives digital audio and uncompressed digital video from an HDMI device (☞ page 25).

- 10** **PC/HDMI1 (AUDIO) (input terminal)** — PC audio input terminal is shared with HDMI1 analogue audio input terminal, and their use can be configured in the **SETUP** menu (pages 25, 26).
- 11** **(Aerial input terminal)** — Analogue aerial signal input (page 7).
- 12** **RGB/PC (input terminal)** — For use when connecting a personal computer (PC) (page 26).
- 13** **(2) (Video 2 input terminals)** — High-definition component video and standard (analogue) stereo audio inputs (page 24).
- 14** **(1) (Video 1 input terminals)** — Standard (composite) video and standard (analogue) stereo audio inputs (page 24).
- 15** **AUDIO (output terminals)** — Standard audio outputs (FIXED) (page 24).

Learning about the remote control

Location of controls

- 1** Picture Size (page 15)
- 2** Subtitle on/off (page 22)
- 3** Input source selection (TV, , , HDMI1- 4, PC) (page 20)
- 4** Power on/Standby (page 10)
- 5** Picture still (page 16)
- 6** Stereo/Bilingual selection (pages 18, 19)
- 7** Number buttons (0-9) (pages 12, 19, 22)
- 8** To display the Channel List (page 21)
- 9** To return to the previous programme (page 12)
- 10** • To display on-screen information (page 12)
- Initial/Index function for Teletext (page 22)
- 11** Sound Mute (This button turns the sound off/on.)
- 12** Programme position (page 12)
- 13** Volume — + (These buttons adjust the volume level.)
- 14** **EXIT** (page 12)
- 15** To access the Quick Menu (page 11)
- 16** Teletext on/Superimpose Teletext/off (page 21)
- 17** • Menu (page 11)
- **OK** (page 11)

- 18** To return to the previous menu (page 12)
- 19** **MENU** (page 11)
- 20** Teletext control buttons (Four coloured buttons : Red, Green, Yellow, Blue) (pages 21, 22)
- 21** To reveal concealed text (page 22)
- 22** • To select a page while viewing a normal picture (page 23)
- To select the time display (page 23)
- 23** To hold a wanted page (page 23)
- 24** To enlarge the teletext display size (page 23)

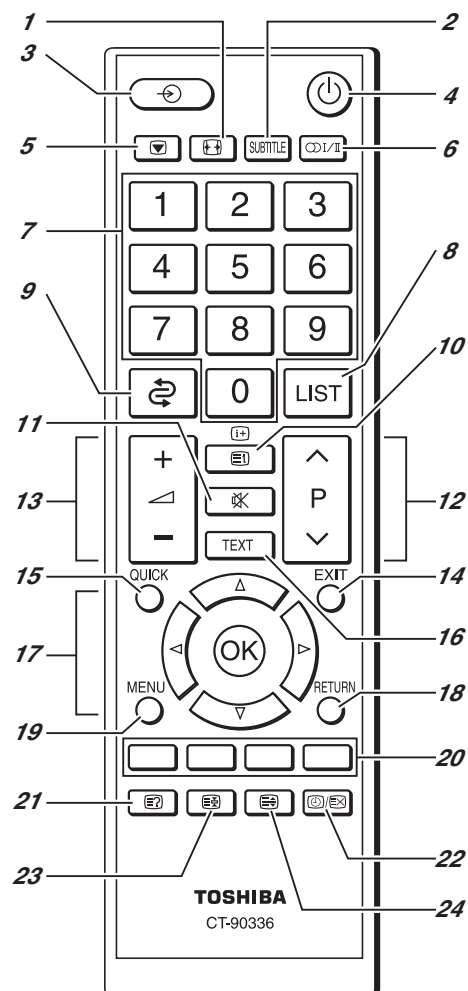

Turning the TV on

Switching on the TV

Connect the power cord to a wall outlet, the O/I power indicator lights in red (standby mode).

- 1 Press O on the remote control or O/I on the TV right side panel, the O/I power indicator lights in green.

Note:

If you watch black and white programmes when the **Colour System** mode is set to Auto, colour noise may appear on the screen. In this case select the appropriate **Colour System** (For the system of each country or region, refer to pages 13, 31).

Switching off the TV

- 1 Press O on the remote control or O/I on the TV right side panel to switch to the standby mode.

Notes:

- When the TV will not be used for a long period of time, such as during vacation or travel, remove the power plug from the wall outlet.
- The TV will automatically turn itself off after approximately 15 minutes if it is tuned to a vacant channel or a station that completes its broadcast for the day. This function does not work in external input or Blue screen Off mode. The TV will automatically turn itself off after approximately 2 hours if you do not operate the TV after turned on by on timer function.
- If power is cut off while you are viewing the TV, the Last Mode Memory function turns on the TV automatically when power is applied again. If power is going to be off for a long time and you are going to be away from your TV, unplug the power cord to prevent the TV from turning on in your absence.

Tuning the TV for the first time

Before switching on the TV, put your decoder and media recorder to standby, if they are connected, and ensure that the aerial is connected. To setup the TV, use the buttons on the remote control as detailed on page 9.

- 1 Press the O button. The **Quick Setup** screen will appear. This screen will appear the first time that the TV is switched on.



- 2 Press O or O to select the menu language (English, Chinese (CS), Malay, Thai, Vietnamese, Russian, Arabic, Persian or French).
- 3 Press OK , to display the **Location** menu (page 13). Press O or O to select **Store** or **Home**. For normal home use, select **Home**.

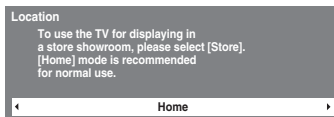

Store mode:

AutoView menu is not available.

- 4 Press OK to display the **AutoView** menu (page 16). Press O or O to select **Yes** or **No**.

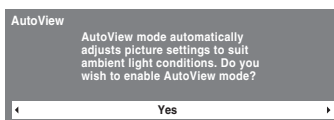

- 5 Press OK to display the **Auto Signal Booster** menu (pages 12, 13), and then O or O to select **Yes** or **No**.

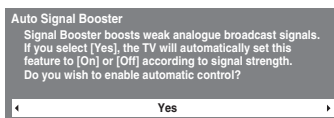

Yes mode :

This function performs automatic distinction of On or Off.

- 6 Press OK to display the **Auto Tuning** startup screen. Press OK to start the automatic search.



When the automatic search is completed, the TV will automatically appear the **Manual Tuning** menu (page 13).

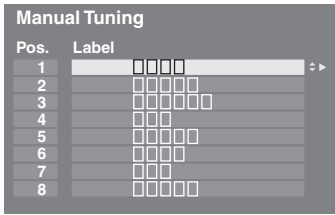

7 Closing the **Quick Setup** menu, press **EXIT**.

Note:

The **Quick Setup** menu can also be display at any time from the **SETUP** menu.

Using the Quick Menu

Quick Menu helps you access some options quickly, such as **Picture Mode**, **Picture Size**, **Sleep Timer** etc.

Press **QUICK** to display the **Quick Menu** and use ∇ or \triangle to select the option.

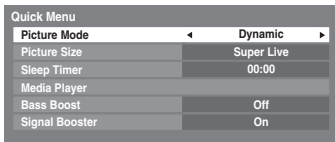

Note:

Quick Menu items are different depending on the current mode.

Mode	Quick menu item	Description
When viewing a TV programme or pictures from the external input	Picture Mode	➤ page 16.
	Picture Size	➤ page 15.
	Sleep Timer	➤ page 19.
	Media Player	➤ page 28.
	Bass Boost	➤ page 19.
When using Media Player (Photo View)	Signal Booster	➤ page 13.
	Interval Time	➤ page 28.
	Repeat	➤ page 28.

Learning about the menu system

We suggest you familiarize yourself with the display charts before using the menu system:

- Press **MENU** to display menu, then press \triangleleft or \triangleright to select main menu headings.
- Press ∇ or \triangle to select an item.
- Press \triangleleft or \triangleright to select or adjust setting.
- Press **(OK)** to display the next menu.

Displaying the menu chart

PICTURE

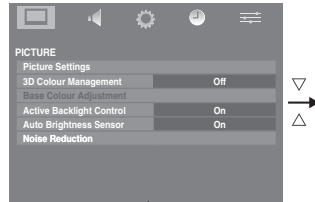

SOUND

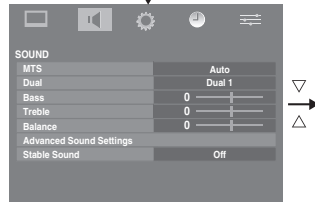

SETUP



TIMER

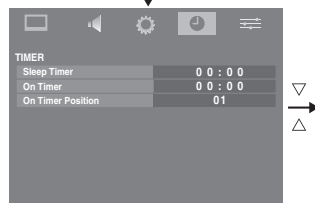

FUNCTION

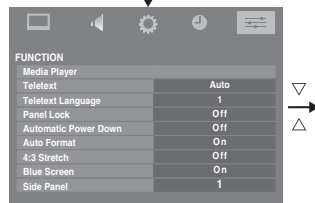

Notes:

- In the video input mode (⊖1, ⊖2 and HDMI), **Auto Tuning** and **Manual Tuning** are not available. Instead, **Manual Settings** appears in the **SETUP** menu (see page 20).
- If you connect external equipment via component video source to external input, **Colour System** selection in the **Manual Settings** menu is not available.
- If you do not make a selection for a while, the menu display disappears automatically.
- If you want to close the menu display instantly, press **EXIT** or **MENU**.
- To return to the previous menu, press **RETURN**.
- In the PC input mode, **PC Settings** appears in the **SETUP** menu (see page 27).
- In the 480i, 576i or 1080i input signals mode, you can select the **Cinema Mode** in the **Picture Settings** menu (see page 17).
- When you use the colour management function (see page 18), you can select the **Base Colour Adjustment** in the **PICTURE** menu.

Watching TV programmes

Selecting the menu language

Choose from 9 different languages (English, Chinese (CS), Malay, Thai, Vietnamese, Russian, Arabic, Persian or French) for the on-screen display.

- 1 Press **MENU**, then press ◀ or ▶ to display **SETUP** menu.
- 2 Press ▼ or ▲ to select **Language**.
- 3 Press ◀ or ▶ to select the desired language.

Changing the position

- 1 Enter the desired position number using the **Number** buttons on the remote control. For positions below 10, use 0 and the required number e.g., for position 1.
- 2 You can also change the position by using **P▲** or **P▼**.
The position will be displayed on the screen with the Mono/Stereo/Dual audio status.

Note:

Changing positions between different format channels takes several seconds.

Switching between two positions

You can switch two positions without entering actual position number each time.

- 1 Select the first position you want to view.

- 2 Select the second position with the **Number** buttons (0-9).
- 3 Press **↔**. The previous channel will be displayed.

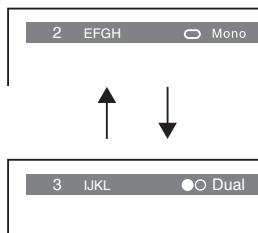

Each time you press **↔**, the TV will switch back and forth between the two positions.

Displaying the on-screen information

- 1 Press **⊞** to display the following on-screen information.



The information will disappear in 6 seconds.

- Position or external input mode selected
- Position skip on/off information
- Label (if set)
- Mono/Stereo/Dual audio status

- 2 To erase the display instantly, press **⊞** again.

Programming channels into the TV's channel memory

- First, use the **Auto Tuning** function to preset all the active channels in your area automatically. Then, arrange the preset channels with the **Manual Tuning** function so that you can tune into only desired channels.
- Use the **Manual Tuning** operation if desired channels cannot be preset with the **Auto Tuning** or if you would like to preset channels to specific position numbers one by one.

Auto Tuning

- 1 From the **SETUP** menu, press ▼ or ▲ to select **Auto Tuning**.
- 2 Press **OK** to display the **Auto Signal Booster** menu (see pages 10, 13), press ◀ or ▶ to select **Yes** or **No**.

- 3 Press **OK** to display the **Auto Tuning** menu.

Auto Tuning
Previous settings will be Lost!
Press EXIT for no change.
Press OK key to start auto tune.

- 4 Press **OK** to start the automatic search.
The search will begin for all available stations.

- 5 When the automatic search is completed, the TV will automatically appear the **Manual Tuning** menu.

- 6 Closing the **Auto Tuning** menu, press **EXIT**.

Note:

When you preset the channel which sound of broadcast transmission system adopts "M" system, the sound system may not be tuned correctly if the radio waves transmit badly. At that time, preset the channel by **Manual Tuning**. The countries such as Myanmar, Brazil, Chile, Colombia apply to this case. See page 31 for more details.

Manual Tuning

- 1 From the **SETUP** menu, press ∇ or Δ to select **Manual Tuning**.
- 2 Press **OK** to display the **Manual Tuning** menu.
Press ∇ or Δ to select the programme position you want to arrange.
- 3 Press **OK** to display the breakdown menu.
Press \leftarrow or \rightarrow to select an item, then press ∇ or Δ to select the item as shown below.

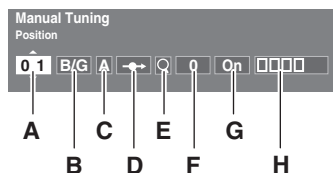

- A. Position selection
- B. System (Sound) (page 31)
- C. Colour System (page 31)

A : Automatic (factory set), **P :** PAL,
S : SECAM, **4 :** NTSC 4.43 (MHz),
3 : NTSC 3.58 (MHz)
If the colour of a certain channel is abnormal, the automatic colour system selection (A) may have malfunctioned, or sound system selection is wrong. In such a case, select another colour and/or sound system (page 31).

D. Position skip selection

Press ∇ or Δ to turn the position skip option on “ \rightarrow ” or off “ \leftarrow ”.
The position will then be skipped when you select channels with **P \wedge** or **P \vee** .
The “ \rightarrow ” mark will appear beside a position number when you use the **Number** button on the remote control.

E. Channel search operation

Press Δ to search up the band or ∇ to search down the band.
Press ∇ or Δ repeatedly until your desired channel is displayed.
When a station is found, it will be displayed.
NEVER PRESS ANY OTHER BUTTONS WHILE THE SET IS TUNING.

F. Manual Fine Tuning

Press ∇ or Δ until better picture and sound are obtained.

G. Signal Booster

If the receiving signal is weak/strong and the picture is noisy, the picture may be improved when using this function.
Press the ∇ or Δ to turn the **Signal Booster On or Off**.

H. Label

Station labels appear under the programme position display each time you turn on the TV, select a channel, or press **[+]**.

To change or create station labels:

- 1) Press ∇ or Δ repeatedly to select a character for the first space, then press \leftarrow or \rightarrow .

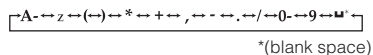

- 2) Repeat step 1) to enter the rest of the characters. If you would like a blank space in the label name, you must choose a blank space from the list of characters.

Press **OK** to store your settings.

Setting the Location

You can select either **Home** or **Store** mode.
Home is recommended for normal home use.
Select **Store** when using a TV for displaying in a shop, etc.

- 1 From the **SETUP** menu, press ∇ or Δ to select **Location**.
- 2 Press \leftarrow or \rightarrow to select **Home** or **Store**.

Sorting positions

- The TV is capable of receiving a number of different channels depending upon where you live.
- Sorting programme position is an easy way of storing each channel on the programme position of your choice.

Ex.: To swap channel ABCD (Prog.1) for channel MNOP (Prog.4):

- 1 From the **SETUP** menu, press ∇ or \triangle to select **Manual Tuning** menu, and then press **OK**.
- 2 Press ∇ or \triangle to select the channel **ABCD**, then press \triangleright .

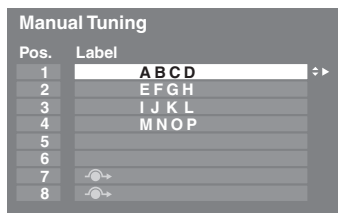



- 3 Press ∇ to select the new position "4", then press \triangleleft .
- 4 Press \triangle to select the channel **MNOP**, then press \triangleright .
- 5 Press \triangle to select the new position "1", then press \triangleleft .
- 6 Confirm new **Manual Tuning** menu.

Using the TV's features

Picture adjustment

- Most of the picture controls and functions are available. However features not available will be greyed out.

Selecting the Picture Size

- 1 Press  until the **Picture Size** list appears on the screen, then press ∇ or Δ to select the appropriate **Picture Size** (or press  repeatedly to select the desired **Picture Size** directly).

AV format

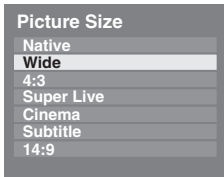

- 2 Press .

Wide

Use this setting when watching a wide-screen DVD, widescreen video tape or a 16:9 broadcast (when available). Due to the range of wide-screen formats (16:9, 14:9, 20:9 etc.), you may see bars on the top and bottom of the screen.

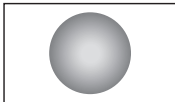

4:3

Use this setting to view a true 4:3 broadcast.

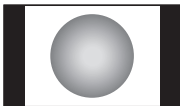

Super Live

This setting will enlarge a 4:3 image to fit the screen by stretching the image horizontally and vertically, holding better proportions at the centre of the image. Some distortion may occur.

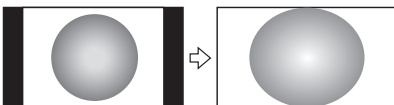

Cinema

When watching "all sides panel format" films/video tapes, this setting will eliminate or reduce the black bars on all the sides of the screen by zooming in and selecting the image without distortion.

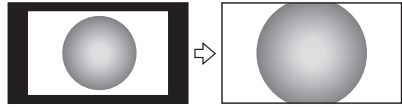

Subtitle

When subtitles are included on a letterbox format broadcast, this setting will raise the picture so that the most of text is displayed.

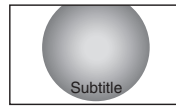

14:9

Use this setting when watching a 14:9 broadcast.



Native

This setting will display the image correctly without distortion or picture clipping.

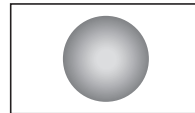

PC Normal

Use this setting for PC connected via HDMI or RGB/PC terminal when receiving PC signal format. This setting will display the image correctly without distortion or picture clipping.

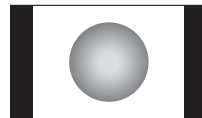

PC Wide

Use this setting for PC connected via HDMI or RGB/PC terminal when receiving PC signal format. This setting will display the image without picture clipping.

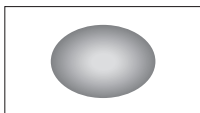

Dot by Dot

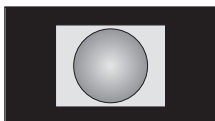

"Dot by Dot" is a non-scaling display. Depending on the input signal format, the picture is displayed with side panels and/or bars at the top and bottom (i.e. VGA input source).



Notes:

- In the PC connected via HDMI or RGB/PC terminal (see page 26), the picture size selection is **PC Wide**, **PC Normal** or **Dot by Dot** only.
- Using the special functions to change the size of the displayed image (e.g. changing the height/width ratio) for the purpose of public display or commercial gain may infringe on copyright laws.
- If the aspect ratio of the selected format is different from the one of the TV transmission or video programme, it can cause a difference in vision. Change to the correct aspect ratio picture size.
- When using the PC connected via HDMI or RGB/PC terminal, the moving image quality may be deteriorated.

Using the picture still

- Press  to freeze the picture. Even if an image is frozen on the TV screen, the pictures are running on the input source. Audio continues to be output as well. To return to a moving picture, press  again.

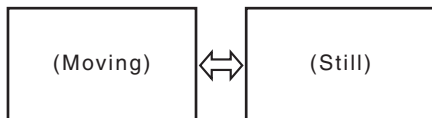

Note:

If you use this function except for the purpose of your private viewing and listening, it may infringe the copyright protected by the copyright laws.

Adjusting the Picture Position

Adjustment to the position of the picture may be made to suit your viewing preferences.

- 1 From the **SETUP** menu, press ∇ or \triangle to select **Picture Position**.
- 2 Press , then press ∇ or \triangle to select the item you want to adjust.

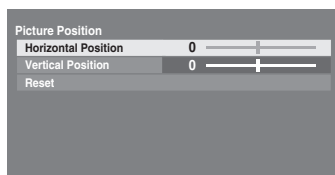

- 3 Press \triangleleft or \triangleright to adjust the settings as desired.



Notes:

- When the picture size is in **Wide** or **4:3** mode, only the **Horizontal** position can be adjusted.
- When the picture size is in **Native**, **PC Wide**, **PC Normal** and **Dot by Dot** mode, none of this function will be available.

Resetting the Picture Position

This function resets your **Picture Position** settings to the factory settings.

- 1 From the **Picture Position** menu, press ∇ or \triangle to select **Reset**.
- 2 Press .

Activating the Picture Mode

This TV offers the choice of personalising the picture style.

AutoView, **Dynamic**, **Standard**, **Mild**, **Movie**, **Game** and **PC** are preset options and affect many features/settings within the TV.

Notes:

- Because the **AutoView** mode automatically adjusts picture settings based on ambient light conditions, the **Auto Brightness Sensor** is greyed out when it is selected.
- **Game** mode is available in external input mode (other than aerial input). When you select **Game** mode, suitable widescreen formats will be selected.
- **PC** mode is available in RGB/PC input mode or HDMI input mode.

- 1 From the **PICTURE** menu, press ∇ or \triangle to select **Picture Settings**.
- 2 Press , then press ∇ or \triangle to select **Picture Mode**.

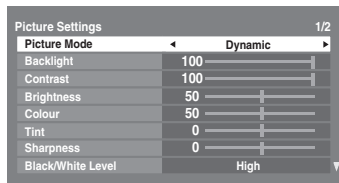

- Press ◀ or ▶ to select the picture mode you prefer and press **OK**.

Activating the picture preferences

You can customise current picture mode settings as desired. For example, while selecting "Dynamic," if you change the following items, such as **Picture Settings** items, your new setting is saved as **Dynamic-user**.

- From the **Picture Settings** menu, press ▼ or ▲ to select either **Backlight**, **Contrast**, **Brightness**, **Colour**, **Tint** or **Sharpness** and press **OK**.
- Press ◀ or ▶ to adjust the settings.

Setting the Black/White Level

Black/White Level improves the contrast of the picture.

- From the **Picture Settings** menu, press ▼ or ▲ to select **Black/White Level**.
- Press ◀ or ▶ to select **High**, **Off**, **Low** or **Middle**.

Using the Cinema Mode

A movie film's picture runs at 24 frames a second, whereas movie software such as DVD, etc., that you enjoy watching on TV at home runs at 30 (NTSC) or 25 (PAL) frames a second. To convert this signal to reproduce a smooth motion and picture quality, select the **On** mode.

Effective signal and setup conditions:

- When the Video input mode is selected.
- When the input signal format is 480i, 576i or 1080i signals.

- From the **Picture Settings** menu, press ▼ or ▲ to select **Cinema Mode** on the 2nd page.



- Press ◀ or ▶ to select **On** or **Off**.

Note:

When a DVD movie with subtitle is playing back, this mode may not work correctly.

Adjusting the Colour Temperature

Colour Temperature increases the warmth or coolness of the picture by setting the red, green or blue tint.

- From the **Picture Settings** menu, press ▼ or ▲ to select **Colour Temperature** on the 2nd page, then press **OK**.
- Press ◀ or ▶ to select **Cool**, **Natural**, or **Warm** to suit your preference.

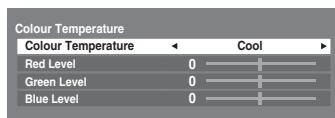

- Press ▼ or ▲ to select **Red Level**, **Green Level** or **Blue Level**, then press ◀ or ▶ to adjust the setting as required.

Resetting the Picture Settings

- From the **Picture Settings** menu, press ▼ or ▲ to select **Reset** on the 2nd page, then press **OK**.

Activating the Noise Reduction (NR)

If the receiving signal of MPEG is a mosquito (grained) noise depending on the compression and conversion, the picture is weak and the picture is blurry, the picture may be improved when using this function.

- From the **PICTURE** menu, press ▼ or ▲ to select **Noise Reduction**, and then press **OK**.



- Press ▼ or ▲ to select **Auto NR**, and then press ◀ or ▶ to select **On** or **Off**.

Off mode :

MPEG NR menu and **DNR** menu are available.

- MPEG NR** mode: **Low**, **Middle**, **High** or **Off**
- DNR** (Digital Noise Reduction) mode: **Low**, **Middle**, **High** or **Off**

Note:

DNR function is available for 480i and 576i signals.

Adjusting the Colour Management

You can adjust the picture colour quality by selecting from 6 base colour adjustments : **Red**, **Green**, **Blue**, **Yellow**, **Magenta** or **Cyan**.

- 1 From the **PICTURE** menu, press ∇ or \triangle to select **3D Colour Management**.
- 2 Press \triangleleft or \triangleright , then press \triangleleft or \triangleright to select **On**.
- 3 Press \odot , then press ∇ or \triangle to select **Base Colour Adjustment**.
- 4 Press \odot , then press ∇ or \triangle to select an item you want to adjust.

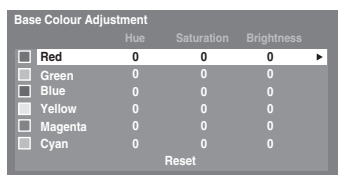

- 5 Press \triangleright , then press \triangleleft or \triangleright to select **Hue**, **Saturation** or **Brightness**.
- 6 Press ∇ or \triangle to adjust the settings as required.



Resetting the Base Colour Adjustment

The reset function adjusts the base colour adjustment to the factory settings.

- 1 From the **Base Colour Adjustment** menu, press ∇ or \triangle to select **Reset**.
- 2 Press \odot .

Using the Active Backlight Control

In order to improve screen visibility, the **Active Backlight Control** sets the screen brightness automatically during dark scenes.

- 1 From the **PICTURE** menu, press ∇ or \triangle to select **Active Backlight Control**.
- 2 Press \triangleleft or \triangleright to select **On** or **Off**.

Activating Auto Brightness Sensor

When the **Auto Brightness Sensor** is activated, it will automatically optimise the backlighting levels to suit ambient light conditions.

- 1 From the **PICTURE** menu, press ∇ or \triangle to select **Auto Brightness Sensor**.

- 2 Press \triangleleft or \triangleright to select **On** or **Off**.

Sound adjustment

Setting the MTS (Multi-channel TV Sound)

Auto mode

The **MTS Auto** mode automatically recognize stereo/bilingual programmes depending on the broadcast signal.

- 1 Press **MENU**, and then press \triangleleft or \triangleright to display the **SOUND** menu.
- 2 Press ∇ or \triangle to select **MTS**, and then press \triangleleft or \triangleright to select **Auto** or **Mono**.

Mono mode

If you experience noise or poor reception of any stereo/bilingual programme, set the **MTS** mode to **Mono**.

Noise will be reduced and reception may improve.

Note:

*If you experience noise with a particular programme on whose channel reception is usually good, try setting MTS mode to **Auto**, then switch \odot to \square Mono (monaural).*

Selecting the Dual 1 or Dual 2 mode

You can hear only **Dual 1** or **Dual 2** sound selected, whenever bilingual programmes are received.

- 1 Press **MENU**, and then press \triangleleft or \triangleright to display the **SOUND** menu.
- 2 Press ∇ or \triangle to select **Dual**, and then press \triangleleft or \triangleright to select **Dual 1** or **Dual 2**.

Notes:

- When the MTS setting is in **Mono** mode, the **Dual** menu is not selectable.
- The **Dual** menu setting status remains even if the TV is turned off.

Selecting the stereo programmes

- 1 When a stereo programme is received, \odot **Stereo** appears.



- 2 Press \odot to select the stereo/monaural mode. \odot **Stereo** and \square **Mono** appear cyclically on the screen.

 Stereo

Selecting the bilingual programmes

- 1 When a bilingual programme is received, ● **Dual** appears.
- 2 Press  to select the sound to be heard. The sound differs according to the transmission system: NICAM or German stereo/bilingual broadcast.



Display	Sound to be heard	
	NICAM	German stereo/ bilingual broadcast
● Dual 1	Sub I sound	Main sound
● Dual 2	Sub II sound	Sub sound
○ Mono	Main sound	—

Note:

These settings are not stored in the TV memory.

Selecting the monaural programmes

If sound distortion, interruptions or silence arises in the low sound volume level, setting the  **Mono 2** mode will mitigate the problem.

- 1 When a monaural programme is received, ○ Mono appears.
- 2 Press  to select a monaural mode that is easy to hear.  **Mono 1** and  **Mono 2** appear cyclically to the screen.

Note:

On some cases, the reception of stereo/bilingual broadcasts may not be possible after switching on the  **Mono 2** mode.

Adjusting the sound quality

- 1 From the **SOUND** menu, press ∇ or Δ to select an item you want to adjust.
- 2 Press \triangleleft or \triangleright to adjust the settings as required.

Selection	\triangleleft	Pressing	\triangleright
Bass	weaker		stronger
Treble	weaker		stronger
Balance	decreases the right channel		decreases the left channel

Using the Advanced Sound Settings

Bass Boost helps to create rich bass.

Voice Enhancement helps to emphasize dialogue. It will be easier to hear voices over other background audio.

- 1 From the **SOUND** menu, press ∇ or Δ to select **Advanced Sound Settings**, and then press .
- 2 Press ∇ or Δ to select the item you want to adjust.

Advanced Sound Settings	
Voice Enhancement	On
Bass Boost	Off

Voice Enhancement : To turn the vocal emphasis effect **On** or **Off**.

Bass Boost : To select the desired bass expansion level **On** or **Off**.

Using the Stable Sound

The **Stable Sound** function limits the highest volume level to prevent extreme changes in volume when the signal source changes (for example, to prevent the sudden increase in volume that often happens when a TV programme switches to a commercial).

- 1 From the **SOUND** menu, press ∇ or Δ to select **Stable Sound**.
- 2 Press \triangleleft or \triangleright to select **On** or **Off**.

Note:

The **Stable Sound** effect is active only when the sound outputs from the speaker.

Other features settings

Selecting the TIMER menu

The Timer is especially useful if you want the TV to turn itself on or off after a selected period of time.

- 1 Press **MENU**, and then press \triangleleft or \triangleright to display the **TIMER** menu.
- 2 Press ∇ or Δ to select the required timer mode (**Sleep Timer** (Turn off the TV) or **On Timer**).
- 3 Press the **Number** buttons (0-9), \triangleleft or \triangleright to set the On or Off delay time. The timer display will set by 10 minutes, up to 12 hours and 50 minutes.

- 4** When setting the On timer, press ∇ or \triangle to select the **On Timer Position** and enter the program position number you want to watch. Press **EXIT** to exit the menu. Set the Standby mode by pressing \odot on the remote control.

Note:

The TV will automatically turn itself off after approximately 2 hours if you do not operate the TV after turned on by on timer function.

Using the Auto Format

When the TV receives a true HDMI signal picture and the **Auto Format** is **On**, it will automatically be displayed in HDMI signal format, irrespective of the TV's previous setting.

- 1** Press **MENU**, then press \triangleleft or \triangleright to display the **FUNCTION** menu.
- 2** Press ∇ or \triangle to select **Auto Format**, then press \triangleleft or \triangleright to select **On** or **Off**.

Activating Blue Screen

With the **Blue Screen** function **On**, the screen will automatically turn blue and the sound will be muted (except for PC input) when no signal is being received.

- 1** From the **FUNCTION** menu, press ∇ or \triangle to select **Blue Screen**.
- 2** Press \triangleleft or \triangleright to select **On** or **Off**.

Note:

In the PC input mode or Teletext mode (see page 21), this function is not available.

Setting the Automatic Power Down

The TV will automatically turn itself off (standby) after approximately 4 hours, if you don't touch the control buttons on the remote control or on the TV control panel.

- 1** From the **FUNCTION** menu, press ∇ or \triangle to select **Automatic Power Down**.
- 2** Press \triangleleft or \triangleright to select **On** or **Off**.

Panel Lock

Panel Lock disables the buttons on the TV. All buttons on the remote control can still be used.

- 1** From the **FUNCTION** menu, press ∇ or \triangle to select **Panel Lock**.
- 2** Press \triangleleft or \triangleright to select **On** or **Off**.

Note:

When **Panel Lock** is **On**, a reminder will appear when the buttons on the TV are pressed.

If the standby button is pressed, the TV will switch off and can only be brought out of standby by using the remote control.

Activating the 4:3 Stretch

When **4:3 Stretch** is activated, this function will switch 4:3 format programmes into a full screen picture.

- 1** From the **FUNCTION** menu, press ∇ or \triangle to select **4:3 Stretch**.
- 2** Press \triangleleft or \triangleright to select **On** or **Off**.

Note:

In HDMI signal format, this function is available.

Adjusting the brightness of Side Panel

You can adjust the brightness of **Side Panel** in 14:9 or 4:3, etc. mode.

- 1** From the **FUNCTION** menu, press ∇ or \triangle to select **Side Panel**.
- 2** Press \triangleleft or \triangleright to adjust the settings as required.

Selecting the video input source to view

- 1** Press \odot on the remote control until the video input mode list appears on the screen, then press ∇ , \triangle or \odot to select appropriate input source (or press \odot on the TV right side panel to select required input source directly).

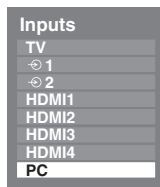

- 2** Press **OK**.
 - \odot 1 (with a video icon) (1), video 1 input),
 - \odot 2 (with a video icon) (2), component video input),
 - HDMI1, HDMI2, HDMI3, HDMI4 (HDMI input),
 - PC (with a computer icon) RGB/PC, PC input)

Setting the Manual Settings menu

- 1** Press **MENU**, then press \triangleleft or \triangleright to display the **SETUP** menu.
- 2** Press ∇ or \triangle to select **Manual Settings**, then press **OK**.

- 3 Press ◀ or ▶ to select an item, and then press ▼ or ▲ to select the item as shown below.

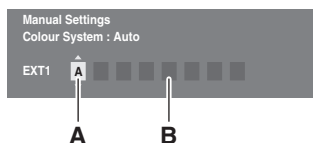

A. Colour System

Confirm that **Colour System** is set to "A" (Auto). If not, select "A" with ▼ or ▲.

Note:

Only 1 signal input, this function is available.

B. Label

The label allows you to label each input source for your TV.

To change or create labels:

- 1) Press ▼ or ▲ repeatedly to select a character for the first space, then press ◀ or ▶.

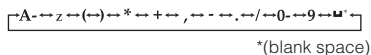

- 2) Repeat step 1) to enter the rest of the characters. If you would like a blank space in the label name, you must choose a blank space from the list of characters.

Press (OK) to store your settings.

Channel List

- 1 Press the (LIST) button. The **Channel List** will appear.
- 2 Press ▼ or ▲ to select a channel, and press (OK) to watch.

Teletext

This TV has a multi-page Teletext memory, which takes a few moments to load and it offers two ways of viewing **Teletext Auto** and **List** which are explained below.

Setting up the Teletext mode

To select a language for Teletext:

The language 1-4 option enables the display of different language when using **Teletext**.

- 1 From the **FUNCTION** menu, and then press ▼ or ▲ to select **Teletext Language**.
- 2 Press ◀ or ▶ to select the required language.

- **Language 1:** English, German, Dutch, Flemish, Russian, Bulgarian, Ukranian, Lettish, Lithuanian, Czech, Slovak, Estonian
- **Language 2:** Polish, German, Dutch, Flemish, Estonian, Lithuanian, French, Serbian, Croatian, Slovenian, Czech, Slovak, Rumanian
- **Language 3:** English, French, Hebrew, Turkish, Arabic
- **Language 4:** English, French, Hebrew, Turkish, Farsi (Iranian/Persian)

To select Teletext mode:

Select a channel position with the desired Teletext service.

- 1 From **FUNCTION** menu, press ▼ or ▲ to select **Teletext**.
- 2 Press ◀ or ▶ to select **Auto** or **List** mode.

Note:

When you are watching the teletext programme, **SETUP** menu and **FUNCTION** menu are not selectable.

Teletext general information

(TEXT) button:

Pressing (TEXT) once will bring up the teletext screen. Press again to superimpose the teletext over a normal broadcast picture. Press again to return to normal TV mode. You need to return to normal viewing if you wish to change channels. When you first press (TEXT) to access the text service, the first page you see will be the initial page.

In **Auto** mode, this displays the main subjects available and their relevant page numbers.



In **List** mode, you will see the page numbers currently stored on the **each colour** button.

Note:

If you press  while the Picture Mode is activated, this mode will be cancelled.

Sub-pages:

Once in this chosen page, if there are sub-pages they will automatically load into memory without changing the one you are reading. If there are many sub-pages, it will take a long time for them all to load and this will depend on the speed with which the broadcaster transmits them.

To access the sub-pages in memory, press  or  to view them.

Using Subtitles

- 1 Press  on the remote control to display the current Subtitle status. While this status is displayed, press again to change the setting.

Note:

If **Subtitle** is On, the TV will always display subtitles whenever such information is available for the channel you are viewing.

Using Auto mode

There are two Modes: **Auto** will display FASTEXT, if available. **List** will display your four favorite pages. In either mode, as an alternative to the coloured buttons, you can access a page by entering a 3-digit number, using the **Number** buttons on the remote control, or to advance to the next page, press **P**^, to go back to the previous page press **P**v. To change between **Auto** and **List**, see above.

- Press  to access teletext.

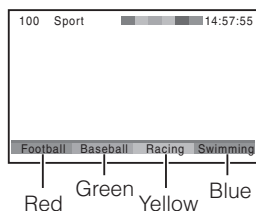

If FASTEXT is available, you will see 4 coloured titles at the base of the TV screen. To access any given subject, simply press the relevant coloured button on the remote control.

If FASTEXT is not available, you can access any page simply by entering a 3-digit page number or pressing the corresponding coloured button.



For further information on your particular text system(s), see the broadcast teletext index page or consult your local Toshiba dealer.

Using List mode

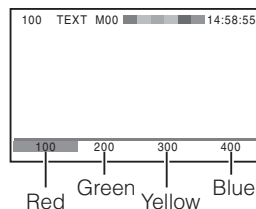
- 1 Press  to access teletext.



The four choices at the bottom of the screen are now number – **100, 200, 300** and **400**, which have been programmed into the TV's memory.

- 2 To view these pages, use the coloured prompt buttons.
e.g. press the Green button to view page 200.
- 3 If you want to change these stored pages, press the coloured button for the colour you want to change.
e.g. Press the Green button and enter the 3-digit number.
This number will change and blinking.
- 4 Press  to store your choice. The bars at the bottom of the screen will flash white.
- 5 You may view other pages by simply entering the 3-digit page number – but NEVER press  or you will lose the favorite already stored.

Teletext buttons on the remote control

Below is an introduction to the teletext buttons on your remote control and their functions.

 **To display a page of teletext:**

Press  to display teletext. Press again to superimpose the teletext over a normal broadcast picture. Press again to return to normal TV mode.

 **To display an index/initial page:**

In Auto-mode

Press  to access the index page. The one displayed is dependant on the broadcaster.

In List-mode

Press  to return to the 100 page or initial page.

 **To reveal concealed text:**

Some pages cover topics such as quizzes and jokes. To discover the solutions, press .



 **To hold a wanted page:**

This function is included as it is part of the broadcast teletext system but you will not need it as this TV allows you to control the display of sub-pages.

 **To enlarge the teletext display size:**

Press  once to enlarge the top half of the page, press again to enlarge the bottom half of the page. Press again to revert to the normal size.

 **To select a page while viewing a normal picture:**

When in teletext mode, if a page selection is made and then  is pressed, a normal picture will be displayed. The TV will indicate when the page is present by displaying the title bar of the text page at the top of the screen. Press  to view the page.

Note:

It will not be possible to change programme position while in Teletext mode, you will have to cancel the teletext first by pressing  to return to a normal TV picture.

To select the time display:

If you press  while watching a normal TV broadcast, you will see a time display from the broadcaster. It will remain on the screen for about 5 seconds.

9:56 and 25 seconds p.m.

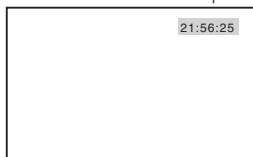

Connecting your TV

Back connections

Connection example

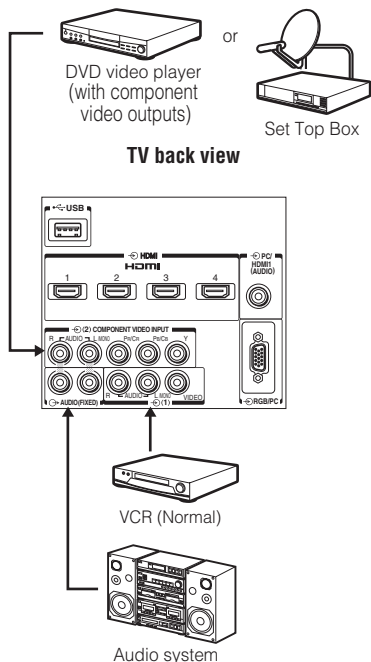

- Before connecting any external equipment, turn off all main power switches.
- The unauthorized recording of TV programmes, DVDs, video tapes and other materials may infringe upon the provisions of copyright law.
- The **COMPONENT VIDEO INPUT** consists of three component video signals (**Y**, **Pb/Cb**, **Pr/Cr**) and provides the best picture performance. These terminals can only be used with the component video compatible equipment e.g. DVD video player, etc.
- Additional equipment and cables shown are not supplied with this TV.

Connecting HDMI or DVI devices

- When turning on your electronic components, turn on the TV first, and then the HDMI and DVI device.
- When turning off your electronic components, turn off the HDMI and DVI device first, and then the TV.
- This TV may not be compatible with features and/or specifications that may be added in the future.

- This TV is only operable with L-PCM on 32/44.1/48 kHz and 16/20/24 bits. If there is no sound when using HDMI, use the analogue audio cables to connect the TV and the HDMI device, and select **Analogue** in **HDMI 1 Audio** of the **AV Connection** menu.
- This TV is able to connect with HDMI devices. But it is possible that some HDMI devices may not operate properly with this TV.

Connecting an HDMI or a DVI device

The HDMI input on your TV receives digital audio and uncompressed digital video from an HDMI device and uncompressed digital video from a DVI device.

This input is designed to accept HDCP programme material in digital from CEA-861-D compliant consumer electronic devices (such as a set top box and DVD player with HDMI and DVI output).

The HDMI input is designed for best performance with 1080i (50 Hz/60 Hz) and 1080p (24/50/60 Hz) high-definition video signals, but will also accept and display 480i, 480p, 576i, 576p, and 720p (50Hz/60 Hz (60 Hz: except for E-EDID)) and VGA (VESA 640 × 480 @ 60/72/75 Hz) signals.

- HDMI: High-Definition Multimedia Interface
- DVI: Digital Video Interface
- HDCP: High-bandwidth Digital Content Protection
- CEA-861-D compliance covers the transmission of uncompressed digital video with high-bandwidth digital content protection, which is being standardized for reception of high-definition video signals. Because this is an evolving technology, it is possible that some devices may not operate properly with the TV.
- E-EDID: Enhanced-Extended Display Identification
- Acceptable PC signal format:
 - S-VGA: VESA 800 × 600 @ 56/60/72/75 Hz
 - XGA: VESA 1024 × 768 @ 60/70/75 Hz
 - W-XGA: VESA 1280 × 768 @ 60/75 Hz
 - W-XGA: VESA 1360 × 768 @ 60 Hz
 - S-XGA: VESA 1280 × 1024 @ 60/75 Hz

However, these signal formats are converted to match the number of pixels of the LCD panel. Therefore, the TV may not display small text properly.

If you connect this unit to your PC, the compressed image is displayed in S-XGA mode, therefore the picture quality may deteriorate and characters may not be read.

- L-PCM: Linear-Pulse Code Modulation

Connecting an HDMI device

One HDMI cable (type A connector)

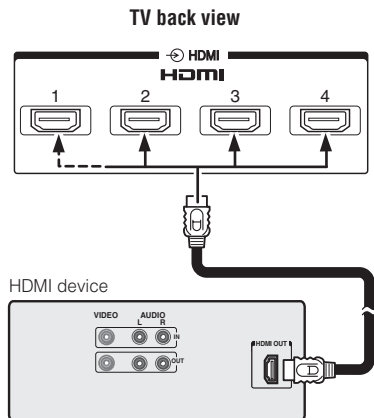

For proper operation, it is recommended that you use a short HDMI cable. HDMI cable transfers both video and audio.

Connecting a DVI device

One HDMI (type A connector)-to-DVI adapter cable and audio cables

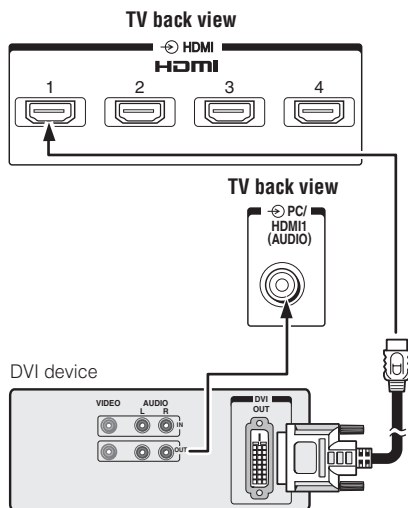

HDMI (type A connector)-to-DVI adapter cable

For proper operation, the length of an HDMI-to-DVI adapter cable should not exceed 3m. The recommended length is 2m.

Standard analogue audio cables

An HDMI-to-DVI adapter cable transfers only video. Separate analogue audio cables are required.

Selecting the PC/HDMI 1 Audio mode

You can select PC audio or HDMI audio when using this function.

- 1 From the **SETUP** menu, and then press ∇ or \triangle to select **AV Connection**.
- 2 Press **OK** to display the **AV Connection** menu.



- 3 Press ∇ or \triangle to select **PC/HDMI 1 Audio**, then press \triangleleft or \triangleright to select **PC** or **HDMI1**.

Setting the HDMI 1 Audio mode

You can select sound of an HDMI or DVI device connected to the HDMI input terminals from three modes:

Auto, Digital or Analogue.

Note:

This function is available only when the PC/HDMI 1 Audio mode is set to HDMI1.

- 1 From the **AV Connection** menu, press ∇ or \triangle to select **HDMI 1 Audio**.
- 2 Press \triangleleft or \triangleright to select **Auto, Digital or Analogue**.

Connecting a computer

To connect a PC to the RGB/PC terminal on the TV:

An analogue RGB (15 pin) computer cable can be connected.

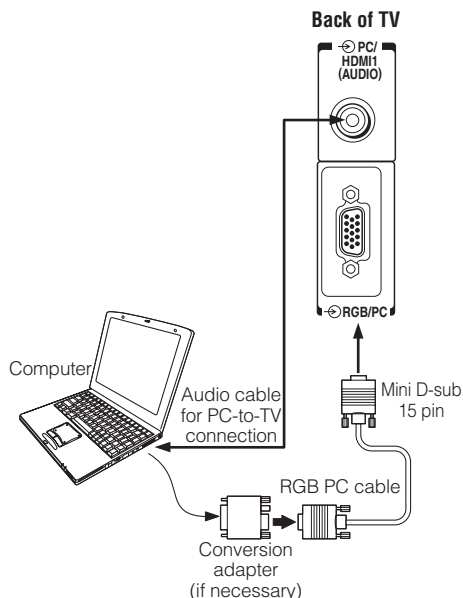

Connect a PC cable from the computer to the **RGB/PC** terminal on the back of the TV.

The following signals can be displayed:

- VGA: VESA 640 × 480 @ 60/72/75 Hz
- S-VGA: VESA 800 × 600 @ 56/60/72/75 Hz
- XGA: VESA 1024 × 768 @ 60/70/75 Hz
- W-XGA: VESA 1280 × 768 @ 60/75 Hz
- W-XGA: VESA 1360 × 768 @ 60 Hz
- S-XGA: VESA 1280 × 1024 @ 60/75 Hz

Notes:

- Some PC models cannot be connected to this TV.
- If connecting a certain PC model that signal is particular, the PC signal may not be detected correctly.
- There is no need to use an adapter for computers with DOS/V compatible mini D-sub 15 pin terminal.
- A bar may appear in the upper, lower, right or left side of the screen, or parts of the picture may be obscured depending on some signals. This is not the malfunction.
- If the edges of the picture are stretched, readjust the picture position adjustments in the **PC Settings** menu.

- Depending on the specification of the PC you are playing the DVD-Video on, and the DVD's title, some scenes may be skipped, or you may not be able to pause during multi-angle scenes.

To connect a PC to the HDMI terminal on the TV:

When connecting a PC to the HDMI terminal on the TV, use an HDMI-to DVI adapter cable and analogue audio cables.

If connecting a PC with an HDMI terminal, use an HDMI cable (type A connector). Separate analogue audio cables are not necessary.

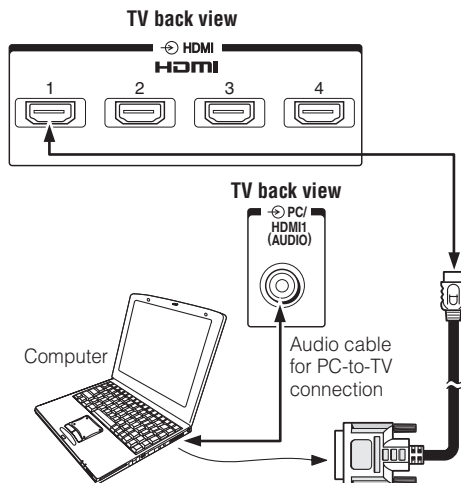

Notes:

- The edges of the images may be hidden.
- If connecting a certain PC model that signal is particular, the PC signal may not be detected correctly.

Signal names for mini D-sub 15 pin connector



Pin assignment for RGB/PC terminal



Pin No.	Signal name	Pin No.	Signal name
1	R	9	NC
2	G	10	Ground
3	B	11	NC
4	NC (not connected)	12	NC
5	NC	13	H-sync
6	Ground	14	V-sync

7	Ground	15	NC
8	Ground		

Using the PC Settings

- Most of the picture controls and functions are available. However features not available will be greyed out.
- First press  until the video input mode list appears on the screen, then press ∇ or \triangle and  in order to select the PC input mode ( page 20).
- This function may not be available for some signal or if no signal is received.
- The optimum points of the **Clock Phase** and **Sampling Clock** adjustments may be incomprehensible according to the input signals.

Adjusting the picture position

- 1 Press **MENU**, then press \triangleleft or \triangleright to display the **SETUP** menu.
- 2 Press ∇ or \triangle to select **PC Settings**.
- 3 Press  to display the **PC Settings** menu.

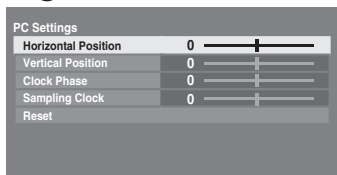

- 4 Press ∇ or \triangle to select an option you want to adjust. Press \triangleleft or \triangleright to adjust the settings as required.

Adjusting the Clock Phase of the picture

If the **Clock Phase**, which synchronize the PC signal and LCD display, is not optimized, the picture will blur. This function enables you to adjust **Clock Phase** and display a clear picture.

- 1 From the **PC Settings** menu, press ∇ or \triangle to select **Clock Phase**.
- 2 Press \triangleleft or \triangleright to obtain a clear picture.

Adjusting the Sampling Clock

If the **Sampling Clock** does not match with the dot clock frequency of the PC, blurred picture detail will occur, or screen width will change, or drift patterns in vertical lines may be apparent. This function enables you to adjust it and optimize the picture.

- 1 From the **PC Settings** menu, press ∇ or \triangle to select **Sampling Clock**.
- 2 Press \triangleleft or \triangleright to optimize the picture.

Resetting the PC Settings

The **Reset** function adjusts the **PC Settings** to the factory settings.

- 1 From the **PC Settings** menu, press ∇ or \triangle to select **Reset**.
- 2 Press .

Note:

When a PC is connected using HDMI none of these function will be available.

Using the Media Player

The TV allows you to enjoy photos stored on a USB device.

Notes:

- Do not insert/remove a USB device while in use.
- **MENU** is not available during playback.

Media Player Specifications

Device

USB device:
USB Mass Storage Class devices (MSC)

Notes:

- Connectivity is not guaranteed for all devices.
- Connect the USB device to the TV directly.
- Do not use a USB hub.

Supported file system

FAT12, FAT16 and FAT32

You must obtain any required permission from copyright owners to download or use copyrighted content. Toshiba cannot and does not grant such permission.

Basic operation

Auto Start:

- 1 From the **FUNCTION** menu, highlight **Media Player** and press **OK**.



- 2 Press **▽** or **△** to highlight **Auto Start**.
- 3 Press **◀** or **▶** to select **On**.
- 4 Insert a USB device into the **USB** terminal on the back of the TV.
- 5 A confirmation message will appear. Highlight **Yes**, and then press **OK**.
- 6 Press **▽** or **△** to select **Photo**, and then press **OK**. The list window of files will appear.
- 7 Press **▽** or **△** to select the USB device if the selection screen is displayed.

Note:

If **Auto Start** is set to **Off**, you can start the Media Player manually.

Manual Start:

- 1 Insert a USB device into the **USB** terminal on the back of the TV.
- 2 From the **FUNCTION** menu, highlight **Media Player**, and then press **OK**.
- 3 Press **▽** or **△** to select **Photo**, and press **OK**. The list of files will appear.
- 4 Press **▽** or **△** to select the USB device if the selection window is displayed.

Viewing JPEG files

To view in Single View mode:

- 1 When the list window appears after starting the Media Player, press **▽** or **△** to select a file or folder.

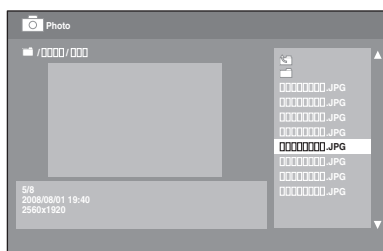

- 2 Press **OK** to begin viewing the selected file or to move to the next layer.

⏪: To return to the previous layer.

- 3 Press **▽** to view the next file, or press **△** to view the previous file.

Note:

If the previous or next file is not compatible, it will be skipped automatically.

To view in Slide Show mode:

- 1 To switch to Slide Show mode, press **OK** during Single View mode.

Note:

To return to Single View mode, press **OK** again.

- 2 Press **▽** to view the next file, or press **△** to view the previous file.

Note:

If the previous or next file is not compatible, it will be skipped automatically.

- 3 Press **OK** to return to Single View mode.

To set the Slide Show mode settings:

- 1 Press **QUICK** during Slide Show mode.
- 2 Press **▽** or **△** to highlight the item (Sleep Timer, Interval Time, or Repeat).
- 3 Press **◀** or **▶** to adjust the setting.
- 4 Press **QUICK** or **RETURN** to return to Slide Show mode.

Item	Description
Sleep Timer	To set a Sleep Timer (see page 19).
Interval Time	To set a time interval to view photos (3sec, 5sec, 10sec, 15sec, 30sec, 60sec, or 90sec).
Repeat	To display photos in the same directory repeatedly. On/Off

To rotate the image:

While viewing the image in Single View mode, press **▶** to rotate the image 90 degrees clockwise, press **◀** to rotate the image 90 degrees counterclockwise.

To return to the list window:

Press **RETURN** during Single View mode or Slide Show mode.

To display file status information:

- 1** Press **[+]**. The following information will be displayed at the bottom of the screen.
 - File number/Total number of files (only for files stored in the same directory)
 - Photo title
 - Date and time taken
 - File size
 - Slide Show icon (if applicable)
 - Repeat play icon (if applicable)
 - Operation guide
- 2** Press **[+]** again to remove the information from the screen.

Note:

The file status information will disappear after about 6 seconds.

File Compatibility:

Data compatibility: JPEG Exif ver 2.2

File format: DCF ver 1.1

Maximum viewable resolution: 4096 × 4096 pixels

(Total number of pixels: 16,000,000)

Total number of files: Less than 2000 per folder

To close the Media Player:

Press **EXIT**. The TV will return to the last-viewed channel or video input.

Troubleshooting

Before calling a service technician, please check the following table for a possible cause of the symptom and some solutions.

Symptom and solution

TV will not turn on

- Make sure the power cord is plugged in, and then press $\odot/1$ or \odot .
- The remote control batteries may be dead. Replace the batteries.

No picture, no sound

- Check the aerial connections.

No sound, picture OK

- The sound may be muted. Press $\triangle +$, $-$ or M .
- The station may have broadcast difficulties. Try another channel.

Poor sound, picture OK

- The station may have broadcast difficulties. Try another channel.

Poor picture, sound OK

- Check the aerial connections.
- The station may have broadcast difficulties. Try another channel.
- Adjust the **PICTURE** menu.

Poor reception of broadcast channels

- Check the aerial connections.
- The station may have broadcast difficulties. Try another channel.
- Make sure the **Colour System** is properly set.

Teletext problems

- Check the aerial connections.
Good performance of text depends on a good strong broadcast signal.

The brightness of the screen comes down, or flickers of the screen are caused, or some parts of the screen do not light up.

- When you just buy and start to use this TV, a flickering may be caused in the screen. In this case, switch off the TV, then switch on it again to cure the condition.
- The cold cathode fluorescent lamp used for the back light on this TV has longevity. When the brightness of the screen comes down, or the flickers of the screen are caused, or some parts of the screen do not light up, it may reach the end of its life. Contact a service technician.

Some pixels of the screen do not light up

- The LCD display panel is manufactured using an extremely high level of precision technology, however, sometimes some pixels of the screen may be missing picture elements or have luminous spots. This is not a sign of a malfunction.

The picture brightness varies when you display switch the TV on.

- If you switch the TV on at 0°C and under, wait until the warms up.

Multiple images

- The station may have broadcast difficulties. Try another channel.
- Aerial reception may be poor. Use a high directional outdoor aerial.
- Check if the direction of the aerial has changed.

Poor colour or no colour

- The station may have broadcast difficulties. Try another channel.
- Adjust the **Tint** and/or **Colour** in the **PICTURE** menu.

The remote control does not operate

- Make sure the remote control is set to the correct device mode.
- Remove all obstructions between the remote control and the remote control sensor on the TV.
- The remote control batteries may be dead. Replace the batteries.

Broadcast system

Broadcast transmission systems of each country or region

Asia M.E.

Country or region	Colour	Sound
Bahrain, Kuwait, Israel, Oman, Qatar, United Arab Emirates, Yemen, etc. Indonesia, Malaysia, Singapore, Thailand, etc.	PAL	B/G
China, Vietnam	PAL	D/K
China Hong Kong	PAL	I

Country or region	Colour	Sound
Iraq, Islamic Republic of Iran, Lebanon, Saudi Arabia, etc.	SECAM	B/G
Russian Federation, etc.	SECAM	D/K
Myanmar, Republic of the Philippines, etc.	NTSC	M

Oceania

Country or region	Colour	Sound
Australia, New Zealand, etc.	PAL	B/G

Africa

Country or region	Colour	Sound
Republic of South Africa, etc.	PAL	I

South America

Country or region	Colour	Sound
Brazil	PAL	M
Chile, Colombia, etc.	NTSC	M

Note:

PAL, SECAM and NTSC 3.58 (MHz) are different colour signal broadcast transmission systems applicable to different countries or region. NTSC 4.43 (MHz) is used in special VCRs to playback NTSC recorded video tapes through PAL TV equipment.

Specifications**LCD colour TV****Model**

32AV700E, 32AV700T, 32AV700V,
40AV700E, 40AV700T, 40AV700V

Power source

110V-240V AC, 50/60Hz

Power consumption

32" : 90 W, 0.5 W (standby)
40" : 160 W, 0.5W (standby)

Dimensions

32" : 786 mm (W) 568 mm (H) 221 mm (D)
40" : 976 mm (W) 666 mm (H) 241mm (D)

Mass (Weight)

32" : 10.0 kg

40" : 14.0 kg

TV system (Aerial input)

Channel coverage:

PAL	B/G (CCIR)	VHF	2 - 12
		UHF	21 - 69
		CATV	X - Z+2, S1 - S41
PAL	I (UK)	VHF	-
		UHF	21 - 69
		CATV	-
PAL	D/K (CHINA)	VHF	1 - 12
		UHF	13 - 57
		CATV	Z1 - Z38
SECAM	B/G (CCIR)	VHF	2 - 12
		UHF	21 - 69
		CATV	X - Z+2, S1 - S41
SECAM	D/K (OIRT)	VHF	1 - 12
		UHF	21 - 69
		CATV	X1 - X19
NTSC	M (US)	VHF	2 - 13
		UHF	14 - 69
		CATV	A6 - A1, A - W, AA - ZZ, AAA, BBB
NTSC	M (JAPAN)	VHF	1 - 12
		UHF	13 - 62
		CATV	M1 - M10, S1 - S41

Special RF signal:

NTSC 4.43 colour system

5.5/6.0/6.5 MHz sound system

PAL 60 Hz colour system

5.5/6.0/6.5 MHz sound system

COMPONENT VIDEO INPUT terminals (the signal format)

480i, 480p, 576i, 576p, 720p (50/60 Hz),
1080i (50/60 Hz)

(These signal formats are converted to match the number of pixels of the LCD panel.)

Colour System

PAL, SECAM, NTSC 3.58/4.43

Aspect ratio

16 : 9

Visible size (diagonal)

32" : 80 cm

40" : 101.6 cm

Number of pixels

32" : 1366 (H) dots × 768 (V) dots

40" : 1920 (H) dots × 1080 (V) dots

Audio power

32" : 5 W + 5 W

40" : 10 W + 10 W

Speakers

Main 42 × 160 mm 2pcs.

Reference section

Input/Output terminals

⊖ (1)	Input	
	Phono jacks	A/V
⊖ (2)	Input	
	Component video	Y, Pb/Cb, Pr/Cr
	Phono jacks	Audio L/Mono +R
⊕ AUDIO (FIXED)	Output	
	Phono jacks	Audio L/Mono +R
⊖ RGB/PC	Input	
	Mini D-sub 15 pin	Analogue RGB
⊖ PC/HDMI1 (AUDIO)	Input	
	3.5 mm (Diameter) stereo	
⊖ HDMI1 – 4	Input (type A)	
	19 pin	A/V Digital
	V.1.3a with Lip Sync	
USB port	Data compatibility:	JPEG Exif ver 2.2
	File format:	DCF ver 1.1
	Support file system:	FAT12, FA16, FAT32

Operating condition

Temperature	0°C - 35°C
Humidity	20% - 80% (No moisture condensation)

Supplied accessories

Owner's manual (1), Power cord (1),
Remote control (1), Batteries (2)

- Design and specifications are subject to change without notice.
- Never service or remodel the TV by yourself. It may expose you to a fire hazard or dangerous voltages.