



32CTQ030SPbF 32CTQ030-1PbF

SCHOTTKY RECTIFIER

32 Amp

$I_{F(AV)} = 30\text{Amp}$
 $V_R = 30\text{V}$

Major Ratings and Characteristics



Characteristics	Values	Units
$I_{F(AV)}$ Rectangular waveform	30	A
V_{RRM}	30	V
I_{FSM} @tp = 5 μ s sine	900	A
V_F @15 Apk, $T_J = 125^\circ\text{C}$	0.40	V
T_J range	-55 to 150	$^\circ\text{C}$

Description/ Features

The 32CTQ030.. Schottky rectifier series has been optimized for low reverse leakage at high temperature. The proprietary barrier technology allows for reliable operation up to 150 $^\circ\text{C}$ junction temperature. Typical applications are in switching power supplies, converters, free-wheeling diodes, and reverse battery protection.

- 150 $^\circ\text{C}$ T_J operation
- High purity, high temperature epoxy encapsulation for enhanced mechanical strength and moisture resistance
- Low forward voltage drop
- High frequency operation
- Guard ring for enhanced ruggedness and long term reliability
- Lead-Free ("PbF" suffix)

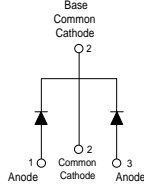
Case Styles

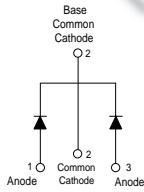
<p>32CTQ030SPbF</p>   <p>D²PAK</p>	<p>32CTQ030-1PbF</p>   <p>TO-262</p>
---	--

Voltage Ratings

Part number	32CTQ030SPbF, 32CTQ030-1PbF
V_R Max. DC Reverse Voltage (V)	30
V_{RWM} Max. Working Peak Reverse Voltage (V)	

Absolute Maximum Ratings

Parameters	32CTQ	Units	Conditions
$I_{F(AV)}$ Max. Average Forward Current * See Fig. 5	30	A	50% duty cycle @ $T_C = 115^\circ\text{C}$, rectangular wave form
I_{FSM} Max. Peak One Cycle Non-Repetitive Surge Current * See Fig. 7	900	A	5 μs Sine or 3 μs Rect. pulse
	250		10ms Sine or 6ms Rect. pulse
E_{AS} Non-Repetitive Avalanche Energy	13	mJ	$T_J = 25^\circ\text{C}$, $I_{AS} = 1.20$ Amps, $L = 11.10$ mH
I_{AR} Repetitive Avalanche Current	3	A	Current decaying linearly to zero in 1 μsec Frequency limited by T_J max. $V_A = 1.5 \times V_R$ typical

Electrical Specifications

Parameters	32CTQ	Units	Conditions
V_{FM} Max. Forward Voltage Drop (1) * See Fig. 1	0.49	V	@ 15A
	0.58	V	@ 30A
	0.40	V	@ 15A
	0.53	V	@ 30A
I_{RM} Max. Reverse Leakage Current (1) * See Fig. 2	1.75	mA	$T_J = 25^\circ\text{C}$
	97	mA	$T_J = 125^\circ\text{C}$
$V_{F(TO)}$ Threshold Voltage	0.233	V	$T_J = T_J$ max.
r_f Forward Slope Resistance	9.09	m Ω	
C_T Max. Junction Capacitance Per Leg	1300	pF	$V_R = 5V_{DC}$ (test signal range 100Khz to 1Mhz) 25°C
L_S Typical Series Inductance Per Leg	8.0	nH	Measured lead to lead 5mm from package body
dv/dt Max. Voltage Rate of Change	10000	V/ μs	(Rated V_R)

(1) Pulse Width < 300 μs , Duty Cycle < 2%

Thermal-Mechanical Specifications

Parameters	32CTQ	Units	Conditions
T_J Max. Junction Temperature Range	-55 to 150	$^\circ\text{C}$	
T_{stg} Max. Storage Temperature Range	-55 to 150	$^\circ\text{C}$	
R_{thJC} Max. Thermal Resistance Junction to Case Per Leg	3.25	$^\circ\text{C}/\text{W}$	DC operation * See Fig. 4
R_{thCS} Typical Thermal Resistance, Case to Heatsink	0.50	$^\circ\text{C}/\text{W}$	Mounting surface, smooth and greased
wt Approximate Weight	2 (0.07)	g (oz.)	
T Mounting Torque	Min. 6 (5)	Kg-cm (lbf-in)	
	Max. 12 (10)		
Marking Device	32CTQ030S	Case style D ² Pak	
	32CTQ030-1	Case style TO-262	

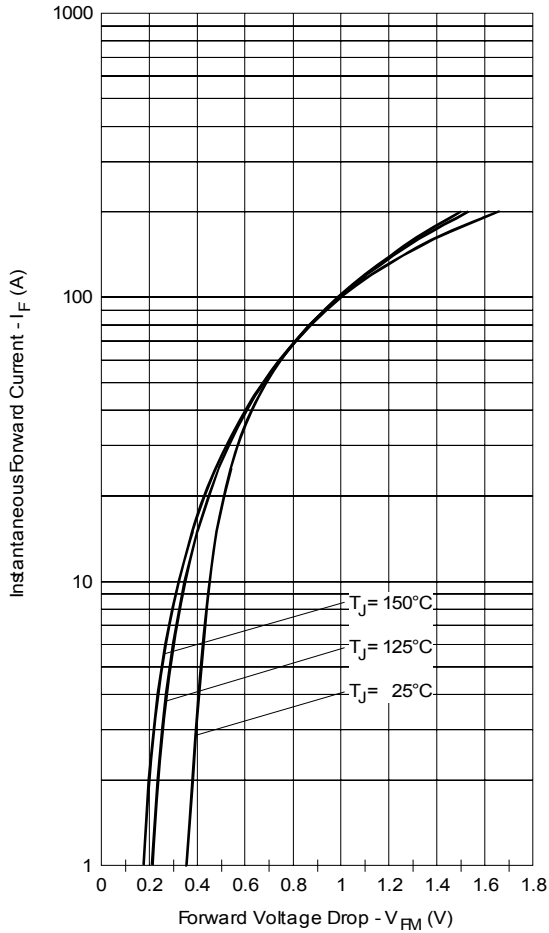

Fig. 1 - Maximum Forward Voltage Drop Characteristics

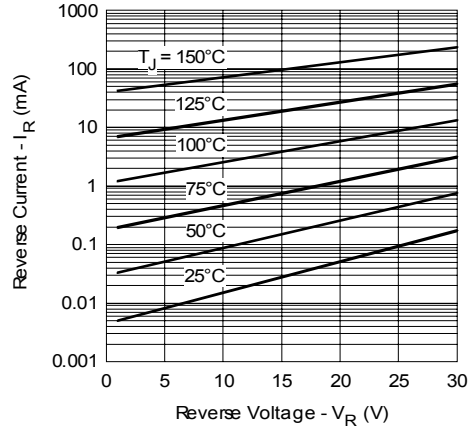

Fig. 2 - Typical Values of Reverse Current Vs. Reverse Voltage

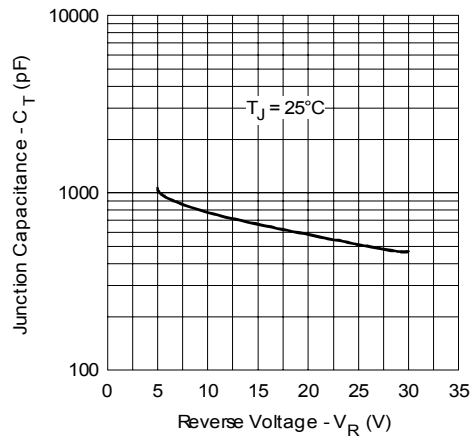

Fig. 3 - Typical Junction Capacitance Vs. Reverse Voltage

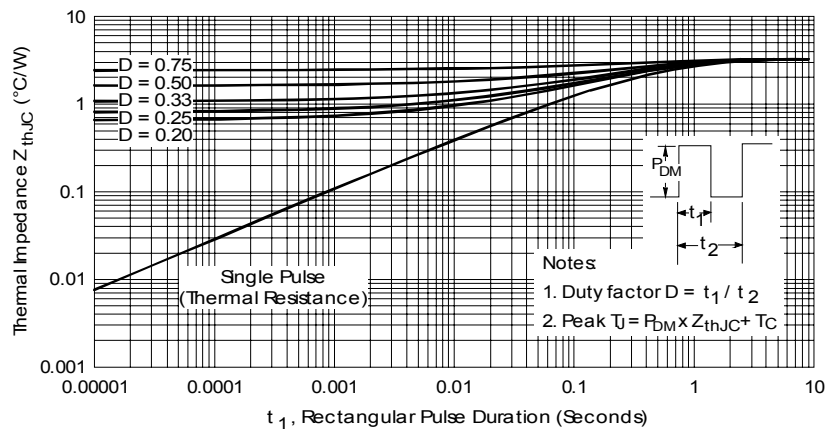

Fig. 4 - Maximum Thermal Impedance Z_{thJC} Characteristics

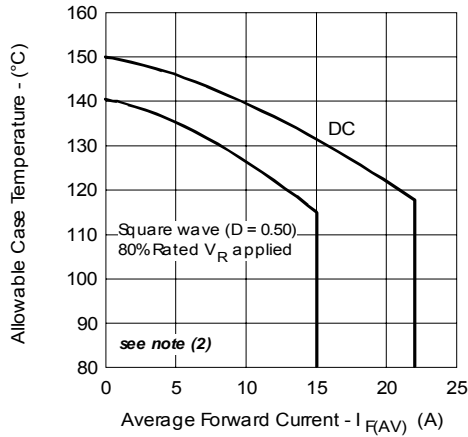

Fig. 5- Maximum Allowable Case Temperature Vs. Average Forward Current

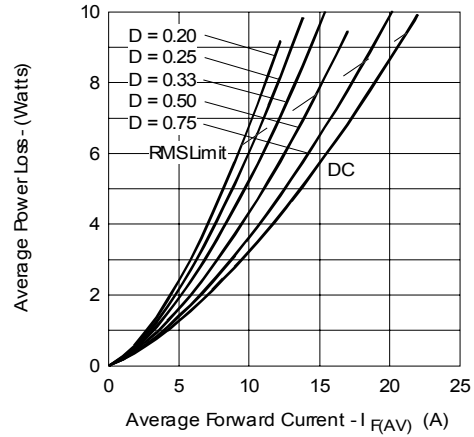

Fig. 6- Forward Power Loss Characteristics

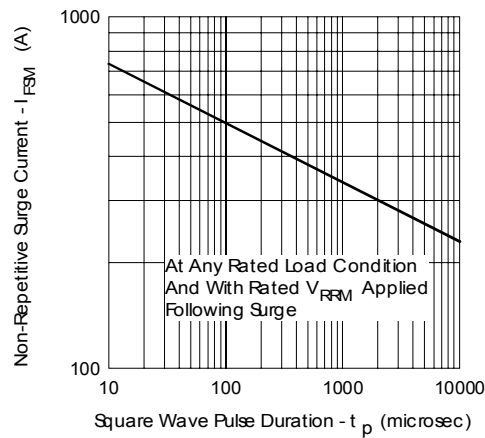

Fig. 7- Maximum Non-Repetitive Surge Current

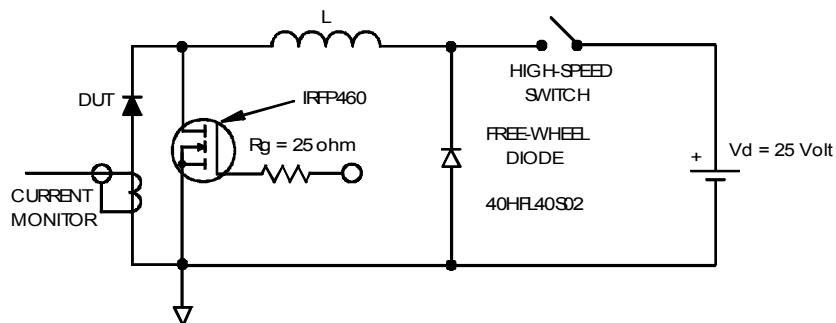
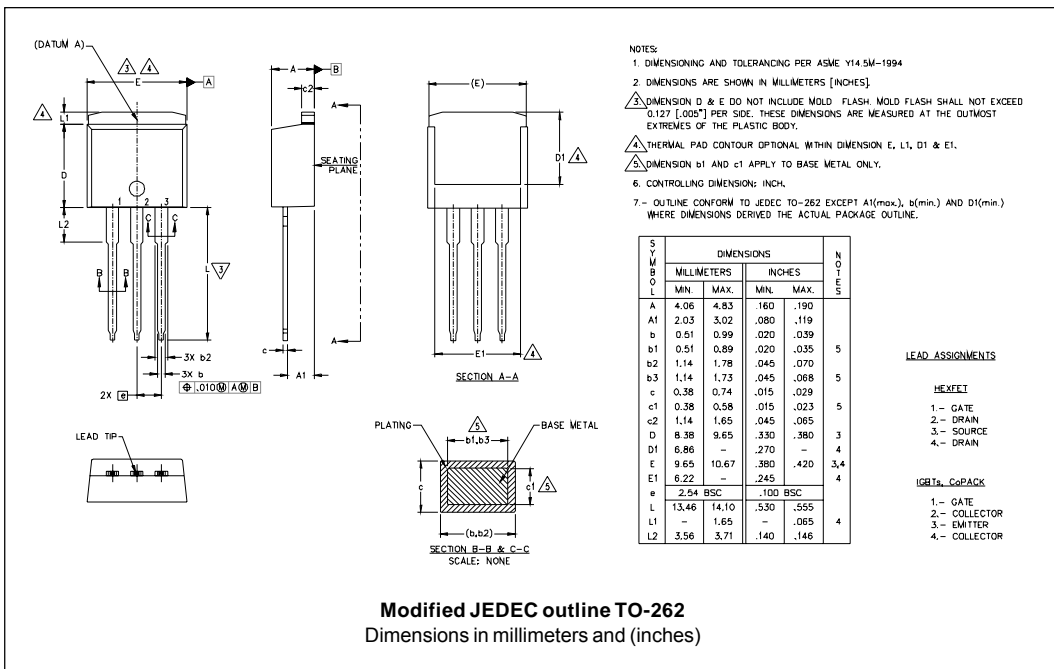
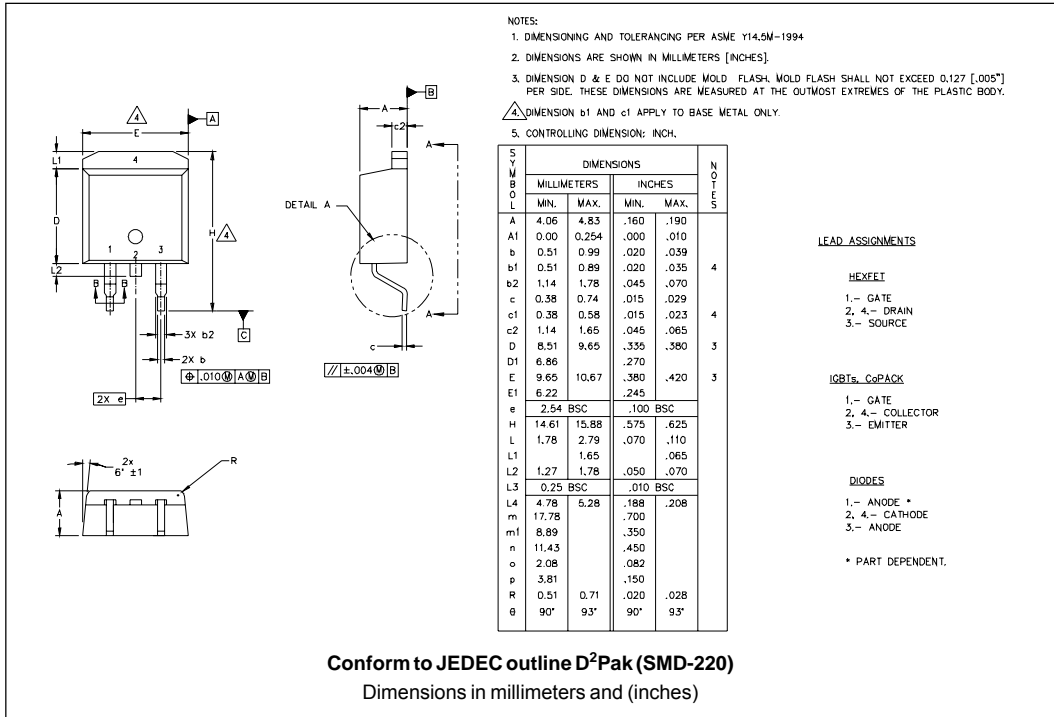

Fig. 8- Unclamped Inductive Test Circuit

- (2) Formula used: $T_C = T_J - (Pd + Pd_{REV}) \times R_{thJC}$;
 $Pd = \text{Forward Power Loss} = I_{F(AV)} \times V_{FM} @ (I_{F(AV)} / D)$ (see Fig. 6);
 $Pd_{REV} = \text{Inverse Power Loss} = V_{R1} \times I_R (1 - D)$; $I_R @ V_{R1} = 80\% \text{ rated } V_R$

Outlines Table



Part Marking Information

D²PAK

EXAMPLE: THIS IS A 32CTQ030S
LOT CODE 8024
ASSEMBLED ON WW 02, 2000

Note: "P" in assembly line position indicates "Lead-Free"

TO-262

EXAMPLE: THIS IS A 32CTQ030-1
LOT CODE 1789
ASSEMBLED ON WW 19, 2002

Note: "P" in assembly line position indicates "Lead-Free"

Tape & Reel Information

SECTION Y-Y

A ₀	10.50	+/-	0.1
B ₀	15.80	+/-	0.1
B ₂	10.25	+/-	0.1
K ₀	4.90	+/-	0.1
F	11.50	+/-	0.1
P ₁	16.00	+/-	0.1
W	24.00	+/-	0.3

NOTES:

- 1.0 10 SPROCKET HOLE PITH CUMULATIVE TOLERANCE ±.02
- 2.0 CAMBER NOT TO EXCEED 1mm in 100mm
- 3.0 MATERIAL: CONDUCTIVE BLACK STYRENIC ALLOY
- 4.0 K₀ MEASURED FROM A PLANE ON THE INSIDE BOTTOM OF THE POCKET TO THE TOP SURFACE OF THE CARRIER
- 5.0 MEASURED FROM CENTRELINE OF SPROCKET HOLE TO CENTRELINE OF POCKET
- 6.0 VENDOR: (OPTIONAL)
- 7.0 MUST ALSO MEET REQUIREMENTS OF EIA STANDAR #EIA-481A TAPING OF SURFACE MOUNT COMPONENTS FOR AUTOMATIC PLACEMENT
- 8.0 SURFACE RESISTIVITY OF MOLDED MATL. MUST MEASURE LESS OR EQUAL TO 10⁶ OHMS PER SQUARE, MEASURED IN ACCORDANCE TO PROCEDURE GIVEN IN ASTM D-257 & ASTM D-991
- 9.0 TOTAL LENGTH PER REEL MUST BE 45 METERS
- 10.0 Ⓞ CRITICAL

Dimensions in millimeters and (inches)

Ordering Information Table

Device Code																	
	<table border="1" style="margin: auto;"> <tr> <td style="padding: 5px;">32</td> <td style="padding: 5px;">C</td> <td style="padding: 5px;">T</td> <td style="padding: 5px;">Q</td> <td style="padding: 5px;">030</td> <td style="padding: 5px;">S</td> <td style="padding: 5px;">TRL</td> <td style="padding: 5px;">PbF</td> </tr> <tr> <td style="text-align: center;">①</td> <td style="text-align: center;">②</td> <td style="text-align: center;">③</td> <td style="text-align: center;">④</td> <td style="text-align: center;">⑤</td> <td style="text-align: center;">⑥</td> <td style="text-align: center;">⑦</td> <td style="text-align: center;">⑧</td> </tr> </table>	32	C	T	Q	030	S	TRL	PbF	①	②	③	④	⑤	⑥	⑦	⑧
32	C	T	Q	030	S	TRL	PbF										
①	②	③	④	⑤	⑥	⑦	⑧										
1	- Current Rating (30A)																
2	- Circuit Configuration C = Common Cathode																
3	- T = TO-220																
4	- Schottky "Q" Series																
5	- Voltage Rating (030 = 30V)																
6	- <ul style="list-style-type: none"> • S = D²Pak • -1= TO-262 																
7	- <ul style="list-style-type: none"> • none = Tube (50 pieces) • TRL = Tape & Reel (Left Oriented - for D²Pak only) • TRR = Tape & Reel (Right Oriented - for D²Pak only) 																
8	- <ul style="list-style-type: none"> • none = Standard Production • PbF = Lead-Free 																

Data and specifications subject to change without notice.
 This product has been designed and qualified for Industrial Level and Lead-Free.
 Qualification Standards can be found on IR's Web site.