

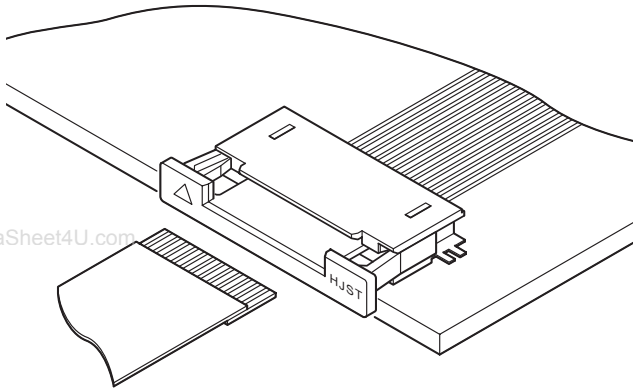

FLZ CONNECTOR

0.5mm pitch/Connectors for FFC and FPC



This extremely small 0.5mm pitch connector with a height of only 2.0mm above the PCB surface allows interconnection in extremely small spaces and is an example of JST's leading edge technology.

- Zero insertion force mechanism
- Heat resisting design suitable for surface mounting
- In-line surface mount tails
- Two types of connections
- Embossed tape for automatic mounting

Specifications

- Current rating: 0.5A AC, DC
- Voltage rating: 50V AC, DC
- Temperature range: -25°C to +85°C
(including temperature rise in applying electrical current)
- Contact resistance: Initial value/40m Ω max.
After environmental testing/60m Ω max.
- Insulation resistance: 800M Ω min.
- Withstanding voltage: 200V AC/minute
- Applicable FFC and FPC: Conductor pitch/0.5mm
Conductor width/0.35mm
Mating part thickness/0.30±0.03mm

Note: FFC and FPC to be actually used should be checked for applicability.

- * RoHS compliant products are published.
- * Refer to "General Instruction and Notice when using Terminals and Connectors" at the end of this catalog.
- * Contact JST for details.

Standards

Ⓜ Recognized E60389

Ⓢ Certified LR20812

PC board layout (viewed from component side) and Assembly layout

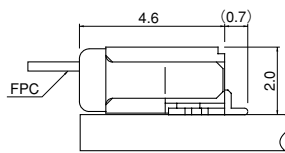
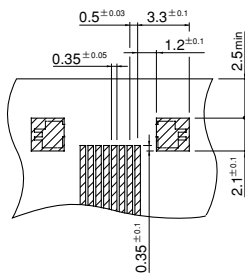

Inner lock type

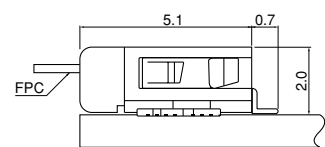
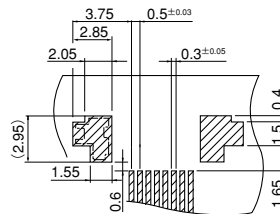

Note: 1. Tolerances are non-cumulative: ±0.03mm for all centers.
2. The dimensions above should serve as a guideline. Contact JST for details.

FLZ CONNECTOR

Connector

Normal type

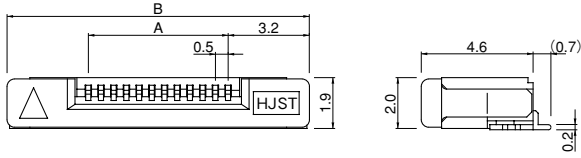

Reverse type

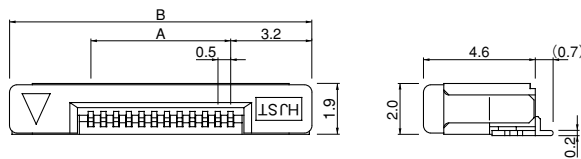

<Inner lock type>

Normal type

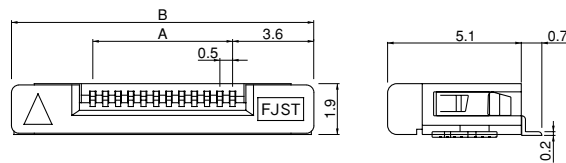

Reverse type

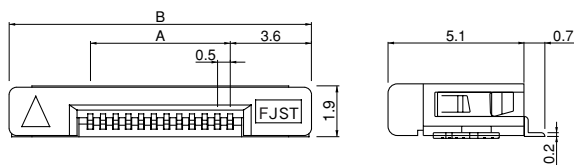

Circuits	Model No.		Dimensions (mm)		Q'ty / reel
	Normal type	Reverse type	A	B	
6	06FLZ-SM2-TB	06FLZ-RSM2-TB	2.5	8.9	2,000
7	07FLZ-SM2-TB	07FLZ-RSM2-TB	3.0	9.4	2,000
8	08FLZ-SM2-TB	08FLZ-RSM2-TB	3.5	9.9	2,000
9	09FLZ-SM2-TB	09FLZ-RSM2-TB	4.0	10.4	2,000
10	10FLZ-SM2-TB	10FLZ-RSM2-TB	4.5	10.9	2,000
11	11FLZ-SM2-TB	11FLZ-RSM2-TB	5.0	11.4	2,000
12	12FLZ-SM2-TB	12FLZ-RSM2-TB	5.5	11.9	2,000
13	13FLZ-SM2-TB	13FLZ-RSM2-TB	6.0	12.4	2,000
14	14FLZ-SM2-TB	14FLZ-RSM2-TB	6.5	12.9	2,000
15	15FLZ-SM2-TB	15FLZ-RSM2-TB	7.0	13.4	2,000
16	16FLZ-SM2-TB	16FLZ-RSM2-TB	7.5	13.9	2,000
17	17FLZ-SM2-TB	17FLZ-RSM2-TB	8.0	14.4	2,000
18	18FLZ-SM2-TB	18FLZ-RSM2-TB	8.5	14.9	2,000
19	19FLZ-SM2-TB	19FLZ-RSM2-TB	9.0	15.4	2,000
20	20FLZ-SM2-TB	20FLZ-RSM2-TB	9.5	15.9	2,000
21	21FLZ-SM2-TB	21FLZ-RSM2-TB	10.0	16.4	2,000
22	22FLZ-SM2-TB	22FLZ-RSM2-TB	10.5	16.9	2,000
23	23FLZ-SM2-TB	23FLZ-RSM2-TB	11.0	17.4	2,000
24	24FLZ-SM2-TB	24FLZ-RSM2-TB	11.5	17.9	2,000
25	25FLZ-SM2-TB	25FLZ-RSM2-TB	12.0	18.4	2,000
26	26FLZ-SM2-TB	26FLZ-RSM2-TB	12.5	18.9	2,000
27	27FLZ-SM2-TB	27FLZ-RSM2-TB	13.0	19.4	2,000
28	28FLZ-SM2-TB	28FLZ-RSM2-TB	13.5	19.9	2,000
30	30FLZ-SM2-TB	30FLZ-RSM2-TB	14.5	20.9	2,000
33	33FLZ-SM2-TB	—	16.0	22.4	2,000

<Inner lock type>

Circuits	Model No.		Dimensions (mm)		Q'ty / reel
	Normal type	Reverse type	A	B	
13	—	13FLZ-RSM2-R-TB	6.0	13.1	2,000
30	30FLZ-SM2-R-TB	—	14.5	21.6	2,000
32	32FLZ-SM2-R-TB	32FLZ-RSM2-R-TB	15.5	22.6	2,000
34	34FLZ-SM2-R-TB	34FLZ-RSM2-R-TB	16.5	23.6	2,000
36	36FLZ-SM2-R-TB	36FLZ-RSM2-R-TB	17.5	24.6	2,000
40	40FLZ-SM2-R-TB	40FLZ-RSM2-R-TB	19.5	26.6	2,000
42	42FLZ-SM2-R-TB	—	20.5	27.6	2,000
45	45FLZ-SM2-R-TB	—	22.0	29.1	2,000
50	50FLZ-SM2-R-TB	—	24.5	31.6	2,000

Material and Finish

Contact: Phosphor bronze, copper-undercoated, tin-plated (reflow treatment)
 Slider housing: PA 6T, UL94V-0 (black)
 Housing: PA 6T, UL94V-0
 Normal type...gray
 Reverse type...natural
 Solder tab: Phosphor bronze, copper-undercoated, tin-plated (reflow treatment)

RoHS compliance This product displays (LF)(SN) on a label.
 Note: The products listed above are supplied on embossed tape.

Lead section dimensions of FFC and FPC

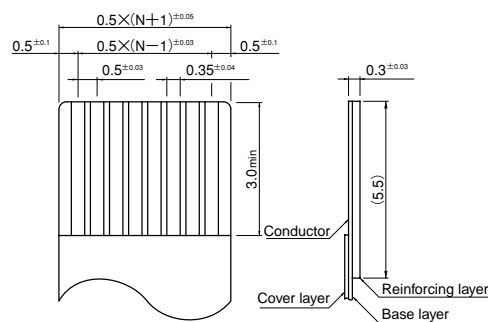

Note: N --- Number of circuits

FLZ CONNECTOR

Taping specifications

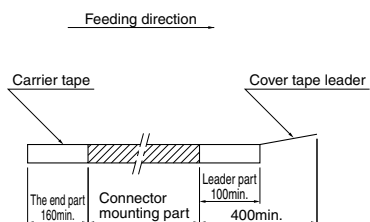
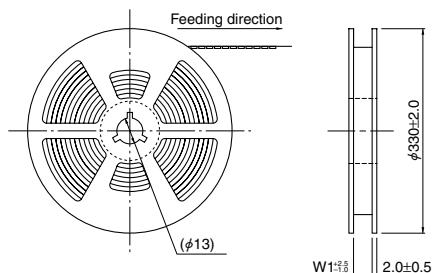

(6 to 24 circuits)

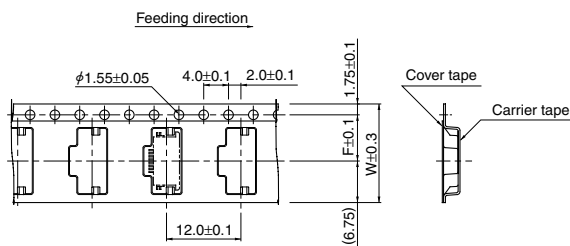

(25 to 50 circuits)

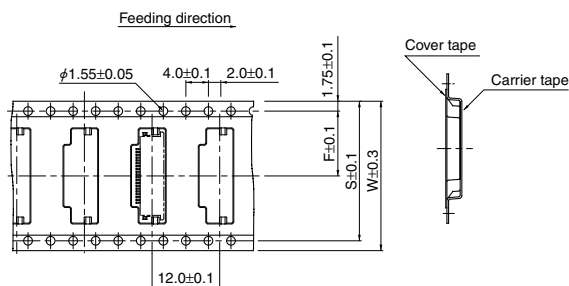

Circuits	Taping dimensions (mm)			Reel dimensions (mm)	Q'ty / reel
	F	S	W	W1	
6 to 8	7.5	-	16.0	17.5	2,000
9 to 24	11.5	-	24.0	25.5	2,000
25 to 30	14.2	28.4	32.0	33.5	2,000
32 to 50	20.2	40.4	44.0	45.5	2,000

Note:

- Specifications conform to JIS C 0806. The tape width, connector recess dimensions, etc. are determined by the number of circuits and external shape of the connector to be loaded.
- Specifications are subject to change without prior notice.