



North/Latin America
Europe/Africa
Asia/Oceania

Internal Use Only

<http://aic.lgservice.com>
<http://eic.lgservice.com>
<http://biz.lgservice.com>

LCD TV

SERVICE MANUAL

CHASSIS : LP91D

MODEL : 32LH70YR 32LH70YR-LA/TA

CAUTION

BEFORE SERVICING THE CHASSIS,
READ THE SAFETY PRECAUTIONS IN THIS MANUAL.



CONTENTS

CONTENTS	2
PRODUCT SAFETY	3
SPECIFICATION	6
ADJUSTMENT INSTRUCTION	9
TROUBLE SHOOTING.....	14
BLOCK DIAGRAM.....	17
EXPLODED VIEW	18
SVC. SHEET	

SAFETY PRECAUTIONS

IMPORTANT SAFETY NOTICE

Many electrical and mechanical parts in this chassis have special safety-related characteristics. These parts are identified by \triangle in the Schematic Diagram and Exploded View.

It is essential that these special safety parts should be replaced with the same components as recommended in this manual to prevent Shock, Fire, or other Hazards.

Do not modify the original design without permission of manufacturer.

General Guidance

An **isolation Transformer should always be used** during the servicing of a receiver whose chassis is not isolated from the AC power line. Use a transformer of adequate power rating as this protects the technician from accidents resulting in personal injury from electrical shocks.

It will also protect the receiver and its components from being damaged by accidental shorts of the circuitry that may be inadvertently introduced during the service operation.

If any fuse (or Fusible Resistor) in this TV receiver is blown, replace it with the specified.

When replacing a high wattage resistor (Oxide Metal Film Resistor, over 1W), keep the resistor 10mm away from PCB.

Keep wires away from high voltage or high temperature parts.

Before returning the receiver to the customer,

always perform an **AC leakage current check** on the exposed metallic parts of the cabinet, such as antennas, terminals, etc., to be sure the set is safe to operate without damage of electrical shock.

Leakage Current Cold Check(Antenna Cold Check)

With the instrument AC plug removed from AC source, connect an electrical jumper across the two AC plug prongs. Place the AC switch in the on position, connect one lead of ohm-meter to the AC plug prongs tied together and touch other ohm-meter lead in turn to each exposed metallic parts such as antenna terminals, phone jacks, etc.

If the exposed metallic part has a return path to the chassis, the measured resistance should be between $1M\Omega$ and $5.2M\Omega$.

When the exposed metal has no return path to the chassis the reading must be infinite.

An other abnormality exists that must be corrected before the receiver is returned to the customer.

Leakage Current Hot Check (See below Figure)

Plug the AC cord directly into the AC outlet.

Do not use a line Isolation Transformer during this check.

Connect 1.5K/10watt resistor in parallel with a 0.15uF capacitor between a known good earth ground (Water Pipe, Conduit, etc.) and the exposed metallic parts.

Measure the AC voltage across the resistor using AC voltmeter with 1000 ohms/volt or more sensitivity.

Reverse plug the AC cord into the AC outlet and repeat AC voltage measurements for each exposed metallic part. Any voltage measured must not exceed 0.75 volt RMS which corresponds to 0.5mA.

In case any measurement is out of the limits specified, there is possibility of shock hazard and the set must be checked and repaired before it is returned to the customer.

Leakage Current Hot Check circuit

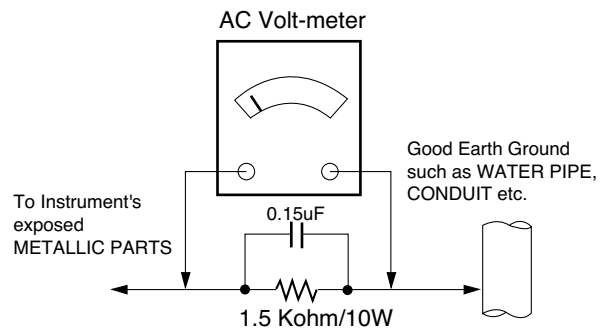

When 25A is impressed between Earth and 2nd Ground for 1 second, Resistance must be less than 0.1Ω

*Base on Adjustment standard

SERVICING PRECAUTIONS

CAUTION: Before servicing receivers covered by this service manual and its supplements and addenda, read and follow the SAFETY PRECAUTIONS on page 3 of this publication.

NOTE: If unforeseen circumstances create conflict between the following servicing precautions and any of the safety precautions on page 3 of this publication, always follow the safety precautions. Remember: Safety First.

General Servicing Precautions

1. Always unplug the receiver AC power cord from the AC power source before;
 - a. Removing or reinstalling any component, circuit board module or any other receiver assembly.
 - b. Disconnecting or reconnecting any receiver electrical plug or other electrical connection.
 - c. Connecting a test substitute in parallel with an electrolytic capacitor in the receiver.
CAUTION: A wrong part substitution or incorrect polarity installation of electrolytic capacitors may result in an explosion hazard.

2. Test high voltage only by measuring it with an appropriate high voltage meter or other voltage measuring device (DVM, FETVOM, etc) equipped with a suitable high voltage probe. Do not test high voltage by "drawing an arc".

3. Do not spray chemicals on or near this receiver or any of its assemblies.

4. Unless specified otherwise in this service manual, clean electrical contacts only by applying the following mixture to the contacts with a pipe cleaner, cotton-tipped stick or comparable non-abrasive applicator; 10% (by volume) Acetone and 90% (by volume) isopropyl alcohol (90%-99% strength)

CAUTION: This is a flammable mixture.

Unless specified otherwise in this service manual, lubrication of contacts is not required.

5. Do not defeat any plug/socket B+ voltage interlocks with which receivers covered by this service manual might be equipped.
6. Do not apply AC power to this instrument and/or any of its electrical assemblies unless all solid-state device heat sinks are correctly installed.
7. Always connect the test receiver ground lead to the receiver chassis ground before connecting the test receiver positive lead.
Always remove the test receiver ground lead last.
8. Use with this receiver only the test fixtures specified in this service manual.

CAUTION: Do not connect the test fixture ground strap to any heat sink in this receiver.

Electrostatically Sensitive (ES) Devices

Some semiconductor (solid-state) devices can be damaged easily by static electricity. Such components commonly are called Electrostatically Sensitive (ES) Devices. Examples of typical ES devices are integrated circuits and some field-effect transistors and semiconductor "chip" components. The following techniques should be used to help reduce the incidence of component damage caused by static by static electricity.

1. Immediately before handling any semiconductor component or semiconductor-equipped assembly, drain off any electrostatic charge on your body by touching a known earth ground. Alternatively, obtain and wear a commercially available discharging wrist strap device, which should be removed to prevent potential shock reasons prior to applying power to the

unit under test.

2. After removing an electrical assembly equipped with ES devices, place the assembly on a conductive surface such as aluminum foil, to prevent electrostatic charge buildup or exposure of the assembly.
3. Use only a grounded-tip soldering iron to solder or unsolder ES devices.
4. Use only an anti-static type solder removal device. Some solder removal devices not classified as "anti-static" can generate electrical charges sufficient to damage ES devices.
5. Do not use freon-propelled chemicals. These can generate electrical charges sufficient to damage ES devices.
6. Do not remove a replacement ES device from its protective package until immediately before you are ready to install it. (Most replacement ES devices are packaged with leads electrically shorted together by conductive foam, aluminum foil or comparable conductive material).
7. Immediately before removing the protective material from the leads of a replacement ES device, touch the protective material to the chassis or circuit assembly into which the device will be installed.
CAUTION: Be sure no power is applied to the chassis or circuit, and observe all other safety precautions.
8. Minimize bodily motions when handling unpackaged replacement ES devices. (Otherwise harmless motion such as the brushing together of your clothes fabric or the lifting of your foot from a carpeted floor can generate static electricity sufficient to damage an ES device.)

General Soldering Guidelines

1. Use a grounded-tip, low-wattage soldering iron and appropriate tip size and shape that will maintain tip temperature within the range or 500°F to 600°F.
2. Use an appropriate gauge of RMA resin-core solder composed of 60 parts tin/40 parts lead.
3. Keep the soldering iron tip clean and well tinned.
4. Thoroughly clean the surfaces to be soldered. Use a mall wire-bristle (0.5 inch, or 1.25cm) brush with a metal handle. Do not use freon-propelled spray-on cleaners.
5. Use the following unsoldering technique
 - a. Allow the soldering iron tip to reach normal temperature. (500°F to 600°F)
 - b. Heat the component lead until the solder melts.
 - c. Quickly draw the melted solder with an anti-static, suction-type solder removal device or with solder braid.
CAUTION: Work quickly to avoid overheating the circuit board printed foil.
6. Use the following soldering technique.
 - a. Allow the soldering iron tip to reach a normal temperature (500°F to 600°F)
 - b. First, hold the soldering iron tip and solder the strand against the component lead until the solder melts.
 - c. Quickly move the soldering iron tip to the junction of the component lead and the printed circuit foil, and hold it there only until the solder flows onto and around both the component lead and the foil.
CAUTION: Work quickly to avoid overheating the circuit board printed foil.
 - d. Closely inspect the solder area and remove any excess or splashed solder with a small wire-bristle brush.

IC Remove/Replacement

Some chassis circuit boards have slotted holes (oblong) through which the IC leads are inserted and then bent flat against the circuit foil. When holes are the slotted type, the following technique should be used to remove and replace the IC. When working with boards using the familiar round hole, use the standard technique as outlined in paragraphs 5 and 6 above.

Removal

1. Desolder and straighten each IC lead in one operation by gently prying up on the lead with the soldering iron tip as the solder melts.
2. Draw away the melted solder with an anti-static suction-type solder removal device (or with solder braid) before removing the IC.

Replacement

1. Carefully insert the replacement IC in the circuit board.
2. Carefully bend each IC lead against the circuit foil pad and solder it.
3. Clean the soldered areas with a small wire-bristle brush. (It is not necessary to reapply acrylic coating to the areas).

"Small-Signal" Discrete Transistor

Removal/Replacement

1. Remove the defective transistor by clipping its leads as close as possible to the component body.
2. Bend into a "U" shape the end of each of three leads remaining on the circuit board.
3. Bend into a "U" shape the replacement transistor leads.
4. Connect the replacement transistor leads to the corresponding leads extending from the circuit board and crimp the "U" with long nose pliers to insure metal to metal contact then solder each connection.

Power Output, Transistor Device

Removal/Replacement

1. Heat and remove all solder from around the transistor leads.
2. Remove the heat sink mounting screw (if so equipped).
3. Carefully remove the transistor from the heat sink of the circuit board.
4. Insert new transistor in the circuit board.
5. Solder each transistor lead, and clip off excess lead.
6. Replace heat sink.

Diode Removal/Replacement

1. Remove defective diode by clipping its leads as close as possible to diode body.
2. Bend the two remaining leads perpendicular y to the circuit board.
3. Observing diode polarity, wrap each lead of the new diode around the corresponding lead on the circuit board.
4. Securely crimp each connection and solder it.
5. Inspect (on the circuit board copper side) the solder joints of the two "original" leads. If they are not shiny, reheat them and if necessary, apply additional solder.

Fuse and Conventional Resistor

Removal/Replacement

1. Clip each fuse or resistor lead at top of the circuit board hollow stake.
2. Securely crimp the leads of replacement component around notch at stake top.
3. Solder the connections.

CAUTION: Maintain original spacing between the replaced component and adjacent components and the circuit board to prevent excessive component temperatures.

Circuit Board Foil Repair

Excessive heat applied to the copper foil of any printed circuit board will weaken the adhesive that bonds the foil to the circuit board causing the foil to separate from or "lift-off" the board. The following guidelines and procedures should be followed whenever this condition is encountered.

At IC Connections

To repair a defective copper pattern at IC connections use the following procedure to install a jumper wire on the copper pattern side of the circuit board. (Use this technique only on IC connections).

1. Carefully remove the damaged copper pattern with a sharp knife. (Remove only as much copper as absolutely necessary).
2. Carefully scratch away the solder resist and acrylic coating (if used) from the end of the remaining copper pattern.
3. Bend a small "U" in one end of a small gauge jumper wire and carefully crimp it around the IC pin. Solder the IC connection.
4. Route the jumper wire along the path of the out-away copper pattern and let it overlap the previously scraped end of the good copper pattern. Solder the overlapped area and clip off any excess jumper wire.

At Other Connections

Use the following technique to repair the defective copper pattern at connections other than IC Pins. This technique involves the installation of a jumper wire on the component side of the circuit board.

1. Remove the defective copper pattern with a sharp knife. Remove at least 1/4 inch of copper, to ensure that a hazardous condition will not exist if the jumper wire opens.
2. Trace along the copper pattern from both sides of the pattern break and locate the nearest component that is directly connected to the affected copper pattern.
3. Connect insulated 20-gauge jumper wire from the lead of the nearest component on one side of the pattern break to the lead of the nearest component on the other side. Carefully crimp and solder the connections.

CAUTION: Be sure the insulated jumper wire is dressed so the it does not touch components or sharp edges.

SPECIFICATION

NOTE : Specifications and others are subject to change without notice for improvement.

1. Application range

This spec sheet is applied to LCD TV used LP91D chassis.

2. Specification

Each part is tested as below without special appointment.

- 1) Temperature : 25±5°C (77±9°F), CST : 40±5°C
- 2) Relative Humidity : 65±10%
- 3) Power Voltage : Standard input voltage(100~240V@50/60Hz)
* Standard Voltage of each products is marked by models.
- 4) Specification and performance of each parts are followed each drawing and specification by part number in accordance with BOM.
- 5) The receiver must be operated for about 5 minutes prior to the adjustment.

3. Test method

- 1) Performance: LGE TV test method followed
- 2) Demanded other specification
 - Safety: CE, IEC specification
 - EMC : CE, IEC

4. Electrical specification

4.1. General Specification

No	Item	Specification	Measurement	Remark
1	Screen Size	32" wide Color Display Module		Resolution : 1920*1080
2	Aspect Ratio	16:9		
3	LCD Module	32" TFT WUXGA LCD		FHD
4	Operating Environment	Temp.: 0 ~ 40 deg		
		Humidity : 0 ~ 80 %		
5	Storage Environment	Temp.: -20 ~ 60 deg		
		Humidity : 0~ 85 %		
6	Input Voltage	AC100-240V~, 50/60Hz		
		≤ 180 W 32" FHD, 100Hz		
7	LDC Module (Maker : LGD)	FHD	760 x 450 x 48	
			0.36375 x 0.36375	
	Coating		3H	

5. Chroma& Brightness (Optical)

5.1. LCD Module

- the Color Coordinates check condition
- 50cm from the surface, Full White Pattern
- Picture mode Vivid

No.	Item		Min.	Typ.	Max.	Unit	Maker	Remark
1.	Luminance (W/O PC mode)		400	500		cd/m ²		
2.	View angle (R/L, U/D)			178/ 178		degree	LGD	CR > 10
3.	Color Coordinates	White	Typ -0.03	Wx	Typ +0.03			LGD 32"(FHD) LC320WUD-SBA1 (100Hz/Slim)
Wy								
RED		Xr						
		Yr						
Green		Xg						
		Yg						
Blue		Xb						
		Yb						
4.	Contrast ratio		900:1	1300:1				LGD 32"(100Hz)
5.	Luminance Variation				1.3			

6. Component Video Input (Y, Pb, Pr)

No	Specification				Remark
	Resolution	H-freq(kHz)	V-freq(Hz)	Pixel Clock(MHz)	
1	720* 480	15.73	59.94	13.500	SDTV, DVD 480I(525I)
2	720* 480	15.75	60.00	13.514	SDTV, DVD 480I(525I)
3	720* 576	15.625	50.00	13.500	SDTV, DVD 576I(625I) 50Hz
4	720* 480	31.47	59.94	27.000	SDTV 480P
5	720* 480	31.50	60.00	27.027	SDTV 480P
6	720* 576	31.25	50.00	27.000	SDTV 576P 50Hz
7	1280* 720	44.96	59.94	74.176	HDTV 720P
8	1280* 720	45.00	60.00	74.250	HDTV 720P
9	1280* 720	37.50	50.00	74.25	HDTV 720P 50Hz
10	1920* 1080	28.125	50.00	74.250	HDTV 1080I 50Hz,
11	1920* 1080	33.72	59.94	74.176	HDTV 1080I
12	1920* 1080	33.75	60.00	74.25	HDTV 1080I
13	1920* 1080	56.25	50	148.5	HDTV 1080P
14	1920* 1080	67.432	59.94	148.350	HDTV 1080P
15	1920* 1080	67.5	60.00	148.5	HDTV 1080P

7. RGB

7.1. Analog PC, RGB- DTV –NOT SUPPORT

No	Specification				Remark	
	Resolution	H-freq(kHz)	V-freq(Hz)	Pixel Clock(MHz)		
1	640* 350	31.468	70.09	25.17	EGA	
2	720* 400	31.469	70.09	28.32	DOS	
3	640* 480	31.469	59.94	25.17	VESA(VGA)	
4	800* 600	37.879	60.317	40	VESA(SVGA)	
5	1024* 768	48.363	60.004	65	VESA(XGA)	
6	1280* 768	47.776	59.87	79.5	VESA(WXGA)	
7	1360* 768	47.72	59.799	84.75	VESA(WXGA)	
8	1280* 1024	63.668	59.895	109.00	XGA	Only FHD Model
9	1920* 1080	66.587	59.934	138.50	WUXGA(Reduced Blanking)	Only FHD Model

8. HDMI Input

8.1. PC –Spec. out but it can be shown the picture at only HDMI/ DVI IN 1 via DVI to HDMI Cable)

No	Resolution	H-freq(kHz)	V-freq.(Hz)	Pixel clock(MHz)	Proposed	Remark
1	640 x 480	31.469	59.94	25.17	VESA(VGA)	
2	800 x 600	37.879	60.317	40.00	VESA(SVGA)	
3	1024 x 768	48.363	60.004	65.00	VESA(XGA)	
4	1280 x 768	47.776	59.87	79.5	VESA(WXGA)	
5	1360 x 768	47.72	59.799	84.62	VESA(WXGA)	
6	1366 x 768	47.7	60.00	84.62	WXGA	
7	1280 x 1024	63.595	60.00	108.875	SXGA	
8	1920 x 1080	66.647	59.988	138.625	WUXGA	

8.2. DTV Mode

No	Specification				Remark	
	Resolution	H-freq(kHz)	V-freq(Hz)	Pixel Clock(MHz)		
1	720 x 480	15.73	59.94	13.500	SDTV, DVD 480I(525I)	Spec. out but display.
2	720 x 480	15.75	60.00	13.514	SDTV, DVD 480I(525I)	
3	720 x 576	15.625	50.00	13.500	SDTV, DVD 576I(625I) 50Hz	
4	720 x 480	31.47	59.94	27	SDTV 480P	
5	720 x 480	31.5	60.00	27.027	SDTV 480P	
6	720 x 576	31.25	50.00	27	SDTV 576P	
7	1280 x 720	44.96	59.94	74.176	HDTV 720P	
8	1280 x 720	45	60.00	74.25	HDTV 720P	
9	1280 x 720	37.5	50.00	74.25	HDTV 720P	
10	1920 x 1080	28.125	50.00	74.25	HDTV 1080I	
11	1920 x 1080	33.72	59.94	74.176	HDTV 1080I	
12	1920 x 1080	33.75	60.00	74.25	HDTV 1080I	
13	1920 x 1080	56.25	50.00	148.5	HDTV 1080P	
14	1920 x 1080	67.432	59.94	148.350	HDTV 1080P	
15	1920 x 1080	67.5	60.00	148.5	HDTV 1080P	
16	1920 x 1080	27	24.00	74.25	HDTV 1080P	
17	1920 x 1080	33.75	30.00	74.25	HDTV 1080P	

ADJUSTMENT INSTRUCTION

1. Application Range

This specification sheet is applied to all of the LCD TV, LP91A/B/C/D chassis.

2. Specification

- 1) Because this is not a hot chassis, it is not necessary to use an isolation transformer. However, the use of isolation transformer will help protect test instrument.
- 2) Adjustment must be done in the correct order.
- 3) The adjustment must be performed in the circumstance of 25 ± 5 °C of temperature and $65 \pm 10\%$ of relative humidity if there is no specific designation.
- 4) The input voltage of the receiver must keep 100~220V, 50/60Hz.
- 5) Before adjustment, execute Heat-Run for 5 minutes at RF no signal.

3. Adjustment items

3.1. PCB assembly adjustment items

- (1) Download the MSTAR main software (IC800, Mstar ISP Utility)
 - 1) Using D/L Jig
 - 2) Using USB Memory Stick.
- (2) Input Tool-Option/Area option.
- (3) Download the EDID
 - EDID datas are automatically download when adjusting the Tool Option2
- (4) ADC Calibration – RGB / Component
- (4) Check SW Version.

3.2. SET assembly adjustment items

- (1) Input Area option
- (2) Adjustment of White Balance : Auto & Manual
- (3) Input Tool-Option/Area option
- (4) Intelligent Sensor Inspection Guide
- (5) Preset CH information
- (6) Factoring Option Data input

4. PCB assembly adjustment method

4.1. Mstar Main S/W program download

- 4.1.1. Using D/L Jig
 - (1) Preliminary steps
 - 1) Connect the download jig to D-sub(RGB) jack

- LH70

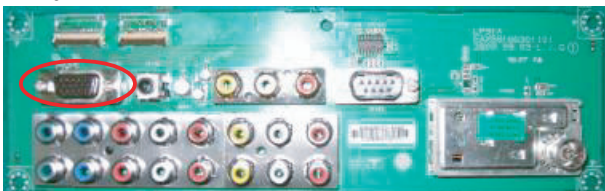

- (2) Download steps
 - 1) Execute 'ISP Tool' program, the main window(Mstar ISP utility Vx.x.x) will be opened
 - 2) Click the "Connect" button and confirm "Dialog Box"

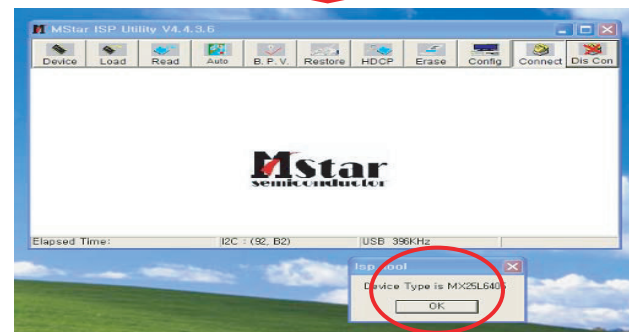
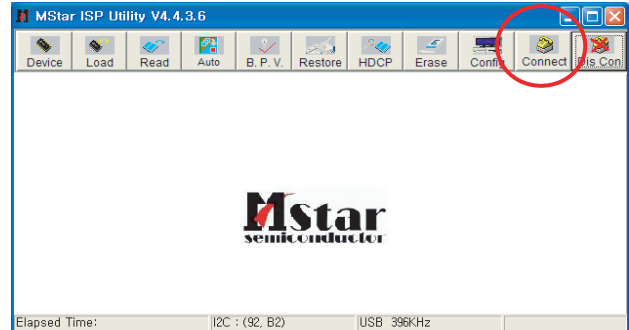

- 3) Click the "Config." button and Change speed I2C Speed setting : 350KHz~400KHz

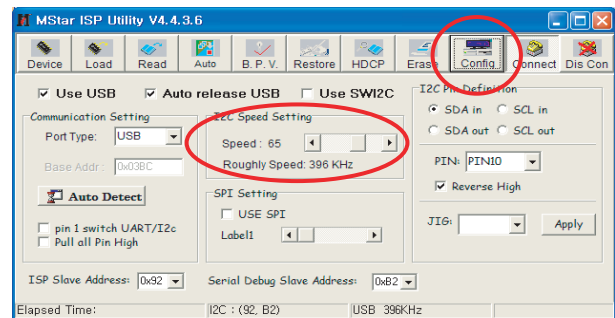

- 4) Read and write bin file.
 - Click "(1)Read" tab, and then load download file(XXXX.bin) by clicking "Read".

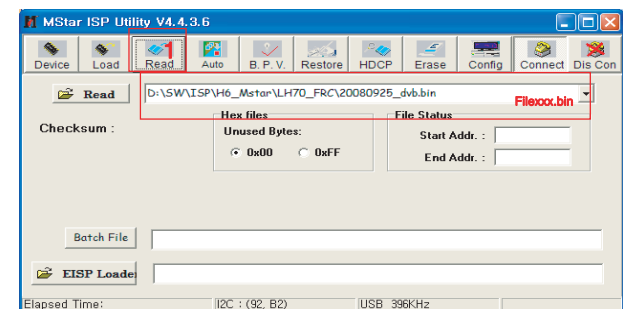

- 5) Click "(2)Auto" tab and set as below
- 6) Click "(3)Run".
- 7) After downloading, you can see the "(4)Pass" message.

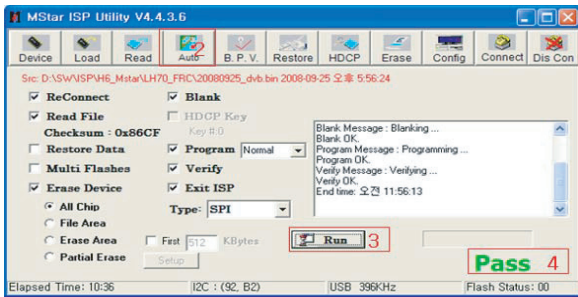

4.1.2. Using the Memory Stick

* USB download : Service Mode

- 1) Insert the USB memory stick to the ISB port.
- 2) Automatically detect the SW Version.
-> S/W download process is executed automatically.
- 3) Show the message "Copy the file from the Memory"

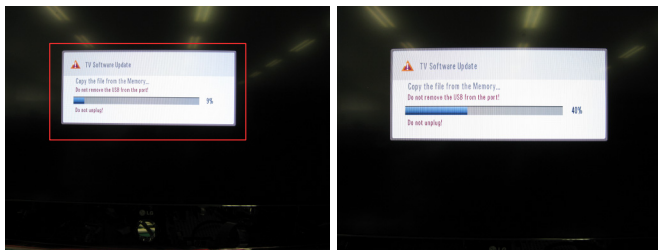

4) After Finished the Download, Automatically DC Off -> On

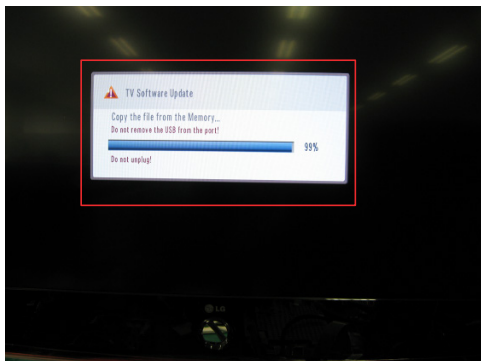

5) Check The update SW Version.

4.2. Input tool option.

Adjust tool option refer to the BOM.

- Tool Option Input : PCBA Check Process
- Area Option Input : Set Assembly Process

After Input Tool Option and AC off

Before PCBA check, you have to change the Tool option and have to AC off/on (Plug out and in)
(If missing this process, set can operate abnormally)

- (1) Profile : Must be changed the option value because being different with some setting value depend on module maker, inch and market
- (2) Equipment : adjustment remote control.

(3). Adjustment method

- The input methods are same as other chassis.(Use IN-START Key on the Adjust Remocon.)
(If not changed the option, the input menu can differ the model spec.)

Refer to Job Expression of each main chassis ass'y (EBTxxxxxxx) for Option value
Caution : Don't Press "IN-STOP" key after completing the function inspection.

4.3. EDID D/L method

Recommend that don't connect HDMI and RGB(D-SUB) cable when downloading the EDID.

If not possible, recommend that connect the MSPG equipment.
There are two methods of downloading the edid data

4.3.1. 1st Method

EDID datas are automatically downloaded when adjusting the Tool Option2.

Automatically downloaded when pushing the enter key after adjusting the tool option2.

It takes about 2seconds.

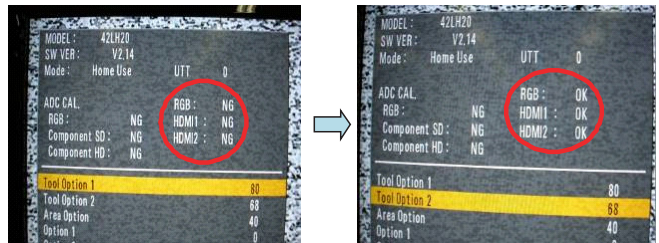

4.3.2. 2nd Method

* Caution :

Must be checked that the tool option is right or not.

If tool option is wrong, hdmi edid data could not be downloaded well.

- 1) Press the ADJ key
- 2) Move to the EDID D/L and Press the right direction key(▶)
- 3) Press the right direction key(▶) at Start.
- 4) After about a few seconds, appear "OK", then comple.

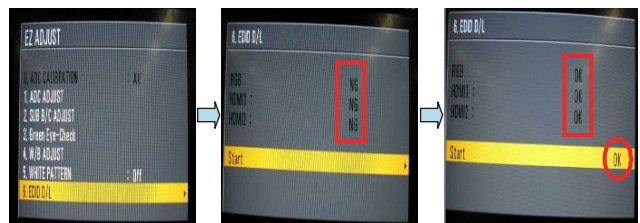

4.3.3. RS-232C command Method

(1) Command : AE 00 10

* Caution

Don't connect HDMI and RGB(D-SUB) cable when downloading the EDID.

If the cables are connected, Downloading of edid could be failed.

4.3.4. EDID data

(1) Analog(RGB): 128bytes>

Addr	00	01	02	03	04	05	06	07	08	09	0A	0B	0C	0D	0E	0F
0000	00	FF	FF	FF	FF	FF	FF	00	1E	6D	A1	C3	01	01	01	01
0010	1B	12	01	03	08	46	27	78	0A	D9	B0	A3	57	49	9C	25
0020	11	49	4B	A1	08	00	81	80	45	40	61	40	01	01	01	01
0030	01	01	01	01	01	01	1A	36	80	A0	70	38	1F	40	30	20
0040	35	00	E8	26	32	00	00	1A	1B	21	50	A0	51	00	1E	30
0050	48	88	35	00	BC	88	21	00	00	1C	00	00	00	FC	00	4C
0060	47	20	54	56	0A	20	20	20	20	20	20	20	20	00	00	FD
0070	00	3A	3F	1C	44	0F	00	0A	20	20	20	20	20	20	00	46

(2) HDMI 1 : 256Bytes

Addr	00	01	02	03	04	05	06	07	08	09	0A	0B	0C	0D	0E	0F
0000	00	FF	FF	FF	FF	FF	FF	00	1E	6D	A2	C3	01	01	01	01
0010	1B	12	01	03	80	46	27	78	0A	D9	B0	A3	57	49	9C	25
0020	11	49	4B	21	08	00	01	01	45	40	61	40	01	01	81	80
0030	01	01	D1	C0	01	01	02	3A	80	18	71	38	2D	40	58	2C
0040	45	00	08	44	21	00	00	1E	1B	21	50	A0	51	00	1E	30
0050	48	88	35	00	BC	88	21	00	00	1C	00	00	00	FC	00	4C
0060	47	20	54	56	0A	20	20	20	20	20	20	20	20	00	00	FD
0070	00	3A	3F	1C	44	0F	00	0A	20	20	20	20	20	20	01	D5
0080	02	03	25	F1	4F	90	07	01	16	02	03	11	12	13	04	14
0090	05	20	22	1F	23	09	07	07	83	01	00	00	68	03	0C	00
00A0	10	00	B8	2D	00	01	1D	00	80	51	D0	1C	20	40	80	35
00B0	00	BC	88	21	00	00	1E	8C	0A	D0	8A	20	E0	2D	10	10
00C0	3E	96	00	13	8E	21	00	00	18	8C	0A	A0	14	51	F0	16
00D0	00	26	7C	43	00	C4	8E	21	00	00	98	01	1D	80	18	71
00E0	1C	16	20	58	2C	25	00	C4	8E	21	00	00	9E	00	00	00
00F0	00	00	00	00	00	00	00	00	00	00	00	00	00	00	00	E3

(3) HDMI 2 : 256Bytes

Addr	00	01	02	03	04	05	06	07	08	09	0A	0B	0C	0D	0E	0F
0000	00	FF	FF	FF	FF	FF	FF	00	1E	6D	A2	C3	01	01	01	01
0010	1B	12	01	03	80	46	27	78	0A	D9	B0	A3	57	49	9C	25
0020	11	49	4B	21	08	00	01	01	45	40	61	40	01	01	81	80
0030	01	01	D1	C0	01	01	02	3A	80	18	71	38	2D	40	58	2C
0040	45	00	08	44	21	00	00	1E	1B	21	50	A0	51	00	1E	30
0050	48	88	35	00	BC	88	21	00	00	1C	00	00	00	FC	00	4C
0060	47	20	54	56	0A	20	20	20	20	20	20	20	20	00	00	FD
0070	00	3A	3F	1C	44	0F	00	0A	20	20	20	20	20	20	01	D5
0080	02	03	25	F1	4F	90	07	01	16	02	03	11	12	13	04	14
0090	05	20	22	1F	23	09	07	07	83	01	00	00	68	03	0C	00
00A0	20	00	B8	2D	00	01	1D	00	80	51	D0	1C	20	40	80	35
00B0	00	BC	88	21	00	00	1E	8C	0A	D0	8A	20	E0	2D	10	10
00C0	3E	96	00	13	8E	21	00	00	18	8C	0A	A0	14	51	F0	16
00D0	00	26	7C	43	00	C4	8E	21	00	00	98	01	1D	80	18	71
00E0	1C	16	20	58	2C	25	00	C4	8E	21	00	00	9E	00	00	00
00F0	00	00	00	00	00	00	00	00	00	00	00	00	00	00	00	D3

(4) HDMI 3 : 256Bytes

Addr	00	01	02	03	04	05	06	07	08	09	0A	0B	0C	0D	0E	0F
0000	00	FF	FF	FF	FF	FF	FF	00	1E	6D	A2	C3	01	01	01	01
0010	1B	12	01	03	80	46	27	78	0A	D9	B0	A3	57	49	9C	25
0020	11	49	4B	21	08	00	01	01	45	40	61	40	01	01	81	80
0030	01	01	D1	C0	01	01	02	3A	80	18	71	38	2D	40	58	2C
0040	45	00	08	44	21	00	00	1E	1B	21	50	A0	51	00	1E	30
0050	48	88	35	00	BC	88	21	00	00	1C	00	00	00	FC	00	4C
0060	47	20	54	56	0A	20	20	20	20	20	20	20	20	00	00	FD
0070	00	3A	3F	1C	44	0F	00	0A	20	20	20	20	20	20	01	D5
0080	02	03	25	F1	4F	90	07	01	16	02	03	11	12	13	04	14
0090	05	20	22	1F	23	09	07	07	83	01	00	00	68	03	0C	00
00A0	30	00	B8	2D	00	01	1D	00	80	51	D0	1C	20	40	80	35
00B0	00	BC	88	21	00	00	1E	8C	0A	D0	8A	20	E0	2D	10	10
00C0	3E	96	00	13	8E	21	00	00	18	8C	0A	A0	14	51	F0	16
00D0	00	26	7C	43	00	C4	8E	21	00	00	98	01	1D	80	18	71
00E0	1C	16	20	58	2C	25	00	C4	8E	21	00	00	9E	00	00	00
00F0	00	00	00	00	00	00	00	00	00	00	00	00	00	00	00	C3

4.4. ADC Calibration

4.4.1. ADC Calibration - Component (Using External pattern)

- (1) Required Equipments
 - Remote controller for adjustment
 - MSPG-925F/MSPG-1025/MSPG-3233 Pattern Generator
- (2) Process
 - 1) Change the Input to Component1 or 2 mode.
 - 2) Input the Component 480i@60Hz 100% Color Bar YPbPr signal into Component1 or 2. (MSPG-925F Model: 209 / Pattern: 65)

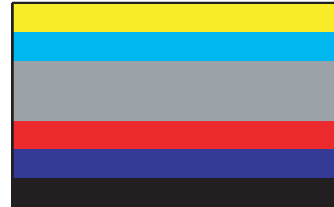

- 3) Press ADJ key on R/C for adjustment.
- 4) Enter Password number. Password is "0 0 0 0".
- 5) Select "0. ADC calibration : Component" by using ▲/▼ (CH +/-) and press ENTER(■).
- 6) ADC adjustment is executed automatically .
- 7) When ADC adjustment is finished, this OSD appear



4.4.2. ADC Calibration - RGB (Using External pattern)

- (1) Required Equipments
 - Remote controller for adjustment
 - MSPG-925F/MSPG-1025/MSPG-3233 Pattern Generator
- (2) Process
 - 1) Change the Input to RGB mode..
 - 2) Input the PC 1024x768@60Hz Horizontal Color Bar signal into RGB. (MSPG-925F Model: 60 / Pattern: 65)

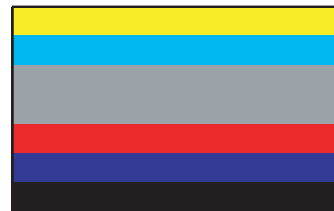

- 3) Press ADJ key on R/C for adjustment.
- 4) Enter Password number. Password is "0 0 0 0".
- 5) Select "0. ADC calibration : RGB" by using ▲/▼(CH +/-) and press ENTER(■).
- 6) ADC adjustment is executed automatically .
- 7) When ADC adjustment is finished, this OSD appear



4.5. Check SW Version

- (1) Method
 - 1) Push In-star key on Adjust remote-controller.
 - 2) SW Version check
- Check "SW VER : V3.xx" – LH70

LP91A	LPL L42FHD
S/W Ver 3.XX	Bluetooth 3.XX
UTT 97	00 HDCP 0
SHOP Mode : auto home	
ADC CAL.	
RGB :	OK
Component SD :	OK
Component SD :	OK
Tool Option1	39848
Tool Option2	51
Area Option	1
OPTION1	43
OPTION2	46
OPTION3	0
OPTION4	0
System Control	
Audio Prescale	
Threshold	
Power Off History	
Panel Control	
Davinci / Auto Test	

5. PCB assembly adjustment method

5.1. Input Area-Option

- (1) Profile : Must be changed the Area option value because being different of each Country's Language and signal Condition.
- (2) Equipment : adjustment remote control.
- (3) Adjustment method
 - The input methods are same as other chassis.(Use IN-START Key on the Adjust Remocon.)

Refer to Job Expression of each main chassis ass'y (EBTxxxxxxx) for Option value.

* White Balance Adjustment

- Purpose : Adjust the color temperature to reduce the deviation of the module color temperature.
- Principle : To adjust the white balance without the saturation, Fix the one of R/G/B gain to 192 (default data) and decrease the others.
- Adjustment mode : Three modes – Cool / Medium / Warm
- Required Equipment
 - 1) Remote controller for adjustment
 - 2) Color Analyzer : CA100+ or CA-210 or same product - LCD TV(ch : 9),
(should be used in the calibrated ch by CS-1000)
 - 3) Auto W/B adjustment instrument(only for Auto adjustment)

5.2. Adjustment of White Balance

: (For automatic adjustment)

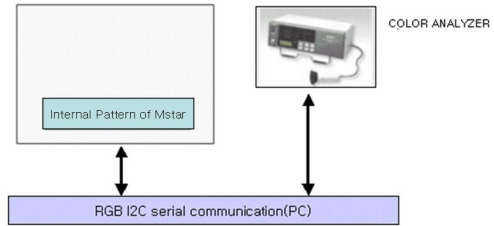

* LP91A~D Support RS-232C & I2C DDC Communication-White Balance Mode.

- (1) Enter the adjustment mode of DDC
 - Set command delay time : 50ms
 - Enter the DDC adjustment mode at the same time heat-run mode when pushing the power on by power only key
 - Maintain the DDC adjustment mode with same condition of Heat-run => Maintain after AC off/on in status of Heat-run pattern display)
 - (2) Release the DDC adjustment mode
 - Release the adjust mode after AC off/on or std-by off/on in status of finishing the Hear-run mode
 - Release the Adjust mode when receiving the aging off command(F3 00 00) from adjustment equipment.
 - Need to transmit the aging off command to TV set after finishing the adjustment.
 - Check DDC adjust mode release by exit key and release DDC adjust mode)
 - (3) Enter the adjust mode of white balance)
 - Enter the white balance adjustment mode with aging command (F3, 00, FF)
- * Luminance min value is 150cd in the Cool/Medium/Warm mode(For LCD)

5.3. Adjustment of White Balance

(for Manual adjustment)

- (1) Color analyzer(CA100+, CA210) should be used in the calibrated ch by CS-1000
- (2) Operate the zero-calibration of the CA100+ or CA-210, then stick sensor to the module when adjusting.
- (3) For manual adjustment, it is also possible by the following sequence.
 - 1) Select white pattern of heat-run by pressing "POWER ON" key on remote control for adjustment then operate heat run longer than 15 minutes. (If not executed this step, the condition for W/B may be different.)
 - 2) Push "Exit" key.
 - 3) Change to the AV mode by remote control.
 - 4) Input external pattern (85% white pattern)
 - 5) Push the ADJ key -> Enter "0000" (Password)
 - 6) Select "3. W/B ADJUST"
 - 7) Enter the W/B ADJUST Mode
 - 8) Stick the sensor to the center of the screen and select each items (Red/Green/Blue Gain and Offset) using ▲/▼(CH +/-) key on R/C..
 - 9) Adjust R/ G/ B Gain using ◀/▶(VOL +/-) key on R/C.
 - 10) Adjust three modes all (Cool / Medium / Warm) : Fix the one of R/G/B gain and change the others
 - 11) When adjustment is completed, Enter "COPY ALL".
 - 12) Exit adjustment mode using EXIT key on R/C.

* CASE

First adjust the coordinate far away from the target value(x, y).

1. $x, y > \text{target}$
 - i) Decrease the R, G.
2. $x, y < \text{target}$
 - i) First decrease the B gain,
 - ii) Decrease the one of the others.
3. $x > \text{target}, y < \text{target}$
 - i) First decrease B, so make y a little more than the target.
 - ii) Adjust x value by decreasing the R
4. $x < \text{target}, y > \text{target}$
 - i) First decrease B, so make x a little more than the target.
 - ii) Adjust x value by decreasing the G

(4) Standard color coordinate and temperature when using the CA100+ or CA210 equipment

Mode	Coordinate		Temp	uvΔ
	x	y		
Cool	0.276±0.002	0.283±0.002	11000K	0.000
Medium	0.285±0.002	0.293±0.002	9300K	0.000
Warm	0.313±0.002	0.329±0.002	6500K	0.003

To check the Coordinates of White Balance, you have to measure at the below conditions.

Picture Mode : User 1

Dynamic Contrast : Off

Dynamic Colour : Off

(If you miss the upper condition, the coordinates of W/B can be lower than the spec.)

TROUBLESHOOTING

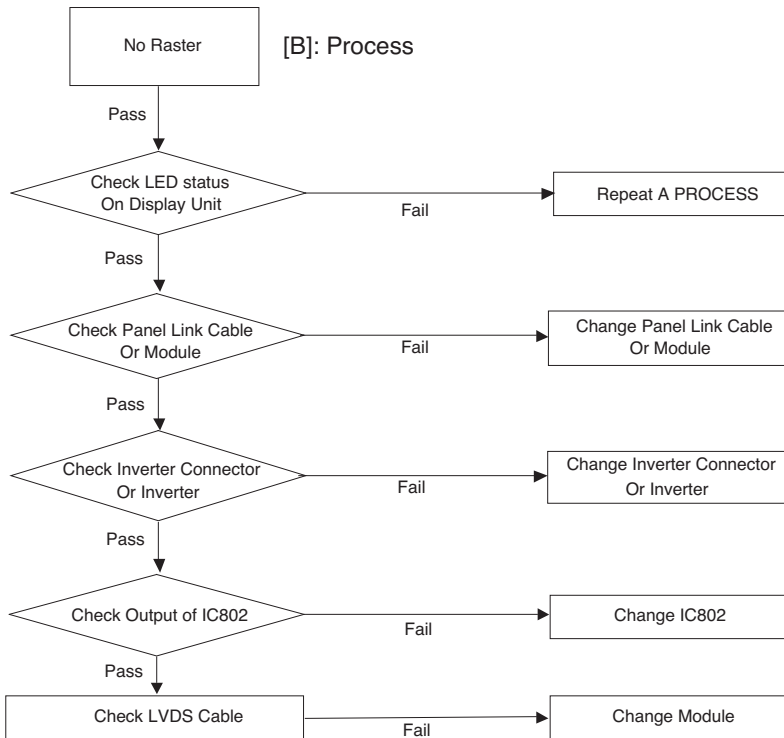
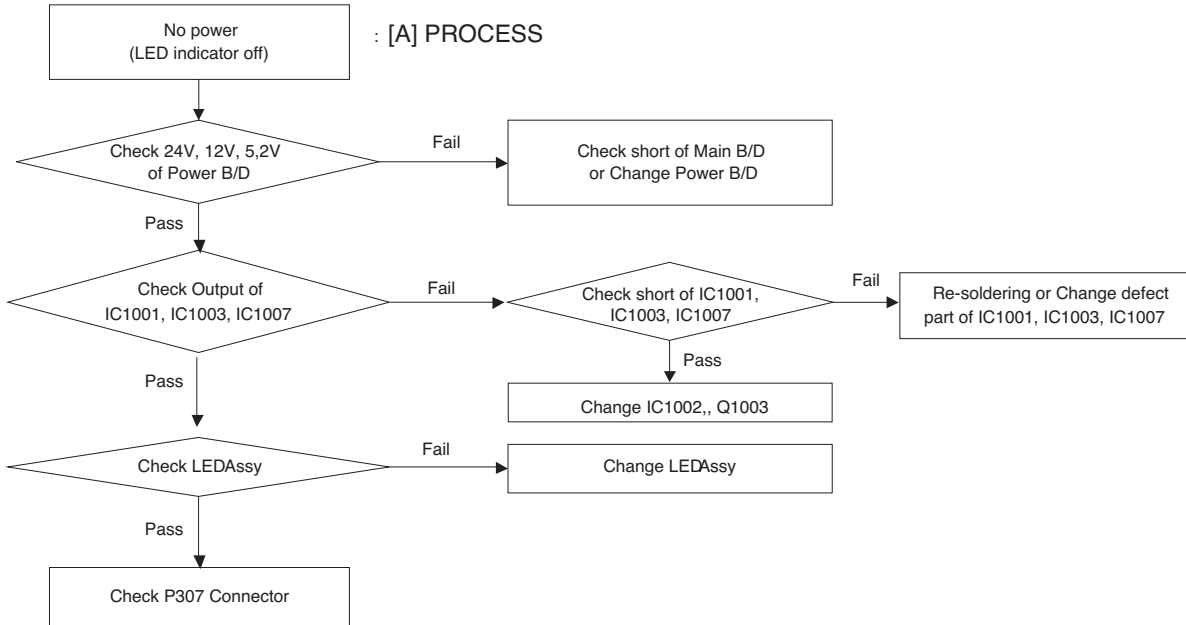

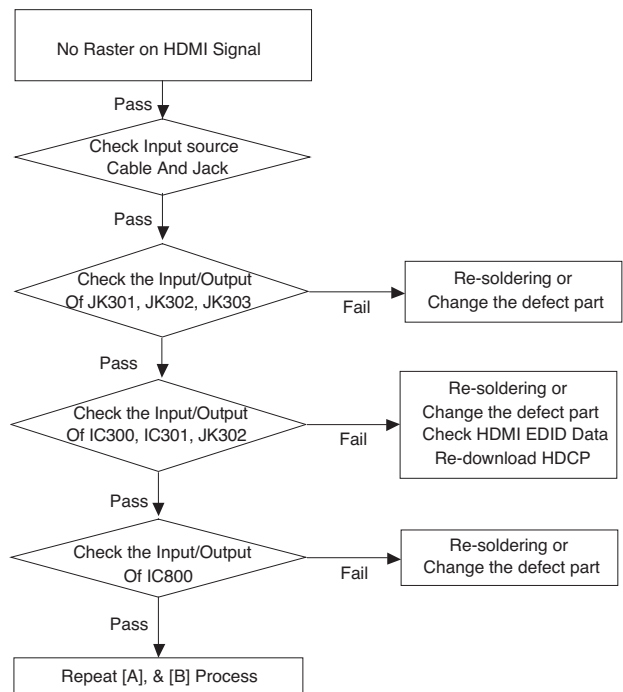
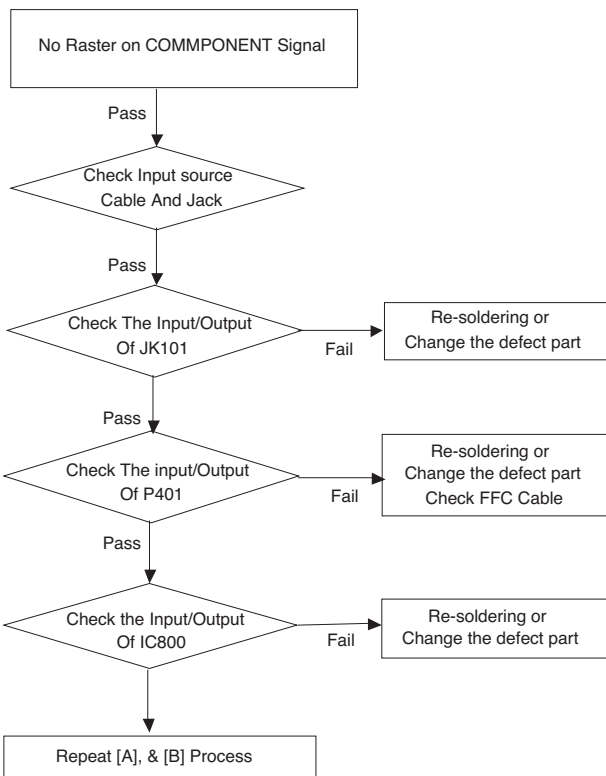
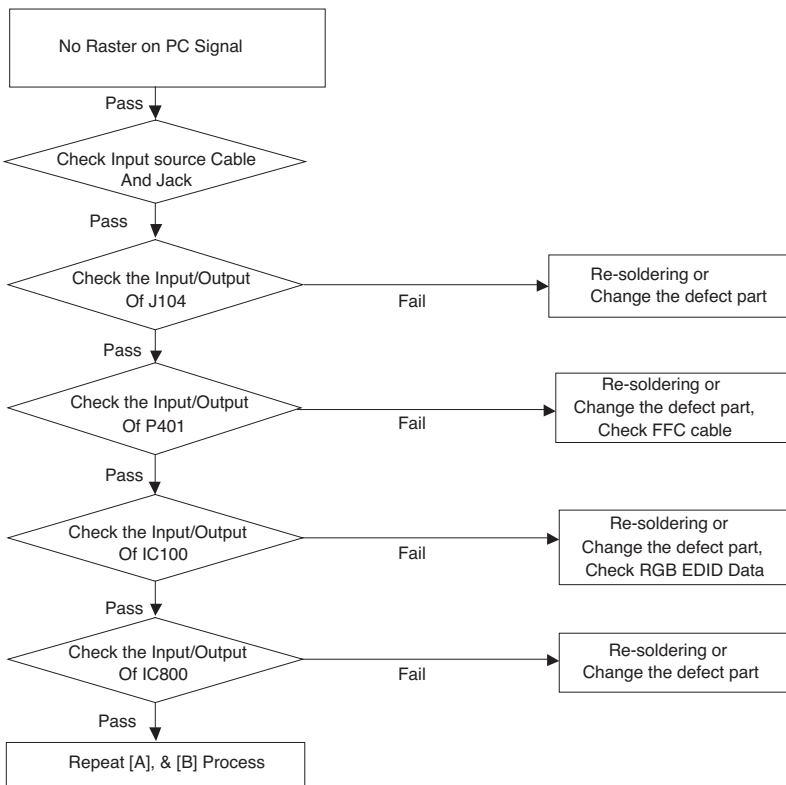

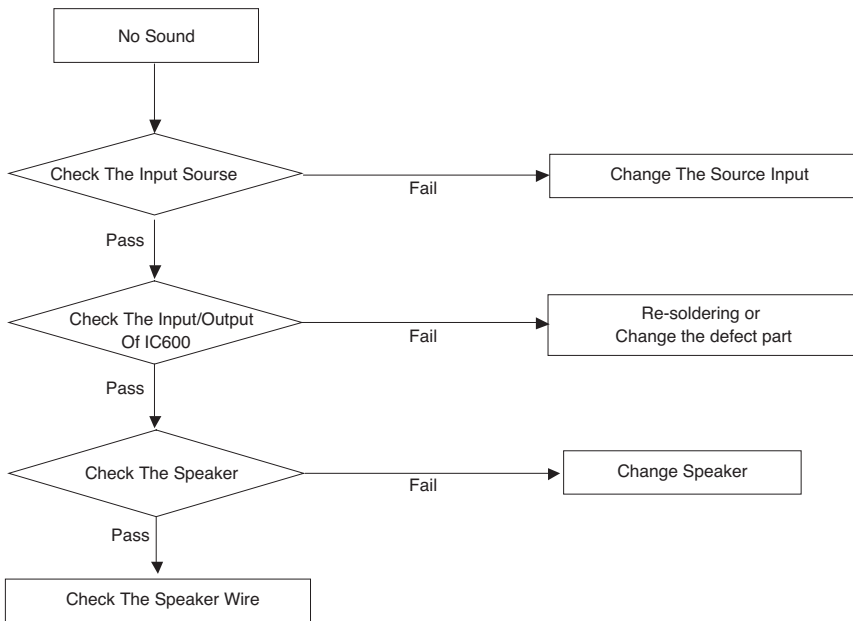
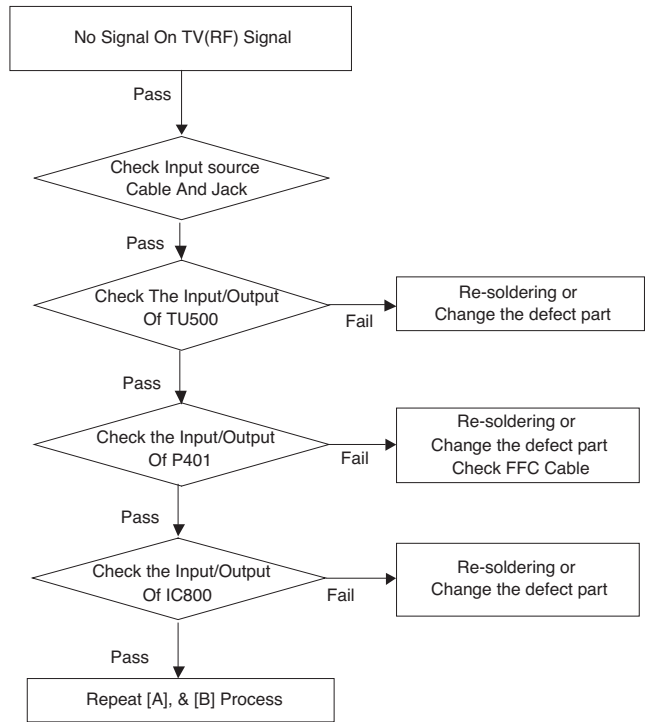
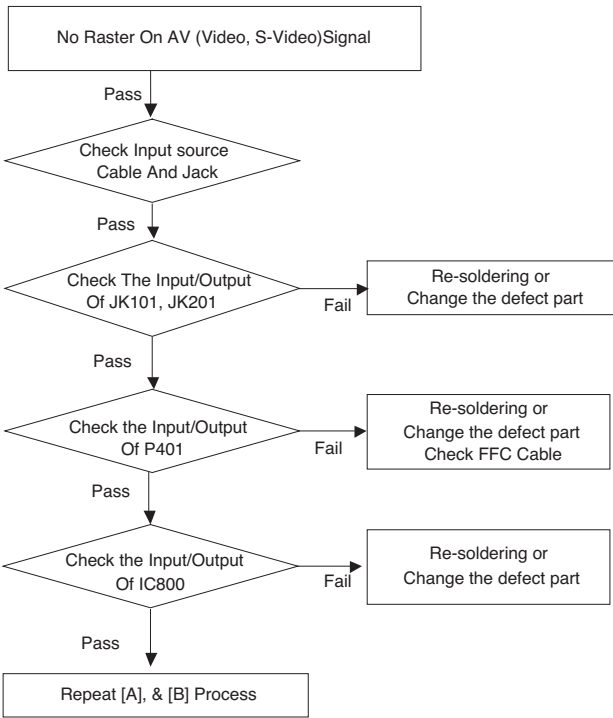

BLOCK DIAGRAM

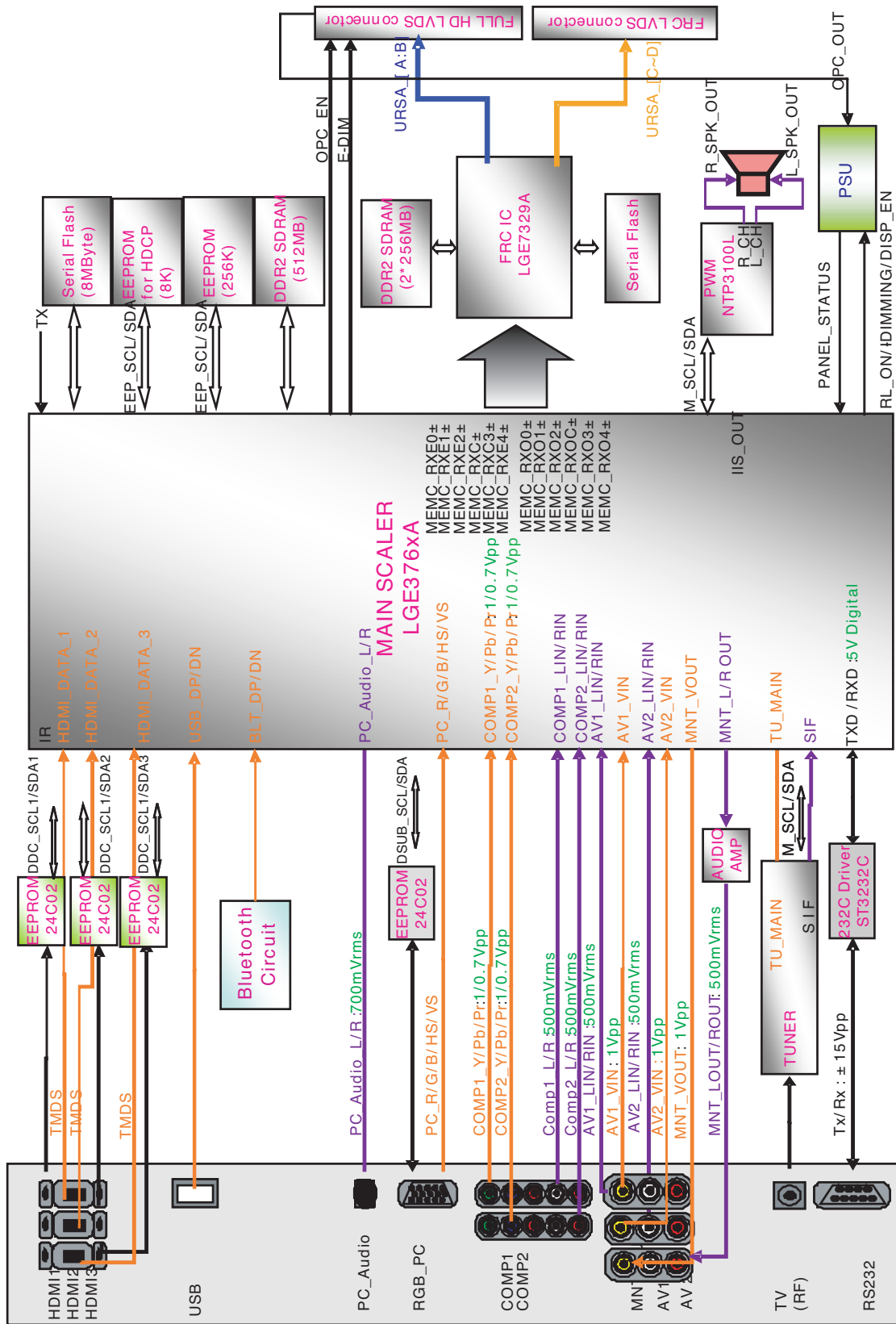

EXPLODED VIEW

IMPORTANT SAFETY NOTICE

Many electrical and mechanical parts in this chassis have special safety-related characteristics. These parts are identified by Δ in the Schematic Diagram and EXPLODED VIEW. It is essential that these special safety parts should be replaced with the same components as recommended in this manual to prevent X-RADIATION, Shock, Fire, or other Hazards. Do not modify the original design without permission of manufacturer.

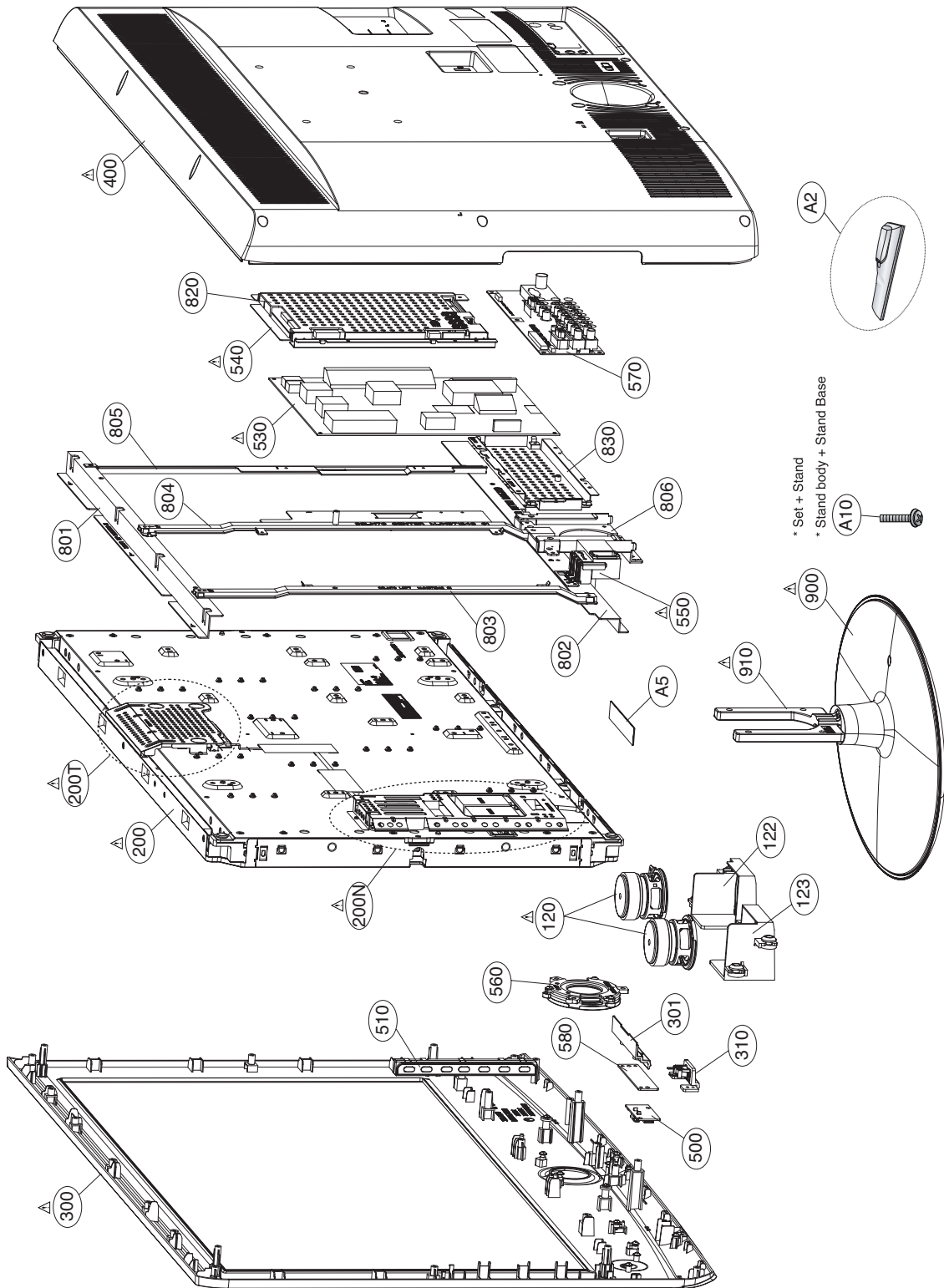

EAX58298501
Mstar LCD LH70

AMP : GAIN X 4

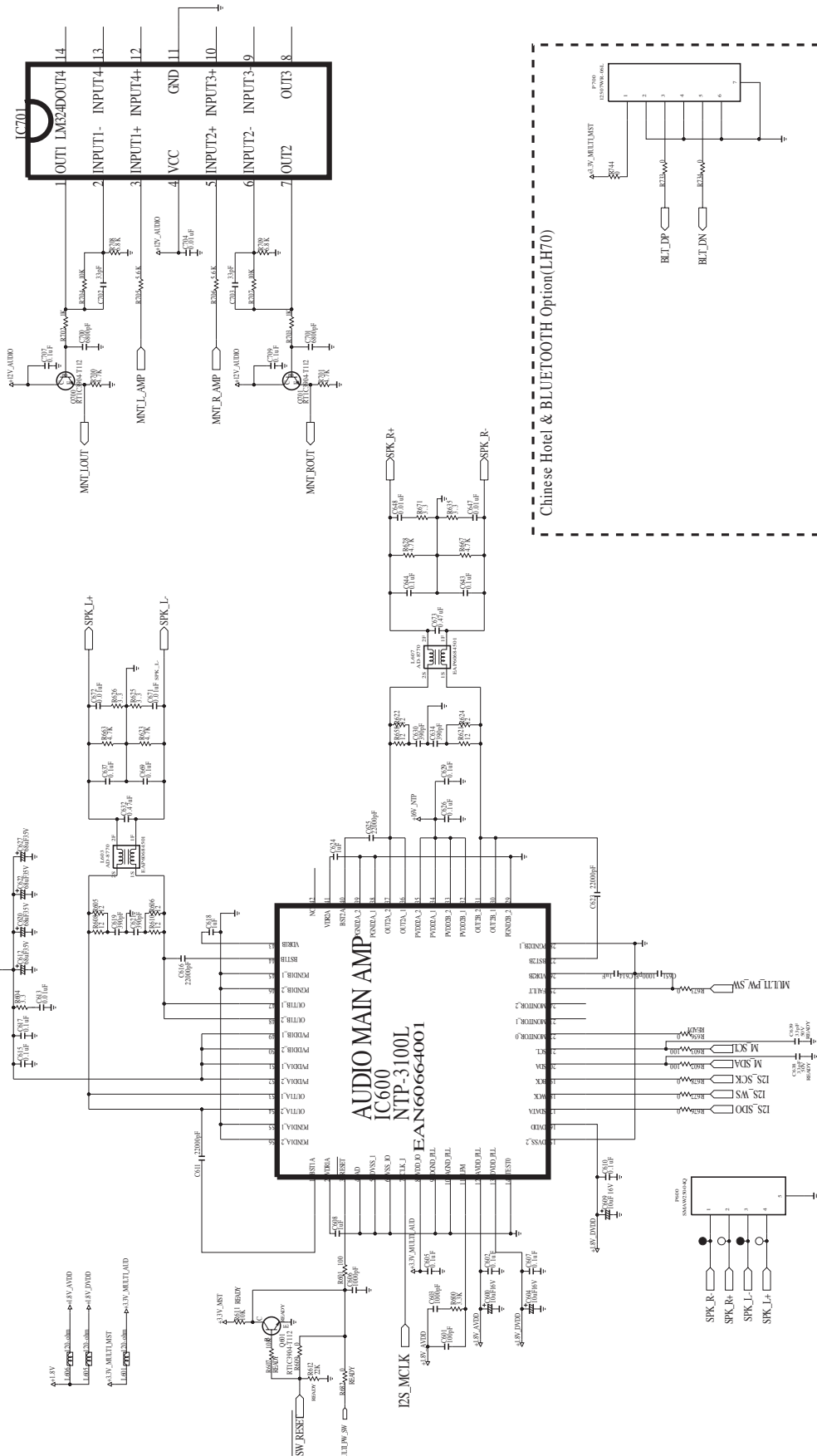

THE SYMBOL MARK OF THIS SCHEMATIC DIAGRAM INCORPORATES SPECIAL FEATURES IMPORTANT FOR PROTECTION FROM X-RADIATION, FIRE AND ELECTRICAL SHOCK HAZARDS. WHEN SERVICING IT IS ESSENTIAL THAT ONLY MANUFACTURERS SPECIFIED PARTS BE USED FOR THE CRITICAL COMPONENTS IN THE SYMBOL MARK OF THE SCHEMATIC.

SECRET
LGElectronics

LG ELECTRONICS

MODEL	H6 LH70	DATE	2008/09/20
BLOCK	AUDIO	SHEET	4 / 9

EAX58298501
Mstar LCD LH70

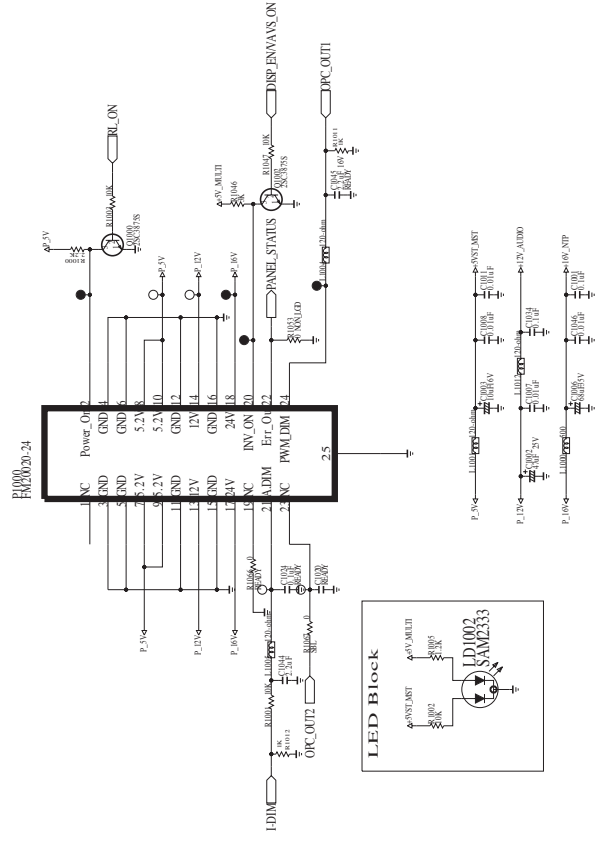

**5V_MULTI-->1.2V

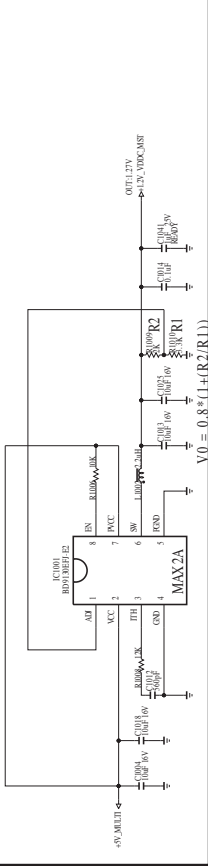

**5V_MULTI->3.3V->1.8V

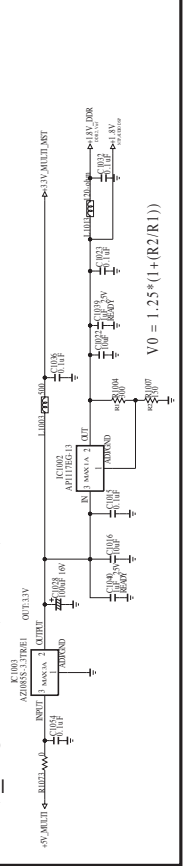

**Switch 12V:P12V
**Switch 5V:5V_MULTI -> 1.8V

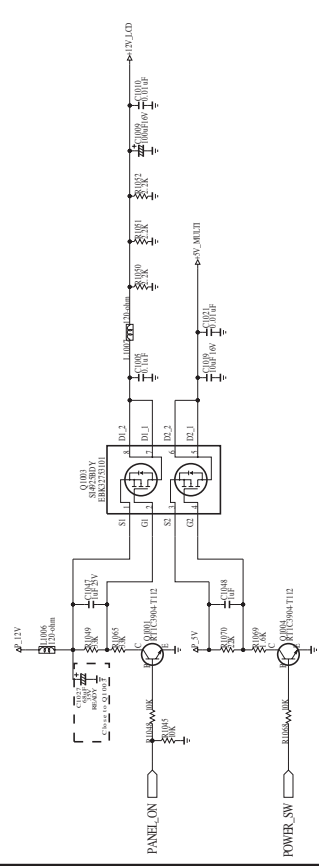

**DC-DC CONVERTER_READY
12V -> 5V_TUNER/USB

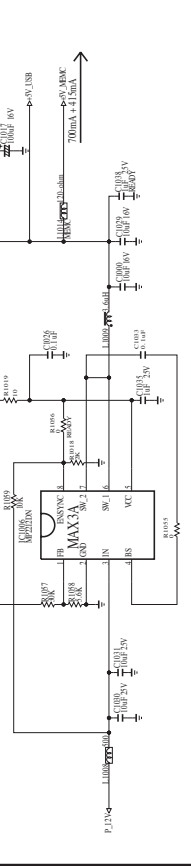

THE SYMBOL MARK OF THIS SCHEMATIC DIAGRAM INCORPORATES SPECIAL FEATURES IMPORTANT FOR PROTECTION FROM X-RADIATION, FIRE AND ELECTRICAL SHOCK HAZARDS. WHEN SERVICING, IT IS ESSENTIAL THAT ONLY MANUFACTURER SPECIFIED PARTS BE USED FOR THE CRITICAL COMPONENTS IN THE SYMBOL MARK OF THE SCHEMATIC.

SECRET
LGElectronics

LG ELECTRONICS

MODEL	H6.LH70	DATE	2008.09.20
BLOCK	POWER	SHEET	7 / 9

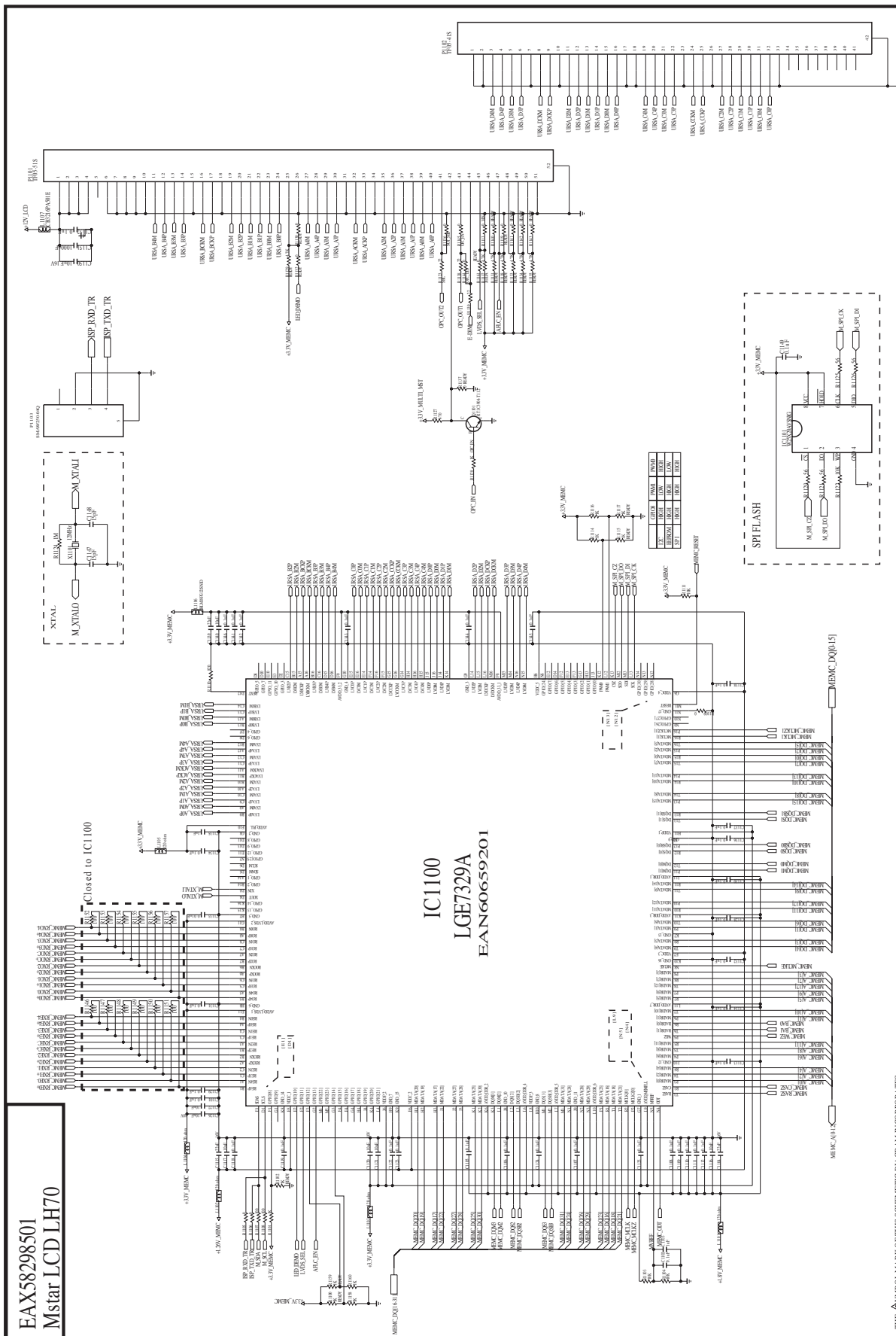

EAX58298501
Mstar LCD LH70

IC1100
LGE7329A
EAN60659201

THE SYMBOL MARK OF THIS SCHEMATIC DIAGRAM INCORPORATES
 LG ELECTRONICS' TRADE MARK AND IS A REGISTERED TRADE MARK.
 FIBRE AND ELECTRICAL SHOCK HAZARDS. WHEN SERVICING THIS IS
 ESSENTIAL THAT ONLY MANUFACTURER SPECIFIED PARTS BE USED FOR
 THE CRITICAL COMPONENTS IN THE SYMBOL MARK OF THE SCHEMATIC.

SECRET
 LG Electronics

LG ELECTRONICS

MODEL H6 LH70
 BLOCK MEMC & LVDS Out
 DATE 2008.09.20
 SHEET 8 / 9

EAX58298501
Mstar LCD LH70

43.3V_MEMC
1300 mA @ 85% efficiency

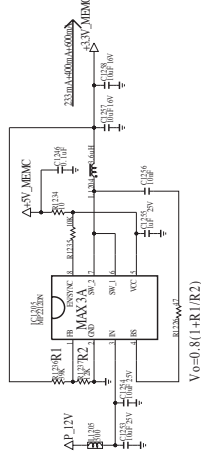

41.8V_MEMC for DDR
1000 mA @ 85% efficiency

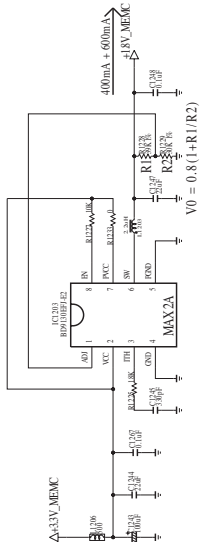

41.26V Core for MEMC

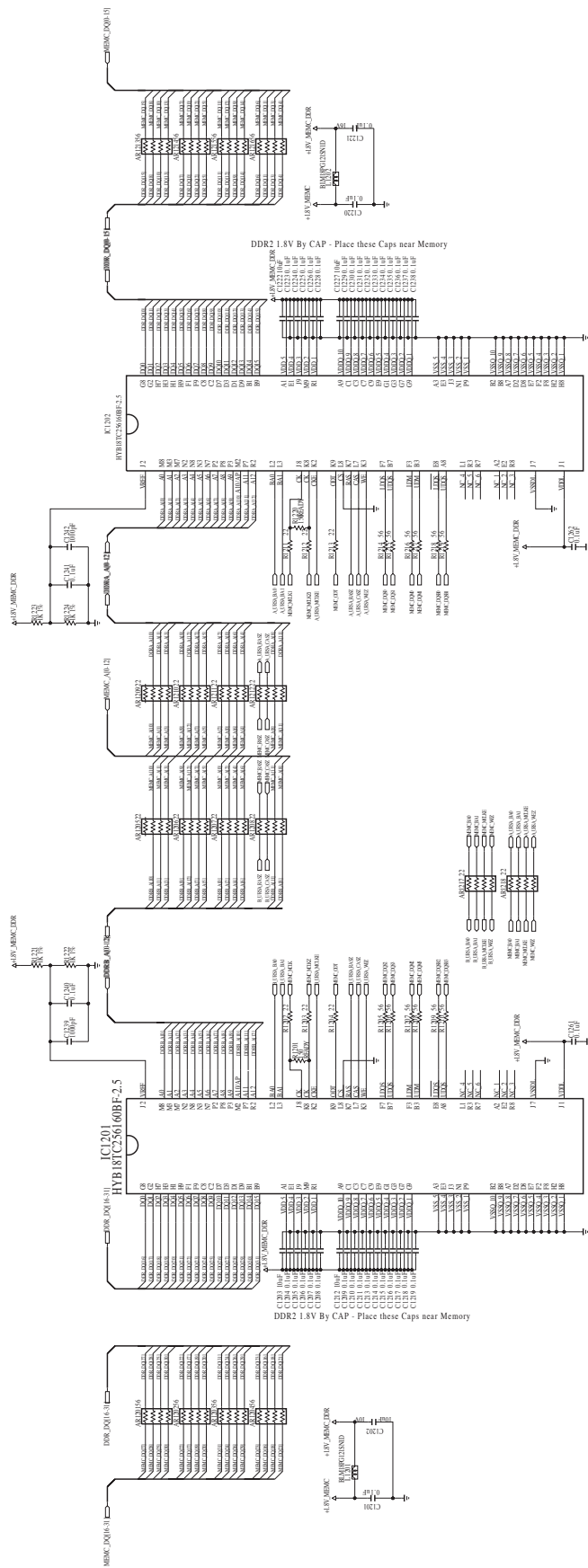
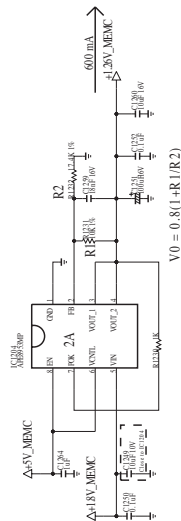

THE SYMBOL MARK OF THIS SCHEMATIC DIAGRAM INCORPORATES
FIBRE AND ELECTRICAL CHECK HAZARDS. WHEN SERVICING IS
ESSENTIAL THAT ONLY MANUFACTURER SPECIFIED PARTS BE USED FOR
THE CRITICAL COMPONENTS IN THE SYMBOL MARK OF THE SCHEMATIC.

SECRET
LGElectronics

LG ELECTRONICS

MODEL I6 LH70 DATE 2008.09.20
BLOCK MEMC_DDR & POWER SHEET 9 / 9

INTERFACE

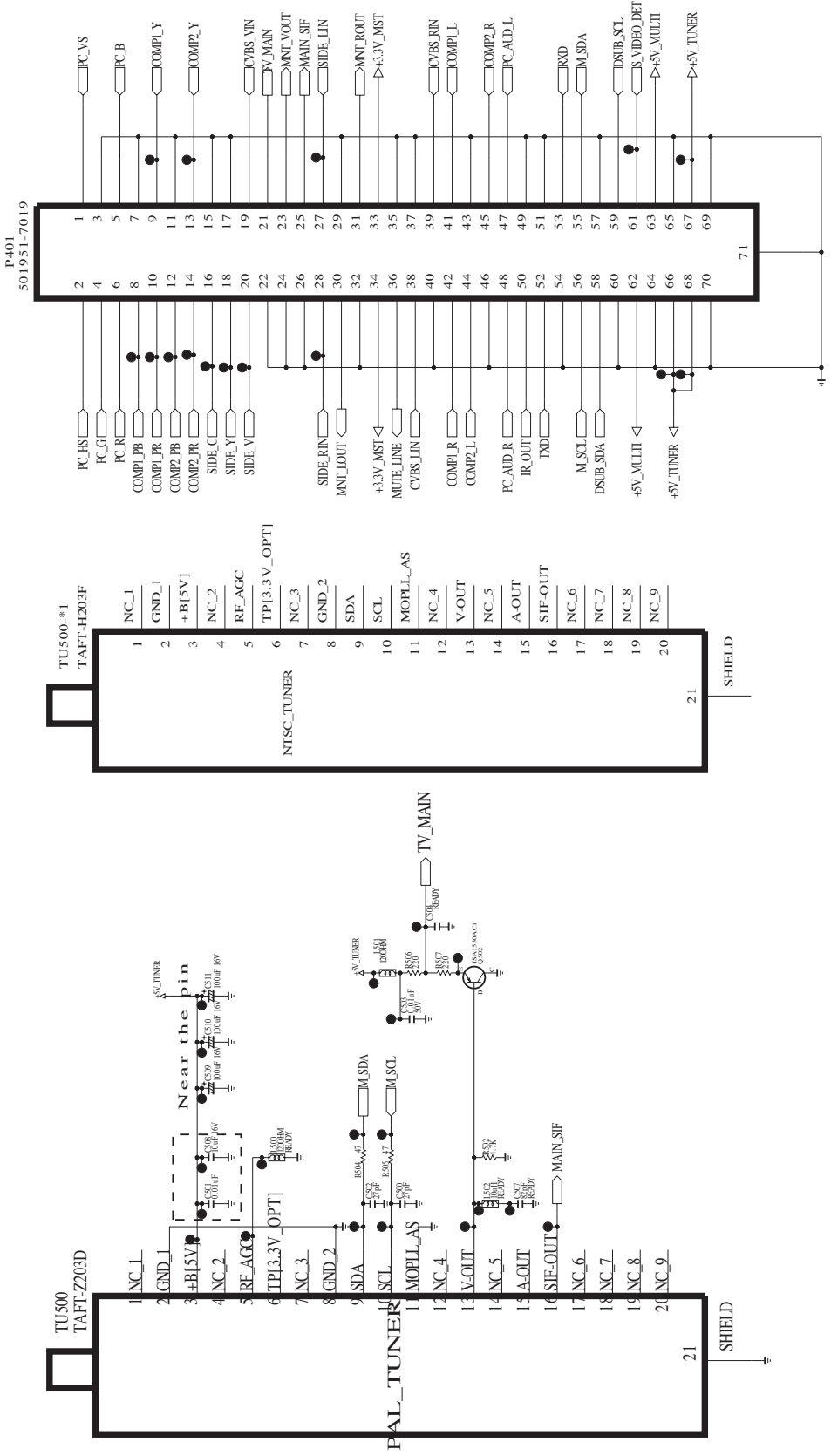

THE SYMBOL MARK OF THIS SCHEMATIC DIAGRAM INCORPORATES SPECIAL FEATURES IMPORTANT FOR PROTECTION FROM X-RADIATION, FILRE AND ELECTRICAL SHOCK HAZARDS. WHEN SERVING IF IS ESSENTIAL THAT ONLY MANUFACTURES SPECHE PARTS BE USED FOR THE CRITICAL COMPONENTS IN THE SYMBOL MARK OF THE SCHEMATIC.

SECRET
LGElectronics

LG ELECTRONICS

MODEL	MStar	DATE	2008. 5. 20
BLOCK	TUNER	SHEET	1 / 2

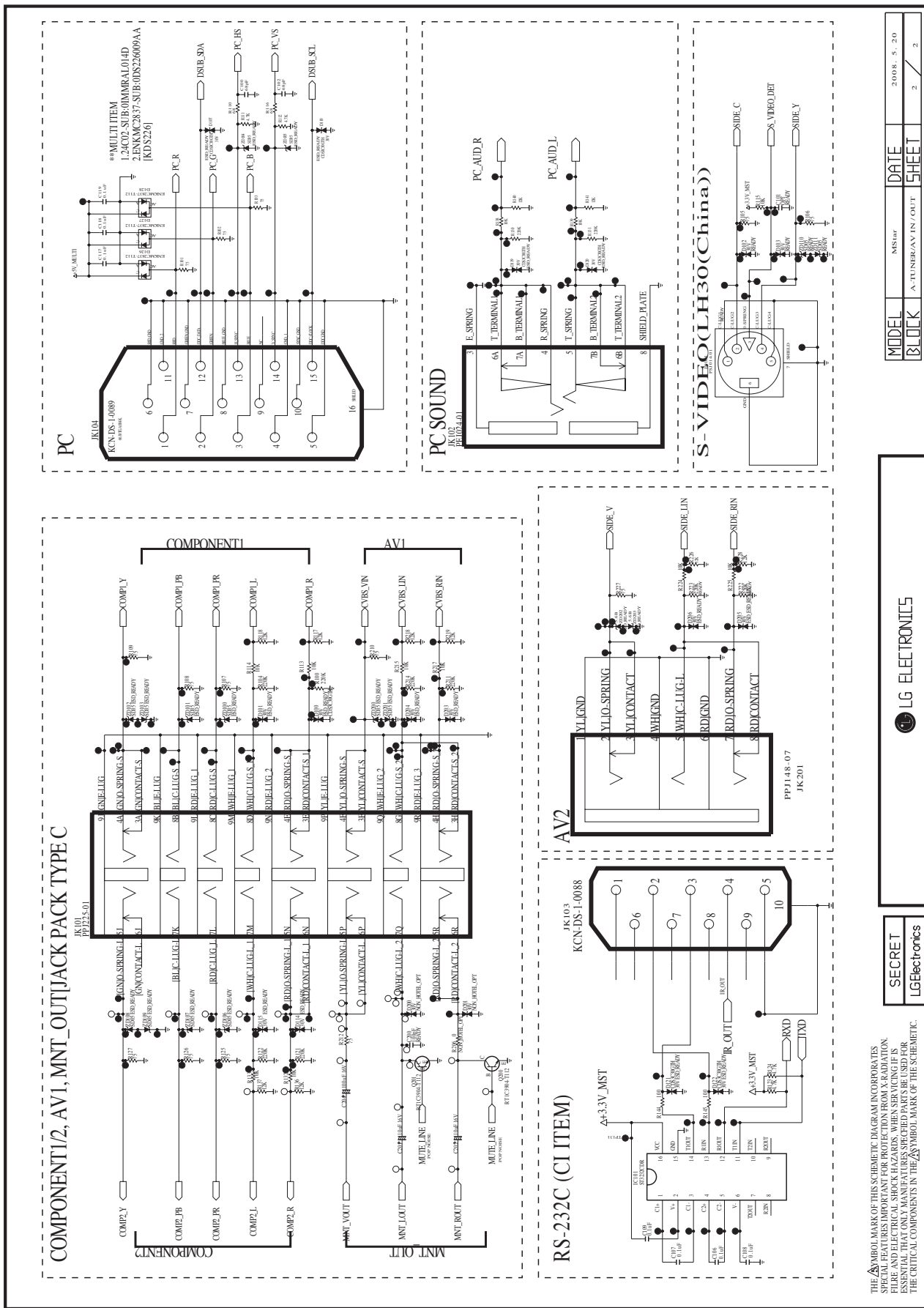



P/NO : MFL60021524

Feb., 2009
Printed in Korea

