

JVC

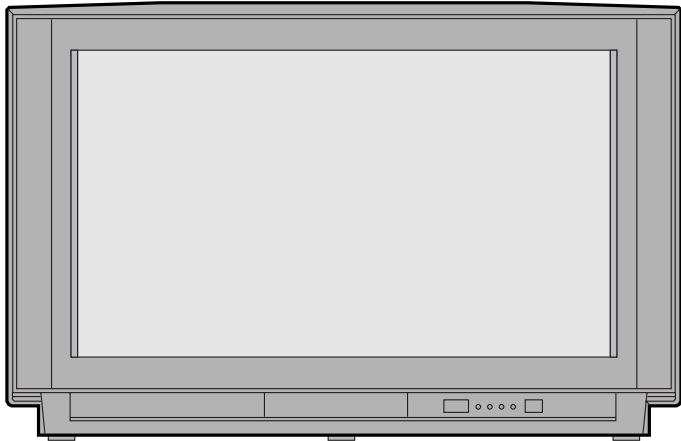

COLOUR TELEVISION

AV-32WFT1EK AV-28WFT1EK



InteriArt

Natural Vision

T-V LINK

CONTENTS

SAFETY PRECAUTIONS	2
PREPARATION	4
T-V LINK FUNCTIONS	7
BASIC OPERATION	8
REMOTE CONTROL BUTTONS AND FUNCTIONS .	11
MENU OPERATION	16
PICTURE SETTING	17
PICTURE FEATURES	18
SOUND SETTING	20
EXT SETTING	21
FEATURES	23
INSTALL	25
DEMO	29
ADDITIONAL MENU OPERATIONS	30
ADDITIONAL PREPARATION	32
TV BUTTONS AND PARTS	34
TROUBLESHOOTING	35
SPECIFICATIONS	Back cover

INSTRUCTIONS



Thank you for buying this **JVC** colour television.

To make sure your fully understand how to use your new TV, please read this manual thoroughly before you begin.

SAFETY PRECAUTIONS

■ Warning

TO PREVENT FIRE OR SHOCK HAZARD, DO NOT EXPOSE THIS APPLIANCE TO RAIN OR MOISTURE.

■ Caution

TO ENSURE PERSONAL SAFETY, OBSERVE THE FOLLOWING RULES REGARDING THE USE OF THIS UNIT.

- 1 Operate only from the power source specified (AC 220 – 240 V, 50 Hz) on the unit.
- 2 Avoid damaging the AC plug and power cord.
- 3 Avoid improper installation and never position the unit where good ventilation is unattainable.
When installing this television, distance recommendations must be maintained between the floor and wall, as well as instalment in a tightly enclosed area or piece of furniture. Please adhere to the minimum distance guidelines shown for safe operation.

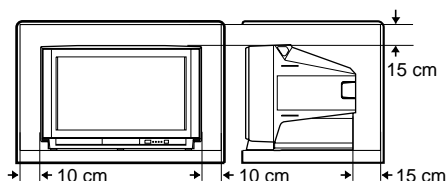

- 4 Do not allow objects or liquid into the cabinet openings.
- 5 In the event of a fault, unplug the unit and call a service technician. Do not attempt to repair it yourself or remove the rear cover.
- 6 For AV-32WFT1EK only:
The surface of the TV screen is coated with a thin film, which can easily be damaged. Be very careful with it when handling the TV.
Should the TV screen become soiled, wipe it with a soft dry cloth. Never rub it forcefully. Never use any cleaner or detergent on it.
- 7 When you don't use this TV set for a long period of time, be sure to disconnect the power plug from the AC outlet.
- 8 Do not hold the front panel door when moving the TV, if you do you may break it.

■ Warning

DO NOT cut off the mains plug from this equipment. If the plug fitted is not suitable for the power points in your home or the cable is too short to reach a power point, then obtain an appropriate safety approved extension lead or adaptor or consult your dealer.

If nonetheless the mains plug is cut off, remove the fuse and dispose of the plug immediately, to avoid a possible shock hazard by inadvertent connection to the mains supply.

If a new mains plug has to be fitted, then follow the instruction given below:

IMPORTANT

DO NOT make any connection to the larger terminal which is marked with the letter E or by the safety earth symbol \perp or coloured green or green-and-yellow.

The wires in the mains lead on this product are coloured in accordance with the following code:

Blue: Neutral
Brown: Live

As these colours may not correspond with the coloured marking identifying the terminals in your plug proceed as follows:

The wire which is coloured blue must be connected to the terminal which is marked with the letter N or coloured black.

The wire which is coloured brown must be connected to the terminal which is marked with the letter L or coloured red.

When replacing the fuse only a correctly rated approved type should be used and be sure to re-fit the fuse cover.

IF IN DOUBT — CONSULT A COMPETENT ELECTRICIAN.

How To Replace The Fuse

Open the fuse compartment with a blade screwdriver, and replace the fuse.

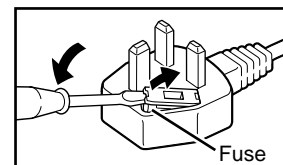

■ Guidelines for Safe Operation

This equipment has been designed and manufactured to comply with international safety standards. However, as with any electrical appliance, care must be taken to ensure optimal results and operational safety.

- Before attempting to use this equipment, read the operating instructions thoroughly.
- Ensure that all electrical connections (including the mains plug, extension leads, etc.) have been made in accordance with the manufacturer's instructions.
- If ever in doubt about the installation, operation or safety of this equipment, consult your dealer.
- Handle all glass panels or covers with care.
- Never operate this equipment if it appears damaged or operates abnormally. Turn the power off, disconnect the main power plug and consult your dealer.
- Never remove any affixed panels or covers. Doing so may result in electrical shock.
- Never leave this equipment operating unattended unless otherwise specifically stated that it is designed to do so or in standby mode. Only use the designated power switch to turn off the power and ensure that all potential users are instructed how to do so. Make special arrangements for infirm or handicapped persons.
- Never watch TV while operating a motor vehicle. It is illegal to watch TV while driving.
- Never listen to headphones at high volume. Doing so may damage your hearing.
- Never obstruct the ventilation of this equipment. Doing so may cause overheating and result in a malfunction or damage.
- Never use makeshift stands or attempt to affix legs with wood screws. When using a manufacturer's approved stand or legs, use only the fixtures provided and follow the installation instructions.
- Never allow this equipment to be exposed to rain or moisture.
- Never allow anyone, especially children, to insert anything into an opening in the case. Doing so may result in a fatal electrical shock.
- Never guess or take chances with electrical equipment of any kind. It is better to be safe than sorry.

PREPARATION

www.DataSheet4U.com

■ Connecting the Aerial and VCR

If connecting a VCR, follow (A) → (B) → (C) → (D).
If not connecting a VCR, follow ① → ②.

*1: To operate T-V LINK functions, a T-V LINK compatible VCR must be connected to the EXT-2 terminal on the TV. For details about T-V LINK functions, see "T-V LINK FUNCTIONS" on page 7.

Note:

- For further details, refer to the manuals provided with the devices to be connected.
- The connecting cables are not provided.
- A video can be viewed from the VCR without performing (C). For details, refer to your VCR instruction manual.
- To connect additional external devices, please see "ADDITIONAL PREPARATION" on page 32.
- To connect external speakers and audio system, please see "Connecting Speakers/Amplifier" on page 33.
- When a decoder is connected to a T-V LINK compatible VCR, set the DECODER (EXT-2) function to ON. For details, see "Using the DECODER (EXT-2) function" on page 30. Otherwise, you will not be able to view scrambled channels.

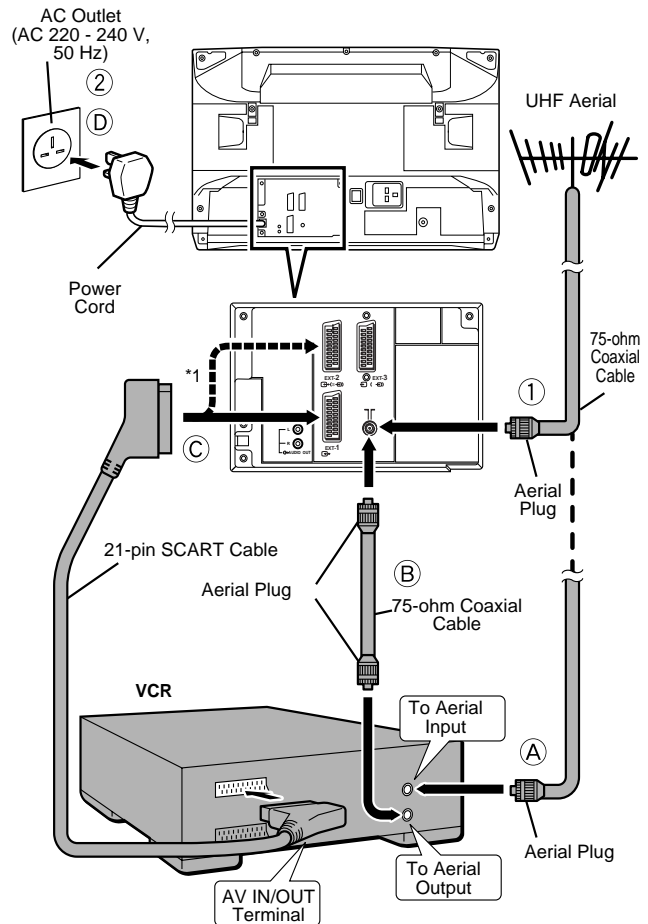

■ Putting Batteries into the Remote Control

Use two AAA/R03 dry cell batteries.

Insert the batteries from the ⊖ end, making sure the ⊕ and ⊖ polarities are correct.

To open the battery compartment, slide the door downwards and lift off. Replace the door by sliding it upwards until it is secure.

Note:

- Follow the warnings printed on the batteries.
- Battery life is about six months to one year, depending on your frequency of use.
- If the remote control does not work properly, replace the batteries.
- The batteries we supply are only for setting up and testing your TV, please replace them as soon as necessary.
- Always use good quality batteries.

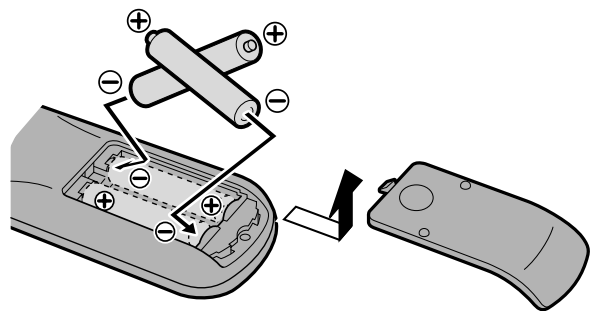

■ Initial Settings

When the TV is first turned on, it enters the initial setting mode, and the JVC logo is displayed. Follow the instructions on the on-screen display to make the initial settings.

1 Press the Main power button on the TV.

The Power lamp lights red (for power on), then green (for TV on) and the JVC logo is displayed.



Note:

- If the power lamp stays red and does not change to green:
Your TV is in the standby mode. Press the  (Standby) button on the remote control to turn your TV on.
- The JVC logo does not appear when your TV has been turned on once.
In this case, use the "LANGUAGE" and "AUTO PROGRAM" functions to make the initial settings. For details, see "INSTALL" on page 25.

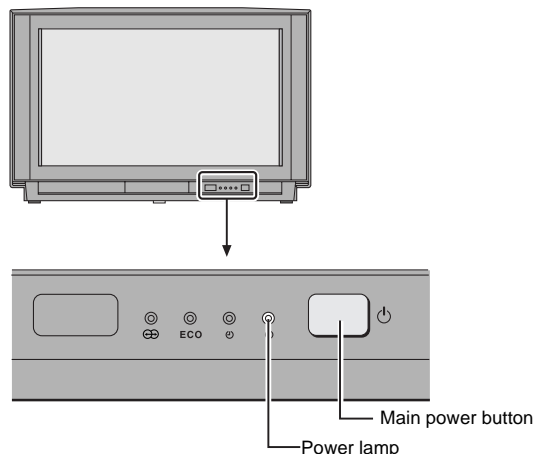

2 Press the button.

The LANGUAGE menu appears.



3 Press the / buttons to choose ENGLISH.

English is set for the on-screen display description.

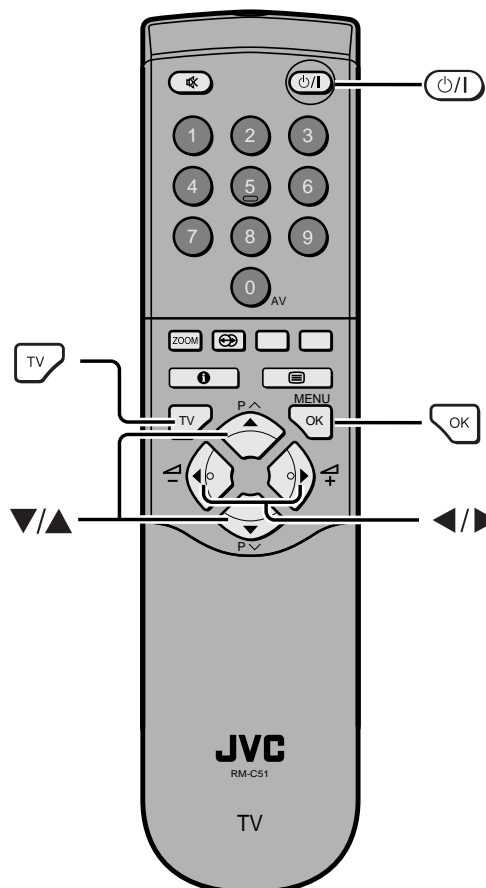

4 Press the button to start the AUTO PROGRAM function.

The AUTO PROGRAM menu appears and received TV channels are automatically registered in the Programme numbers (PR).

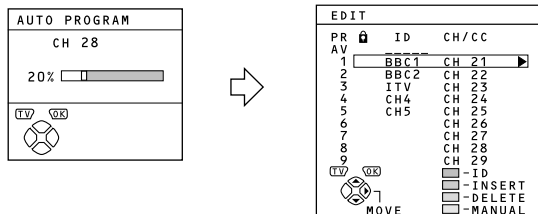

To cancel the AUTO PROGRAM function:

Press the  button.

5 After the TV channels have been registered in the Programme numbers (PR), the EDIT menu appears.

You can proceed to edit the Programme numbers (PR) using the EDIT/MANUAL function. For details, see "EDIT/MANUAL" on page 26.

When not using the EDIT/MANUAL function:

If you do not need to use the EDIT/MANUAL function, go to the next step.

6 Press the button to display the T-V LINK menu.

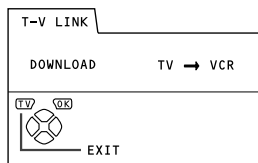

7 Operate the T-V LINK menu according to the type of a VCR connected to the EXT-2 terminal.

When a T-V LINK compatible VCR is not connected:

Press the  button to exit the T-V LINK menu. The T-V LINK menu disappears.

When a T-V LINK compatible VCR is connected:

Follow the operating procedure "Downloading the data to VCR" on page 30 to transmit the Programme number (PR) data.

8 Now, the initial settings are complete, and you can watch the TV.

Note:

- BBC1, BBC2, ITV, CHANNEL4 and CHANNEL 5 are automatically set to the Programme numbers PR 1 to PR 5. SKY 1 is set to the Programme number PR 6, but no TV channel name (ID) be set. If the TV doesn't receive one of these TV channels, that Programme number (PR) will not be set.
- To receive SKY 1 a satellite tuner is needed. You must have the satellite tuner set to SKY 1 before starting the AUTO PROGRAM function.
- If a TV channel you want to view is not set to a Programme number (PR), manually set it using the MANUAL function. For details, see "EDIT/MANUAL" on page 26.
- The TV channel is not registered in Programme number PR 0 (AV). When you want to register a TV channel to PR 0 (AV), manually set it using the MANUAL function. For details, see "EDIT/MANUAL" on page 26.
- In some areas TV reception is possible from more than one transmitter, e.g. different ITV regions. In this case each TV channel may be set twice. If this happens the first set of channels will have the stronger signal. If you want to delete the second set of channels, you will have to do it manually, see page 28.

If you have had any problems setting up your new TV, please call the JVC Helpline at 0181-208-7654

Enjoy your new JVC TV!

T-V LINK FUNCTIONS

When a T-V LINK compatible VCR is connected to the EXT-2 Terminal on the TV, it is easier to set up the VCR and to view videos. T-V LINK uses the following features:

To use T-V LINK functions:

A T-V LINK compatible VCR is necessary.

The VCR must be connected to the EXT-2 terminal on the TV by a fully wired SCART cable.

Note:

- A "T-V LINK compatible VCR" means a JVC VCR with the T-V LINK logo or a VCR with one of the following logos. However, these VCRs may support some or all of the features described below. For details, refer to your VCR instruction manual.

"Q-LINK" (a trademark of Panasonic Corporation)

"Data Logic" (a trademark of Metz Corporation)

"Easy Link" (a trademark of Phillips Corporation)

"Megalogic" (a trademark of Grundig Corporation)

"SMARTLINK" (a trademark of Sony Corporation)

■ Pre-set Download

Download the registered data on the TV channels from the TV to the VCR.

The Preset Download function automatically begins when the initial setting is complete or whenever the AUTO PROGRAM or EDIT/MANUAL operations are performed.

Note:

- This function can be operated via VCR operation.

When "FEATURE NOT AVAILABLE" is displayed:

If "FEATURE NOT AVAILABLE" is displayed, the download was not performed correctly. Before trying to download again, ensure the following:

- The VCR power is turned on.
- The VCR is T-V LINK compatible.
- The VCR is connected to the EXT-2 terminal.
- The SCART cable is fully wired.

■ Direct Rec

"What You See Is What You Record"

You can record to VCR the images that you are currently viewing on TV by a simple operation.

For details, read the manual for your VCR.

Operate via the VCR. "VCR IS RECORDING" is displayed.

In the following conditions, the VCR will stop recording if the TV is turned off, if the TV channel or input is switched, or if the menu is displayed on the TV:

- When recording images from an external device connected to the TV.
- When recording a TV channel after it has been unscrambled on a decoder.
- When recording a TV channel by using the TV's output because that TV channel cannot be properly received on the VCR's tuner.

Note:

- Operation via the TV is not possible.
- Generally, the VCR cannot record a TV channel that cannot be received properly by the VCR's tuner, even though you can view that TV channel on the TV. However, some VCRs can record a TV channel by using the TV's output if that channel can be viewed on the TV, even though the TV channel cannot be received properly by the VCR's tuner. For details, refer to your VCR instruction manual.

■ TV Auto Power On/VCR Image View

When the VCR starts playing, the TV automatically turns on and the images from EXT-2 terminal are displayed on the screen.

When the VCR menu is operated, the TV automatically turns on and the images from EXT-2 terminal are displayed on the screen.

Note:

- This function does not operate if your TV's main power is turned off. Set your TV's main power to on (standby mode).

BASIC OPERATION

■ Turn the Main power on

Press the Main power button on the TV.

The Power lamp lights red and your TV is in the standby mode.

Note:

- If the Power lamp lights green, the TV is already on.

To turn the Main power off:

Press the Main power button again.
The Power lamp goes off.

Note:

- To save energy, turn the main power off if you are not using the TV for a long period of time.

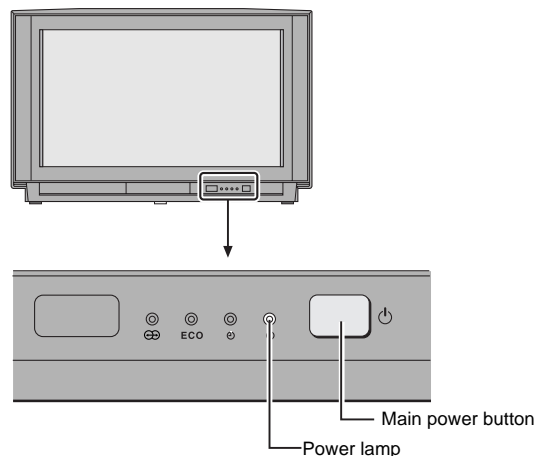

■ Turn the TV on from standby mode

Press the  (Standby) button, the  button, the  buttons or the Number buttons.

The Power lamp lights red to green and your TV will be turned on.

To turn the TV off:

Press the  (standby) button again.
The Power lamp changes from green to red and the TV enters standby mode.

■ Choose a TV channel

Choose a Programme number (PR) in which the desired Programme TV channel has been set.



Use the buttons:

Press the  buttons to choose the desired Programme number (PR).

Use the Number buttons:

Enter the desired Programme number (PR) with the Number buttons.





Example

- PR12 → press  and .
- PR6 → press .

Use the PR LIST:

1 Press the  (Information) button to display the PR LIST.



PR	ID
AV	
1	BBC1
2	BBC2
3	ITV
4	CH4
5	CH5
6	
7	
8	
9	

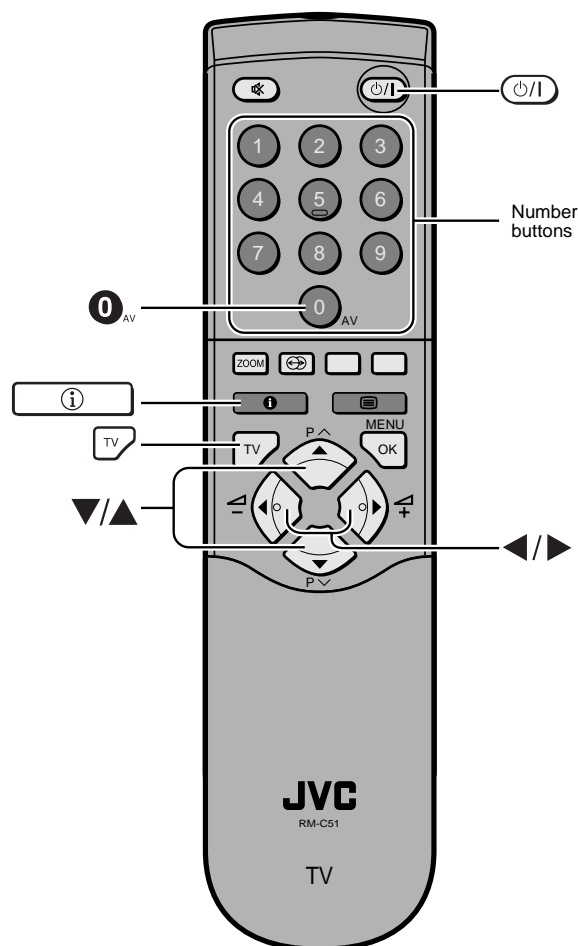

2 Press the ◀/▶ and ▼/▲ buttons to choose a Programme number (PR). Then press the button.

Note:

- For Programme numbers (PR) with the CHILD LOCK function set, the  (CHILD LOCK) mark is displayed next to the Programme number (PR) in the PR LIST
- You cannot use the ▼/▲ buttons to choose a Programme number (PR) with the CHILD LOCK function set.
- Even if you try to choose a Programme number (PR) with the CHILD LOCK function set, the  (CHILD LOCK) mark will appear, and you cannot watch the TV channel. To watch the TV channel, see "CHILD LOCK" on page 23.
- If the picture is tilted, correct it. See "PICTURE TILT" on page 19.

■ Adjust the volume

Press the ◀/▶ buttons to adjust the volume.

The Volume indicator appears and the volume changes as you press the -/+ buttons.

■ Watch images from external devices

Choose an EXT terminal to which the desired external device has been connected.

Use the button:

Press the  button to choose an EXT terminal.

Pressing the  button changes the choice as follows:

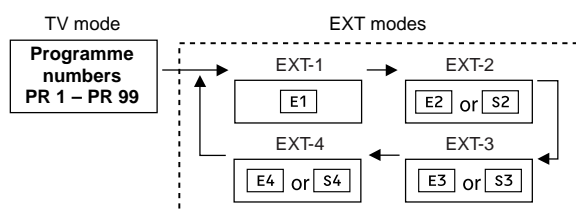

Use the ▼/▲ buttons:

Press the ▼/▲ buttons to choose an EXT terminal

Use the PR LIST:

1 Press the  (Information) button to display the PR LIST.

2 Press the ◀/▶ and ▼/▲ buttons to choose an EXT terminal. Then press the  button.

Note:

- The EXT terminals are registered after the Programme number PR 99.
- You can choose a video input signal from the S-VIDEO signal (Y/C signal) and regular video signal (composite signal). For details, see "S-VIDEO input" on page 21.
- If you do not have a clear picture or no colour appears, change the colour system manually. See "COLOUR SYSTEM" on page 18.
- When choosing an EXT terminal with no input signal, the EXT terminal number becomes fixed on the screen.
- This TV set has a function which can automatically change over the input according to a special signal output from an external device. (The EXT-4 terminal does not support it.)

To return to a TV channel:

Press the  button, the ▼/▲ buttons or the Number buttons.

To use the Programme number PR 0 (AV):

When the TV and VCR are connected only by the Aerial cable, choosing the Programme number PR 0 (AV) allows you to view images from the VCR. Set the VCR RF channel to the Programme number PR 0 (AV) manually. For details, see "EDIT/MANUAL" on page 26.

Pressing the  button changes the choice as follows:

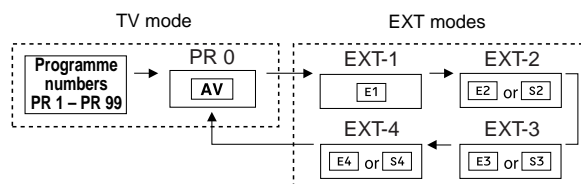

Note:

- The VCR RF channel is sent as the RF signal from the VCR.
- Also refer to your VCR instruction manual.

■ Operating with the buttons on the TV

1 Press the P ∇/\wedge buttons to turn the TV on from standby mode.

2 Press the P ∇/\wedge buttons to choose a Programme number (PR) or an EXT terminal.

3 Press the \triangleleft (Volume) button and the $-/+$ buttons to adjust the volume.

1 Press the \triangleleft (Volume) button.

The volume level indicator appears.

2 Press the $-/+$ buttons while the volume level indicator is displayed.

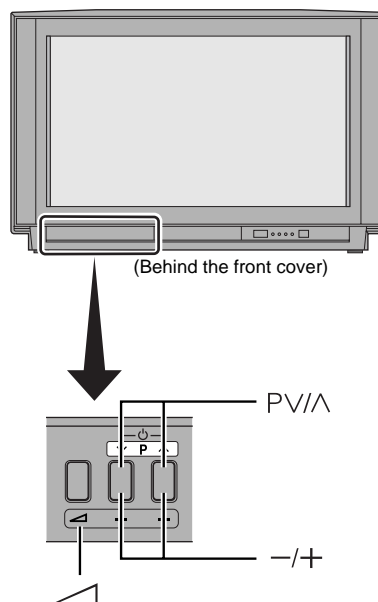

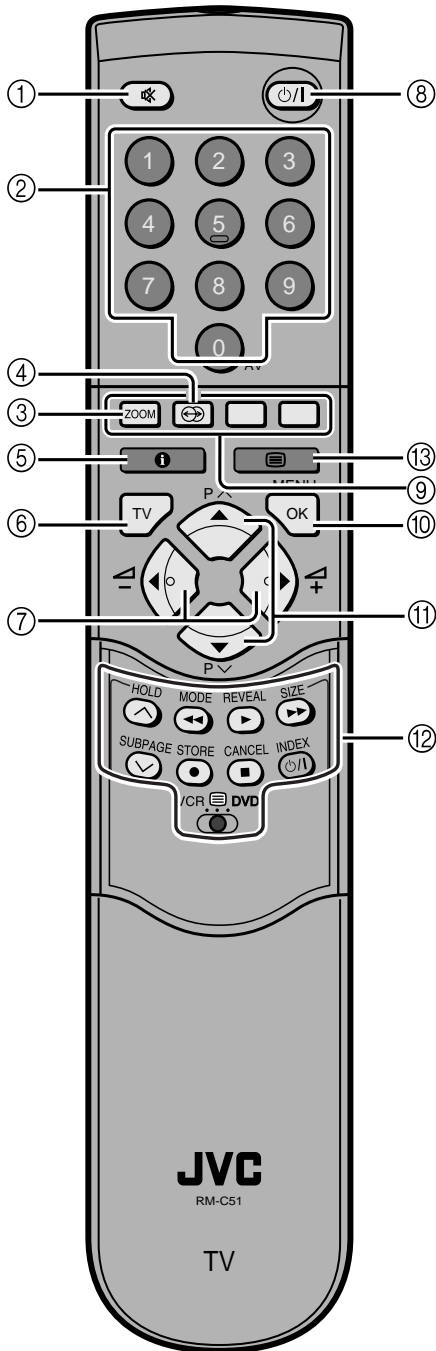

REMOTE CONTROL BUTTONS AND FUNCTIONS



① Muting Button

You can turn the volume off instantly.

Press the  (Muting) button to turn off the Volume. Pressing the  (Muting) button again resumes the previous Volume level.

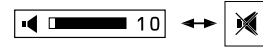

② Number Buttons

You can choose a Programme number (PR) by entering the Programme number.

Example:

- PR12 → press ① and ②.
- PR6 → press ⑥.

You can also press the ⑦ button repeatedly to choose an EXT terminal.

③ ZOOM Button

You can change the screen size according to the picture aspect ratio. Choose the optimum one from in the following ZOOM modes.

AUTO:

For any picture format except Normal Picture (4:3 Aspect Ratio), the picture will be automatically displayed in the optimum screen size.

For Normal Picture (4:3 Aspect Ratio), the picture displayed in accordance with the ZOOM mode set on the 4:3 AUTO ASPECT menu. For details, see "4:3 AUTO ASPECT" on page 18.

Note:

- AUTO may not function properly with poor signal quality. In this case, choose an optimum ZOOM mode manually.
- This TV supports WSS (wide-screen signals). When broadcasts with WSS are received with the ZOOM mode set at AUTO, the most suitable ZOOM mode is automatically chosen according to the WSS received.
- When the special signal output from an external device is received with the ZOOM mode set to AUTO, the ZOOM mode automatically changes to 16:9 ZOOM. (The EXT-4 terminal does not support it.)

REGULAR:

Use to view a normal picture (4:3 aspect ratio) as its original size is.



PANORAMIC:

This mode stretches the left and right sides of a normal picture (4:3 Aspect Ratio) to fill the screen, without making the picture appear unnatural.

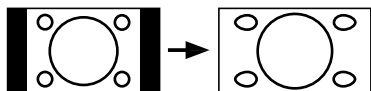

Note:

- The top and bottom of the picture are slightly cut off.

14:9 ZOOM:

This mode zooms up the Wide Picture (14:9 Aspect Ratio) to the upper and lower limits of the screen.

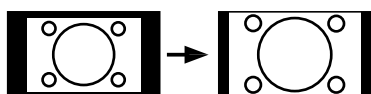

16:9 ZOOM:

This mode zooms up the Wide Picture (16:9 Aspect Ratio) to the full screen.



16:9 ZOOM SUBTITLE:

This mode zooms up the Wide Picture (16:9 Aspect Ratio) with subtitles to the full screen.

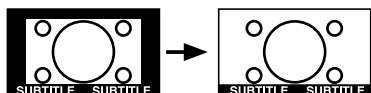

FULL:

This mode uniformly stretches the left and right sides of a normal picture (4:3 aspect ratio) to fill the wide TV screen.

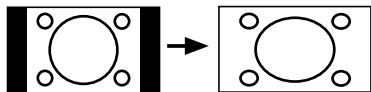

Note:

- Use for pictures with a 16:9 aspect ratio that have been squeezed into a normal picture (4:3 aspect ratio), you can restore their original dimensions.

Choose the ZOOM mode

- 1 Press the **ZOOM** button to display the ZOOM menu.

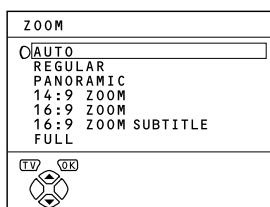

- 2 Press the **▼/▲** buttons to choose a ZOOM mode. Then press the **OK** button.

The picture expands and the chosen ZOOM mode is displayed in about 5 seconds.

Note:

- You can pre-set a ZOOM mode for the normal picture. See "4:3 AUTO ASPECT" on page 18.

Adjusting the visible area of the picture

If subtitles or the top (or bottom) of the picture are cut off, adjust the visible area of the picture manually.

- 1 Press the **ZOOM** button.

The ZOOM menu appears.

- 2 Press the **OK** button to display the ZOOM mode indication.

Indicator is displayed.

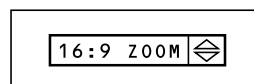

- 3 While it is displayed, press the **▼/▲** buttons to adjust the visible area vertically.

Note:

- You cannot adjust the visible area in REGULAR or FULL mode.

4 HYPER SOUND Button

You can enjoy sounds with a wider ambience.

Press the **HS** (HYPER SOUND) button to turn the HYPER SOUND function on or off.

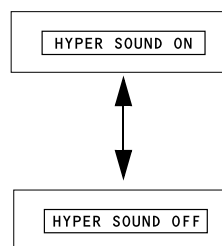

Note:

- The HYPER SOUND function does not work properly with mono sound.
- The HYPER SOUND lamp lights while the HYPER SOUND function is in use.
- The HYPER SOUND function can be also turned on or off by using the SOUND SETTING menu. For details, see "HYPER SOUND" on page 20.

⑤ Information Button

You can display the PR LIST or the Current Time on the screen.

Press the  (Information) button.

Pressing the  (Information) button changes the display as follows:

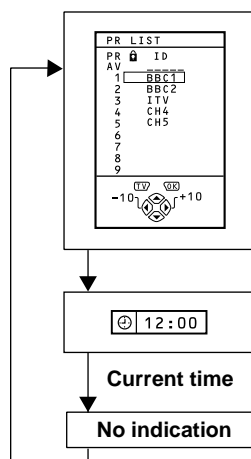

Note:

- You can choose Programme numbers (PR) or EXT terminals with the PR LIST. For details, see "Use the PR LIST:" on page 8.
- This TV uses teletext data to set the current time. If the TV has not received a TV channel that has teletext programmes since it was turned on, the time display is blank. To view the current time, choose a TV channel that has teletext programmes. The time will still be displayed as long as you do not turn off the TV, even if you choose other TV channels.
- When watching videos, an incorrect current time is sometimes displayed.
- The  (Information) button is also used to operate menus. For details, see "MENU OPERATION" on page 16.

⑥ TV Button

You can return to a TV channel instantly.

Press the  button.

The TV returns to the TV mode and a TV channel appears.

Note:

- The  button is also used to operate menus. For details, see "MENU OPERATION" on page 16.

⑦ ◀/▶ Buttons

You can adjust the volume.

Press the  buttons to adjust the sound.

Note:

- The  buttons are also used to operate menus. For details, see "MENU OPERATION" on page 16.

⑧ Standby Button

Press the  (Standby) button to turn the TV on or off.

When the TV is turned on, the power lamp changes from red to green.

⑨ Colour Buttons

The colour buttons are used for the teletext operations or the menu operations. For details, see "⑬ Teletext Control Buttons and VCR/DVD Switch" on page 14 or "MENU OPERATION" on page 16.

⑩ OK Button

The  button is used to operate menus. For details, see "MENU OPERATION" on page 16.

⑪ ▼/▲ Buttons

You can choose a Programme number (PR) or an EXT terminal.

Press the  buttons to choose an Programme number (PR) or an EXT terminal.

The  buttons are also used to operate menus. For details, see "MENU OPERATION" on page 16.

⑫ VCR/DVD Control Buttons and VCR/DVD Switch

These buttons can be used to operate a JVC brand VCR or DVD player. Pressing the button having the same appearance as the original remote control button of a device makes the function work in the same way as the original remote control.

1 Set the VCR/DVD Switch to the VCR or DVD position.

VCR:

When you are operating the VCR, set the switch to the VCR position.

DVD:



When you are operating the DVD player, set the switch to the DVD position.

(Text):

When you are viewing Teletext programmes, set the switch to the  (Text) position.

2 Press the VCR/DVD Control Button to control your VCR or DVD player.

Note:

- If your device is not made by JVC, these buttons cannot be used.
- Even if your device is made by JVC, some of these buttons or any one of the buttons may not work, depending on the device.
- You can use the  buttons to choose a TV channel the VCR will receive or choose the chapter the DVD player plays back.
- Some DVD player models use the  buttons for both operation of Fast forward/backward functions and choosing the chapter. In this case, the  the buttons do not work.

■ 13 Teletext Control Buttons and VCR/☰/DVD Switch

Basic operation

You can view two types of teletext broadcasts on the TV: FLOF (Fastext) and WST.

- 1 Choose a TV channel with a teletext broadcast.
- 2 Set the VCR/☰/DVD switch to the ☰ (Text) position.



- 3 Press (Text) button to display the teletext.

Pressing (Text) button changes the mode as follows:

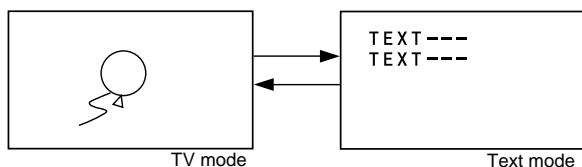

- 4 Choose a teletext page by pressing the ▼/▲ buttons, Number buttons or Colour buttons.

To return to the TV mode:

Press the button or (Text) button.

Note:

- If you have trouble receiving teletext broadcasts, consult your local dealer or the teletext station,
- In the Text mode, the ZOOM mode is fixed to the FULL mode.
- No menu operations are possible when viewing a teletext programme.

Using the List Mode

You can store the numbers of your favourite teletext pages in memory and call them up quickly using the colour buttons.

To store the page numbers:

- 1 Press button to engage the List mode.
The stored page numbers are displayed at the bottom of the screen.
- 2 Press a Colour button to choose a position. Then press the Number buttons to enter the page number.

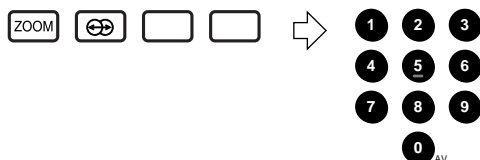

- 3 Press and hold down button.

The four page numbers blink white to indicate that they are stored in memory.

To call up a stored page:

- 1 Press the button to engage the List mode.
- 2 Press a colour button to which a page has been assigned.



To exit the List mode:

Press the button again.

Hold

You can hold a teletext page on the screen for as long as you want, even while several other teletext pages are being received.

Press the button.

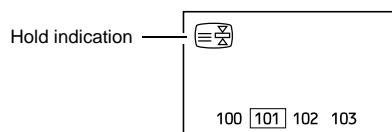

To cancel the Hold function:

Press button again.

Sub-page

Some teletext pages include sub-pages that are automatically displayed.

You can hold any sub-page, or view it at any time.

- 1 Press the button to operate the Sub-page function.
- 2 Press the Number buttons to enter a sub-page number.

Example:

- 3rd sub-page → press **0**, **0**, **0** and **3**.

To cancel the Sub-page function:

Press the button again.

Note:

- You can also choose a sub-page by pressing the red or green button.

Reveal

Some teletext pages include hidden text (such as answers to a quiz).

You can display the hidden text.

Each time you press the ^{REVEAL}  button, text is hidden or revealed.

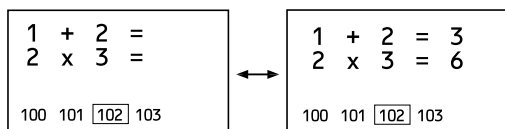

Size

You can double the height of the teletext display.

Press the ^{SIZE}  button.

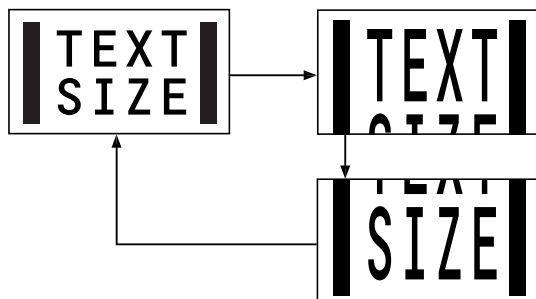

Index

You can return to the index page instantly.

Press the ^{INDEX}  button.

FLOF (Fastext)/WST:

Returns to page 100 or a previously specified page.

List mode:

Returns to the page number displayed in the lower left area of the screen.

Cancel

You can search for a teletext page while watching TV.

- 1 Press the Number button to enter a page number, or press a Colour button.

The TV searches for a teletext page.

- 2 Press the ^{CANCEL}  button.

The TV programme appears. When the TV finds the teletext page, its page number appears in the upper left of the screen.

- 3 Press the ^{CANCEL}  button to return to a teletext page when the page number is on the screen.

Note:

- The TV mode cannot be resumed even by pressing the ^{CANCEL}  button. A TV programme is temporarily displayed instead of the teletext programme.

MENU OPERATION

www.DataSheet4U.com

This TV has a number of functions you can operate using menus. To fully utilize all your TV's functions, you need to understand the basic menu operating techniques fully.

1 Press the button to display the MENU (main menu).

The MENU (main menu) appears. In it, the titles of the menus are displayed.

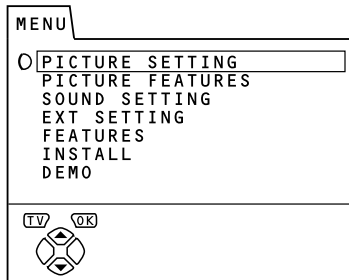

2 Press the / buttons to choose a menu title, and press the button.

The menu appears.

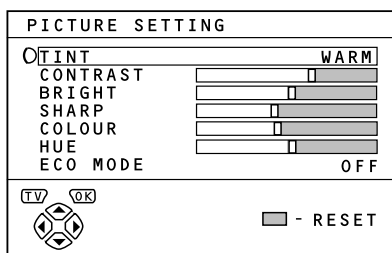

3 Operate the menus according to the operation description of each function.

Note:

- For details, refer to the operation descriptions of each function described for each menu which follows this "MENU OPERATION".
- The display appearing at the bottom of a menu indicates a button on the remote controller you can use when you operate a chosen function.

4 Press button to complete the setting.

The menu disappears.

To return to the previous menu:

Press  (information) button.

To exit a menu instantly:

Press the  button.

PICTURE SETTING

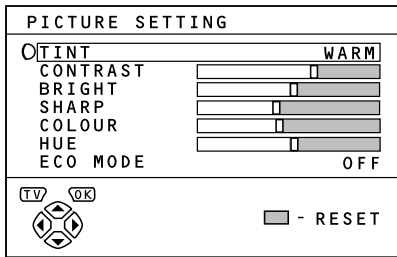

To display the PICTURE SETTING menu:

- 1 Press the button to display MENU (main menu).
- 2 Press the button to choose PICTURE SETTING, and press the button.

■ TINT

You can select one of three TINT modes (three kinds of picture settings) to adjust the picture settings automatically.

- 1 Press the buttons to choose TINT.
- 2 Press buttons to choose a mode.

COOL:

A cool white colour base with a boost in the colour and contrast levels that creates a more vivid picture.

WARM:

A warm orange/red colour base that creates the appropriate colour and contrast levels for watching films.

NORMAL:

A normal white colour base with normal colour and contrast levels.

- 3 Press the button to complete the setting.

The menu disappears.

■ Picture Adjustment

You can change the picture settings of each TINT mode as you like.

The picture settings changed are stored in the TINT mode.

- 1 Press the buttons to choose an item.
- 2 Press the buttons to change the setting.

◀	Item	▶
Lower	CONTRAST (picture contrast)	Higher
Darker	BRIGHT (picture brightness)	Brighter
Softer	SHARP (picture sharpness)	Sharper
Lighter	COLOUR (picture colour)	Deeper
Reddish	HUE (picture hue)	Greenish

Note:

- You can change the HUE setting (picture hue) only when the colour system is NTSC 3.58 or NTSC 4.43.

To return to the default settings in each TINT mode:

Press the blue button.

Returns the picture settings in the currently chosen TINT mode to the default settings, and stores them in the TINT mode again.

- 3 Press the button to complete the settings.

The menu disappears.

■ ECO MODE

When you set the ECO MODE function to ON, the screen contrast is automatically adjusted to a setting suitable for the brightness of your room. This reduces eye strain for you and the power consumption of the TV.

- 1 Press buttons to choose ECO MODE.
- 2 Press buttons to choose ON.

To cancel the ECO MODE function:

Press buttons to choose OFF.

- 3 Press the button to complete the setting.

The menu disappears.

Note:

- If you set the ECO MODE function to ON, the ECO lamp lights.

PICTURE FEATURES

www.DataSheet4U.com

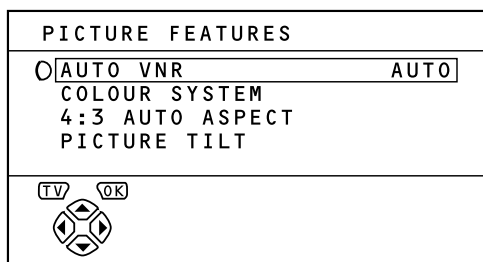

To display the PICTURE FEATURES menu:

- 1 Press the button to display MENU (main menu).
- 2 Press the button to choose PICTURE FEATURES, and press the button.

■ AUTO VNR

The AUTO VNR function optimally reduces noise of the TV automatically according to the noise of the current picture. The function also adjusts the optimum Sharpness (SHARP).

- 1 Press the buttons to choose AUTO VNR.
- 2 Press the buttons to choose AUTO.

MIN:

The AUTO VNR function is cancelled. When you set the mode to AUTO but feel that the sharpness of the original picture has not been reproduced fully, change the mode to MIN. However, a noise remaining in the original picture may be emphasized.

MAX:

This mode always maximizes the noise reduction effect irrespective of state of the picture. When you set the mode to AUTO but feel that the noise is remarkable, change the mode to MAX. However, this may reduce the sharpness of the picture.

- 3 Press the button to complete the setting.

The menu disappears.

■ COLOUR SYSTEM

The colour system is chosen automatically. However, if the picture is not clear or no colour appears, choose the colour system manually.

- 1 Press the buttons to choose COLOUR SYSTEM. Then press the button.

The Sub-menu of the COLOUR SYSTEM function appears.

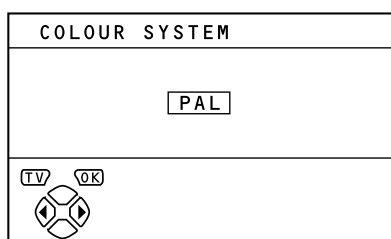

- 2 Press the buttons to choose the appropriate colour system.

PAL:

PAL system

NTSC 3.58:

NTSC 3.58 MHz system

NTSC 4.43

NTSC 4.43 MHz system

AUTO:

This function detects a colour system from the input signal. Only when you are viewing a picture from Programme number PR 0 (AV), or EXT terminal, you can choose using the AUTO function.

- 3 Press the button to complete the setting.

The menu disappears.

Note:

- The AUTO function may not function properly if you have poor signal quality. If the picture is abnormal in the AUTO function, choose another colour system manually.
- When in the Programme numbers PR 0 (AV) to PR 99, you cannot choose NTSC 3.58 or NTSC 4.43.

■ 4:3 AUTO ASPECT

You can choose one of three ZOOM modes, REGULAR, PANORAMIC or 14:9 ZOOM, as the ZOOM mode for the normal picture (4:3 aspect ratio).

- 1 Press the buttons to choose 4:3 AUTO ASPECT. Then press the button.

The Sub-menu of the 4:3 AUTO ASPECT function appears.

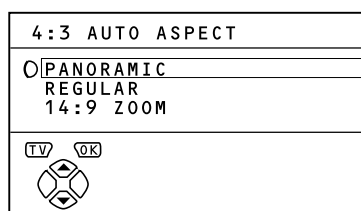

- 2 Press the buttons to choose a ZOOM mode.

- 3 Press the button to complete the settings.

The menu disappears.

■ PICTURE TILT

There are cases where the Earth's magnetic force may make the picture tilt. If this happens, you can correct the picture tilt.

- 1 Press the ▼/▲ buttons to choose PICTURE TILT. Then press the  button.**

The Sub-menu of the PICTURE TILT function appears.

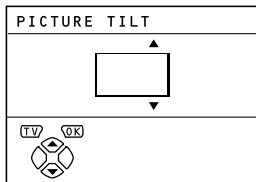

- 2 Press the ▼/▲ buttons until the picture becomes level.**
- 3 Press the  button to complete the setting.**

The menu disappears.

SOUND SETTING

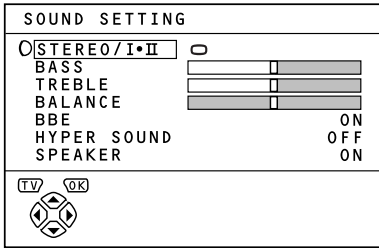

To display the **SOUND SETTING** menu:

- 1 Press the button to display **MENU** (main menu).
- 2 Press the button to choose **SOUND SETTING**. Then press the button.

■ STEREO / I•II

When you are viewing a bilingual broadcast programme, you can choose the sound from Bilingual I (Sub I) or Bilingual II (Sub II). When the stereo broadcasting is received poorly, you can change from stereo to mono sound so that you can hear the broadcast more clearly and easily.

- 1 Press buttons to choose **STEREO / I•II**.
- 2 Press buttons to choose a sound mode.

- :Stereo sound
- :mono sound
- I** :Bilingual I (sub I)
- II** :Bilingual (sub II)

- 3 Press the button to complete the setting.

The menu disappears.

Note:

- The sound mode you can choose differs depending on the TV programme.
- This function does not work in the EXT modes. And this function does not appear in the **SOUND SETTING** menu.

■ Sound Adjustment

You can adjust the sound to your liking.

- 1 Press the buttons to choose an item.
- 2 Press the buttons to adjust it.

◀	Item	▶
Weaker	BASS	Stronger
Weaker	TREBLE	Stronger
Left	BALANCE	Right

- 3 Press the button to complete the setting.

The menu disappears.

■ SPEAKER

You can turn off the sound from the TV speakers; but you should only do this if an audio system is connected to the TV as a substitute for the TV speakers. When you are using this function, see "Setting the **SPEAKER** function" on page 31.

When a sound is not issued from the TV speaker:

If the **SPEAKER** function is set to OFF, the TV speaker does not issue sound. Press the buttons to choose the **SPEAKER**. Then press buttons to choose ON.

■ BBE

You can use the BBE function to enjoy easy-to-listen sound that is faithful to the original sound recorded.

- 1 Press buttons to choose **BBE**.
- 2 Press buttons to choose **ON**.

To cancel the BBE function:

Press buttons to choose OFF.

- 3 Press the button to complete the setting.

The menu disappears.

- Licensed by BBE Sound Inc. BBE is a registered trademark of BBE Sound, Inc.

■ HYPER SOUND

You can enjoy sounds with a wider ambience.

- 1 Press buttons to choose **HYPER SOUND**.
- 2 Press buttons to choose **ON**.

To cancel the HYPER SOUND function:

Press the buttons to choose OFF.

- 3 Press the button to complete the setting.

The menu disappears

Note:

- The **HYPER SOUND** function does not work properly with mono sound.
- The **HYPER SOUND** lamp lights while the **HYPER SOUND** function is in use.
- You can turn on or off the **HYPER SOUND** function with a single press. For details, see "④ **HYPER SOUND** Button" on page 12.

EXT SETTING

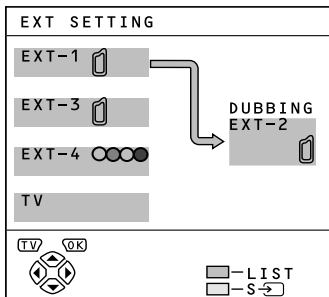

To display EXT SETTING menu:

- 1 Press the **OK** button to display MENU (main menu).
- 2 Press the **▼/▲** button to choose EXT SETTING. Then press the **OK** button.

■ S-V (S-VIDEO input)

When connecting a device (such as S-VHS VCR) which enables an S-VIDEO signal (Y/C signal) to be output, you can enjoy high-quality picture of the S-VIDEO signal (Y/C signal).

Preparation:

- At first, read the Device Instruction Manual and "ADDITIONAL PREPARATION" on page 32 to connect the device to the TV properly. Second, follow the Device Instruction Manual to set the device so that a S-VIDEO signal (Y/C signal) can be output to the TV.
- Do not set S-V (S-VIDEO input) to the EXT terminal connected to a device which cannot output a S-VIDEO (Y/C signal). If it is set wrongly, a picture cannot appear.

- 1 Press the **▼/▲** buttons or **◀/▶** buttons to choose an EXT terminal.

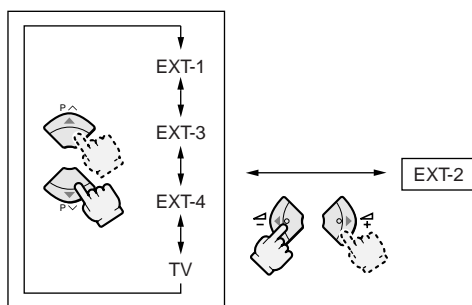

- 2 Press the yellow button and set the **S-V** (S-VIDEO input).

A **S-V** (S-VIDEO input) mark is displayed. You can view an S-VIDEO signal (Y/C signal) instead of the regular video signal (composite signal).

To cancel the S-V (S-VIDEO input) setting:

Press the yellow button and turn off **S-V** (S-VIDEO input) mark.
The regular video signal (composite signal) pictures are resumed.

- 3 Press the **OK** button to complete the setting.

The menu disappears.

Note:

- The EXT-1 terminal does not support S-VIDEO signal (Y/C signal) and you cannot set **S-V** (S-VIDEO input) in the EXT-1 terminal.
- Setting **S-V** (S-VIDEO input) changes the head character from "E" to "S". For example, "E2" is changed to "S2".
- Even an device which enables the S-VIDEO signal (Y/C signal) to be output may output a regular video signal (composite signal) depending on the device setting. If a picture cannot appear because **S-V** (S-VIDEO input) setting has been made, read the device Instruction Manual carefully again to check for the device settings.

■ LIST

You can have a name corresponding to the devices connected for each EXT terminal. Giving a name to an EXT terminal makes the EXT terminal number appear on the screen, together with the name.

- 1 Press the **▼/▲** buttons or **◀/▶** buttons to choose an EXT terminal.

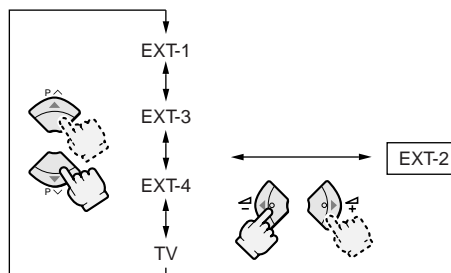

- 2 Press the blue button to display the name list (LIST).

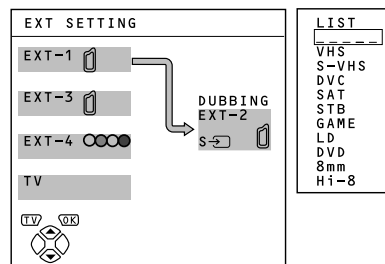

**3 Press the ▼/▲ buttons to choose a name.
Then press the  button.**

The LIST disappears and the name is assigned to the EXT terminal.

To erase a name assigned to the EXT terminal:

Choose a blank space.

4 Press the  button to complete the setting.

The menu disappears.

Note:

- You cannot assign an EXT terminal name not found in the name list (LIST).

■ DUBBING

You can choose a signal source to be output from an EXT-2 terminal.

You can choose any one of the output signal of the device connected to the EXT terminal and the picture and sound from a TV channel you are currently viewing to output it to the EXT-2 terminal.

1 Press the ◀/▶ buttons to choose the EXT-2 terminal.

2 Press the ▼/▲ buttons to choose an EXT terminal or TV.

The arrow in the menu represents a signal flow. The left side of the arrow denotes a signal source output from the EXT-2 terminal.

EXT-1/EXT-3/EXT-4:

The output signal of the device connected to an EXT terminal passes through the TV and is output from the EXT-2 terminal.

TV:

The picture and sound of the TV channel you are currently viewing are output from the EXT-2 terminal.

3 Press the  button to complete the setting.

The menu disappears.

Note:

- During dubbing, you cannot turn off the TV. Turning off the TV also turns off the output from the EXT-2 terminal.
- When you choose an EXT terminal as an output, you can view a TV programme or a picture from the other EXT terminal while dubbing the picture from a device connected to the EXT terminal onto a VCR connected to the EXT-2 terminal.
- The RGB signals from the TV games cannot be output. Teletext programmes cannot be output.



FEATURES

www.DataSheet4U.com

FEATURES	
<input type="radio"/> SLEEP TIMER	
<input type="radio"/> BLUE BACK	ON
<input type="radio"/> CHILD LOCK	
<input type="radio"/> DECODER (EXT-2)	OFF



To display the FEATURES menu:

- 1 Press the  button to display MENU (main menu).
- 2 Press the  button to choose FEATURES. Then press the  button.

■ SLEEP TIMER

You can set the TV to automatically turn off after a specified period of time.

- 1 Press the  buttons to choose SLEEP TIMER. Then press the  button.

A Sub-menu of the SLEEP TIMER function appears.

SLEEP TIMER	
<input type="radio"/> OFF	0  120



- 2 Press the  buttons to set the period of time.

You can set the period of time a maximum of 120 minutes (2 hours) in 10 minute increments.

To cancel the SLEEP TIMER function:

Press the  button to set a period of time to "OFF."

- 3 Press the  button to complete the settings.

The menu disappears.

Note:

- The SLEEP TIMER lamp lights while the SLEEP TIMER function is operating.
- One minute before the SLEEP TIMER function turns off the TV, "GOOD NIGHT!" appears.
- The SLEEP TIMER function cannot be used to turn off the TV's main power.
- When the SLEEP TIMER function is on, you can display the Sub-menu of the SLEEP TIMER function again to confirm and/or change the remaining period of time of the SLEEP TIMER function. Press the  button to exit the menu after confirming and / or changing the remaining time.

■ BLUE BACK

You can set the TV to automatically change to a blue screen and mute the sound if the signal is weak or absent, or when there is no input from an external device.

- 1 Press the  buttons to choose BLUE BACK.

- 2 Press the  buttons to choose ON.

To cancel the BLUE BACK function:

Press the  buttons to choose OFF.

- 3 Press the  button to complete the setting.

The menu disappears.

■ CHILD LOCK

When there is a TV channel you wish your children not to watch, you can use the CHILD LOCK function to lock out the TV channel. Even when a child chooses a Programme number (PR) in which a locked TV channel has been registered, the screen will change to blue and displays  (CHILD LOCK) so the TV channel cannot be viewed. Unless you enter a pre-set ID number by a special operation, the lock cannot be released and the child cannot view the TV channel programs.

To set the CHILD LOCK function

- 1 Press the  buttons to choose CHILD LOCK. Then press the  button.

"SET ID NO." (ID number setting screen) appears.

SET ID NO.	
	0000



- 2 Set the ID number to your liking.

- 1 Press the  buttons to choose a number.
- 2 Press the  buttons to move the cursor.

- 3 Press the  button.

The Sub-menu of CHILD LOCK appears.

CHILD LOCK		
PR	ID	CH / CC
1	BBC 1	CH 21
2	BBC 2	CH 22
3	ITV	CH 23
4	CH 4	CH 24
5	CH 5	CH 25
6		CH 26
7		CH 27
8		CH 28
9		CH 29



- 4 Press the  buttons to choose a TV channel.

Every time you press the  buttons, the Programme number (PR) changes, and the picture of the TV channel registered in the Programme number (PR) is displayed on the screen.

www.DataSheet4U.com

5 Press the blue button and set the CHILD LOCK function.

🔒 (CHILD LOCK) appears and the TV channel is locked.

To reset the CHILD LOCK function:

Press the blue button again.

🔒 (CHILD LOCK) disappears.

6 Press the button to complete the setting.

The menu disappears.

Note:

- To disable easy resetting of the CHILD LOCK function, the menu disappears by choosing the CHILD LOCK function and pressing the  button as in the ordinary menu operation.

■ DECODER (EXT-2)

Only when connecting a Decoder with a T-V LINK compatible VCR connected to the EXT-2 terminal, you can use this function. To operate this function, see "Using the DECODER (EXT-2) function" on page 30.

Caution:

- If you have not connected a Decoder with a T-V LINK compatible VCR connected to the EXT-2 terminal, setting this function to "ON" by mistake causes the picture/sound of a TV channel you are currently viewing not to be issued.

To view a locked TV channel

1 Choose a Programme number (PR) in which a TV channel locked with the Number buttons or PR LIST.

The screen changes to blue and the 🔒 (CHILD LOCK) appears. You cannot view the TV channel.

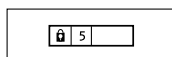

2 Press the (Information) button to display "ID NO." (ID No. input screen).

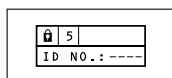

3 Press the Number buttons to enter the ID number.

The lock is temporarily released so you can view the TV channel.

If you have forgotten the ID number:

Perform step 1 of "To set the CHILD LOCK function". After confirming the ID number, press the  button to exit the menu.

Note:

- Even if you reset the lock temporarily, it does not mean that the CHILD LOCK function set for the TV channel is cancelled. The next time anyone attempts to view the TV channel, it will be locked again.
- When you would like to cancel the CHILD LOCK function, you must perform the operation "To set the CHILD LOCK function" again.
- To disable easy choosing of a Programme number (PR) in which a locked TV channel has been registered, the Programme number (PR) has been set that it cannot be chosen by the ▼/▲ buttons or the operation buttons at the TV.
- To disable easy resetting of the lock, "ID NO." (ID No. input screen) is set so that it cannot appear unless you press the  (Information) button.

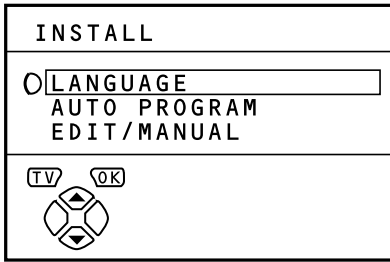

To display the **INSTALL** menu:

- 1 Press the **OK** button to display **MENU** (main menu).
- 2 Press the **▼/▲** button to choose the **INSTALL** menu. Then press the **OK** button.

■ LANGUAGE

You can choose the language you want to use for the on-screen display from the language list in a menu.

- 1 Press the **▼/▲** buttons to choose **LANGUAGE**. Then press the **OK** button.

A sub-menu of the LANGUAGE function appears.

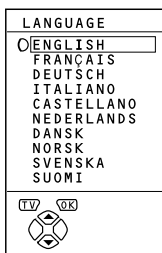

- 2 Press the **▼/▲** buttons to choose a language.
- 3 Press the **OK** button to complete the setting.

The menu disappears.

■ AUTO PROGRAM

You can automatically register the TV channels which can be received well at your residence in the TV's Programme numbers (PR) by performing the following.

- 1 Press the **▼/▲** buttons to choose **AUTO PROGRAM**.
- 2 Press the **OK** button to start the **AUTO PROGRAM** function.

The **AUTO PROGRAM** menu appears and received TV channels are automatically registered in the Programme numbers (PR).

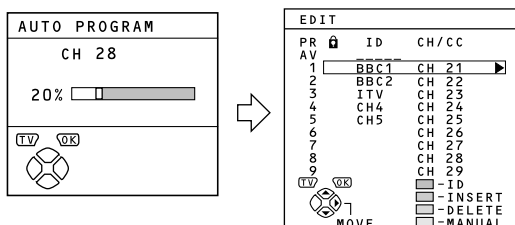

To cancel the **AUTO PROGRAM** function:

Press the **TV** button.

- 3 After the TV channels have been registered in the Programme numbers (PR), the **EDIT** menu appears.

You can proceed to edit the Programme numbers (PR) using the **EDIT/MANUAL** function. For details, see "EDIT/MANUAL" on page 26.

When not using the EDIT/MANUAL function:

If you do not need to use the **EDIT/MANUAL** function, go to the next step.

- 4 Press the **OK** button to display the **T-V LINK** menu.

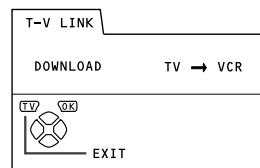

- 5 Operate the **T-V LINK** menu according to the type of **VCR** connected to the **EXT-2** terminal.

When a T-V LINK compatible VCR is not connected:

Press the **TV** button to exit the **T-V LINK** menu.

The **T-V LINK** menu disappears, and all the settings are completed.

When a T-V LINK compatible VCR is connected:

Follow the operating procedure "Downloading the data to VCR" on page 30 to transmit the Programme number (PR) data to the VCR.

Note:

- To receive **SKY 1** a satellite tuner is needed. You must have the satellite tuner set to **SKY 1** before starting the **AUTO PROGRAM** function.
- If a TV channel you want to view is not set to a Programme number (PR), manually set it using the **MANUAL** function. For details, see "EDIT/MANUAL" on page 26.
- The TV channel is not registered in Programme number PR 0 (AV). When you want to register a TV channel to PR 0 (AV) manually set it using the **MANUAL** function. For details, see "EDIT/MANUAL" on page 26.
- In some areas TV reception is possible from more than one transmitter, e.g. different **ITV** regions. In this case each TV channel may be set twice. If this happens the first set of channels will have the stronger signal. If you want to delete the second set of channels, you will have to do it manually, see page 28.

■ EDIT/MANUAL

The EDIT/MANUAL functions are divided into two types: editing of the current Programme numbers (PR) (EDIT functions) and manual registration of a TV channel you want to view to the Programme number (PR) (MANUAL function). The details about these functions are as follows:

MOVE:

This function changes a Programme number (PR) of a TV channel.

ID:

This function registers a Channel name (ID) to a TV channel.

INSERT:

This function adds a new TV channel in the current Programme numbers (PR) list by using the CH number.

DELETE:

This function deletes a unnecessary TV channel.

MANUAL:

This function manually registers a new TV channel in a Programme number (PR).

Caution:

- Using the MOVE, DELETE or INSERT function rewrites the current Programme numbers (PR) list. Resultingly, the Programme number (PR) of some of the TV channels will change.
- Using the MANUAL function for a TV channel for which the CHILD LOCK function has been set cancels the CHILD LOCK function for the TV channel.
- Using the MANUAL function for a TV channel for which the DECODER (EXT-2) function has been set to ON returns the setting of the DECODER (EXT-2) function for the TV channel to OFF.
- When a TV channel has already been registered in PR 99, using the INSERT function deletes the TV channel.

Note:

- For Programme number PR 0, "AV" appears in the Programme numbers (PR) list.
- An EXT terminal number does not appear in the Programme numbers (PR) list.
- The CH number is a number unique to the TV and corresponding to the Channel number of a TV channel. For the relationship of a Channel number and a CH number, see "CH NUMBER" on page 28.
- You cannot use the INSERT function if you do not know a Channel number of a TV channel. Use the MANUAL function to register a TV channel in the Programme number (PR).

- 1 Press the **▼/▲** buttons to choose EDIT/MANUAL. Then press the **OK** button.

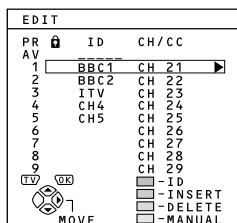

- 2 Follow the operation description of a function you want to use and operate the function.

- 3 Press the **OK** button to complete the settings.

The T-V LINK menu appears.

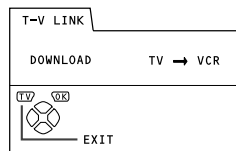

- 4 Operate the T-V LINK menu according to the type of VCR connected to the EXT-2 terminal.

When a T-V LINK compatible VCR is not connected:

Press the **TV** button to exit the T-V LINK menu.

The T-V LINK menu disappears and all the settings are completed.

When a T-V LINK compatible VCR is connected:

Follow the operating procedure "Downloading the data to VCR" on page 30 to transmit the Programme number (PR) data to the VCR.

MOVE

- 1 Press the **▼/▲** buttons to choose a TV channel.

Every time you press the **▼/▲** buttons, the Programme number (PR) is changed over, and the picture of the TV channel registered in the Programme number (PR) appears on the screen.

- 2 Press the **▶** button to start the MOVE function.

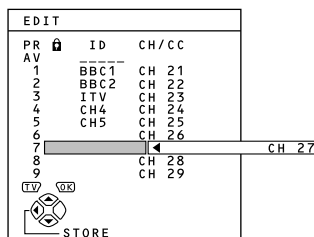

- 3 Press the **▼/▲** buttons to choose a new Programme number (PR).

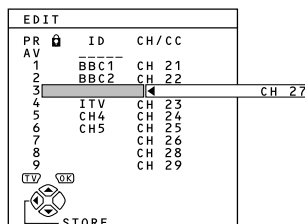

To cancel the MOVE function:

Press the **ⓘ** (Information) button.

- 4 Press the ◀ button to change the Programme number (PR) of a TV channel to a new Programme number (PR).

ID

- 1 Press the ▼/▲ buttons to choose a TV channel.

Every time you press the ▼/▲ buttons, the Programme number (PR) is changed over, and the picture of the TV channel registered in the Programme number (PR) appears on the screen.

- 2 Press the red button to start the ID function.

EDIT			
PR	ID	CH/CC	
AV			
1	BBC1	CH 21	
2	BBC2	CH 22	
3	ITV	CH 23	
4	CH4	CH 24	
5	CH5	CH 25	
6		CH 26	
7		CH 27	
8		CH 28	
9		CH 29	
			- LIST

- 3 Press the ▼/▲ buttons to choose the first character of a Channel name (ID) you want to attach to the TV channel.

EDIT			
PR	ID	CH/CC	
AV			
1	BBC1	CH 21	
2	BBC2	CH 22	
3	ITV	CH 23	
4	CH4	CH 24	
5	CH5	CH 25	
6		CH 26	
7	M	CH 27	
8		CH 28	
9		CH 29	
			- LIST

- 4 Press the blue button to display the ID LIST (channel name list).

EDIT			
PR	ID	CH/CC	
AV			
1	BBC1	CH 21	
2	BBC2	CH 22	
3	ITV	CH 23	
4	CH4	CH 24	
5	CH5	CH 25	
6		CH 26	
7	M6	CH 27	
8		CH 28	
9		CH 29	

ID LIST
M6
MBC
MCR
MOVIE
MTV
MTV3

- 5 Press the ▼/▲ buttons to choose the Channel name (ID).

To cancel the ID function:

Press the ⓘ (Information) button.

- 6 Press the OK button to register a Channel name (ID) to a TV channel.

Note:

- You can register your unique Channel name (ID) to the TV channel. When step 3 is completed, do not go to step 4, but press the ◀/▶ buttons to move the cursor and the ▼/▲ buttons to choose a character for completing the Channel name (ID). Then press the OK button to register the Channel name (ID) to the TV channel.

INSERT

Preparation:

- A CH number unique to this TV and corresponding to the Channel number of a TV channel is required. Find the corresponding CH number from a table "CH NUMBER" on page 28 based on the Channel number of the TV channel.

- 1 Press the ▼/▲ buttons to choose a Programme number (PR) for which you will register a new TV channel.
- 2 Press the green button and start the INSERT function.

EDIT			
PR	ID	CH/CC	
AV			
1	BBC1	CH 21	
2	BBC2	CH 22	
3	ITV	CH 23	
4	CH4	CH 24	
5	CH5	CH 25	
6		CH 26	
7		CH 27	
8		CH 28	
9		CH 28	

To cancel the INSERT function:

Press the ⓘ (Information) button.

- 3 Press the Number buttons to enter the remaining CH number.

The TV shifts to registration mode.

When the registration is completed, the picture of the TV channel appears on the screen.

Note:

- The CH number is a number indicating the broadcast frequency to the TV. If the TV cannot detect the TV channel corresponding to the broadcast frequency indicated by the CH number, a picture in the no-signal state appears.

DELETE

- 1 Press the ▼/▲ buttons to choose a TV channel.

Every time you press the ▼/▲ buttons, the Programme number (PR) is changed over, and the picture of the TV channel registered in the Programme number (PR) appears on the screen.

- 2 Press the yellow button to delete the TV channel.

The TV channel is deleted from the Programme numbers (PR) list.

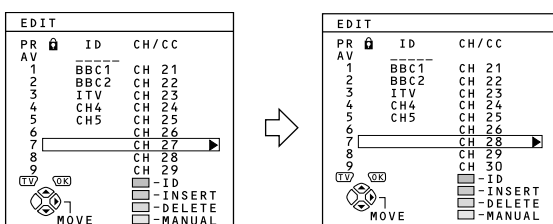

MANUAL

- 1 Press the ▼/▲ buttons to choose a Programme number (PR) to which you want to register a new TV channel.
- 2 Press the blue button to activate the MANUAL function.

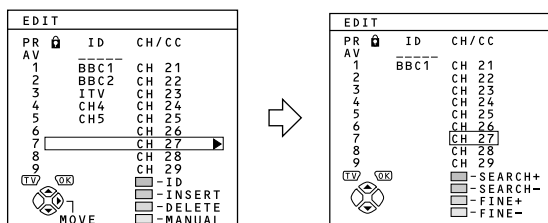

To cancel the MANUAL function:

Press the (Information) button.

- 3 Press the green or red button to search for a TV channel.

Scanning stops when the TV finds a TV channel. Then the TV channel is displayed.

- 4 Press the green or red button repeatedly until the TV channel you want appears.

If the TV channel reception is poor:

Press the blue or yellow button to fine-tune the TV channel.

- 5 Press the button and register the TV channel to a Programme number (PR).

The normal EDIT menu is resumed.



CH NUMBER

- When you want to use the INSERT function on page 27, find the CH number corresponding to the Channel number of the TV channel from this table.

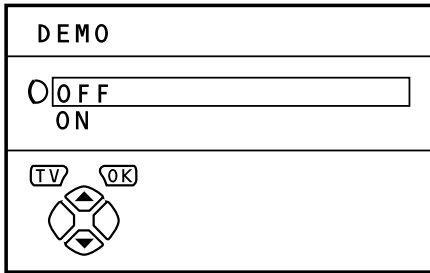

CH	Channel	CH	Channel
CH 21	E21	CH 46	E46
CH 22	E22	CH 47	E47
CH 23	E23	CH 48	E48
CH 24	E24	CH 49	E49
CH 25	E25	CH 50	E50
CH 26	E26	CH 51	E51
CH 27	E27	CH 52	E52
CH 28	E28	CH 53	E53
CH 29	E29	CH 54	E54
CH 30	E30	CH 55	E55
CH 31	E31	CH 56	E56
CH 32	E32	CH 57	E57
CH 33	E33	CH 58	E58
CH 34	E34	CH 59	E59
CH 35	E35	CH 60	E60
CH 36	E36	CH 61	E61
CH 37	E37	CH 62	E62
CH 38	E38	CH 63	E63
CH 39	E39	CH 64	E64
CH 40	E40	CH 65	E65
CH 41	E41	CH 66	E66
CH 42	E42	CH 67	E67
CH 43	E43	CH 68	E68
CH 44	E44	CH 69	E69
CH 45	E45		



To display the DEMO menu:

- 1 Press the  button to display MENU (main menu).**
- 2 Press the  button to choose DEMO. Then press the  button.**

The DEMO function automatically demonstrates some of the TV functions.

- 1 Press the  buttons to choose ON.**
- 2 Press the  button to complete the settings.**

The DEMO function is set to ON, and the demonstration will start.

To stop the demonstration:

Press one of the buttons on the remote control.

When the DEMO function is set to ON:

Each time the TV is turned on, the demonstration starts automatically. If you do not want that to happen, perform the following operations to cancel the DEMO function:

- 1 Display the DEMO menu again.**
- 2 Press the  buttons to choose OFF.**
- 3 Press the  button to cancel the DEMO function.**

ADDITIONAL MENU OPERATIONS

■ Downloading the data to VCR

You can transmit to the latest Programme numbers (PR) data to the VCR with the T-V LINK function.

Caution:

- Only when the T-V LINK compatible VCR is connected to the EXT-2 terminal, this operation is enabled.
- Only when the T-V LINK menu is being displayed, this operation is enabled.

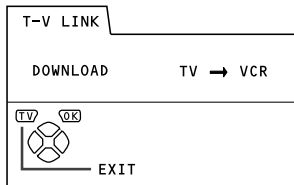

1 Turn on the VCR.

2 Press the button.

The data transmission begins.

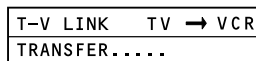

The T-V LINK menu disappears once the data transmission ends.

When the T-V LINK menu is changed over to another menu:

The menu operation at the TV side is completed and it is shifted to the menu operation at the VCR side. Refer to the VCR Instruction Manual and operate the VCR.

Note:

- If "FEATURE NOT AVAILABLE" appears at the T-V LINK menu, ensure the following three items are correct; then press the button to retry data transmission.
 - Has the T-V LINK compatible VCR been connected to the EXT-2 terminal?
 - Has the VCR power been turned on?
 - Does the SCART cable that is connected to the EXT-2 terminal to T-V LINK compatible VCR have all proper connections?

■ Using the DECODER (EXT-2) function

When connecting a Decoder with a T-V LINK compatible VCR connected to the EXT-2 terminal, use the DECODER (EXT-2) function to unscramble the scrambled TV channels.

1 Turn on the Decoder power.

2 Display the TV channel capable of being unscrambled with the Decoder on the TV.

Even if the Decoder is functioning, a scrambled picture appears at this time.

3 Press the button to display the MENU.

The MENU (main menu) appears.

4 Press the / buttons to choose FEATURES. Then press the button.

The FEATURES menu appears.

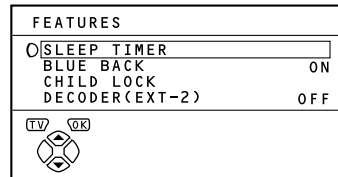

5 Press the / buttons to choose DECODER (EXT-2). Then press the / buttons to choose ON.

An unscrambled picture appears.

To cancel the DECODER (EXT-2) function:

Press the / buttons to choose OFF.

6 Press the button to complete the setting.

The T-V LINK menu appears.

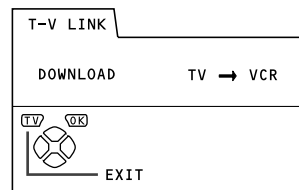

7 Follow the operating procedure "Downloading the data to VCR" on page 30 to transmit the Programme number (PR) data to the VCR.





8 If you have another TV channel capable of being unscrambled with a Decoder, repeat steps 2 through 7.

Note:

- If for some reason the DECODER (EXT-2) function has been set to "ON" but the TV channel cannot be unscrambled, check the following:
 - Has the Decoder been connected to the VCR properly according to the VCR and Decoder Instruction Manuals?
 - Has the Decoder power been turned on?
 - Can the TV channel be unscrambled with a Decoder?
 - Is it necessary to change the VCR settings in order to connect the Decoder? Confirm that the VCR is set properly by rechecking the VCR Instruction Manual.





■ Setting the SPEAKER function

Turn off the SPEAKER function so that TV speakers will not issue any sound.

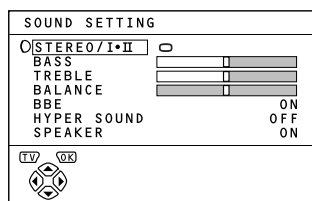
1. Press the  button to display the MENU (main menu).
2. Press the / buttons to choose SOUND SETTING. Then press the  button to display the SOUND SETTING menu.

The SOUND SETTING menu appears.





3. Press the / buttons to choose SPEAKER. Then press the / buttons to choose OFF.

The sound from the TV speakers are cut.

4. Press the  button to complete the settings.

The menu disappears.

Note:

- The / buttons of the TV remote control and the  (volume) buttons at the front panel of your TV set can be used to control the volume of each speaker simultaneously.
- Setting the volume of the amplifier too high may damage the front speakers.

ADDITIONAL PREPARATION

■ Connecting the external devices

Connect the devices to the TV, paying attention to the Rear panel connections and the Front panel connections.

Before connecting anything:

- Read the manuals provided with the devices. Depending on the devices, the connection method may differ from the figure. In addition, the device settings may be changed depending on the connection method to secure proper operation.
- Turn off all the devices including the TV.
- The "SPECIFICATIONS" on the back cover contains the details of the EXT terminals. If you are connecting a device not listed in the following connection diagram, see the table to choose the best EXT terminal.
- Note that connecting cables are not supplied.

- ① VCR (composite signal)
- ② VCR (composite signal/S-VIDEO signal)
- ③ T-V LINK compatible VCR (composite signal/S-VIDEO signal)
- ④ Decoder
- ⑤ DVD player (composite signal/S-VIDEO signal)
- ⑥ DVD player (composite signal/RGB signal)
- ⑦ TV game (composite signal/RGB signal)
- ⑧ TV game (composite signal/S-VIDEO signal)
- ⑨ Headphones
- ⑩ Camcorder (composite signal/S-VIDEO signal)
- ⑪ SCART cable
- ⑫ Audio cable
- ⑬ Video cable
- ⑭ S-VIDEO cable

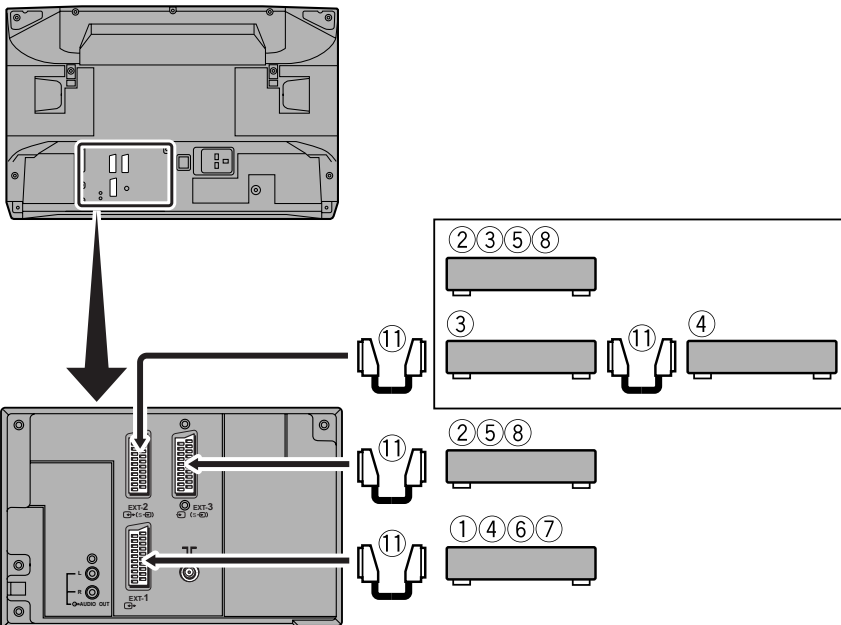
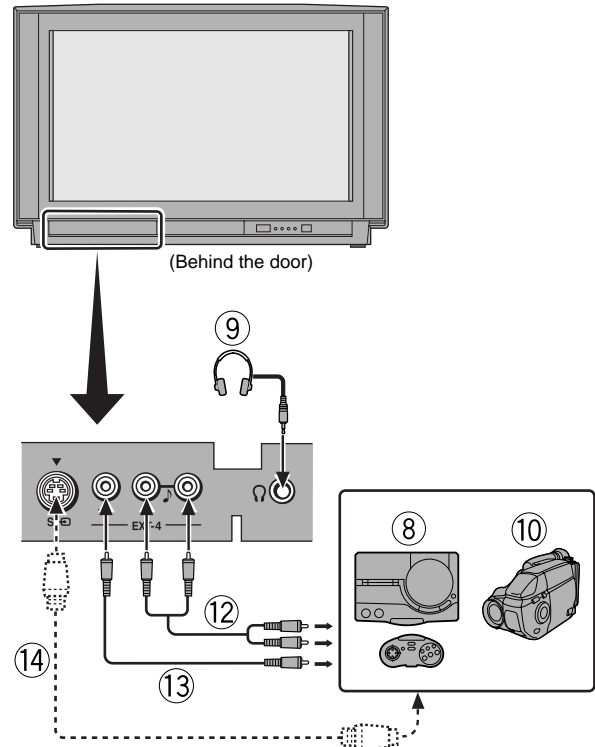

Devices which can output the S-VIDEO signal (Y/C signal) such as a S-VHS VCR

Connect the device to an EXT terminal other than the EXT-1 terminal.

You can choose a video input signal from the S-VIDEO signal (Y/C signal) and regular video signal (composite signal). For details of how to operate the device, see "S (S-VIDEO input)" on page 21.

T-V LINK compatible VCR

Be sure to connect the T-V LINK compatible VCR to the EXT-2 terminal. If not, the T-V LINK function will not work properly.

Note:

- When connecting a T-V LINK compatible VCR to the EXT-2 terminal, be sure to connect the Decoder to the VCR. If not, the T-V LINK function may not work properly. After you have registered TV channels to the Programme numbers (PR), set the DECODER (EXT-2) function for the Programme number (PR) to ON in order to unscramble a scrambled TV channel. For details of operation, see "Using the DECODER (EXT-2) function" on page 30.

Connecting headphones

Connect the headphones with a stereo mini-jack (of 3.5mm in diameter) to the headphone jack at the TV front panel.

Note:

- When you connect the headphones, the TV speakers issue no sound.

Video/sound signal output from the EXT-2 terminal

You can arbitrarily change over the output of the video/sound signal from the EXT-2 terminal. It is useful when you want to dub the video/sound from another device on the VCR connected to the EXT-2 terminal. For details on how to do this operation, see "DUBBING" on page 22.

TV output from the EXT-1 terminal

The output of video/sound signal of a TV channel you are currently viewing is always output from the EXT-1 terminal.

Note:

- Changing over a Programme number (PR) also changes over the TV output from the EXT-1 terminal.
- The video/sound signal from an EXT terminal cannot be output.
- Teletext programmes cannot be output.

■ Connecting Speakers/Amplifier

While referring to the Audio equipment connection diagram, connect the audio equipment you desire to the TV.

You can use external front speakers to listen to the TV sound instead of the TV speakers. For details of how to operate them, see "Setting the SPEAKER function" on page 31.

Before connecting anything:

- Read the manuals provided with the amplifier and speakers.
- Turn the TV and Amplifier off.
- To prevent magnetism from the speakers adversely affecting the TV screen, use magnetic-shielded speakers for the front speakers.
- Note that connecting cables are not supplied.

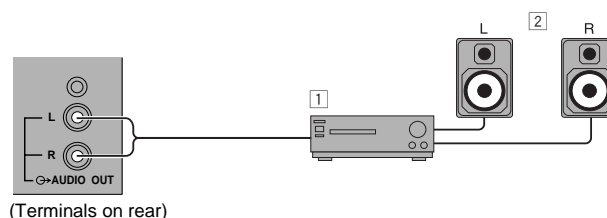

- 1 Amplifier
- 2 Front speakers (Magnetic-shielded type)

Note:

- The output from the AUDIO OUT terminal is not interrupted by headphone connection to the TV. You cannot cut the sound from the front speaker even if you connect a headphone to the TV.

TV BUTTONS AND PARTS

■ Front Panel

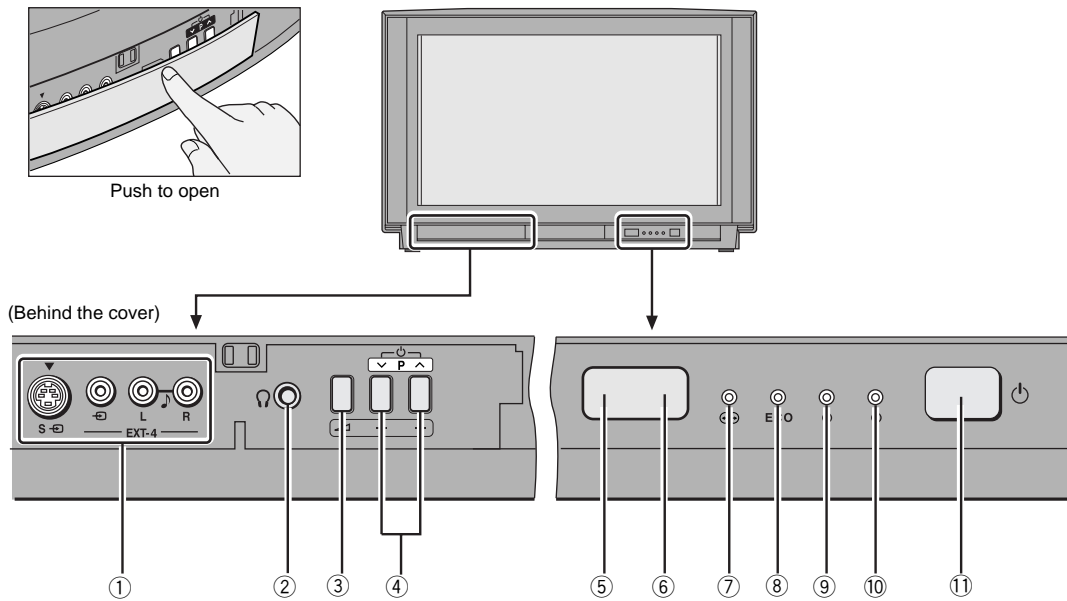

① EXT-4 terminal	pages 21 and 32
② Headphone jack (mini jack)	pages 32
③ (Volume) button	page 10
④ P buttons / buttons	page 10
⑤ Remote control sensor	
⑥ ECO sensor	

⑦ HYPER SOUND lamp	pages 12 and 20
⑧ ECO lamp	page 17
⑨ SLEEP TIMER lamp	page 23
⑩ Power lamp	pages 5 and 8
⑪ Main power button	pages 5 and 8

Caution:

• Do not grasp the TV by the front panel cover when moving the TV set. If you do, you may break the cover.

■ Rear Panel

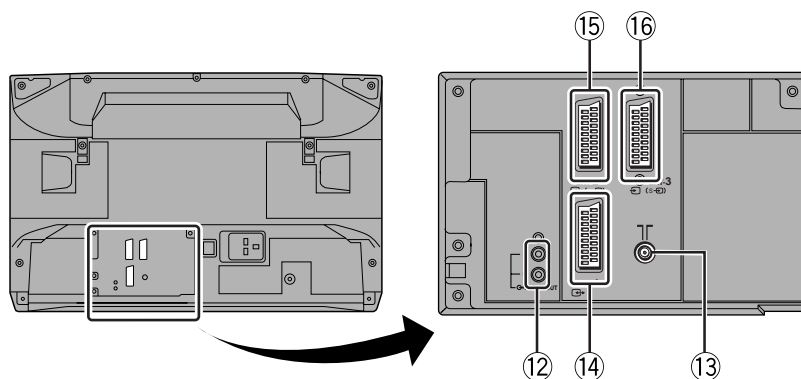

⑫ AUDIO OUT terminal	page 33
⑬ Aerial socket	page 4
⑭ EXT-1 terminal	pages 4, 21 and 32

⑮ EXT-2 terminal	pages 4, 7, 21 and 32
⑯ EXT-3 terminal	pages 21 and 32

TROUBLESHOOTING

www.DataSheet4U.com

If a problem arises while you are using the TV, please read this "Troubleshooting" well before you request having the TV repaired. You may be able to fix it easily by yourself. For example, if the AC plug is disconnected from the AC outlet, or the TV aerial has problems, you may think there is a problem with the TV itself.

Important:

- This Troubleshooting guide only covers problems whose cause are not easy to determine. If a question arise when you are operating a function, read the page(s) corresponding to the operation of the function well, not this Troubleshooting guide.
- After you have followed the Troubleshooting description or the operating description of the functions concerned without any success, remove the AC plug from the AC outlet and request a repair of your TV. Do not attempt to repair the TV by yourself or remove the rear cover of the TV.

If you cannot turn on the TV

- Is the AC plug connected to the AC outlet?
- Is the Power lamp lit? If not, press the Main power button.

No picture/No sound

- Have you chosen a TV channel whose reception is extremely bad? In this case, the BLUE BACK function will be activated, the entire screen becomes blue, and the sound is muted. In spite of this, if you want to view the TV channel, follow the description "BLUE BACK" on page 23 to try to change the BLUE BACK function setting to OFF.
- Have you connected the headphones to the TV? Connecting the headphones to the TV causes sounds not to be issued from the TV speakers.
- Have you set the SPEAKER function to OFF? Follow the description "SPEAKER" on page 20 to confirm the SPEAKER function setting to try to solve the problem.

Poor picture

- If noise totally obscures the picture (snow), the aerial or aerial cable may have trouble. Check the following to try to solve the trouble:

Has the TV and aerial been connected properly?

Has the aerial cable been damaged?

Is the aerial pointed to the right direction?

Is the aerial itself faulty?

- If the TV or aerial receives interference from the other devices, stripes or noise may appear in the picture. Move such devices as an amplifier, personal computer, or a hair drier that can cause interference away from your TV, or try changing its location. If the aerial suffers interference from a radio tower or high-voltage wire, please contact your local dealer.
- If the TV receives interference from signal reflecting from mountains or building, double-pictures (ghosting) will occur. Try to change the aerial's direction or replace the antenna with the one with better directionality.
- Are your COLOUR SYSTEM settings correct? Follow the description "COLOUR SYSTEM" on page 18 to try to solve the trouble.
- Has COLOUR or BRIGHT been controlled properly? Follow the description "Picture Adjustment" on page 17 to try to adjust them properly.
- Videotaping teletext is not recommended because it may not record correctly.
- When a white and bright still image (such as a white dress) is displayed on the screen, the white part may look as if it were coloured. It is a phenomenon unavoidable due to the nature of the picture tube itself, and not due to a TV failure. When the picture disappears from the screen, the unnatural colours will also disappear.

Poor sound

- Have you adjusted BASS or TREBLE properly? If not, follow the description "Sound Adjustment" on page 20 to try to adjust them properly.

- When the TV channel reception is poor, it can be hard to hear the stereo or bilingual sound. In this case, follow the description "STEREO / I•II" on page 20 to hear the sound more easily by changing it to a mono sound.

Operation disabled

- Have the batteries of the remote control become exhausted? Follow the description "Putting Batteries into the Remote Control" on page 4 and replace them with new batteries to try to solve the problem.
- Have you attempted to use the remote control at the sides or rear of the TV or at a location more than seven meters apart from the TV location? Operate the remote control in the front of your TV or a location less than seven meters from your TV to try to solve the problem.
- When you are viewing a teletext programme, you cannot operate the menus. Press the  button to return the teletext programme to the ordinary TV programme to try operating the menus.
- If the TV operation becomes disabled suddenly, press the Main power button on the TV and turn off the main power. Try to press the Main power button again to turn on the main power. If the TV returns to a normal state, it is not a failure.

Other concerns

- When the SLEEP TIMER function operates, the TV is automatically turned off. If the TV is turned off suddenly, try to press the  (Standby) button to turn on the TV once again. At this time, if the TV resumes a normal state, there is no problem.
- When the TV is receiving a wide-screen signal (WSS) or a signal concerning the screen size from an external device, the ZOOM mode automatically changes. When you want to resume the previous ZOOM mode, press the ZOOM button again.
- If you bring a magnetised device such as a speaker near to your TV, a picture may be warped or unnatural colors appear at the corners of the screen. In this case, keep the device apart from your TV. If the speakers causes such phenomena, use the magnetic-shielded speakers instead.
- A picture may be tilted due to the influence of the earth's magnetism. In this case, use the "PICTURE TILT" on page 19 to complete the tilt.
- The TV may emit a crackling sound due to a sudden change in temperature. It does not matter if a picture or sound does not show any abnormality. If you hear crackling sounds frequently while you are viewing the TV, other causes may be assumed. For precautionary purposes, request your service technician to inspect it.
- Touching the screen may cause you feel a slight electric shock due to its static electricity. It is an unavoidable phenomenon due to the construction of the picture tube. It is not a problem with the TV. You can rest assured that this static discharge does not have harmful influence over the human body.

SPECIFICATIONS

Item	Model	AV-32WFT1EK*	AV-28WFT1EK*
Broadcasting systems		CCIR I	
Colour systems		PAL • The EXT terminals also support the NTSC 3.58/4.43 MHz system.	
Channels and frequencies		E21-E69	
Sound-multiplex systems		NICAM (I) system	
Teletext systems		FLOF (Fastext), WST (World Standard System)	
Power requirements		220 - 240 V AC, 50 Hz	
Power consumption		Maximum: 172 W, Average: 121 W, Standby: 0.8 W	Maximum: 168 W, Average: 115 W, Standby: 0.8 W
Picture tube size		Viewable area 76 cm (measured diagonally)	Viewable area 66 cm (measured diagonally)
Audio output		Rated Power output: 7.5 W + 7.5 W	
Speakers		10 cm round × 2	(16cm × 4cm) oval × 2
EXT-1 terminal		Euroconnector (21-pin, SCART) • Video input, Audio L/R inputs and RGB inputs are available. • TV broadcast outputs (Video and Audio L/R) are available.	
EXT-2 terminal		Euroconnector (21-pin, SCART) • Video input, S-VIDEO (Y/C) input and Audio L/R inputs are available. • Video and Audio L/R outputs are available. • T-V LINK functions are available.	
EXT-3 terminal		Euroconnector (21-pin, SCART) • Video input, S-VIDEO (Y/C) input and Audio L/R inputs are available.	
EXT-4 terminal		RCA connectors × 3 S-VIDEO connector × 1 • Video input, S-VIDEO (Y/C) input and Audio L/R inputs are available.	
AUDIO OUT terminal		RCA connectors × 2 • Variable audio L/R outputs are available. • Variable out 0-1 Vrms, low impedance	
Headphone jack		Stereo mini-jack (3.5 mm in diameter)	
Dimensions (W × H × D)		855 mm × 550 mm × 568 mm	780 mm × 509 mm × 499 mm
Weight		56.5 kg	39 kg
Accessories		Remote control unit RM-C51 × 1 AAA/R03 dry cell battery × 2	

* A basic model number. The actual model number may have characters added (such as "S" denoting silver) indicating the colour of the TV set.

Design and specifications subject to change without notice.

Pictures displayed on the screen using this TV's ZOOM functions should not be shown for any commercial or demonstration purpose in public places (cafes, hotels, etc.) without the consent of the owners of copyright of the original picture sources, as this constitutes an infringement of copyright.

JVC