

TOSHIBA

FILE NO. 030-200508

SERVICE MANUAL

LCD Color Television

32WLT58
37WLT58



TABLE OF CONTENTS

SERVICE SAFETY PRECAUTIONS	3
HANDLING THE LCD MODULE	5
SERVICE MODE	7
LOCATION OF CONTROLS	12
LAYOUT OF MAJOR BOARDS	14
MECHANICAL DISASSEMBLY	15
EXPLODED VIEWS	17
PACKING DISASSEMBLY	19
CHASSIS AND CABINET REPLACEMENT PARTS LIST	20
PC BOARDS TOP & BOTTOM VIEW	30
CIRCUIT BLOCK DIAGRAM	46
SPECIFICATIONS	50
APPENDIX:	
SCHEMATIC DIAGRAM	





SERVICE SAFETY PRECAUTIONS











- The caution items shown here describe major safety issues and should always be observed.
- The meanings of the various indications are as follows.

 WARNING	Indicates a hypothetical situation in which service personnel and nearby third parties, or even end users due to a product defect after the service operation is completed, could possibly be in danger of injury or even death in the event of operational error.
 CAUTION	Indicates a hypothetical situation in which service personnel and nearby third parties, or even end users after the service operation is completed, could possibly be in danger of injury, or where there could be physical damage in the event of operational error.

* Physical damage means major damage to a home, furnishings and other possessions.

Examples of marks

 SHOCK HAZARD	The Δ indicates caution (including danger and warning). The actual meaning of this caution is indicated inside the Δ or nearby illustrations or text. The example shown to the left indicates the danger of "electrical shock".
 PROHIBIT DISASSEMBLING	The \ominus indicates a forbidden action. The actual meaning of this caution is indicated inside the \ominus or nearby illustrations or text. The example shown to the left indicates that disassembly is forbidden.
 UNPLUG	The \bullet indicates a forced action (an action that must be performed). The actual meaning of this forced action is indicated by \bullet or nearby illustrations or text. The example shown to the left indicates that the power plug must be disconnected.

	 WARNING
 KEEP CHILDREN AWAY	<ul style="list-style-type: none"> Always advise users to keep children away. There is danger of injury to children from tools, disassembled products, etc.
 UNPLUG	<ul style="list-style-type: none"> Always disconnect the power plug before starting work whenever power is not required. Failure to disconnect the power plug before starting work can result in electrical shock.
 SHOCK HAZARD	<ul style="list-style-type: none"> Depending on the model, use an insulation transformer or wear gloves when servicing with the power on, and disconnect the power plug to avoid electrical shock when replacing parts. In some cases, alternating current is also impressed in the chassis, so electrical shock is possible if the chassis is contacted with the power on.
 USE SPECIFIED PARTS	<ul style="list-style-type: none"> Always use the replacement parts specified for the particular model when making repairs. The parts used in products have the necessary safety characteristics such as inflammability, voltage resistance, etc.; therefore, use only replacement parts that have these same characteristics. Use only the specified parts when the  mark is included in a circuit diagram or parts list.
 CAUTION FOR WIRING	<ul style="list-style-type: none"> Parts mounting and routing of the wiring should be the same as that used originally. For safety purposes, insulating materials such as tubing or tape is sometimes used and potted circuit boards are sometimes mounted floating. Also make sure that wiring is routed and clamped to avoid parts that generate heat and which use high voltage. Always follow the original scheme.
 CAUTION FOR ASSEMBLING / WIRING	<ul style="list-style-type: none"> After a repair has been completed, reassemble all disassembled parts, and route and reconnect the wiring, in accordance with the original scheme. Do not allow internal wiring to be pinched by cabinets, panels, etc. Any error in reassembly or wiring can result in electrical leakage, flame, etc., and may be hazardous.
 CHECK INSULATION RESISTANCE	<ul style="list-style-type: none"> After completing the work, disconnect the power plug from the outlet, remove the antenna, turn on the power switch. Then, use a 500V insulation resistance meter to check the insulation resistance of the antenna terminal, other metallic parts and between the prongs of the power plug to make sure that the insulation resistance is 1M Ω or more. The set will require inspection and repair if the insulation resistance is below this value.
 PROHIBIT REMODELING	<ul style="list-style-type: none"> Never remodel the product in any way. Remodeling can result in improper operation, malfunction, or electrical leakage and flame, which may be hazardous.

HANDLING THE LCD MODULE

Safety Precautions

In the event that the screen is damaged or the liquid crystal (fluid) leaks, do not breathe in or drink this fluid. Also, never touch this fluid.

Such actions could cause toxicity or skin irritation. If this fluid should enter the mouth, rinse the mouth thoroughly with water. If the fluid should contact the skin or clothing, wipe off with alcohol, etc., and rinse thoroughly with water. If the fluid should enter the eyes, immediately rinse the eyes thoroughly with running water.

Precautions for Handling the LCD Module

The LCD module can easily be damaged during disassembly or reassembly; therefore, always observe the following precautions when handling the module.

1. When attaching the LCD module to the LCD cover, position it appropriately and fasten at the position where the display can be viewed most conveniently.

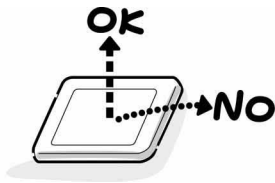

2. Carefully align the holes at all four corners of the LCD module with the corresponding holes in the LCD cover and fasten with screws. Do not strongly push on the module because any impact can adversely affect the performance. Also use caution when handling the polarized screen because it can easily be damaged.

CAUTION

The metal edges of the LCD module are sharp, so use caution to avoid injury.

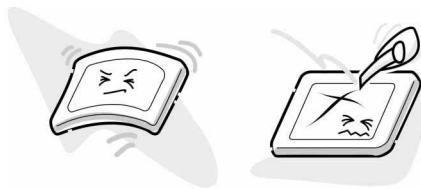

3. If the panel surface becomes soiled, wipe with cotton or a soft cloth. If this does not remove the soiling, breathe on the surface and then wipe again.

If the panel surface is extremely soiled, use a CRT cleaner as a cleaner. Wipe off the panel surface by drop the cleaner on the cloth. Do not drop the cleaner on the panel. Pay attention not to scratch the panel surface.



4. Leaving water or other fluids on the panel screen for an extended period of time can result in discoloration or stripes. Immediately remove any type of fluid from the screen.



5. Glass is used in the panel, so do not drop or strike with hard objects. Such actions can damage the panel.



6. CMOS-LSI circuitry is used in the LCD module, so avoid damage due to static electricity. When handling the module, use a wrist ground or anchor ground.

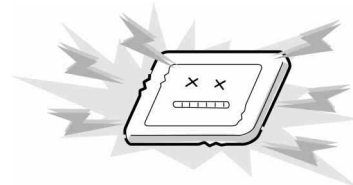

7. Do not expose the LCD module to direct sunlight or strong ultraviolet rays for an extended period of time.

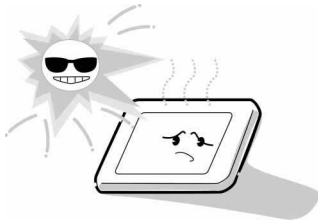

8. Do not store the LCD module below the temperature conditions described in the specifications. Failure to do so could result in freezing of the liquid crystal due to cold air or loss of resilience or other damage.

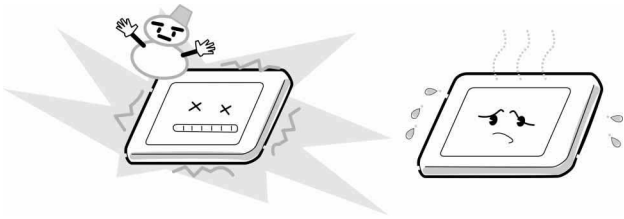

9. Do not disassemble the LCD module. Such actions could result in improper operation.

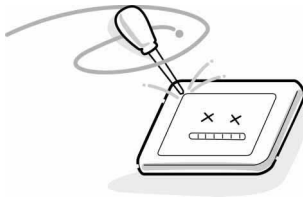

10. When transporting the LCD module, do not use packing containing epoxy resin (amine) or silicon resin (alcohol or oxim). The gas generated by these materials can cause loss of polarity.

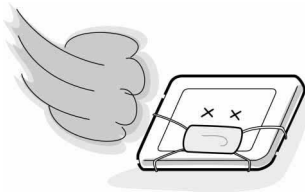

SERVICE MODE

1. ENTERING SERVICE MODE

- 1) Press MUTE button once on Remote Control.
- 2) Press MUTE button again and keep pressing.
- 3) While pressing the MUTE button, press MENU button on TV set.

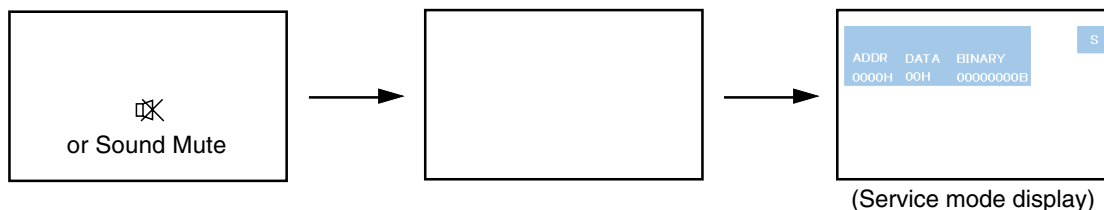

2. DISPLAYING THE ADJUSTMENT MENU

- 1) Press MENU button on TV.

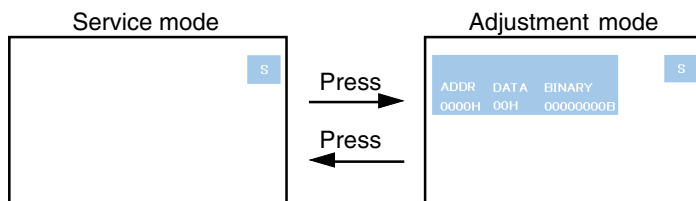

3. KEY FUNCTION IN THE SERVICE MODE

The following key entry during display of adjustment menu provides special functions.

Test signal selection :	MUTE button (on Remote)
Selection of the adjustment items :	Channel $\blacktriangle/\blacktriangledown$ (on TV or Remote)
Change of the data value :	Volume $\blacktriangle/\blacktriangledown$ +/- (on TV or Remote)
Adjustment menu mode ON/OFF :	MENU button (on TV)
Initialization of the memory :	CALL + Channel button on TV (\blacktriangle)
Reset the count of operating protect circuit to "00":	CALL + Channel button on TV (\blacktriangledown)
"RCUT" selection :	1 button
"GCUT" selection :	2 button
"BCUT" selection :	3 button
"SCNT" selection :	4 button
"COLP" selection :	5 button
"TNTC" selection :	6 button
Automatic A/D Adjustment(PC, Component):	7 button
Self diagnostic display ON/OFF :	9 button

----- Color thickness correction
 note: Displayed differently as shown below, depending on the setting of the receiving color system.
 COLP (PAL)
 COLC (NTSC)
 COLS (SECAM)

CAUTION : Never try to perform initialization unless you have changed the memory IC.

4. SELECTING THE ADJUSTING ITEMS

- 1) Every pressing of CHANNEL ▲ button in the service mode changes the adjustment items in the order of table-2.
(▼ button for reverse order)

5. ADJUSTING THE DATA

- 1) Pressing of VOLUME ▲ +/- button will change the value of data in the range from 00H to FFH. The variable range depends on the adjusting item.

6. EXIT FROM SERVICE MODE

- 1) Pressing POWER button to turn off the TV once.

■ INITIALIZATION OF MEMORY DATA

After replacing EEPROM IC, the following initialization is required.

1. Enter the service mode, then select any register item.
2. Press and hold the CALL button on the Remote, then press the CHANNEL▲ button on the TV. The initialization of EEPROM IC has been completed.
3. Check the picture carefully. If necessary, adjust any adjustment item above.
Perform "Auto tune" on the owner's manual.

CAUTION: Never attempt to initialize the data unless EEPROM IC has been replaced.

7. TEST SIGNAL SELECTION

- 1) Every pressing of -⊖ button on the Remote Control changes the built-in test patterns on screen as described below in SERVICE MODE.

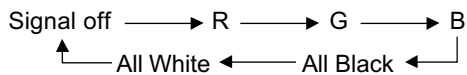

Signals	Picture
<ul style="list-style-type: none">• Red raster• Green raster• Blue raster• All Black• All White	

8. SELF DIAGNOSTIC FUNCTION

- 1) Press "9" button on Remote Control during display of adjustment menu in the service mode.
The diagnosis will begin to check if interface among IC's is executed properly.
- 2) During diagnosis, the following displays are shown.



⑦⑧

- ① Firmware :
Version information of microprocessor
In case of file name : WL58_EU and Version : 0100 indicates[WL58_EU_0100].
- ② Time : Total hour of turn the TV on. (Unit : H)
- ③ Power : Operation number of protecting circuit ----"000" is normal.
When indication is other than "000", overcurrent apt to flow, and circuit parts may possibly be damaged.
- ④ Bus line : --"OK" is normal
"SCL-GND"(Red indication) : SCL-GND short circuit
"SDA-GND"(Red indication) : SDA-GND short circuit
"SCL-SDA"(Red indication) : SCL-SDA short circuit
- ⑤ Bus cont : --- "OK" is normal.
NG is abnormal(Red indication), when
type name of semiconductor indicates.
- ⑥ Block
UV: TV reception mode
V1 : SCART1(EXT1) input mode (→ 1)
V2 : SCART2(EXT2) input mode (→ 2)
V3 : SCART3(EXT3) input mode (→ 3)
V4 : COMPONENT VIDEO input mode (→ 4C)
V5 : Side COMPOSITE input mode (→ 5)
V6 : HDMI 1 mode
V7 : HDMI 2 mode
PC : Personal Computer input mode
DTV : DTV reception mode
- ⑦ 8 digit : CD number
- ⑧ Model name (7 digit)

9. VERSION CHECK MODE

- 1) Press “9” button twice on Remote Control during display of adjustment menu in the service mode. The version of main MPU will begin to check.
- 2) During Version Check, the following displays are shown.

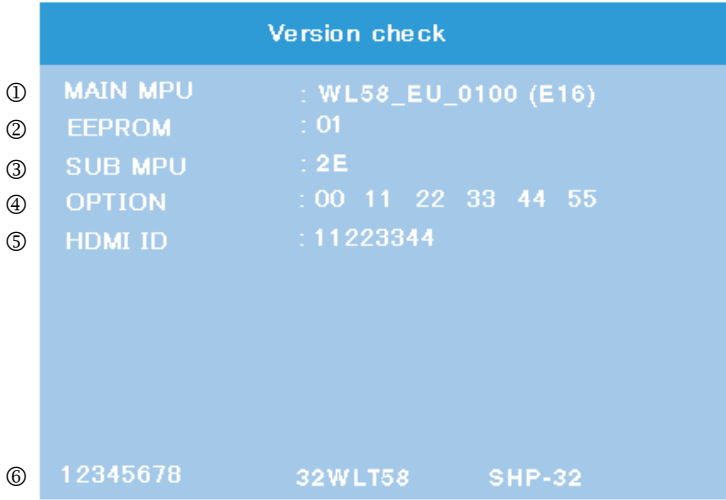

⑦ ⑧

- ① MAIN MPU :
Version information of microprocessor
In case of file name : WL58_EU, Version 0100 for Code Program Version and (E16) for OSD Version indicates [WL58_EU_0100(E16)]
- ② EEPROM :
Version information of EEPROM : Display 1 byte data.
- ③ SUB MPU :
Version information of SUB MPU : Display 1 byte data.
- ④ OPTION :
Option information : Display six numbers of 1 byte data.
- ⑤ HDMI ID :
HDMI ID information : Display 4 byte data.
- ⑥ CD number : Display 8 digit number
- ⑦ Model name : Display 7 digit number
- ⑧ Panel Vender information display
The following Panel Vender and screen size are displayed.

Panel	Panel Vender	Screen Size(Inch)
LCD	LPL	-23
	SHP	-26
	CMO	-32
		-37
		-42
PDP	LG	-42

Example : SHP-32 indicates that Vender is SHP and Screen Size is 32 inch.

10. STATUS CHECK MODE

- 1) Press "9" button thrice on Remote Control during display of adjustment menu in the service mode. The status of this model will begin to check.
- 2) During Status Check, the following displays are shown.

Status check	
①	MAIN : EXT1
②	MAIN FORMAT : 1080i-50
③	MAIN PLL : C6 38 54 CE 08
④	SCREEN SIZE : Super live
⑤	OTHER STATUS : 0000 0000 0000

- ① MAIN :
Main source information :
Display RF position number (0 - 99) on the main screen, or Input Source (EXT1/2/3/HDMI etc.)
- ② MAIN FORMAT :
Display Video and PC format information
- ③ MAIN PLL :
Main PLL information : Display five numbers of 1 byte data.
- ④ SCREEN SIZE :
Display the screen size as follows.

Super live
Cinema
Subtitle
14:9
Wide
4:3

- ⑤ OTHER STATUS :
Other status information : Display three numbers of 2 byte data.

LOCATION OF CONTROLS

Front

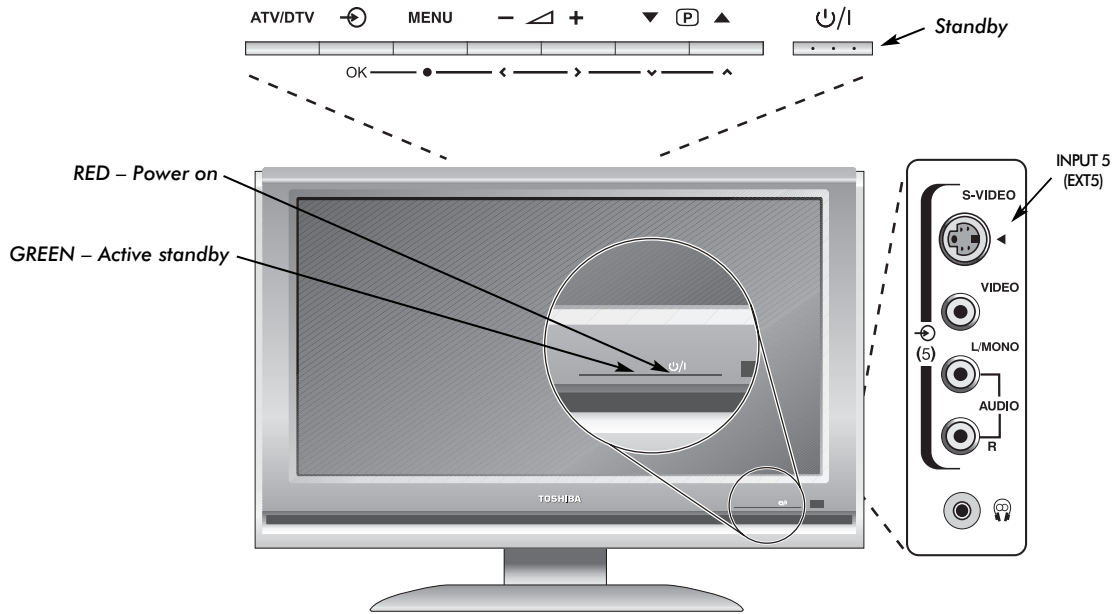

Back

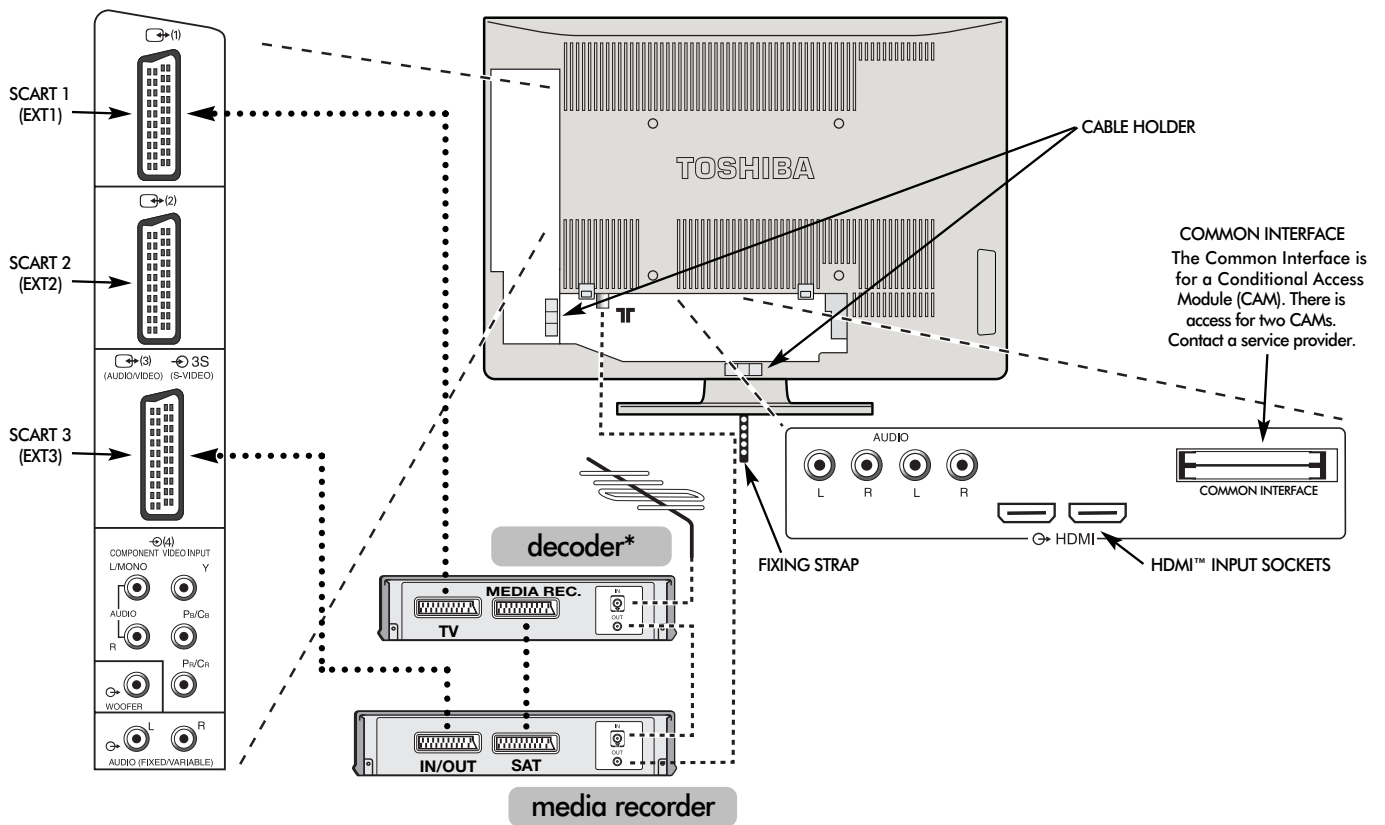

Remote control

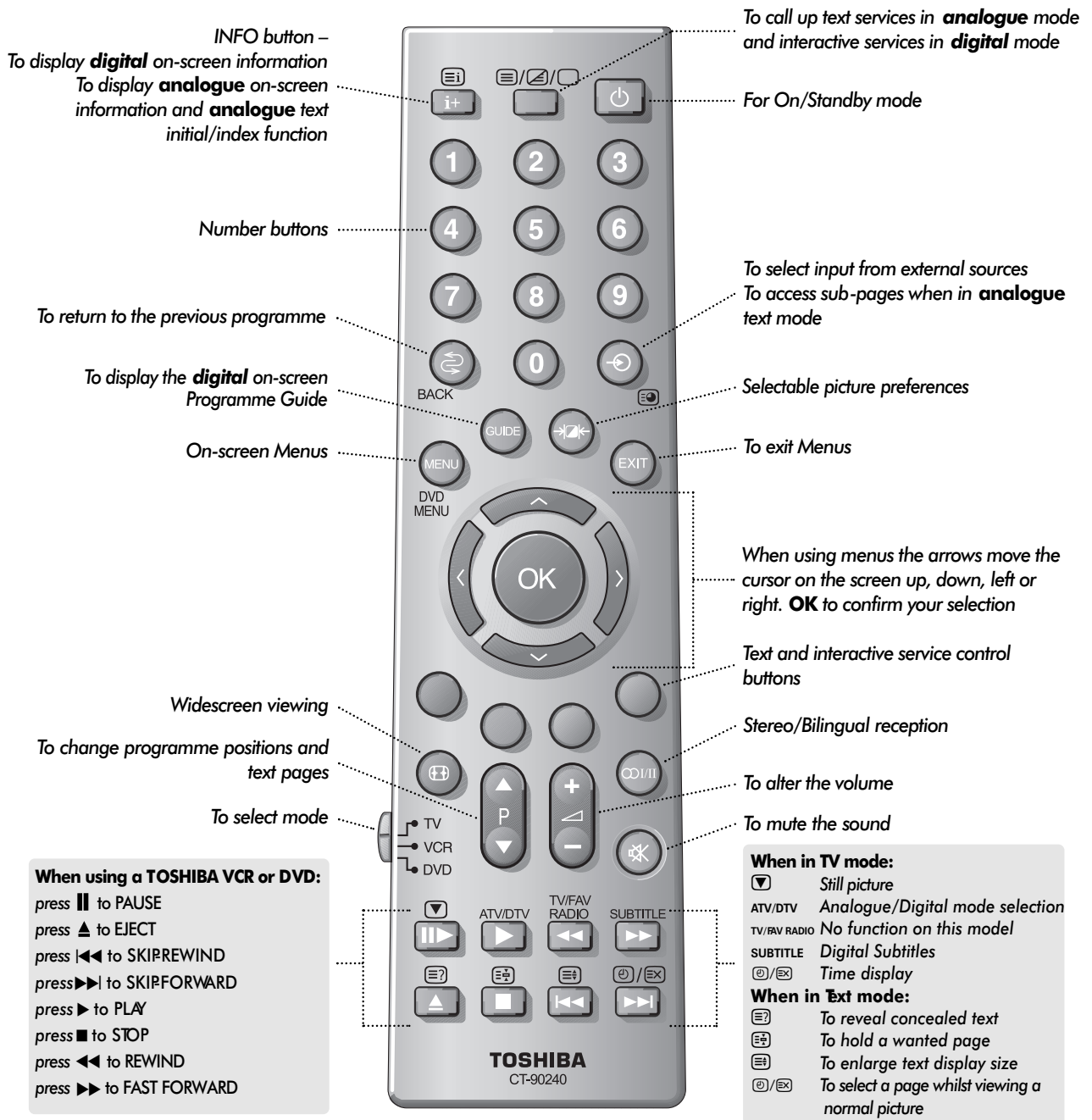

LAYOUT OF MAJOR BOARDS

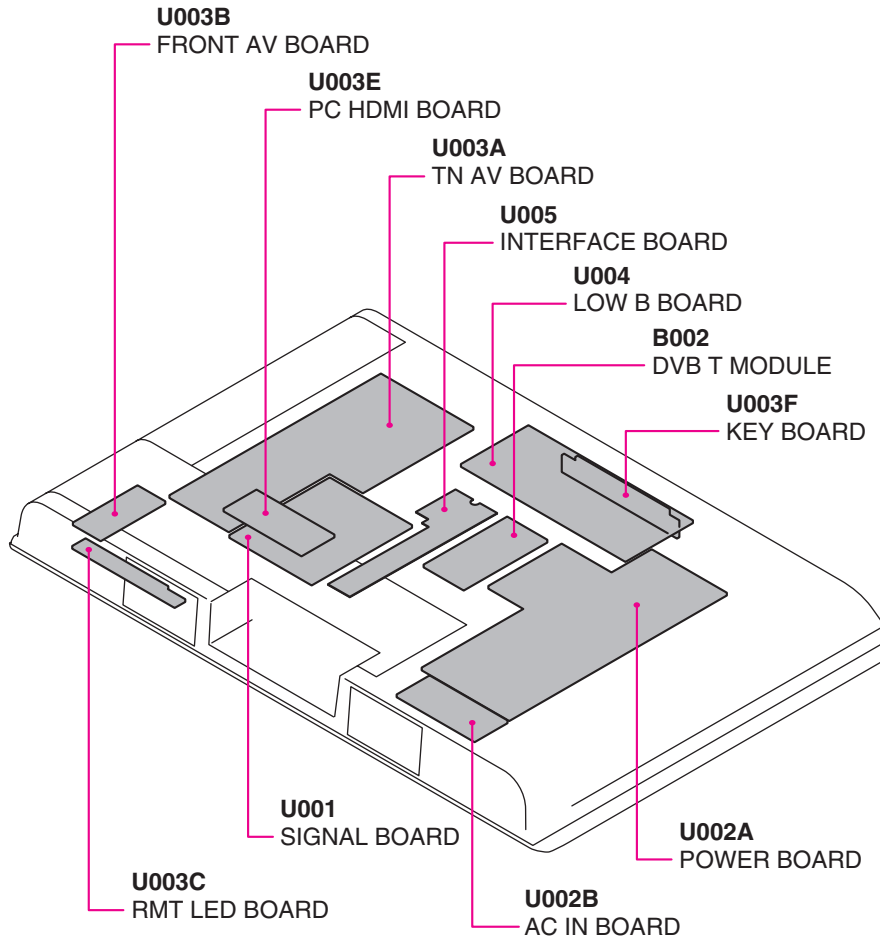

MECHANICAL DISASSEMBLY (Representative of 32WLT58)

1. Remove the stand (foot) and back cover.

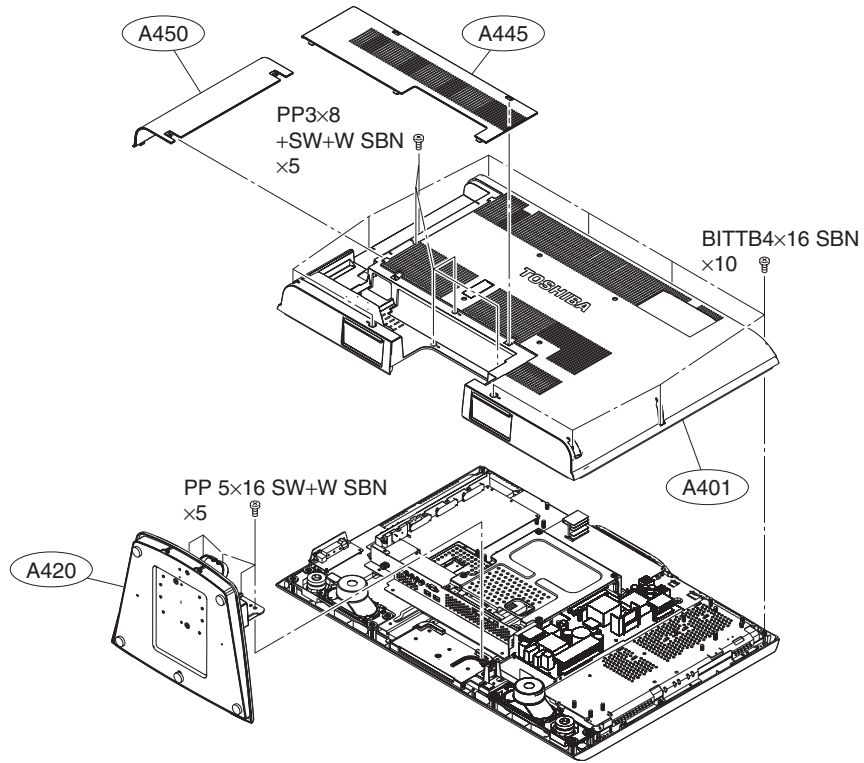

2. Remove the boards (FRONT AV,PC HDMI, KEY) and back center cover.

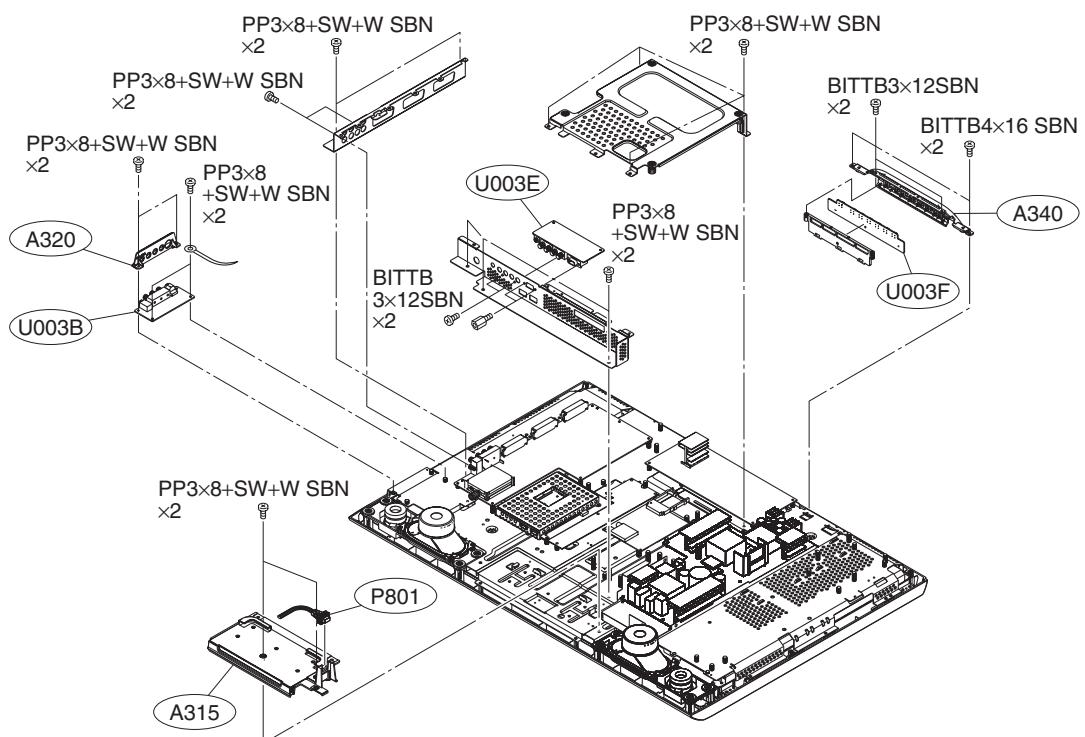

3. Remove the boards (POWER, AC-IN, SIGNAL, LOW B, TN AV, RMT LED, INTERFACE, DVB T MODULE) and speakers.

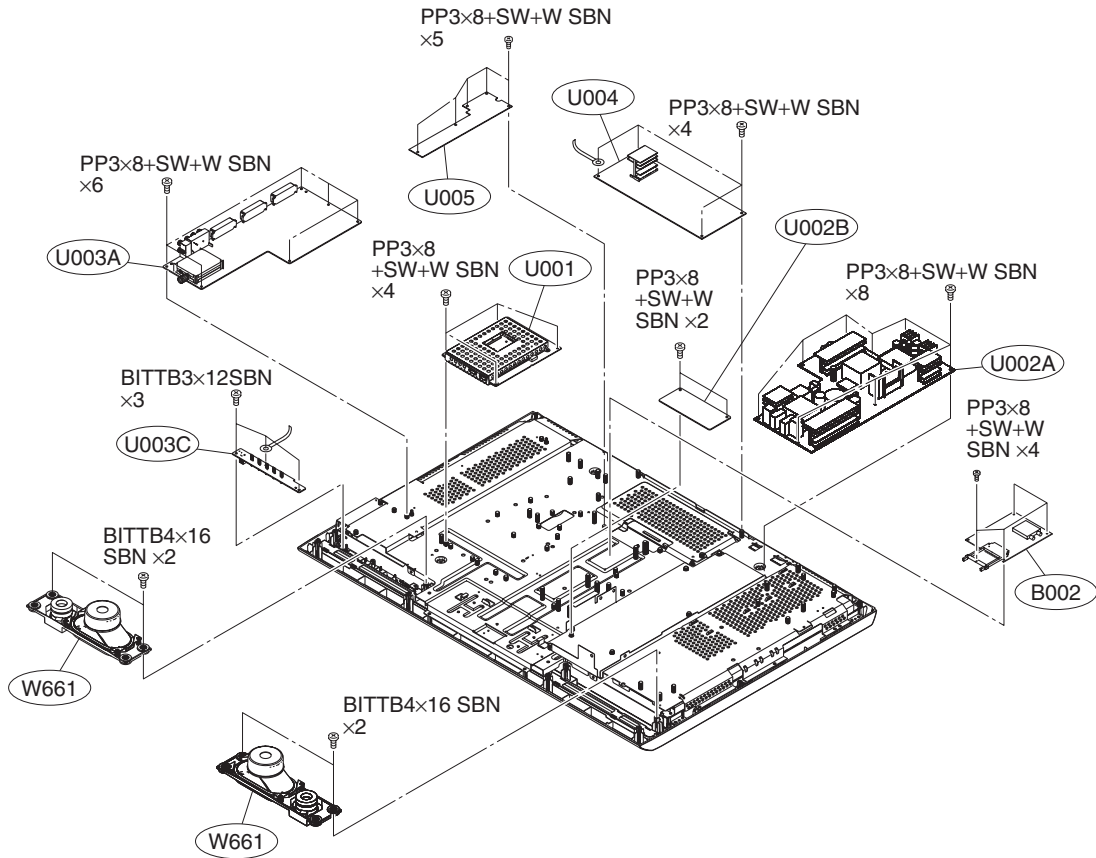

4. Remove the display.

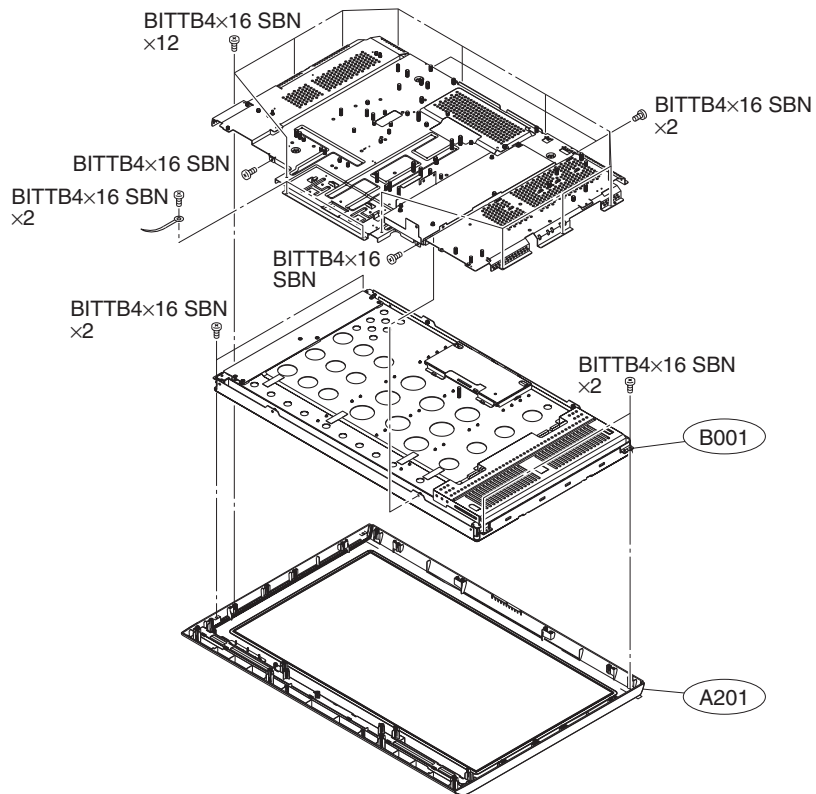

EXPLODED VIEWS (Representative of 32WLT58)

1. Chassis Block

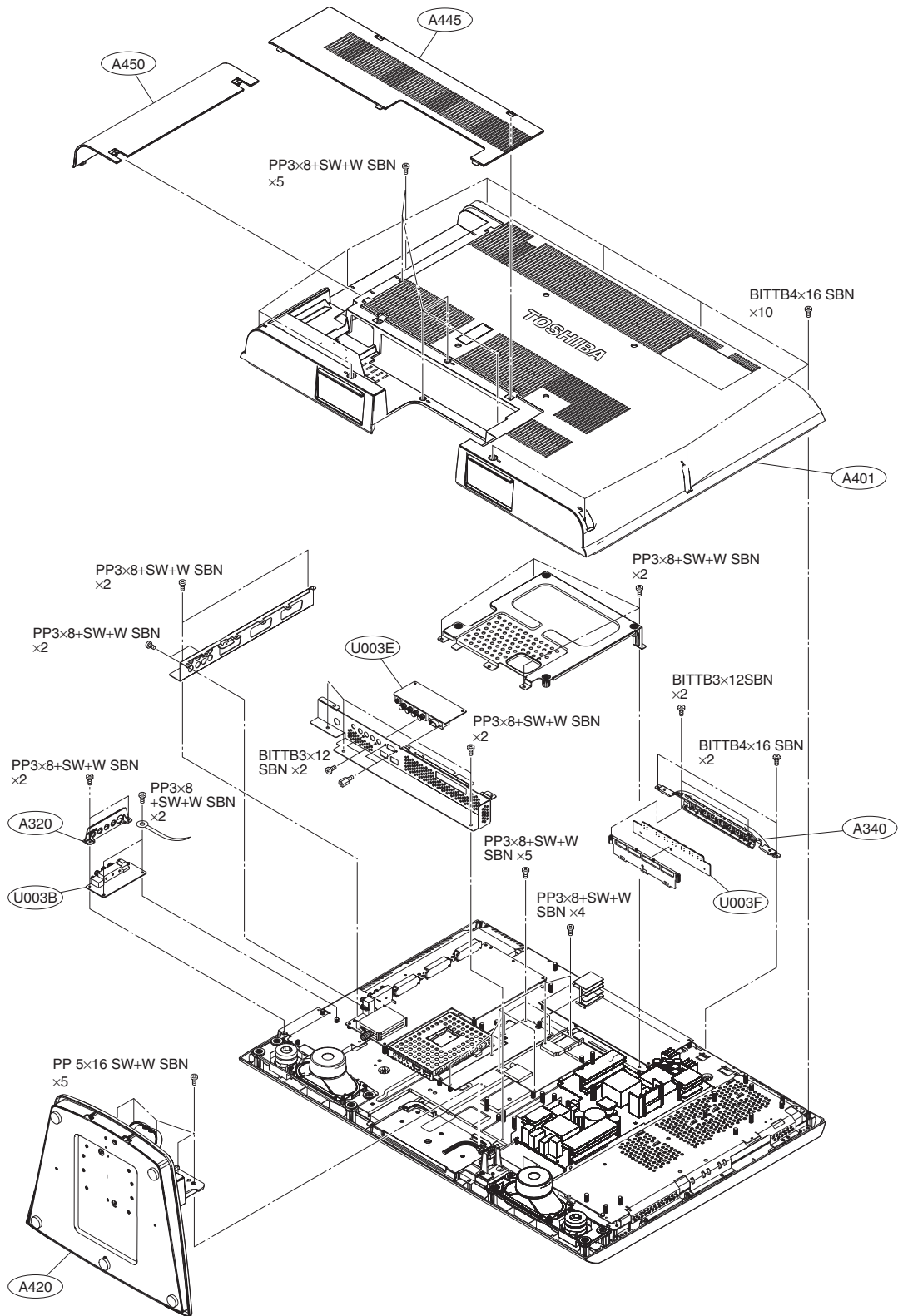

2. Main Block

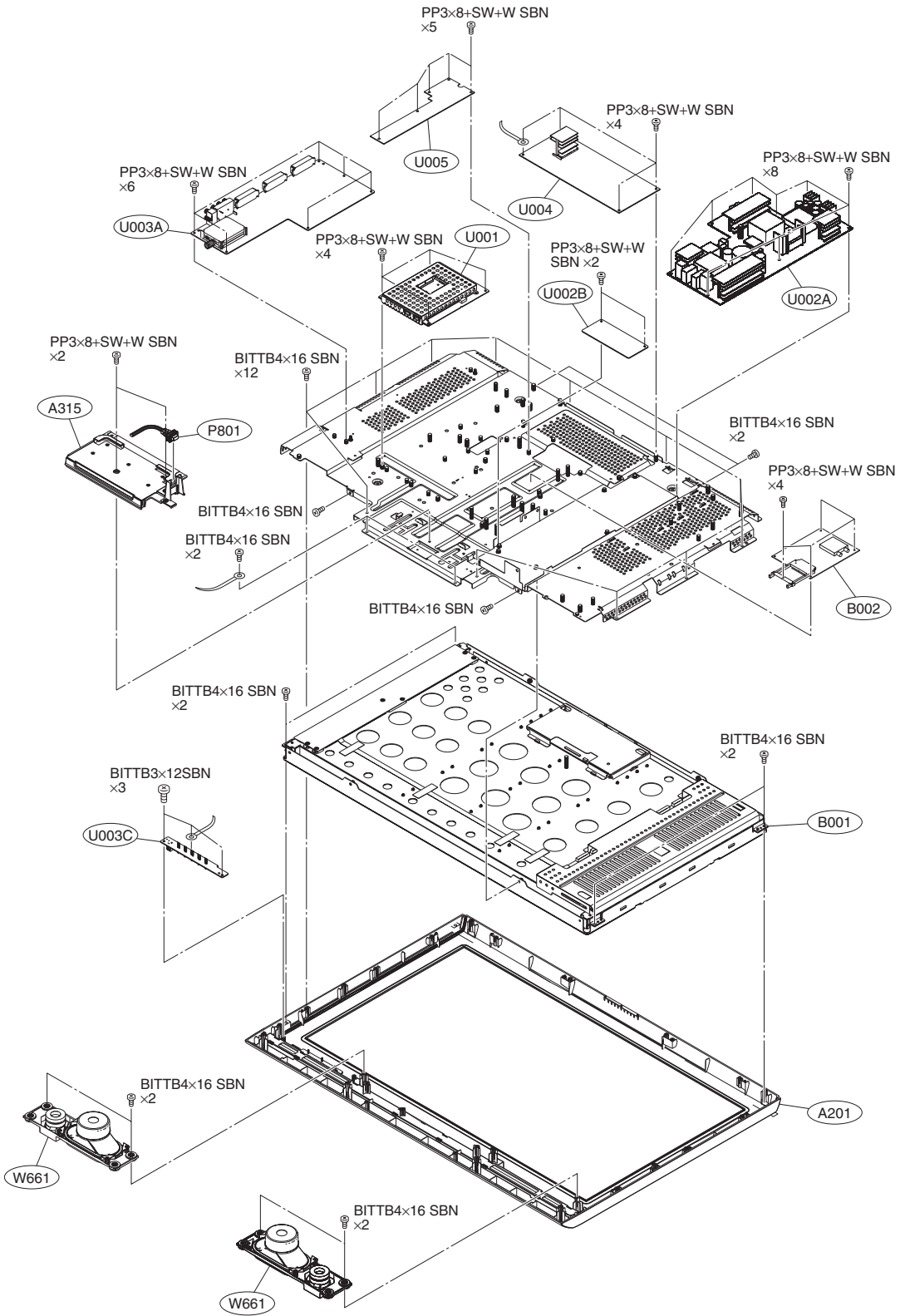

PACKING DISASSEMBLY

32WLT58

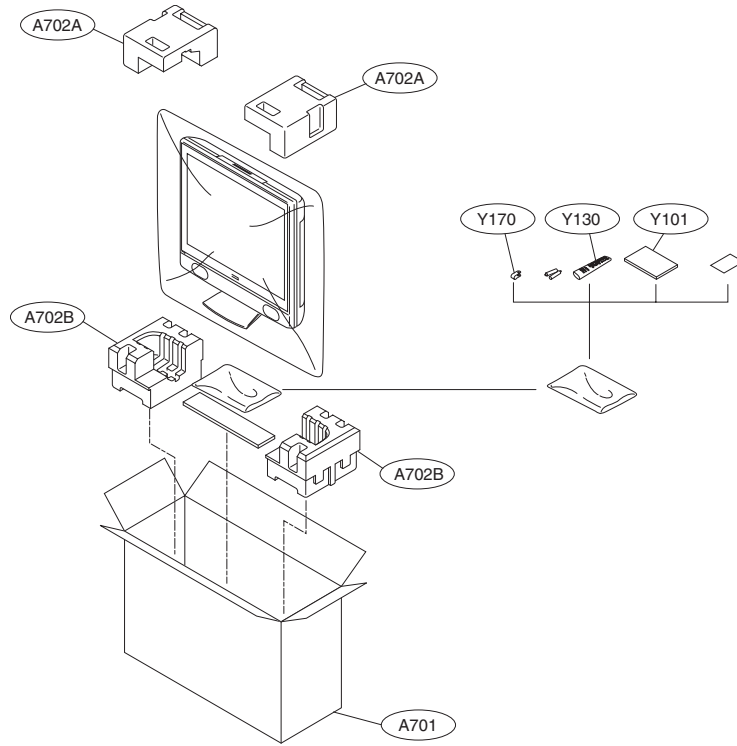

37WLT58

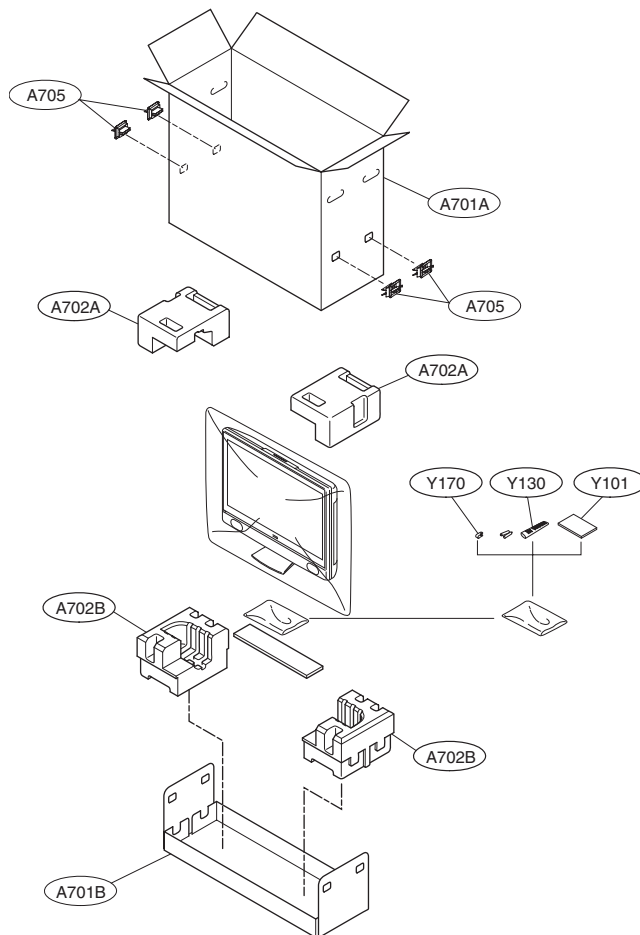

CHASSIS AND CABINET REPLACEMENT PARTS LIST

WARNING: BEFORE SERVICING THIS CHASSIS, READ THE "SERVICE SAFETY PRECAUTIONS" ON PAGE 3 OF THIS MANUAL.

CAUTION: The international hazard symbols " " in the schematic diagram and the parts list designate components which have special characteristics important for safety and should be replaced only with types identical to those in the original circuit or specified in the parts list. The mounting position of replacements is to be identical with originals. Before replacing any of these components, read carefully the PRODUCT SAFETY NOTICE. Do not degrade the safety of the receiver through improper servicing.

NOTICE:
The part number must be used when ordering parts, in order to assist in processing, be sure to include the Model number and Description.
The PC board assembly with* mark is no longer available after the end of the production.

Model : 32WLT58/37WLT58

Capacitors CD : Ceramic Disk PF : Plastic Film EL : Electrolytic
Resistors CF : Carbon Film CC : Carbon Composition MF : Metal Film
 OMF : Oxide Metal Film VR : Variable Resistor FR : Fusible Resistor
(All CD and PF capacitors are $\pm 5\%$, 50V and all resistors, $\pm 5\%$, 1/6W unless otherwise noted.)

Location No.	Parts No.	Description
#1 : [32WLT58]		
#2 : [37WLT58]		
CAPACITORS		
C101	76109103	CERAMIC CHIP, 50V B 0.01UF K
C102	76073019	ELECTROLYTIC, 10V 470UF M 3A
C103	76109102	CERAMIC CHIP, 50V B 1000PF K
C104	76619143	ELECTROLYTIC CHIP, 50V 4.7UF M
C105	76073019	ELECTROLYTIC, 10V 470UF M 3A
C113	76109102	CERAMIC CHIP, 50V B 1000PF K
C117	76109103	CERAMIC CHIP, 50V B 0.01UF K
C118	76109103	CERAMIC CHIP, 50V B 0.01UF K
C162	76105101	CERAMIC CHIP, 50V CH 100PF J
C164	76100103	CERAMIC CHIP, 50V F 0.01UF Z
C190	76092730	CERAMIC CHIP, 16V B 0.1UF K
C501	76100104	CERAMIC CHIP, 25V F 0.1UF Z
C502	76100104	CERAMIC CHIP, 25V F 0.1UF Z
C503	76619046	ELECTROLYTIC CHIP, 16V 470UF
C504	76109103	CERAMIC CHIP, 50V B 0.01UF K
C505	76619046	ELECTROLYTIC CHIP, 16V 470UF
C506	76109103	CERAMIC CHIP, 50V B 0.01UF K
C514	76665221	ELECTROLYTIC, 10V 220UF M 3A
C516	76105110	CERAMIC CHIP, 50V CH 11PF J
C517	76092785	CERAMIC CHIP, 10V B 0.47UF K
C519	76619048	ELECTROLYTIC CHIP, 25V 4.7UF M
C521	76092733	CERAMIC CHIP, 50V B 0.022UF K
C524	76109103	CERAMIC CHIP, 50V B 0.01UF K
C526	76109103	CERAMIC CHIP, 50V B 0.01UF K
C527	76619071	ELECTROLYTIC CHIP, 50V 2.2UF
C529	76100104	CERAMIC CHIP, 25V F 0.1UF Z
C530	76619157	ELECTROLYTIC CHIP, 16V 100UF
C605	76109102	CERAMIC CHIP, 50V B 1000PF K
C606	76109102	CERAMIC CHIP, 50V B 1000PF K
C612	76664102	ELECTROLYTIC, 6.3V 1000UF M 3A
C631	76619102	ELECTROLYTIC CHIP, 16V 47UF M
C632	76092731	CERAMIC CHIP, 16V B 1UF K
C651	76092463	CERAMIC CHIP, 16V B 0.22UF K
C652	76092463	CERAMIC CHIP, 16V B 0.22UF K
C653	76092538	ELECTROLYTIC CHIP, 10V F 1UF Z
C655	76109103	CERAMIC CHIP, 50V B 0.01UF K
C661	76109102	CERAMIC CHIP, 50V B 1000PF K
C662	76109102	CERAMIC CHIP, 50V B 1000PF K
C663	76619100	ELECTROLYTIC CHIP, 16V 10UF M
C665	76669479	ELECTROLYTIC, 50V 4.7UF M
C666	76669479	ELECTROLYTIC, 50V 4.7UF M
C671	76669100	ELECTROLYTIC, 50V 10UF M

Location No.	Parts No.	Description
C674	76669100	ELECTROLYTIC, 50V 10UF M
C677	76109681	CERAMIC CHIP, 50V B 680PF K
C678	76109681	CERAMIC CHIP, 50V B 680PF K
C680	76668102	ELECTROLYTIC, 35V 1000UF M 3A
C681	76668102	ELECTROLYTIC, 35V 1000UF M 3A
C682	76668102	ELECTROLYTIC, 35V 1000UF M 3A
C690	76815103	CERAMIC CHIP, 50V B 0.01UF K
C694	76285104	CERAMIC CHIP, 50V B 0.1UF K
C696	76285104	CERAMIC CHIP, 50V B 0.1UF K
△ C801	76168007	MT PLA AC275V 1UF M
△ C802	76503508	MT PLA PCX2 337 11474
△ C806	76092555	CERAMIC DISC, AC250V E 1000PF M
△ C807	76092555	CERAMIC DISC, AC250V E 1000PF M
△ C808	76092553	CERAMIC DISC, AC250V B 470PF K
△ C809	76092553	CERAMIC DISC, AC250V B 470PF K
C812	76109102	CERAMIC CHIP, 50V B 1000PF K
C814	76109102	CERAMIC CHIP, 50V B 1000PF K
C815	76073037	ELECTROLYTIC, 16V 47UF M 3A
C815A	23960136	ADHESIVE, SILICONE, TSE3843-W
C816	76109102	CERAMIC CHIP, 50V B 1000PF K
C817	76109102	CERAMIC CHIP, 50V B 1000PF K
C818	76669010	ELECTROLYTIC, 50V 1UF M
C819	76539684	PLASTIC FILM, 50V 0.68UF J
C820	76125010	CHEMICON CE69R 450V 270UF M 3H
C821	76125011	CHEMICON CE04R 450V 82UF M 4A
C822	76214103	CERAMIC DISC, 500V B 0.01UF K
C824	76168008	MT PLA 450V 1UF K
C825	76168008	MT PLA 450V 1UF K
C826	76092339	CERAMIC DISC, 2KV 330PF K
C827	76092339	CERAMIC DISC, 2KV 330PF K
C840	76125009	CHEMICON 450V 47UF M
C843	76166001	CERAMIC DISK CC45 SL 3.15KV 47PF J
C844	76669479	ELECTROLYTIC, 50V 4.7UF M
C845	76073196	ELECTROLYTIC, 50V 22UF M 3A
C846	76073140	ELECTROLYTIC CE04P 10V 680UF M 3A
C847	76665471	ELECTROLYTIC, 10V 470UF M
C848	76214471	CERAMIC DISC, 500V B 470PF K
C849A	23960136	ADHESIVE, SILICONE, TSE3843-W
C860	76214103	CERAMIC DISC, 500V B 0.01UF K
C861	76503053	PLASTIC FILM, 63V 1UF J
C862	76669229	ELECTROLYTIC, 50V 2.2UF M
C863	76503049	PLASTIC FILM, 63V 0.47UF J
C864	76567224	PLASTIC FILM, 50V 0.22UF J
C865	76567224	PLASTIC FILM, 50V 0.22UF J
C866	76092341	CERAMIC DISC, 2KV R 470PF K
C868	76435221	CERAMIC DISC, 500V SL 220PF J

Location No.	Parts No.	Description
C869	76435221	CERAMIC DISC, 500V SL 220PF J
△ C870	76503425	PLASTIC FILM CQ92 3D2J473J-K5
C872	76073189	ELECTROLYTIC, 35V 1000UF M
C873	76073189	ELECTROLYTIC, 35V 1000UF M
C876	76073204	ELECTROLYTIC CE04P 50V 330UF M 3A
C877	76669229	ELECTROLYTIC, 50V 2.2UF M
C878	76503041	PLASTIC FILM, 63V 0.1UF J
C880	76503229	PLASTIC FILM, 1250VH 1000PF H
C881	76092337	CERAMIC DISC, 2KV 220PF K
C882	76567334	PLASTIC FILM, 50V 0.33UF J
C883	76212221	CERAMIC DISC, 50V B 220PF K
C884	76073196	ELECTROLYTIC, 50V 22UF M 3A
C885	76214471	CERAMIC DISC, 500V B 470PF K
C886	76212152	CERAMIC DISC, 50V B 1500PF K
C887	76214471	CERAMIC DISC, 500V B 470PF K
C888	76073189	ELECTROLYTIC, 35V 1000UF M
C889	76073189	ELECTROLYTIC, 35V 1000UF M
C890	76796102	ELECTROLYTIC, 35V 1000UF M
C891	76214471	CERAMIC DISC, 500V B 470PF K
C892	76676100	ELECTROLYTIC, 100V 10UF M 3A
C893	76747220	ELECTROLYTIC, 50V 22UF M 7L 3A
C894	76214471	CERAMIC DISC, 500V B 470PF K
C895	76073188	ELECTROLYTIC, 35V 680UF M
C896	76073188	ELECTROLYTIC, 35V 680UF M
C897	76796102	ELECTROLYTIC, 35V 1000UF M
C898	76669010	ELECTROLYTIC, 50V 1UF M
C8171	76092730	CERAMIC CHIP, 16V B 0.1UF K
C8191	76092730	CERAMIC CHIP, 16V B 0.1UF K
C8210	76105331	CERAMIC CHIP, 50V CH 330PF J
C8211	76815473	CERAMIC CHIP, 50V B 0.047UF K
C8212	76092178	CERAMIC CHIP, 25V B 0.1UF K
C8213	76109102	CERAMIC CHIP, 50V B 1000PF K
C8241	76073196	ELECTROLYTIC, 50V 22UF M 3A
C8250	76092341	CERAMIC DISC, 2KV R 470PF K
C8251	76434100	CERAMIC DISC, 500V SL 10PF D
C8390	76109102	CERAMIC CHIP, 50V B 1000PF K
C8401	76092733	CERAMIC CHIP, 50V B 0.022UF K
C8402	76092733	CERAMIC CHIP, 50V B 0.022UF K
C8403	76669470	ELECTROLYTIC, 50V 47UF M
C8490	76669010	ELECTROLYTIC, 50V 1UF M
C8601	76591682	PLASTIC FILM, 50V 6800PF J
C8602	76212101	CERAMIC DISC, 50V B 100PF K
C8605	76285104	CERAMIC CHIP, 50V B 0.1UF K
C8701	76567224	PLASTIC FILM, 50V 0.22UF J
C8702	76287224	CHIP CER 50V F 224Z GRM319F11H224ZA01D
C8703	76109102	CERAMIC CHIP, 50V B 1000PF K
C8801	76092730	CERAMIC CHIP, 16V B 0.1UF K
C8802	76092883	CERAMIC CHIP, 50V B 0.1UF K
C8891	76503049	PLASTIC FILM, 63V 0.47UF J
CB01	76202221	ELECTROLYTIC, 10V 220UF M 7L 3A
CB02	76202221	ELECTROLYTIC, 10V 220UF M 7L 3A
CB03	76100104	CERAMIC CHIP, 25V F 0.1UF Z
CB04	76100104	CERAMIC CHIP, 25V F 0.1UF Z
CB05	76202221	ELECTROLYTIC, 10V 220UF M 7L 3A
CB38	76100104	CERAMIC CHIP, 25V F 0.1UF Z
CC01	76105100	CERAMIC CHIP, 50V CH 10PF D
CC02	76105100	CERAMIC CHIP, 50V CH 10PF D
CC03	76105100	CERAMIC CHIP, 50V CH 10PF D
CC04	76105100	CERAMIC CHIP, 50V CH 10PF D
CC05	76105100	CERAMIC CHIP, 50V CH 10PF D
CC06	76105100	CERAMIC CHIP, 50V CH 10PF D
CC07	76105100	CERAMIC CHIP, 50V CH 10PF D
CC08	76105100	CERAMIC CHIP, 50V CH 10PF D
CC09	76105100	CERAMIC CHIP, 50V CH 10PF D
CC10	76105100	CERAMIC CHIP, 50V CH 10PF D
CC11	76109102	CERAMIC CHIP, 50V B 1000PF K
CC12	76109102	CERAMIC CHIP, 50V B 1000PF K
CC14	76109102	CERAMIC CHIP, 50V B 1000PF K
CC15	76109102	CERAMIC CHIP, 50V B 1000PF K
CC16	76109102	CERAMIC CHIP, 50V B 1000PF K
CC17	76109102	CERAMIC CHIP, 50V B 1000PF K
CC21	76109102	CERAMIC CHIP, 50V B 1000PF K
CC31	76105100	CERAMIC CHIP, 50V CH 10PF D
	76109472	CERAMIC CHIP, 50V B 4700PF K
CC32	76105100	CERAMIC CHIP, 50V CH 10PF D
CC33	76109102	CERAMIC CHIP, 50V B 1000PF K

Location No.	Parts No.	Description
CC40	76109102	CERAMIC CHIP, 50V B 1000PF K
CC41	76109102	CERAMIC CHIP, 50V B 1000PF K
CC59	76109102	CERAMIC CHIP, 50V B 1000PF K
CC60	76109102	CERAMIC CHIP, 50V B 1000PF K
CC61	76109102	CERAMIC CHIP, 50V B 1000PF K
CC62	76109102	CERAMIC CHIP, 50V B 1000PF K
CC63	76109102	CERAMIC CHIP, 50V B 1000PF K
CC64	76109102	CERAMIC CHIP, 50V B 1000PF K
CC65	76109102	CERAMIC CHIP, 50V B 1000PF K
CC66	76109102	CERAMIC CHIP, 50V B 1000PF K
CC67	76109102	CERAMIC CHIP, 50V B 1000PF K
CC68	76109102	CERAMIC CHIP, 50V B 1000PF K
CC69	76109102	CERAMIC CHIP, 50V B 1000PF K
CC70	76109102	CERAMIC CHIP, 50V B 1000PF K
CC74	76109102	CERAMIC CHIP, 50V B 1000PF K
CC75	76109102	CERAMIC CHIP, 50V B 1000PF K
CC79	76109102	CERAMIC CHIP, 50V B 1000PF K
CC82	76109102	CERAMIC CHIP, 50V B 1000PF K
CD80	76666470	ELECTROLYTIC, 16V 47UF M 3A
CD82	76669100	ELECTROLYTIC, 50V 10UF M
CD83	76109103	CERAMIC CHIP, 50V B 0.01UF K
CD84	76109103	CERAMIC CHIP, 50V B 0.01UF K
CD85	76109103	CERAMIC CHIP, 50V B 0.01UF K
CD86	76109103	CERAMIC CHIP, 50V B 0.01UF K
CD87	76109103	CERAMIC CHIP, 50V B 0.01UF K
CD230	76109103	CERAMIC CHIP, 50V B 0.01UF K
CD233	76092628	CERAMIC CHIP, 6.3V B 10UF K
CD234	76092573	CERAMIC CHIP, 16V B 0.47UF K
CD235	76100104	CERAMIC CHIP, 25V F 0.1UF Z
CE10	76666470	ELECTROLYTIC, 16V 47UF M 3A
CE11	76539474	PLASTIC FILM, 50V 0.47UF J
CE12	76666470	ELECTROLYTIC, 16V 47UF M 3A
CE30	76073186	ELECTROLYTIC, 35V 470UF M
CE31	76125012	ELECTROLYTIC 04CQ 25V 2700UF M A
CE32	76073007	ELECTROLYTIC, 6.3V 3300UF M 3A
CE33	76539104	PLASTIC FILM, 50V 0.1UF J
CE34	76539104	PLASTIC FILM, 50V 0.1UF J
CE35	76539334	PLASTIC FILM, 50V 0.33UF J
CE36	76666470	ELECTROLYTIC, 16V 47UF M 3A
CE60	76073186	ELECTROLYTIC, 35V 470UF M
CE61	76617028	ELECTROLYTIC, 16V 1200UF M
CE62	76073020	ELECTROLYTIC, 10V 1000UF M 3A
CE63	76539104	PLASTIC FILM, 50V 0.1UF J
CE64	76539104	PLASTIC FILM, 50V 0.1UF J
CE65	76666470	ELECTROLYTIC, 16V 47UF M 3A
CE66	76539474	PLASTIC FILM, 50V 0.47UF J
CE67	76666470	ELECTROLYTIC, 16V 47UF M 3A
CE90	76073186	ELECTROLYTIC, 35V 470UF M
CE91	76617028	ELECTROLYTIC, 16V 1200UF M
CE92	76666471	ELECTROLYTIC, 16V 470UF M
CE93	76539104	PLASTIC FILM, 50V 0.1UF J
CE94	76539104	PLASTIC FILM, 50V 0.1UF J
CE95	76668101	ELECTROLYTIC, 35V 100UF M 3A
CR01	76092730	CERAMIC CHIP, 16V B 0.1UF K
CR02	76100104	CERAMIC CHIP, 25V F 0.1UF Z
CR03	76619157	ELECTROLYTIC CHIP, 16V 100UF
CR26	76100104	CERAMIC CHIP, 25V F 0.1UF Z
CR27	76619157	ELECTROLYTIC CHIP, 16V 100UF
CS01	76092731	CERAMIC CHIP, 16V B 1UF K
CS02	76092515	CERAMIC CHIP, 16V F 4.7UF Z
CS03	76092726	CERAMIC CHIP, 10V B 2.2UF K
CS04	76092726	CERAMIC CHIP, 10V B 2.2UF K
CS05	76092726	CERAMIC CHIP, 10V B 2.2UF K
CS06	76092726	CERAMIC CHIP, 10V B 2.2UF K
CS08	76092611	CERAMIC CHIP, 6.3V B 2.2UF K
CS09	76092611	CERAMIC CHIP, 6.3V B 2.2UF K
CS10	76092628	CERAMIC CHIP, 6.3V B 10UF K
CS11	76092628	CERAMIC CHIP, 6.3V B 10UF K
CS12	76109473	CERAMIC CHIP, 25V B 0.047UF K
CS13	76092628	CERAMIC CHIP, 6.3V B 10UF K
CS14	76092628	CERAMIC CHIP, 6.3V B 10UF K
CS15	76092628	CERAMIC CHIP, 6.3V B 10UF K
CS16	76092628	CERAMIC CHIP, 6.3V B 10UF K
CS26	76619100	ELECTROLYTIC CHIP, 16V 10UF M
CS31	76092611	CERAMIC CHIP, 6.3V B 2.2UF K
CS32	76092611	CERAMIC CHIP, 6.3V B 2.2UF K

Location No.	Parts No.	Description
CS33	76092611	CERAMIC CHIP, 6.3V B 2.2UF K
CS34	76092731	CERAMIC CHIP, 16V B 1UF K
CS39	76092573	CERAMIC CHIP, 16V B 0.47UF K
CS40	76092611	CERAMIC CHIP, 6.3V B 2.2UF K
CS41	76092611	CERAMIC CHIP, 6.3V B 2.2UF K
CS42	76092611	CERAMIC CHIP, 6.3V B 2.2UF K
CS43	76092611	CERAMIC CHIP, 6.3V B 2.2UF K
CS44	76092611	CERAMIC CHIP, 6.3V B 2.2UF K
CS45	76092611	CERAMIC CHIP, 6.3V B 2.2UF K
CS46	76092611	CERAMIC CHIP, 6.3V B 2.2UF K
CS47	76092611	CERAMIC CHIP, 6.3V B 2.2UF K
CS48	76092611	CERAMIC CHIP, 6.3V B 2.2UF K
CS49	76092611	CERAMIC CHIP, 6.3V B 2.2UF K
CS50	76092611	CERAMIC CHIP, 6.3V B 2.2UF K
CS51	76092611	CERAMIC CHIP, 6.3V B 2.2UF K
CS52	76092611	CERAMIC CHIP, 6.3V B 2.2UF K
CS53	76092611	CERAMIC CHIP, 6.3V B 2.2UF K
CS54	76092611	CERAMIC CHIP, 6.3V B 2.2UF K
CS55	76092611	CERAMIC CHIP, 6.3V B 2.2UF K
CS56	76092611	CERAMIC CHIP, 6.3V B 2.2UF K
CS57	76619102	ELECTROLYTIC CHIP, 16V 47UF M
CS62	76092611	CERAMIC CHIP, 6.3V B 2.2UF K
CS64	76619101	ELECTROLYTIC CHIP, 16V 22UF M
CS82	76092609	CERAMIC CHIP, 10V B 4.7UF K
CS83	76092609	CERAMIC CHIP, 10V B 4.7UF K
CS85	76092611	CERAMIC CHIP, 6.3V B 2.2UF K
CS86	76092611	CERAMIC CHIP, 6.3V B 2.2UF K
CS88	76092609	CERAMIC CHIP, 10V B 4.7UF K
CS89	76105101	CERAMIC CHIP, 50V CH 100PF J
CS90	76092609	CERAMIC CHIP, 10V B 4.7UF K
CS91	76105101	CERAMIC CHIP, 50V CH 100PF J
CS93	76092515	CERAMIC CHIP, 16V F 4.7UF Z
CT01	76092790	CERAMIC CHIP CK732B 6.3V 10UF K
CT04	76105151	CERAMIC CHIP, 50V CH 150PF J
CT05	76092790	CERAMIC CHIP CK732B 6.3V 10UF K
CT06	76092790	CERAMIC CHIP CK732B 6.3V 10UF K
CT07	76092790	CERAMIC CHIP CK732B 6.3V 10UF K
CT08	76100104	CERAMIC CHIP, 25V F 0.1UF Z
CT09	76109103	CERAMIC CHIP, 50V B 0.01UF K
CV01	76666471	ELECTROLYTIC, 16V 470UF M
CV02	76100104	CERAMIC CHIP, 25V F 0.1UF Z
CV03	76100104	CERAMIC CHIP, 25V F 0.1UF Z
CV04	76100104	CERAMIC CHIP, 25V F 0.1UF Z
CV12	76092731	CERAMIC CHIP, 16V B 1UF K
CV13	76092731	CERAMIC CHIP, 16V B 1UF K
CV14	76092731	CERAMIC CHIP, 16V B 1UF K
CV15	76100104	CERAMIC CHIP, 25V F 0.1UF Z
CV16	76092731	CERAMIC CHIP, 16V B 1UF K
CV17	76092731	CERAMIC CHIP, 16V B 1UF K
CV18	76100104	CERAMIC CHIP, 25V F 0.1UF Z
CV19	76092731	CERAMIC CHIP, 16V B 1UF K
CV20	76092731	CERAMIC CHIP, 16V B 1UF K
CV21	76092731	CERAMIC CHIP, 16V B 1UF K
CV22	76092731	CERAMIC CHIP, 16V B 1UF K
CV23	76092731	CERAMIC CHIP, 16V B 1UF K
CV24	76092731	CERAMIC CHIP, 16V B 1UF K
CV25	76092731	CERAMIC CHIP, 16V B 1UF K
CV26	76092731	CERAMIC CHIP, 16V B 1UF K
CV27	76092731	CERAMIC CHIP, 16V B 1UF K
CV28	76092731	CERAMIC CHIP, 16V B 1UF K
CV29	76092731	CERAMIC CHIP, 16V B 1UF K
CV33	76100104	CERAMIC CHIP, 25V F 0.1UF Z
CV34	76100104	CERAMIC CHIP, 25V F 0.1UF Z
CV35	76619157	ELECTROLYTIC CHIP, 16V 100UF
CV36	76100104	CERAMIC CHIP, 25V F 0.1UF Z
CV40	76100104	CERAMIC CHIP, 25V F 0.1UF Z
CV41	76100104	CERAMIC CHIP, 25V F 0.1UF Z
CV50	76619102	ELECTROLYTIC CHIP, 16V 47UF M
CV51	76619102	ELECTROLYTIC CHIP, 16V 47UF M
CV52	76619102	ELECTROLYTIC CHIP, 16V 47UF M
CV53	76100104	CERAMIC CHIP, 25V F 0.1UF Z
CV54	76100104	CERAMIC CHIP, 25V F 0.1UF Z
CV55	76100104	CERAMIC CHIP, 25V F 0.1UF Z
CV56	76619157	ELECTROLYTIC CHIP, 16V 100UF
CV57	76619157	ELECTROLYTIC CHIP, 16V 100UF
CV58	76619157	ELECTROLYTIC CHIP, 16V 100UF

Location No.	Parts No.	Description
CV59	76666471	ELECTROLYTIC, 16V 470UF M
CV60	76666471	ELECTROLYTIC, 16V 470UF M
CV61	76666471	ELECTROLYTIC, 16V 470UF M
CV62	76100104	CERAMIC CHIP, 25V F 0.1UF Z
CV63	76666471	ELECTROLYTIC, 16V 470UF M
CV72	76619101	ELECTROLYTIC CHIP, 16V 22UF M
CV121	76109103	CERAMIC CHIP, 50V B 0.01UF K
CV122	76105101	CERAMIC CHIP, 50V CH 100PF J
CY01	76100104	CERAMIC CHIP, 25V F 0.1UF Z
CY02	76100104	CERAMIC CHIP, 25V F 0.1UF Z
CY03	76100104	CERAMIC CHIP, 25V F 0.1UF Z
CY650	76109103	CERAMIC CHIP, 50V B 0.01UF K
RESISTORS		
R103	76011101	CHIP, 1/20W 100 OHM J
R104	76011103	CHIP, 1/20W 10K OHM J
R105	76011273	CHIP, 1/20W 27K OHM J
R107	76000445	CHIP JUMPER, 1608TYPE
R108	76000445	CHIP JUMPER, 1608TYPE
R114	76000445	CHIP JUMPER, 1608TYPE
R167	76011101	CHIP, 1/20W 100 OHM J
R169	76000445	CHIP JUMPER, 1608TYPE
R170	76011682	CHIP, 1/20W 6.8K OHM J
R501	76011682	CHIP, 1/20W 6.8K OHM J
R502	76011272	CHIP, 1/20W 2.7K OHM J
R504	76011101	CHIP, 1/20W 100 OHM J
R505	76011101	CHIP, 1/20W 100 OHM J
R506	76011273	CHIP, 1/20W 27K OHM J
R507	76011392	CHIP, 1/20W 3.9K OHM J
R508	76011682	CHIP, 1/20W 6.8K OHM J
R512	76011101	CHIP, 1/20W 100 OHM J
R514	76011102	CHIP, 1/20W 1K OHM J
R607	76011223	CHIP, 1/20W 22K OHM J
R617	76011104	CHIP, 1/20W 100K OHM J
R620	76011223	CHIP, 1/20W 22K OHM J
R621	76011472	CHIP, 1/20W 4.7K OHM J
R650	76011102	CHIP, 1/20W 1K OHM J
R651	76011473	CHIP, 1/20W 47K OHM J
R652	76011103	CHIP, 1/20W 10K OHM J
R653	76011223	CHIP, 1/20W 22K OHM J
R654	76011103	CHIP, 1/20W 10K OHM J
R655	76011222	CHIP, 1/20W 2.2K OHM J
R664	76011104	CHIP, 1/20W 100K OHM J
R665	76011104	CHIP, 1/20W 100K OHM J
R667	76011104	CHIP, 1/20W 100K OHM J
R670	76011472	CHIP, 1/20W 4.7K OHM J
R671	76011182	CHIP, 1/20W 1.8K OHM J
R672	76011472	CHIP, 1/20W 4.7K OHM J
R673	76011182	CHIP, 1/20W 1.8K OHM J
R675	76011102	CHIP, 1/20W 1K OHM J
R676	76011473	CHIP, 1/20W 47K OHM J
R677	76011473	CHIP, 1/20W 47K OHM J
R684	76871229	CHIP, 1/8W 2.2 OHM J
R685	76871229	CHIP, 1/8W 2.2 OHM J
R687	76871102	CHIP, 1/8W 1K OHM J
R688	76871102	CHIP, 1/8W 1K OHM J
R689	76871102	CHIP, 1/8W 1K OHM J
R695	76871102	CHIP, 1/8W 1K OHM J
R696	76871102	CHIP, 1/8W 1K OHM J
R697	76000576	CHIP JUMPER, 3216TYPE
R698	76871102	CHIP, 1/8W 1K OHM J
△ R801	76017004	METAL GLAZE 1/2W 510K J
△ R809	76004718	METAL GLAZE, 1/2W 8.2M OHM J
R812	76011473	CHIP, 1/20W 47K OHM J
R820	76019461	METAL PLATE, 2W 0.15 OHM J
△ R821	76019461	METAL PLATE, 2W 0.15 OHM J
R826	76004714	METAL GLAZE, 1/2W 1.2M OHM J
△ R830	76007061	CERAMIC COVERED, 2W 1.8 OHM K
R831	76120003	CERAMIC COVERED G 5W 4.7 J
R840	76382823	OXIDE FILM 1W 82K J
R841	76322339	METAL FILM 1W 3R3 J
R842	76310479	OXIDE METAL FILM, 1/2W 4.7 OHM J
R860	76552271	OXIDE METAL FILM, 1/2W 270 OHM J
R862	76552681	OXIDE METAL FILM, 1/2W 680 OHM J
R863	76011272	CHIP, 1/20W 2.7K OHM J
R864	76552101	OXIDE METAL FILM, 1/2W 100 OHM J

Location No.	Parts No.	Description
R865	76552100	OXIDE METAL FILM, 1/2W 10 OHM J
R867	76552330	OXIDE METAL FILM, 1/2W 33 OHM J
R880	76553683	OXIDE METAL FILM, 1W 68K OHM J
R881	76553683	OXIDE METAL FILM, 1W 68K OHM J
R882	76323569	METAL FILM 2W 5R6 J
R883	76079010	METAL RES 2W R47 J
R884	76321339	OXIDE METAL FILM, 1/2W 3.3 OHM J
R885	76553101	OXIDE METAL FILM, 1W 100 OHM J
R886	76554432	OXIDE FILM 2W 4.3K J
R4100	76011102	CHIP, 1/20W 1K OHM J
R4101	76011681	CHIP, 1/20W 680 OHM J
R4102	76011471	CHIP, 1/20W 470 OHM J
R4103	76011102	CHIP, 1/20W 1K OHM J
R4104	76011152	CHIP, 1/20W 1.5K OHM J
R4105	76011102	CHIP, 1/20W 1K OHM J
R4106	76011681	CHIP, 1/20W 680 OHM J
R4107	76011471	CHIP, 1/20W 470 OHM J
R4108	76011102	CHIP, 1/20W 1K OHM J
R4109	76011152	CHIP, 1/20W 1.5K OHM J
R4120	76000445	CHIP JUMPER, 1608TYPE
R4122	76000445	CHIP JUMPER, 1608TYPE
R6603	76011223	CHIP, 1/20W 22K OHM J
R6605	76011103	CHIP, 1/20W 10K OHM J
R6606	76011104	CHIP, 1/20W 100K OHM J
R6607	76011102	CHIP, 1/20W 1K OHM J
R8110	76000250	METAL FILM, 1/4W 56K OHM F
R8111	76000250	METAL FILM, 1/4W 56K OHM F
R8112	76000250	METAL FILM, 1/4W 56K OHM F
R8113	76000250	METAL FILM, 1/4W 56K OHM F
R8114	76000527	METAL FILM, 1/4W 5.6K OHM F
R8115	76000639	METAL FILM, 1/4W 22K OHM F
R8116	76000554	CHIP 1/16W 510 F
R8117	76000574	METAL FILM CHIP 1/16W 2.7K F
R8118	76000574	METAL FILM CHIP 1/16W 2.7K F
R8130	76871182	CHIP, 1/8W 1.8K OHM J
R8131	76871182	CHIP, 1/8W 1.8K OHM J
R8132	76871182	CHIP, 1/8W 1.8K OHM J
R8133	76011102	CHIP, 1/20W 1K OHM J
R8140	76011682	CHIP, 1/20W 6.8K OHM J
R8141	76011473	CHIP, 1/20W 47K OHM J
R8142	76872470	CHIP, 1/16W 47 OHM J
R8143	76872470	CHIP, 1/16W 47 OHM J
R8144	76872390	CHIP, 1/16W 39 OHM J
R8150	76011562	CHIP, 1/20W 5.6K OHM J
R8151	76011222	CHIP, 1/20W 2.2K OHM J
R8152	76011473	CHIP, 1/20W 47K OHM J
R8160	76011103	CHIP, 1/20W 10K OHM J
R8161	76011473	CHIP, 1/20W 47K OHM J
R8162	76011103	CHIP, 1/20W 10K OHM J
R8191	76000445	CHIP JUMPER, 1608TYPE
R8192	76011471	CHIP, 1/20W 470 OHM J
R8193	76011102	CHIP, 1/20W 1K OHM J
R8194	76011151	CHIP, 1/20W 150 OHM J
R8195	76011151	CHIP, 1/20W 150 OHM J
R8210	76998471	CHIP, 1/16W 470 OHM
R8212	76998102	CHIP, 1/16W 1K OHM
R8213	76011222	CHIP, 1/20W 2.2K OHM J
R8214	76000445	CHIP JUMPER, 1608TYPE
R8215	76998222	CHIP, 1/16W 2.2K OHM
R8216	76998222	CHIP, 1/16W 2.2K OHM
R8217	76011229	CHIP, 1/16W 2.2 OHM J
R8218	76998152	CHIP, 1/16W 1.5K OHM D
R8230	76872332	CHIP, 1/16W 3.3K OHM J
R8231	76011223	CHIP, 1/20W 22K OHM J
R8232	76011472	CHIP, 1/20W 4.7K OHM J
R8233	76011473	CHIP, 1/20W 47K OHM J
R8240	76190015	CHIP RES 1/16W 473D
R8241	76190015	CHIP RES 1/16W 473D
R8242	76190015	CHIP RES 1/16W 473D
R8243	76190015	CHIP RES 1/16W 473D
R8244	76190015	CHIP RES 1/16W 473D
R8245	76190015	CHIP RES 1/16W 473D
R8246	76190015	CHIP RES 1/16W 473D
R8247	76190015	CHIP RES 1/16W 473D
R8248	76190015	CHIP RES 1/16W 473D
R8249	76000445	CHIP JUMPER, 1608TYPE

Location No.	Parts No.	Description
R8310	76011223	CHIP, 1/20W 22K OHM J
R8312	76011471	CHIP, 1/20W 470 OHM J
R8313	76011102	CHIP, 1/20W 1K OHM J
R8390	76011473	CHIP, 1/20W 47K OHM J
R8391	76011102	CHIP, 1/20W 1K OHM J
R8392	76011681	CHIP, 1/20W 680 OHM J
R8393	76011681	CHIP, 1/20W 680 OHM J
R8394	76011681	CHIP, 1/20W 680 OHM J
R8395	76011681	CHIP, 1/20W 680 OHM J
R8396	76011222	CHIP, 1/20W 2.2K OHM J
R8403	76011102	CHIP, 1/20W 1K OHM J
R8404	76011101	CHIP, 1/20W 100 OHM J
R8405	76011102	CHIP, 1/20W 1K OHM J
R8406	76011473	CHIP, 1/20W 47K OHM J
R8407	76000572	CHIP 1/16W 3.3K F
R8408	76000422	CHIP 1/16W 2.2K F
R8409	76011102	CHIP, 1/20W 1K OHM J
R8410	76000445	CHIP JUMPER, 1608TYPE
R8411	76321479	OXIDE METAL FILM, 1/2W 4.7 OHM J
R8412	76871822	CHIP, 1/8W 8.2K OHM J
R8601	76000247	METAL FILM, 1/4W 39K OHM F
R8602	76366472	CARBON FILM, 1/6W 4.7K OHM J
R8603	76011103	CHIP, 1/20W 10K OHM J
R8604	76011102	CHIP, 1/20W 1K OHM J
R8605	76011472	CHIP, 1/20W 4.7K OHM J
R8606	76011103	CHIP, 1/20W 10K OHM J
R8607	76872221	CHIP, 1/16W 220 OHM J
R8701	76000595	CHIP 1/16W 15K F
R8702	76190012	METAL FILM CHIP 1/16W 1.5K F
R8703	76011221	CHIP, 1/20W 220 OHM J
R8704	76000445	CHIP JUMPER, 1608TYPE
R8705	76011220	CHIP, 1/20W 22 OHM J
R8706	76011103	CHIP, 1/20W 10K OHM J
R8707	76011103	CHIP, 1/20W 10K OHM J
R8709	76011101	CHIP, 1/20W 100 OHM J
R8710	76011101	CHIP, 1/20W 100 OHM J
R8711	76011223	CHIP, 1/20W 22K OHM J
R8712	76011473	CHIP, 1/20W 47K OHM J
R8713	76011103	CHIP, 1/20W 10K OHM J
R8714	76011102	CHIP, 1/20W 1K OHM J
R8715	76011102	CHIP, 1/20W 1K OHM J
R8716	76011103	CHIP, 1/20W 10K OHM J
R8801	76011102	CHIP, 1/20W 1K OHM J
R8802	76011102	CHIP, 1/20W 1K OHM J
R8803	76366221	CARBON FILM, 1/6W 220 OHM J
R8804	76871222	CHIP, 1/8W 2.2K OHM J
R8805	76011102	CHIP, 1/20W 1K OHM J
R8806	76011102	CHIP, 1/20W 1K OHM J
R8807	76011152	CHIP, 1/20W 1.5K OHM J
R8808	76011101	CHIP, 1/20W 100 OHM J
R8809	76011223	CHIP, 1/20W 22K OHM J
R8810	76000605	CHIP, 1/16W 6.8K OHM F
R8811	76190012	METAL FILM CHIP 1/16W 1.5K F
R8812	76000446	CHIP 1/16W 220 F
R8813	76000824	CHIP JUMPER, 2125TYPE
R8814	76011103	CHIP, 1/20W 10K OHM J
R8815	76872151	CHIP, 1/16W 150 OHM J
RA711	76011683	CHIP, 1/20W 68K OHM J
RA721	76011223	CHIP, 1/20W 22K OHM J
RA731	76011103	CHIP, 1/20W 10K OHM J
RA741	76000445	CHIP JUMPER, 1608TYPE
RA771	76011103	CHIP, 1/20W 10K OHM J
RA781	76000445	CHIP JUMPER, 1608TYPE
RA791	76000445	CHIP JUMPER, 1608TYPE
RA801	76011223	CHIP, 1/20W 22K OHM J
RB08	76011470	CHIP, 1/20W 47 OHM J
RB09	76011470	CHIP, 1/20W 47 OHM J
RB10	76011331	CHIP, 1/20W 330 OHM J
RB15	76011471	CHIP, 1/20W 470 OHM J
RB24	76000445	CHIP JUMPER, 1608TYPE
RC01	76011681	CHIP, 1/20W 680 OHM J
RC02	76011681	CHIP, 1/20W 680 OHM J
RC03	76011681	CHIP, 1/20W 680 OHM J
RC04	76011681	CHIP, 1/20W 680 OHM J
RC05	76011681	CHIP, 1/20W 680 OHM J
RC06	76011681	CHIP, 1/20W 680 OHM J

Location No.	Parts No.	Description
RC07	76000445	CHIP JUMPER, 1608TYPE
RC08	76000445	CHIP JUMPER, 1608TYPE
RC09	76000445	CHIP JUMPER, 1608TYPE
RC10	76000445	CHIP JUMPER, 1608TYPE
RC11	76011821	CHIP, 1/20W 820 OHM J
RC12	76011821	CHIP, 1/20W 820 OHM J
RC13	76011681	CHIP, 1/20W 680 OHM J
RC14	76011101	CHIP, 1/20W 100 OHM J
RC15	76011330	CHIP, 1/20W 33 OHM J
RC16	76011681	CHIP, 1/20W 680 OHM J
RC17	76011330	CHIP, 1/20W 33 OHM J
RC18	76011330	CHIP, 1/20W 33 OHM J
RC19	76011330	CHIP, 1/20W 33 OHM J
RC20	76011330	CHIP, 1/20W 33 OHM J
RC21	76011330	CHIP, 1/20W 33 OHM J
RC22	76011221	CHIP, 1/20W 220 OHM J
	76011330	CHIP, 1/20W 33 OHM J
RC23	76000445	CHIP JUMPER, 1608TYPE
RC24	76011330	CHIP, 1/20W 33 OHM J
RC31	76000445	CHIP JUMPER, 1608TYPE
RC32	76000445	CHIP JUMPER, 1608TYPE
RC33	76000445	CHIP JUMPER, 1608TYPE
RC34	76000445	CHIP JUMPER, 1608TYPE
RC35	76000445	CHIP JUMPER, 1608TYPE
RC36	76000445	CHIP JUMPER, 1608TYPE
RC37	76000445	CHIP JUMPER, 1608TYPE
RC38	76011330	CHIP, 1/20W 33 OHM J
RC39	76011330	CHIP, 1/20W 33 OHM J
RC40	76011101	CHIP, 1/20W 100 OHM J
RC41	76011101	CHIP, 1/20W 100 OHM J
RC42	76011330	CHIP, 1/20W 33 OHM J
RC43	76011330	CHIP, 1/20W 33 OHM J
RC51	76011101	CHIP, 1/20W 100 OHM J
RC52	76011101	CHIP, 1/20W 100 OHM J
RC53	76011101	CHIP, 1/20W 100 OHM J
RD212	76011101	CHIP, 1/20W 100 OHM J
RD236	76011101	CHIP, 1/20W 100 OHM J
RD237	76011101	CHIP, 1/20W 100 OHM J
RD238	76011101	CHIP, 1/20W 100 OHM J
RD240	76011101	CHIP, 1/20W 100 OHM J
RD248	76011473	CHIP, 1/20W 47K OHM J
RD251	76011332	CHIP, 1/20W 3.3K OHM J
RD252	76011102	CHIP, 1/20W 1K OHM J
RD253	76011223	CHIP, 1/20W 22K OHM J
RD254	76011473	CHIP, 1/20W 47K OHM J
RD255	76011101	CHIP, 1/20W 100 OHM J
RE01	76366153	CARBON FILM, 1/6W 15K OHM J
RE02	76366473	CARBON FILM, 1/6W 47K OHM J
RE03	76366153	CARBON FILM, 1/6W 15K OHM J
RE06	76366473	CARBON FILM, 1/6W 47K OHM J
RE10	76367180	CARBON FILM, 1/6W 18 OHM G
RE11	76367222	CARBON FILM, 1/6W 2.2K OHM G
RE12	76366472	CARBON FILM, 1/6W 4.7K OHM J
RE13	76366102	CARBON FILM, 1/6W 1K OHM J
RE18	76366153	CARBON FILM, 1/6W 15K OHM J
RE19	76366473	CARBON FILM, 1/6W 47K OHM J
RE30	76000164	METAL FILM, 1/4W 39 OHM F
RE31	76000356	METAL FILM, 1/4W 820 OHM F
RE33	76366102	CARBON FILM, 1/6W 1K OHM J
RE35	76182048	METAL FILM 1/4W 220 F
RE36	76182048	METAL FILM 1/4W 220 F
RE37	76000220	METAL FILM, 1/4W 390 OHM F
RE38	76366102	CARBON FILM, 1/6W 1K OHM J
RE50	76382101	OXIDE METAL FILM, 1W 100 OHM J
RE60	76000142	METAL FILM, 1/4W 240 OHM F
RE61	76000360	METAL FILM, 1/4W 1.2K OHM F
RE63	76366102	CARBON FILM, 1/6W 1K OHM J
RE65	76367620	CARBON FILM 1/6W 62 G
RE66	76367222	CARBON FILM, 1/6W 2.2K OHM G
RE90	76000155	METAL FILM, 1/4W 15 OHM F
RE91	76000358	METAL FILM, 1/4W 1K OHM F
RE92	76366101	CARBON FILM, 1/6W 100 OHM J
RE93	76366102	CARBON FILM, 1/6W 1K OHM J
RE94	76553101	OXIDE METAL FILM, 1W 100 OHM J
RE95	76552102	OXIDE METAL FILM, 1/2W 1K OHM J
RE96	76366473	CARBON FILM, 1/6W 47K OHM J

Location No.	Parts No.	Description
RE97	76366472	CARBON FILM, 1/6W 4.7K OHM J
RE98	76366473	CARBON FILM, 1/6W 47K OHM J
RE99	76366101	CARBON FILM, 1/6W 100 OHM J
RR01	76871750	CHIP, 1/8W 75 OHM J
RR02	76871750	CHIP, 1/8W 75 OHM J
RR03	76871750	CHIP, 1/8W 75 OHM J
RR04	76011330	CHIP, 1/20W 33 OHM J
RR05	76011330	CHIP, 1/20W 33 OHM J
RR06	76011330	CHIP, 1/20W 33 OHM J
RR07	76011102	CHIP, 1/20W 1K OHM J
RR10	76011101	CHIP, 1/20W 100 OHM J
RR11	76011101	CHIP, 1/20W 100 OHM J
RR13	76011101	CHIP, 1/20W 100 OHM J
RR14	76011101	CHIP, 1/20W 100 OHM J
RR50	76872750	CHIP, 1/16W 75 OHM J
RS01	76011222	CHIP, 1/20W 2.2K OHM J
RS03	76011101	CHIP, 1/20W 100 OHM J
RS04	76011101	CHIP, 1/20W 100 OHM J
RS05	76011101	CHIP, 1/20W 100 OHM J
RS06	76011101	CHIP, 1/20W 100 OHM J
RS07	76011104	CHIP, 1/20W 100K OHM J
RS08	76011104	CHIP, 1/20W 100K OHM J
RS09	76011104	CHIP, 1/20W 100K OHM J
RS10	76011104	CHIP, 1/20W 100K OHM J
RS11	76011223	CHIP, 1/20W 22K OHM J
RS12	76011104	CHIP, 1/20W 100K OHM J
RS13	76011104	CHIP, 1/20W 100K OHM J
RS16	76011473	CHIP, 1/20W 47K OHM J
RS17	76011473	CHIP, 1/20W 47K OHM J
RS18	76011103	CHIP, 1/20W 10K OHM J
RS19	76011104	CHIP, 1/20W 100K OHM J
RS20	76011104	CHIP, 1/20W 100K OHM J
RS21	76011473	CHIP, 1/20W 47K OHM J
RS22	76011473	CHIP, 1/20W 47K OHM J
RS23	76011223	CHIP, 1/20W 22K OHM J
RS24	76011223	CHIP, 1/20W 22K OHM J
RS25	76011223	CHIP, 1/20W 22K OHM J
RS26	76011223	CHIP, 1/20W 22K OHM J
RS27	76011222	CHIP, 1/20W 2.2K OHM J
RS28	76011222	CHIP, 1/20W 2.2K OHM J
RS29	76011102	CHIP, 1/20W 1K OHM J
RS30	76011102	CHIP, 1/20W 1K OHM J
RS31	76011104	CHIP, 1/20W 100K OHM J
RS32	76011104	CHIP, 1/20W 100K OHM J
RS33	76011473	CHIP, 1/20W 47K OHM J
RS34	76011473	CHIP, 1/20W 47K OHM J
RS35	76011104	CHIP, 1/20W 100K OHM J
RS36	76011101	CHIP, 1/20W 100 OHM J
RS37	76011223	CHIP, 1/20W 22K OHM J
RS38	76011223	CHIP, 1/20W 22K OHM J
RS39	76011101	CHIP, 1/20W 100 OHM J
RS40	76011472	CHIP, 1/20W 4.7K OHM J
RS41	76011472	CHIP, 1/20W 4.7K OHM J
RS42	76011472	CHIP, 1/20W 4.7K OHM J
RS43	76011472	CHIP, 1/20W 4.7K OHM J
RS44	76011472	CHIP, 1/20W 4.7K OHM J
RS45	76011472	CHIP, 1/20W 4.7K OHM J
RS46	76011472	CHIP, 1/20W 4.7K OHM J
RS47	76011472	CHIP, 1/20W 4.7K OHM J
RS48	76011472	CHIP, 1/20W 4.7K OHM J
RS49	76011472	CHIP, 1/20W 4.7K OHM J
RS50	76011472	CHIP, 1/20W 4.7K OHM J
RS51	76011472	CHIP, 1/20W 4.7K OHM J
RS52	76011472	CHIP, 1/20W 4.7K OHM J
RS53	76011472	CHIP, 1/20W 4.7K OHM J
RS54	76011472	CHIP, 1/20W 4.7K OHM J
RS55	76011472	CHIP, 1/20W 4.7K OHM J
RS56	76011472	CHIP, 1/20W 4.7K OHM J
RS57	76011104	CHIP, 1/20W 100K OHM J
RS58	76011101	CHIP, 1/20W 100 OHM J
RS59	76011101	CHIP, 1/20W 100 OHM J
RS60	76011101	CHIP, 1/20W 100 OHM J
RS61	76011101	CHIP, 1/20W 100 OHM J
RS62	76011472	CHIP, 1/20W 4.7K OHM J
RS63	76011473	CHIP, 1/20W 47K OHM J
RS64	76011682	CHIP, 1/20W 6.8K OHM J

Location No.	Parts No.	Description
RS65	76011182	CHIP, 1/20W 1.8K OHM J
RS66	76011100	CHIP, 1/20W 10 OHM J
RS67	76011101	CHIP, 1/20W 100 OHM J
RS68	76011101	CHIP, 1/20W 100 OHM J
RS69	76011222	CHIP, 1/20W 2.2K OHM J
RS70	76011222	CHIP, 1/20W 2.2K OHM J
RS71	76011102	CHIP, 1/20W 1K OHM J
RS72	76011102	CHIP, 1/20W 1K OHM J
RS73	76011391	CHIP, 1/20W 390 OHM J
RS74	76011104	CHIP, 1/20W 100K OHM J
RS76	76011101	CHIP, 1/20W 100 OHM J
RS77	76011472	CHIP, 1/20W 4.7K OHM J
RS78	76011102	CHIP, 1/20W 1K OHM J
RS79	76011101	CHIP, 1/20W 100 OHM J
RS80	76011472	CHIP, 1/20W 4.7K OHM J
RS81	76011102	CHIP, 1/20W 1K OHM J
RS82	76011472	CHIP, 1/20W 4.7K OHM J
RS83	76011472	CHIP, 1/20W 4.7K OHM J
RS85	76011472	CHIP, 1/20W 4.7K OHM J
RS86	76011472	CHIP, 1/20W 4.7K OHM J
RS87	76011101	CHIP, 1/20W 100 OHM J
RS88	76011101	CHIP, 1/20W 100 OHM J
RS89	76011104	CHIP, 1/20W 100K OHM J
RS90	76011391	CHIP, 1/20W 390 OHM J
RS91	76011473	CHIP, 1/20W 47K OHM J
RS96	76011223	CHIP, 1/20W 22K OHM J
RS97	76011223	CHIP, 1/20W 22K OHM J
RS301	76011102	CHIP, 1/20W 1K OHM J
RS302	76011104	CHIP, 1/20W 100K OHM J
RS303	76011104	CHIP, 1/20W 100K OHM J
RS304	76000445	CHIP JUMPER, 1608TYPE
RS305	76000445	CHIP JUMPER, 1608TYPE
RS400	76011822	CHIP, 1/20W 8.2K OHM J
RS401	76011123	CHIP, 1/20W 12K OHM J
RS402	76011101	CHIP, 1/20W 100 OHM J
RS403	76011101	CHIP, 1/20W 100 OHM J
RS404	76011123	CHIP, 1/20W 12K OHM J
RS405	76011822	CHIP, 1/20W 8.2K OHM J
RS416	76011473	CHIP, 1/20W 47K OHM J
RS417	76011473	CHIP, 1/20W 47K OHM J
RS529	76011223	CHIP, 1/20W 22K OHM J
RS530	76011103	CHIP, 1/20W 10K OHM J
RT01	76011101	CHIP, 1/20W 100 OHM J
RT02	76011273	CHIP, 1/20W 27K OHM J
RT03	76011683	CHIP, 1/20W 68K OHM J
RT04	76011102	CHIP, 1/20W 1K OHM J
RT05	76011101	CHIP, 1/20W 100 OHM J
RT06	76011391	CHIP, 1/20W 390 OHM J
RT07	76011821	CHIP, 1/20W 820 OHM J
RT08	76011151	CHIP, 1/20W 150 OHM J
RT09	76011471	CHIP, 1/20W 470 OHM J
RT10	76011101	CHIP, 1/20W 100 OHM J
RT11	76011471	CHIP, 1/20W 470 OHM J
RT12	76011102	CHIP, 1/20W 1K OHM J
RV01	76011101	CHIP, 1/20W 100 OHM J
RV02	76011101	CHIP, 1/20W 100 OHM J
RV03	76011101	CHIP, 1/20W 100 OHM J
RV04	76011101	CHIP, 1/20W 100 OHM J
RV05	76011101	CHIP, 1/20W 100 OHM J
RV06	76011101	CHIP, 1/20W 100 OHM J
RV07	76011101	CHIP, 1/20W 100 OHM J
RV08	76011101	CHIP, 1/20W 100 OHM J
RV09	76011562	CHIP, 1/20W 5.6K OHM J
RV10	76011101	CHIP, 1/20W 100 OHM J
RV11	76011101	CHIP, 1/20W 100 OHM J
RV12	76011101	CHIP, 1/20W 100 OHM J
RV13	76011101	CHIP, 1/20W 100 OHM J
RV14	76011101	CHIP, 1/20W 100 OHM J
RV15	76011101	CHIP, 1/20W 100 OHM J
RV16	76011101	CHIP, 1/20W 100 OHM J
RV17	76011101	CHIP, 1/20W 100 OHM J
RV18	76011101	CHIP, 1/20W 100 OHM J
RV19	76011101	CHIP, 1/20W 100 OHM J
RV20	76011101	CHIP, 1/20W 100 OHM J
RV21	76011101	CHIP, 1/20W 100 OHM J
RV22	76011101	CHIP, 1/20W 100 OHM J

Location No.	Parts No.	Description
RV26	76011101	CHIP, 1/20W 100 OHM J
RV27	76011101	CHIP, 1/20W 100 OHM J
RV28	76011103	CHIP, 1/20W 10K OHM J
RV29	76011103	CHIP, 1/20W 10K OHM J
RV30	76019388	CHIP, 1/16W 10K OHM F
RV31	76019388	CHIP, 1/16W 10K OHM F
RV32	76019388	CHIP, 1/16W 10K OHM F
RV33	76989227	CHIP, 1/16W 5.1K OHM F
RV34	76989227	CHIP, 1/16W 5.1K OHM F
RV35	76989227	CHIP, 1/16W 5.1K OHM F
RV36	76019349	CHIP, 1/16W 1K OHM F
RV37	76019349	CHIP, 1/16W 1K OHM F
RV38	76019349	CHIP, 1/16W 1K OHM F
RV39	76011470	CHIP, 1/20W 47 OHM J
RV40	76011101	CHIP, 1/20W 100 OHM J
RV41	76011101	CHIP, 1/20W 100 OHM J
RV43	76011101	CHIP, 1/20W 100 OHM J
RV44	76011101	CHIP, 1/20W 100 OHM J
RV45	76871681	CHIP, 1/8W 680 OHM J
RV46	76871331	CHIP, 1/8W 330 OHM J
RV47	76011121	CHIP, 1/20W 120 OHM J
RV48	76011121	CHIP, 1/20W 120 OHM J
RV49	76871331	CHIP, 1/8W 330 OHM J
RV50	76011101	CHIP, 1/20W 100 OHM J
RV51	76011101	CHIP, 1/20W 100 OHM J
RV53	76011101	CHIP, 1/20W 100 OHM J
RV54	76011222	CHIP, 1/20W 2.2K OHM J
RV55	76011121	CHIP, 1/20W 120 OHM J
RV56	76011101	CHIP, 1/20W 100 OHM J
RV57	76011101	CHIP, 1/20W 100 OHM J
RV58	76871271	CHIP, 1/8W 270 OHM J
RV59	76871271	CHIP, 1/8W 270 OHM J
RV61	76011104	CHIP, 1/20W 100K OHM J
RV64	76011470	CHIP, 1/20W 47 OHM J
RV65	76011470	CHIP, 1/20W 47 OHM J
RV80	76872750	CHIP, 1/16W 75 OHM J
RV81	76872750	CHIP, 1/16W 75 OHM J
RV82	76872750	CHIP, 1/16W 75 OHM J
RV121	76872750	CHIP, 1/16W 75 OHM J
RV122	76872750	CHIP, 1/16W 75 OHM J
RV123	76872750	CHIP, 1/16W 75 OHM J
RV129	76011101	CHIP, 1/20W 100 OHM J
RV212	76872750	CHIP, 1/16W 75 OHM J
RV213	76872750	CHIP, 1/16W 75 OHM J
RV214	76872750	CHIP, 1/16W 75 OHM J
RV215	76872750	CHIP, 1/16W 75 OHM J
RV216	76872472	CHIP, 1/16W 4.7K OHM J
RV218	76872750	CHIP, 1/16W 75 OHM J
RV219	76872750	CHIP, 1/16W 75 OHM J
RV220	76872750	CHIP, 1/16W 75 OHM J
RV229	76872750	CHIP, 1/16W 75 OHM J
RV231	76011100	CHIP, 1/20W 10 OHM J
RV232	76011100	CHIP, 1/20W 10 OHM J
RV233	76011100	CHIP, 1/20W 10 OHM J
RV235	76872750	CHIP, 1/16W 75 OHM J
RV236	76872750	CHIP, 1/16W 75 OHM J
RV237	76872750	CHIP, 1/16W 75 OHM J
RV238	76872472	CHIP, 1/16W 4.7K OHM J
RV240	76872750	CHIP, 1/16W 75 OHM J
RV241	76872750	CHIP, 1/16W 75 OHM J
RV250	76872750	CHIP, 1/16W 75 OHM J
RV251	76872750	CHIP, 1/16W 75 OHM J
RY01	76011101	CHIP, 1/20W 100 OHM J
RY02	76011101	CHIP, 1/20W 100 OHM J
RY03	76011101	CHIP, 1/20W 100 OHM J
RY04	76871271	CHIP, 1/8W 270 OHM J
RY05	76871271	CHIP, 1/8W 270 OHM J
RY06	76871271	CHIP, 1/8W 270 OHM J
RY07	76011470	CHIP, 1/20W 47 OHM J
RY08	76011470	CHIP, 1/20W 47 OHM J
RY09	76011470	CHIP, 1/20W 47 OHM J
GC01	76000445	CHIP JUMPER, 1608TYPE
GC02	76000445	CHIP JUMPER, 1608TYPE
GC03	76000445	CHIP JUMPER, 1608TYPE
GC04	76000445	CHIP JUMPER, 1608TYPE
GC06	76000445	CHIP JUMPER, 1608TYPE

Location No.	Parts No.	Description
GJ413	76000445	CHIP JUMPER, 1608TYPE
GJ414	76000445	CHIP JUMPER, 1608TYPE
GJ603	76000445	CHIP JUMPER, 1608TYPE
GR02	76000445	CHIP JUMPER, 1608TYPE
GR03	76000445	CHIP JUMPER, 1608TYPE
GR25	76000445	CHIP JUMPER, 1608TYPE
GR26	76000445	CHIP JUMPER, 1608TYPE
GR27	76000445	CHIP JUMPER, 1608TYPE
GR28	76000445	CHIP JUMPER, 1608TYPE
GR101	76000445	CHIP JUMPER, 1608TYPE
GR102	76000445	CHIP JUMPER, 1608TYPE
GR103	76000445	CHIP JUMPER, 1608TYPE
GR501	76000445	CHIP JUMPER, 1608TYPE
GR605	76000445	CHIP JUMPER, 1608TYPE
GR610	76000445	CHIP JUMPER, 1608TYPE
GR611	76000445	CHIP JUMPER, 1608TYPE
GRC01	76000445	CHIP JUMPER, 1608TYPE
GRC02	76000445	CHIP JUMPER, 1608TYPE
GRC03	76000445	CHIP JUMPER, 1608TYPE
GRC04	76000445	CHIP JUMPER, 1608TYPE
GRC05	76000445	CHIP JUMPER, 1608TYPE
GRC06	76000445	CHIP JUMPER, 1608TYPE
GRC07	76000445	CHIP JUMPER, 1608TYPE
GRC08	76000445	CHIP JUMPER, 1608TYPE
GRC09	76000445	CHIP JUMPER, 1608TYPE
GRC10	76000445	CHIP JUMPER, 1608TYPE
GRC11	76000445	CHIP JUMPER, 1608TYPE
GRC12	76000445	CHIP JUMPER, 1608TYPE
GRC13	76000445	CHIP JUMPER, 1608TYPE
GRC14	76000445	CHIP JUMPER, 1608TYPE
GRR04	76000445	CHIP JUMPER, 1608TYPE
GRR05	76000445	CHIP JUMPER, 1608TYPE
GRR14	76000445	CHIP JUMPER, 1608TYPE
GRR15	76000445	CHIP JUMPER, 1608TYPE
GRR16	76000445	CHIP JUMPER, 1608TYPE
GRR44	76000445	CHIP JUMPER, 1608TYPE
GRV07	76000445	CHIP JUMPER, 1608TYPE
GRV08	76000445	CHIP JUMPER, 1608TYPE
GRV09	76000445	CHIP JUMPER, 1608TYPE
GRV10	76000445	CHIP JUMPER, 1608TYPE
GRV11	76000445	CHIP JUMPER, 1608TYPE
GRV12	76000445	CHIP JUMPER, 1608TYPE
GRV15	76000445	CHIP JUMPER, 1608TYPE
GRV16	76000445	CHIP JUMPER, 1608TYPE
GRV19	76000445	CHIP JUMPER, 1608TYPE
GRV33	76000445	CHIP JUMPER, 1608TYPE
GRV34	76000445	CHIP JUMPER, 1608TYPE
GRV35	76000445	CHIP JUMPER, 1608TYPE
GRV36	76000445	CHIP JUMPER, 1608TYPE
GRV37	76000445	CHIP JUMPER, 1608TYPE
GRV38	76000445	CHIP JUMPER, 1608TYPE
GRV39	76000445	CHIP JUMPER, 1608TYPE
GRV40	76000445	CHIP JUMPER, 1608TYPE
GRV41	76000445	CHIP JUMPER, 1608TYPE
GRV42	76000445	CHIP JUMPER, 1608TYPE
GRV43	76000445	CHIP JUMPER, 1608TYPE
GRV44	76000445	CHIP JUMPER, 1608TYPE
GRV51	76000445	CHIP JUMPER, 1608TYPE
GRV52	76000445	CHIP JUMPER, 1608TYPE
GRV53	76000445	CHIP JUMPER, 1608TYPE
GRY01	76000445	CHIP JUMPER, 1608TYPE
GRY02	76000445	CHIP JUMPER, 1608TYPE
GRY03	76000445	CHIP JUMPER, 1608TYPE
GRY04	76000445	CHIP JUMPER, 1608TYPE
GRY05	76000445	CHIP JUMPER, 1608TYPE
GRY06	76000445	CHIP JUMPER, 1608TYPE
GT01	76000445	CHIP JUMPER, 1608TYPE
GT02	76000445	CHIP JUMPER, 1608TYPE
COILS & TRANSFORMERS		
L101	23248398	COIL, CHOKE, TLN3278D
L102	23103828	INDUCTOR, BEAD, TEM2121M
L103	23103828	INDUCTOR, BEAD, TEM2121M
L104	23103828	INDUCTOR, BEAD, TEM2121M
L105	23277002	FERRITE CORE, A CM3225-102-2PT100
L190	23103828	INDUCTOR, BEAD, TEM2121M

Location No.	Parts No.	Description
L505	23289022	COIL, PEAKING, TRF4100AT
L820	23248491	COIL, CHOKE 26X13 108MMH 5A TLN3641AF
L821	23248491	COIL, CHOKE 26X13 108MMH 5A TLN3641AF
L824	23103330	FILTER, FERRITE CHOKE 3.5X5X2 TEM2014AH
L825	23103304	FERRITE CHOKE, TEM2011AA
L840	23289981	COIL, PEAKING, TRF4330AZ
L860	23103320	COIL, CHOKE, TEM2011
L862	23103320	COIL, CHOKE, TEM2011
L870	23103320	COIL, CHOKE, TEM2011
L871	23103320	COIL, CHOKE, TEM2011
L878	23248489	COIL, CHOKE COIL 1.5MMH 8A TLN3639AH
L880	23103304	FERRITE CHOKE, TEM2011AA
L881	23248388	COIL, CHOKE 9X11H 4.7MMHK 4.0A TLN3515AA
L883	23103304	FERRITE CHOKE, TEM2011AA
L884	23248387	COIL, CHOKE 9X11H 22MMHK 2.5ATLN3499AA
L886	23103304	FERRITE CHOKE, TEM2011AA
L8211	23103330	FILTER, FERRITE CHOKE 3.5X5X2 TEM2014AH
L8212	23103330	FILTER, FERRITE CHOKE 3.5X5X2 TEM2014AH
LC01	23103828	INDUCTOR, BEAD, TEM2121M
LC02	23103828	INDUCTOR, BEAD, TEM2121M
LC03	23103828	INDUCTOR, BEAD, TEM2121M
LC04	23103828	INDUCTOR, BEAD, TEM2121M
LC05	23103828	INDUCTOR, BEAD, TEM2121M
LC13	23103828	INDUCTOR, BEAD, TEM2121M
LC21	23103828	INDUCTOR, BEAD, TEM2121M
LC22	23103828	INDUCTOR, BEAD, TEM2121M
LC23	23103828	INDUCTOR, BEAD, TEM2121M
LC24	23103828	INDUCTOR, BEAD, TEM2121M
LC25	23103828	INDUCTOR, BEAD, TEM2121M
LC26	23103828	INDUCTOR, BEAD, TEM2121M
LC27	23103828	INDUCTOR, BEAD, TEM2121M
LC28	23103828	INDUCTOR, BEAD, TEM2121M
LC29	23103828	INDUCTOR, BEAD, TEM2121M
LC30	23103828	INDUCTOR, BEAD, TEM2121M
LC31	23103238	INDUCTOR, BEAD, TEM2142AD
LC32	23103238	INDUCTOR, BEAD, TEM2142AD
LC33	23103238	INDUCTOR, BEAD, TEM2142AD
LC51	23103239	INDUCTOR, BEAD, TEM2143AD
LC52	23103239	INDUCTOR, BEAD, TEM2143AD
LC53	23103239	INDUCTOR, BEAD, TEM2143AD
LC54	23103239	INDUCTOR, BEAD, TEM2143AD
LD203	23103828	INDUCTOR, BEAD, TEM2121M
LE10	23289980	COIL, PEAKING, TRF4220AZ
LE30	23248456	COIL, CHOKE, TLN3540AH
LE31	23289980	COIL, PEAKING, TRF4220AZ
LE32	23248432	COIL, CHOKE, TLN3499AH
LE60	23248456	COIL, CHOKE, TLN3540AH
LE61	23289980	COIL, PEAKING, TRF4220AZ
LE62	23248432	COIL, CHOKE, TLN3499AH
LE90	23248456	COIL, CHOKE, TLN3540AH
LE91	23289980	COIL, PEAKING, TRF4220AZ
LE92	23248432	COIL, CHOKE, TLN3499AH
LT01	23289028	COIL, PEAKING, TRF4101AT
LV02	23277002	FERRITE CORE, A CM3225-102-2PT100
LV03	23277002	FERRITE CORE, A CM3225-102-2PT100
LV15	23289022	COIL, PEAKING, TRF4100AT
△ T801	23211904	COIL, LINE FILTER 35X34H 10MH TRF3255AF
△ T802	23211904	COIL, LINE FILTER 35X34H 10MH TRF3255AF
△ T820	23217799	TRANSFORMER, CONVERTER TPW3564AS
△ T822	23248490	COIL, CHOKE EI25 5.3MMH 8.0A TLN3640AH
△ T840	23217800	TRANSFORMER, CONVERTER TPW3565AS
△ T860	23217802	TRANSFORMER, CONVERTER TPW3567AS
△ T880	23217801	TRANSFORMER, CONVERTER TPW3566AS
ZA01	23103840	FERRITE CORE, TFE1013
ZA02	23103778	FERRITE CORE, TFE1008
ZA03	23103914	FERRITE CORE, TFE1015AD
ZA04	23103914	FERRITE CORE, TFE1015AD
ZA05	23103839	FERRITE CORE, TFE1012
ZA06	23103914	FERRITE CORE, TFE1015AD
ZA08	23103348	CORE, FERRITE CORE AAA
SEMICONDUCTORS		
IC414	23085938	IC, BU4242G-TR
Q101	23205506	TRANSISTOR, 2SC4081 Q
Q501	23085049	IC, TB1274BFG(DRY)
Q504	23205507	TRANSISTOR, 2SA1576A Q

Location No.	Parts No.	Description
Q610	23085826	IC, 2CH POWER IC HZIP-12P TA8246AHQ(5)
Q612	23205443	TRANSISTOR, 2SA1162-Y(F)
Q615	23205325	TRANSISTOR, RN2404(F)
Q620	23205506	TRANSISTOR, 2SC4081 Q
Q621	23205506	TRANSISTOR, 2SC4081 Q
Q622	23205506	TRANSISTOR, 2SC4081 Q
Q627	23205325	TRANSISTOR, RN2404(F)
Q664	23205506	TRANSISTOR, 2SC4081 Q
Q665	23205325	TRANSISTOR, RN2404(F)
Q671	23205302	TRANSISTOR, 2SC3326-B(F)
Q672	23205302	TRANSISTOR, 2SC3326-B(F)
Q812	23205506	TRANSISTOR, 2SC4081 Q
△ Q813	23000823	IC, PHOTO COUPLER, TLP421F(GR)
Q814	23205506	TRANSISTOR, 2SC4081 Q
Q815	23205506	TRANSISTOR, 2SC4081 Q
Q816	23205506	TRANSISTOR, 2SC4081 Q
Q820	23135094	IC, PFC 7PIN SRX2039
△ Q821	23000823	IC, PHOTO COUPLER, TLP421F(GR)
Q822	23205339	TRANSISTOR, 2SC2655-Y(F)
Q840	23135083	IC, HYBRID VDSS=800V
△ Q841	23000823	IC, PHOTO COUPLER, TLP421F(GR)
Q842	23085389	IC, NJM431L
Q860	23135066	IC, STRZ4479
△ Q862	23000823	IC, PHOTO COUPLER, TLP421F(GR)
△ Q863	23000823	IC, PHOTO COUPLER, TLP421F(GR)
Q864	23205339	TRANSISTOR, 2SC2655-Y(F)
Q870	23085389	IC, NJM431L
Q880	23135072	IC, STRW6765
△ Q881	23000823	IC, PHOTO COUPLER, TLP421F(GR)
Q882	23085389	IC, NJM431L
Q4100	23085635	TRANSISTOR, 2SC3437-Y(TE85L,F)
Q4101	23085635	TRANSISTOR, 2SC3437-Y(TE85L,F)
Q4102	23085635	TRANSISTOR, 2SC3437-Y(TE85L,F)
Q4103	23085635	TRANSISTOR, 2SC3437-Y(TE85L,F)
Q8191	23205506	TRANSISTOR, 2SC4081 Q
Q8230	23205328	TRANSISTOR, RN1405(F)
Q8231	23205506	TRANSISTOR, 2SC4081 Q
Q8310	23205328	TRANSISTOR, RN1405(F)
Q8311	23205506	TRANSISTOR, 2SC4081 Q
Q8312	23205506	TRANSISTOR, 2SC4081 Q
Q8390	23205506	TRANSISTOR, 2SC4081 Q
△ Q8391	23000823	IC, PHOTO COUPLER, TLP421F(GR)
Q8601	23205329	TRANSISTOR, RN1404(F)
Q8602	23205506	TRANSISTOR, 2SC4081 Q
Q8701	23205506	TRANSISTOR, 2SC4081 Q
Q8702	23205329	TRANSISTOR, RN1404(F)
Q8703	23205328	TRANSISTOR, RN1405(F)
Q8704	23085338	IC, BD5245G-TR
Q8801	23205329	TRANSISTOR, RN1404(F)
Q8802	23205329	TRANSISTOR, RN1404(F)
QB04	23205463	TRANSISTOR, 2SC2712-Y(TE85L,F)
QB07	23205463	TRANSISTOR, 2SC2712-Y(TE85L,F)
QD80	23085555	IC, PQ05RD11J00H
QD207	23085991	IC, TMP87C809BMG-6EJ8
QD208	23085434	IC, RESET 4.3V SOT-25 PST9143NR
QD209	23205330	TRANSISTOR, RN1403(F)
QE01	23205376	TRANSISTOR, 2SC5343-Y(BULK)
QE02	23205376	TRANSISTOR, 2SC5343-Y(BULK)
QE03	23205315	TRANSISTOR, RN1206(F)
QE10	23135077	IC, SI-3090CA
QE11	23205315	TRANSISTOR, RN1206(F)
QE30	23085397	IC, SI-8033SS
QE35	23085836	IC, VO=1.5V-15V 1A ON/OFF 5PIN PQ150VB01FZH
QE60	23085381	IC, SI-8050SS
QE65	23135076	IC, SI-3050C
QE90	23085381	IC, SI-8050SS
QE91	23205376	TRANSISTOR, 2SC5343-Y(BULK)
QE92	23205376	TRANSISTOR, 2SC5343-Y(BULK)
QE93	23205315	TRANSISTOR, RN1206(F)
QE95	23205442	TRANSISTOR, 2SC3852
QR01	23085536	IC, TC7S86F
QR03	23318981	IC, MC14053BF
QR20	23205507	TRANSISTOR, 2SA1576A Q
QS01	23009916	IC, MM1631AJBE
QS02	23009614	IC, CD4053BNSR
QS03	23205302	TRANSISTOR, 2SC3326-B(F)

Location No.	Parts No.	Description
QS04	23205302	TRANSISTOR, 2SC3326-B(F)
QS05	23205325	TRANSISTOR, RN2404(F)
QS06	23205302	TRANSISTOR, 2SC3326-B(F)
QS07	23205302	TRANSISTOR, 2SC3326-B(F)
QS08	23205506	TRANSISTOR, 2SC4081 Q
QS09	23205506	TRANSISTOR, 2SC4081 Q
QS10	23205302	TRANSISTOR, 2SC3326-B(F)
QS11	23205302	TRANSISTOR, 2SC3326-B(F)
QS12	23085576	IC, OP AMP, BA4558F
QS14	23205302	TRANSISTOR, 2SC3326-B(F)
QS18	23205302	TRANSISTOR, 2SC3326-B(F)
QS19	23205506	TRANSISTOR, 2SC4081 Q
QS20	23205506	TRANSISTOR, 2SC4081 Q
QS21	23205506	TRANSISTOR, 2SC4081 Q
QS31	23085576	IC, OP AMP, BA4558F
QS41	23205506	TRANSISTOR, 2SC4081 Q
QS43	23205506	TRANSISTOR, 2SC4081 Q
QS52	23205463	TRANSISTOR, 2SC2712-Y(TE85L,F)
QS108	23205506	TRANSISTOR, 2SC4081 Q
QT01	23205507	TRANSISTOR, 2SA1576A Q
QT02	23205506	TRANSISTOR, 2SC4081 Q
QT03	23205507	TRANSISTOR, 2SA1576A Q
QT04	23085392	IC, MM1501XN
QT05	23205507	TRANSISTOR, 2SA1576A Q
QT06	23205402	TRANSISTOR, DTC144EU A
QV01	23009940	IC, MM1630AQ
QV03	23205506	TRANSISTOR, 2SC4081 Q
QV04	23205506	TRANSISTOR, 2SC4081 Q
QV06	23205506	TRANSISTOR, 2SC4081 Q
QV07	23205506	TRANSISTOR, 2SC4081 Q
QV10	23009418	IC, MM1505XNRE
QV11	23009418	IC, MM1505XNRE
QV12	23009418	IC, MM1505XNRE
QY01	23205506	TRANSISTOR, 2SC4081 Q
QY02	23205506	TRANSISTOR, 2SC4081 Q
QY03	23205506	TRANSISTOR, 2SC4081 Q
D607	23357802	DIODE, ZENER, MA8330-M
D612	23362140	DIODE, KDS160-RTK
D613	23362140	DIODE, KDS160-RTK
D614	23362140	DIODE, KDS160-RTK
D617	23362140	DIODE, KDS160-RTK
D618	23362140	DIODE, KDS160-RTK
D619	23362140	DIODE, KDS160-RTK
D640	23362140	DIODE, KDS160-RTK
D641	23362140	DIODE, KDS160-RTK
D674	23362140	DIODE, KDS160-RTK
D675	23362140	DIODE, KDS160-RTK
D809	76000656	VARIATOR, TNR15G471K
D811	23357841	DIODE, ZENER, MTZJ6.8A
D815	23357692	DIODE, ZENER, RD2.0ESA B2
D816	23357738	DIODE, ZENER, MA8047-L
D819	23357718	THYRISTOR, SF0R3G42(N,G5H1)
D820	23357913	DIODE, RBV-1506, LF-A
D821	23362240	DIODE, VRM=1200V IF(AV)=3A FMC-26UAR
D822	23362220	DIODE, VRM=600V IF=5A FMX-G16S
D823	23362223	DIODE, VRM=600V IF=1.2A DO201AD :RM3A,LF014-102
D825	23357899	DIODE, ZENER, MTZJ33A
D826	23357513	DIODE, EU2A
D828	76000656	VARIATOR, TNR15G471K
D841	23362221	DIODE, VRM=1000V 1.0A EM1C ,LF-F7
D842	23362221	DIODE, VRM=1000V 1.0A EM1C ,LF-F7
D843	23357854	DIODE, ZENER, MTZJ10B
D844	23357837	DIODE, ZENER, MTZJ5.6B
D845	23357510	DIODE, AG01
D846	23357513	DIODE, EU2A
D860	23357850	DIODE, ZENER, MTZJ9.1A
D861	23357893	DIODE, ZENER, MTZJ27C
D862	23357893	DIODE, ZENER, MTZJ27C
D863	23357854	DIODE, ZENER, MTZJ10B
D864	23357854	DIODE, ZENER, MTZJ10B
D865	23357513	DIODE, EU2A
D866	23357853	DIODE, ZENER, MTZJ10A
D870	23362219	DIODE, VRM=100V IF=20A FME-220A(023-108)
D871	23362219	DIODE, VRM=100V IF=20A FME-220A(023-108)
D874	23362219	DIODE, VRM=100V IF=20A FME-220A(023-108)
D880	23357513	DIODE, EU2A

Location No.	Parts No.	Description
D881	23357104	DIODE, 1SS244
D882	23357104	DIODE, 1SS244
D883	23357837	DIODE, ZENER, MTZJ5.6B
D884	23362219	DIODE, VRM=100V IF=20A FME-220A(023-108)
D885	23357513	DIODE, EU2A
D886	23357408	DIODE, FMX-12S(023-108)
D887	23357900	DIODE, ZENER, MTZJ33B
D888	23357848	DIODE, ZENER, MTZJ8.2B
D889	23357848	DIODE, ZENER, MTZJ8.2B
D890	23357847	DIODE, ZENER, MTZJ8.2A
D891	23357847	DIODE, ZENER, MTZJ8.2A
D892	23357892	DIODE, ZENER, MTZJ27B
D8230	23357792	DIODE, ZENER 22.80-23.97 MA8240-L, TX
D8231	23357703	DIODE, 1SS355
D8232	23357745	DIODE, ZENER, MA8056-M
D8271	23357697	DIODE, 1SS133
D8272	23357910	DIODE, ZENER, MTZJ39D
D8273	23357883	DIODE, ZENER, MTZJ22A
D8274	23357883	DIODE, ZENER, MTZJ22A
D8310	23357703	DIODE, 1SS355
D8311	23357745	DIODE, ZENER, MA8056-M
D8312	23357703	DIODE, 1SS355
D8313	23357762	DIODE, ZENER, MA8091-M
D8390	23357889	DIODE, ZENER, MTZJ24C
D8391	23357890	DIODE, ZENER, MTZJ24D
D8401	23357703	DIODE, 1SS355
D8402	23357703	DIODE, 1SS355
D8403	23357703	DIODE, 1SS355
D8404	23357703	DIODE, 1SS355
D8601	23357703	DIODE, 1SS355
D8602	23357731	DIODE, ZENER, MA8033-H
D8701	23357703	DIODE, 1SS355
D8702	23357703	DIODE, 1SS355
D8705	23357894	DIODE, ZENER, MTZJ27D
D8706	23357703	DIODE, 1SS355
D8801	23357703	DIODE, 1SS355
D8802	23357703	DIODE, 1SS355
D8803	23357778	DIODE, ZENER, MA8150-M
D8804	23357703	DIODE, 1SS355
D8805	23357745	DIODE, ZENER, MA8056-M
DA011	23357751	DIODE, ZENER, MA8068-M
DA061	23357751	DIODE, ZENER, MA8068-M
DA071	23357751	DIODE, ZENER, MA8068-M
DB01	23358606	DIODE, LED RED, SLR-56VC3FPQ
DB02	23358606	DIODE, LED GREEN, SLR-56MC3FPQR
DB20	23357406	DIODE, ZENER, UDZS5.6B
DB22	23357703	DIODE, 1SS355
DB23	23357703	DIODE, 1SS355
DD202	23362140	DIODE, KDS160-R TK
DD204	23362140	DIODE, KDS160-R TK
DD206	23362140	DIODE, KDS160-R TK
DE01	23357706	DIODE, AK04
DE02	23357706	DIODE, AK04
DE03	23357823	DIODE, ZENER, MTZJ3.6A
DE07	23357821	DIODE, ZENER, MTZJ3.3A
DE30	23357810	DIODE, FMB-G14L
DE31	23357697	DIODE, 1SS133
DE32	23357829	DIODE, ZENER, MTZJ4.3C
DE60	23357810	DIODE, FMB-G14L
DE61	23357697	DIODE, 1SS133
DE62	23357845	DIODE, ZENER, MTZJ7.5B
DE90	23357810	DIODE, FMB-G14L
DE91	23357697	DIODE, 1SS133
DE92	23357912	DIODE, ZENER, MTZJ6.2C
DE97	23357895	DIODE, ZENER, MTZJ30A
DE99	23357840	DIODE, ZENER, MTZJ6.2B
DR70	23362140	DIODE, KDS160-R TK
DR71	23362140	DIODE, KDS160-R TK
DS10	23357757	DIODE, ZENER, MA8039-H
DS13	23362140	DIODE, KDS160-R TK
DS16	23357744	DIODE, ZENER, MA8056-L
DV01	23357762	DIODE, ZENER, MA8091-M
DV02	23357762	DIODE, ZENER, MA8091-M
DV03	23357762	DIODE, ZENER, MA8091-M
DV04	23357762	DIODE, ZENER, MA8091-M
DV05	23357762	DIODE, ZENER, MA8091-M

Location No.	Parts No.	Description
DV06	23357762	DIODE, ZENER, MA8091-M
DV07	23357762	DIODE, ZENER, MA8091-M
DV08	23357762	DIODE, ZENER, MA8091-M
DV09	23357762	DIODE, ZENER, MA8091-M
DV10	23357762	DIODE, ZENER, MA8091-M
DV11	23357762	DIODE, ZENER, MA8091-M
DV12	23357762	DIODE, ZENER, MA8091-M
DV13	23357762	DIODE, ZENER, MA8091-M
DV14	23357762	DIODE, ZENER, MA8091-M
DV15	23357762	DIODE, ZENER, MA8091-M
DV16	23357762	DIODE, ZENER, MA8091-M
DV17	23357762	DIODE, ZENER, MA8091-M
DV18	23357762	DIODE, ZENER, MA8091-M
DV19	23357762	DIODE, ZENER, MA8091-M
DV20	23357762	DIODE, ZENER, MA8091-M
DV21	23357762	DIODE, ZENER, MA8091-M
DV24	23357762	DIODE, ZENER, MA8091-M
DV30	23362140	DIODE, KDS160-R TK
DV31	23362140	DIODE, KDS160-R TK
DV32	23362140	DIODE, KDS160-R TK
DV33	23362140	DIODE, KDS160-R TK
DV34	23362140	DIODE, KDS160-R TK
DV35	23362140	DIODE, KDS160-R TK
KB01	23009710	REMOCON RECEIVER, GP1UE281RK
MISCELLANEOUS		
A245	#1 23717214	SCREW, BITTB3X12SBN
A246	#1 23717267	SCREW, BITTB4X16 SBN
A360	#2 23717257	SCREW, PP5X8+SW+W ECO
A370	23717267	SCREW, BITTB4X16 SBN
A375	#2 23717214	SCREW, BITTB3X12SBN
A380	23717214	SCREW, BITTB3X12SBN
A385	23717219	SCREW, PP3X8+SW+W SBN
A410	23717219	SCREW, PP3X8+SW+W SBN
A411	23717267	SCREW, BITTB4X16 SBN
A440	23738074	SCREW, PP 5X16 SW+W SBN
△ B001	#1 23301643	DISPLAY, 05SHP32 LQ315T3LZ21
△ B001	#2 23301659	DISPLAY, G5SHP37 LQ370T3LZ41
B002	23148448	DVB T MODULE, 16PING08
B101	#2 23059224	CHASSIS FRAME, CHASSIS FR
B214	#1 23469396	INSULATOR, INSULATOR POWER
B215	23469405	INSULATOR, INSULATOR AC
B310	23717219	SCREW, PP3X8+SW+W SBN
B311	23717214	SCREW, BITTB3X12SBN
B321	23717214	SCREW, BITTB3X12SBN
△ F801	23144406	FUSE, CERA 5X20 250V 6.3A
F801A	23165433	FUSE HOLDER, 5.2
F801B	23165433	FUSE HOLDER, 5.2
△ F820	23144378	FUSE, RADIAL LEAD SUB-MINIATUR 250V 2A
△ F870	23144378	FUSE, RADIAL LEAD SUB-MINIATUR 250V 2A
H001B	23368945	CABLE, PAL
J207A	23960136	ADHESIVE, SILICONE, TSE3843-W
MJ22	23389359	CABLE, FFC 0.5 50P L70 GOLD
MJ60	23389359	CABLE, FFC 0.5 50P L70 GOLD
MV99	23389333	FFC, 20706SFWR-P=1.0-L1-19-137 P1.0-19P-145(WR)
MZ01	23368908	CABLE, LVDS30P170MM SHP T2 E30-X30
MZ10	23103348	CORE, FERRITE CORE AAA
P602A	23713938	CONNECTOR, CONNECT B5B-PH-K-S(LF)
P661	23023302	EARPHONE JACK
P662	23023302	EARPHONE JACK
△ P801	23372353	POWER CORD, UK 250V3A FL/FUSE13 AC250V 3A FUSE13
△ P801A	23713702	PLUG, 2P 11.88MM W VT
P803A	23713764	PLUG, 13P
P803B	23713764	PLUG, 13P
P807A	23713764	PLUG, 13P
P807B	23713764	PLUG, 13P
P809A	23713763	PLUG, NP 2.5MM G, B12B-EH-F1A
P809B	23713763	PLUG, NP 2.5MM G, B12B-EH-F1A
P810A	23713759	PLUG, 8P 2.5MM G, B8B-EH-F1-TV4
P810B	23713759	PLUG, 8P 2.5MM G, B8B-EH-F1-TV4
P860	23713942	CONNECTOR, CONNECT B10B-PH-K-S(LF)
P861	23713942	CONNECTOR, CONNECT B10B-PH-K-S(LF)
PG01	23165495	TERMINAL, EARTH PHI3 MET31-0332
PG03	23165495	TERMINAL, EARTH PHI3 MET31-0332
PH01	23165460	TERMINAL, SINGLE ISA01-A
PH02	23165460	TERMINAL, SINGLE ISA01-A

Signal (Scaler) Board - Service part Number

Series	Model	PANEL	Part Number (Service)	OPT1	OPT2	OPT3	OPT4
WL56	32WL56P(B)	SHP-32	23587821	35	00	0A	25
		AUO-32	23590399			0A	45
	32WL56P(G)	SHP-32	23587821			00	25
		AUO-32	23590400			00	45
	37WL56P(B)	LPL-37	23587823			0A	16
		AUO-37	23590401			0A	46
	37WL56P(G)	LPL-37	23587823			00	16
		AUO-37	23590402			00	46
	27WL56P(B)	CMO-27	23587825			0A	34
	27WL56P(G)	CMO-27	23587825			00	34
WL/WLT58	32WL58P(B)	SHP-32	23587827	71	00	0A	25
		LPL-32	23590403			0A	15
	32WL58P(G)	SHP-32	23587827			00	25
		LPL-32	23590404			00	15
	37WL58P(B)	SHP-37	23587829			0A	26
		LPL-37	23590405			0A	16
	37WL58P(G)	SHP-37	23587829			00	26
		LPL-37	23590406			00	16
	42WL58P(B)	LPL-42	23587831			0A	17
	42WL58P(G)	LPL-42	23587831			00	17
	32WLT58	SHP-32	23587833			2A	25
		LPL-32	23590407			2A	15
	37WLT58	SHP-37	23587834			2A	26
		LPL-37	23590408			2A	16
42WLT58	LPL-42	23587835	2A	17			

Key to Panel Type:

SHP= Sharp
 AUO=AUO
 LPL=LG Philips
 CMO=Chi Mei

Location No.	Parts No.	Description
PH03	23165460	TERMINAL, SINGLE ISA01-A
PJ21A	23713934	CONNECTOR, 2MM 3P S WHT B3B-PH-K-S(LF)
PJ22	23757180	CONNECTOR, FH12-50S-0.5SV(55)
PJ22A	23757176	CONNECTOR, IRS 9637S-50Y902 GLD
PJ41	23713943	CONNECTOR, CONNECT B11B-PH-K-S(LF)
PJ41A	23713943	CONNECTOR, CONNECT B11B-PH-K-S(LF)
PJ42	23713939	CONNECTOR, CONNECT B6B-PH-K-S(LF)
PJ42C	23713948	CONNECTOR, CONNECT S6B-PH-K-S(LF)
PJ60	23757180	CONNECTOR, FH12-50S-0.5SV(55)
PJ60A	23757176	CONNECTOR, IRS 9637S-50Y902 GLD
PJ610	23713819	SOCKET, TWG-P23X-A1
PJ930	23713574	CONNECTOR, 7P TOPTYPE BM07B-SRSS-TBT(LF)
PL101	23713755	PLUG, 4P 2.5MM G, B4B-EH-F1-TV4
PL106	23713758	PLUG, 7P 2.5MM G, B7B-EH-F1-TV4
PL201	23713754	PLUG, 3P 2.5MM G, B3B-EH-F1-TV4
PL202	23713754	PLUG, 3P 2.5MM G, B3B-EH-F1-TV4
PP01	#1 23845859	HOLDER, WIRE, PVC-C0AT, L=70MM
PP02	23974994	BAND, KESSOKU
PP07	23528292	HOLDER, ABMM-A-D, (NO SERVICE)
PP08	23974994	BAND, KESSOKU
PP12	23974994	BAND, KESSOKU
PP30	23748087	WASHER, WASHER 10X4.2XT0.3TPO
PS01	23023440	JACK, PIN RA 2P SMK LPR8021-0110F
PS02	23023440	JACK, PIN RA 2P SMK LPR8021-0110F
PV01	23023271	JACK, PIN 6/6P JALCO, YKC21-4673N
PV02	23023272	JACK, PIN 2P YKC21-4112N
PV25A	23713944	CONNECTOR, CONNECT B12B-PH-K-S(LF)
PV60	23365275	JACK, PHONO 3P V-L-R YKC21
PV61	23023300	JACK, Y/C YKF51-5560
PV90	23713710	SOCKET, D-SUB 15P, KR-8622
SA011	23344505	SWITCH, PUSH 1C1P
SA021	23344505	SWITCH, PUSH 1C1P
SA031	23344505	SWITCH, PUSH 1C1P
SA041	23344505	SWITCH, PUSH 1C1P
SA051	23344505	SWITCH, PUSH 1C1P
SA061	23344505	SWITCH, PUSH 1C1P
SA071	23344505	SWITCH, PUSH 1C1P
SA081	23344505	SWITCH, PUSH 1C1P
△ SR80	23146588	RELAY, DLS5D1-O(M) 0.15W
△ SR81	23146584	RELAY, DC12V, TV5, DG-3
W661	23351321	SPEAKER, ASSY, 6X12+TW 8-OHM 10 SPK-1469AO
X501	23153612	CRYSTAL, 16.200 25PPM 25OHM
XD02	23153504	CERAMIC RESONATOR, 8.00MHZ 25OHM
PC BOARD ASSEMBLIES		
* U001	PD2238A1	SIGNAL (scaler) see previous page
* U002A	75001532	PC BOARD ASSY, POWER PD2171A1
* U002B	75001533	PC BOARD ASSY, AC IN PD2171A2
* U003A	75001735	PC BOARD ASSY, PD2172B1 TN AV
* U003B	75001736	PC BOARD ASSY, PD2172B2 FRONT AV
* U003C	75001739	PC BOARD ASSY, PD2172B3 RMT LED
* U003E	75001741	PC BOARD ASSY, PD2172B5 PC HDMI
* U003F	75001743	PC BOARD ASSY, PD2172B6 KEY
* U004	75001771	PC BOARD ASSY, PD2173D1 LOW B
* U005	75001745	PC BOARD ASSY, PD2174A1 INTER FACE
* B002	23148448	DVB T MODULE, 16PING08
TUNER		
H001	23321550	TUNER, TIF EU HOR 61 IEC PAL+L ENGF7304GF
ACCESSORIES		
A701	#1 23015116	CARTON, CASE
A701A	#2 23015120	CARTON, TOP CASE
A701B	#2 23015121	CARTON, BOTTOM CASE
A702A	#1 23580007	PACKING, TOP PACKING
	#2 23580010	PACKING, TOP PACKING
A702B	#1 23580008	PACKING, BOTTOM PACKING
	#2 23580011	PACKING, BOTTOM PACKING
A705	#2 23518043	PACKING, JOINT, 3Z25P
△ Y101	23566748	OWNERS MANUAL, ENGLISH 32WLT58;ENG
Y130	23306637	REMOCON HAND UNIT IR, DTVPAL CT-90240
Y170	23845800	HOLDER, WIRE, NYLON66 D6.8
CABINET PARTS		
A201	#1 23533631	COVER, FRONT BEZEL ASSY
	#2 23533645	COVER, FRONT BEZEL ASSY
A315	#1 23533456	COVER, BACK CENTER COVER

Location No.	Parts No.	Description
	#2 23533483	COVER, BACK CENTER COVER
A320	23940438	PIECE, FRONT AV ASSY
A340	23940522	PIECE CONTROL HOLDER ASSY
△ A401	#1 23533452	COVER, BACK COVER
△	#2 23533479	COVER, BACK COVER ASSY
A420	#1 23436880	FOOT, STAND ASSY
	#2 23436882	FOOT, STAND ASSY
A445	#1 23533889	COVER, CABLE COVER BOTTOM ASSY
	#2 23533960	COVER, BC BOTTOM COVER
A450	#1 23533454	COVER, CABLE COVER SIDE
	#2 23533481	COVER, BC SIDE COER

POWER BOARD PD2171A1 (U002A)
BOTTOM (FOIL) SIDE

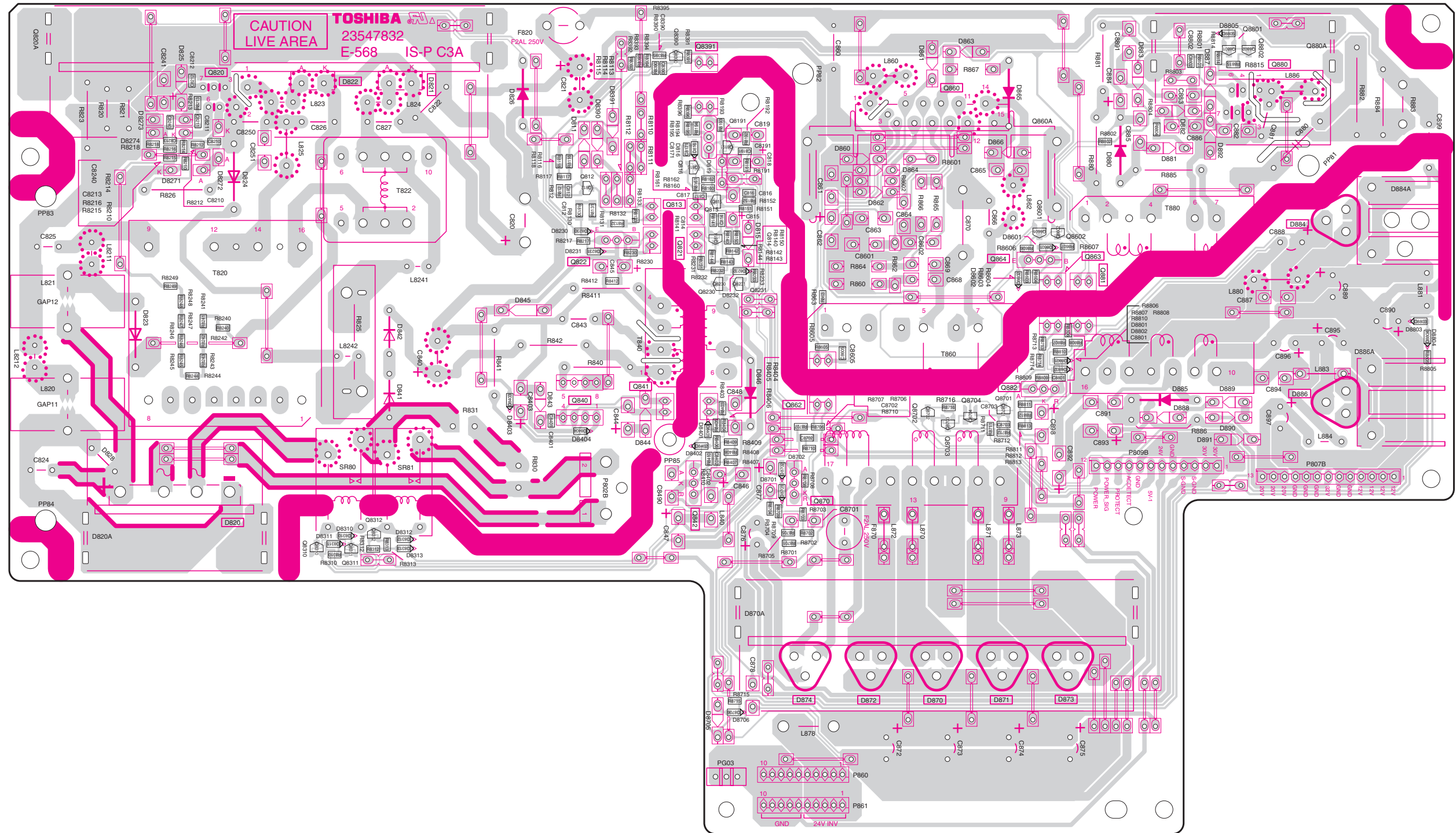

TN AV BOARD PD2172B1 (U003A)
BOTTOM (FOIL) SIDE

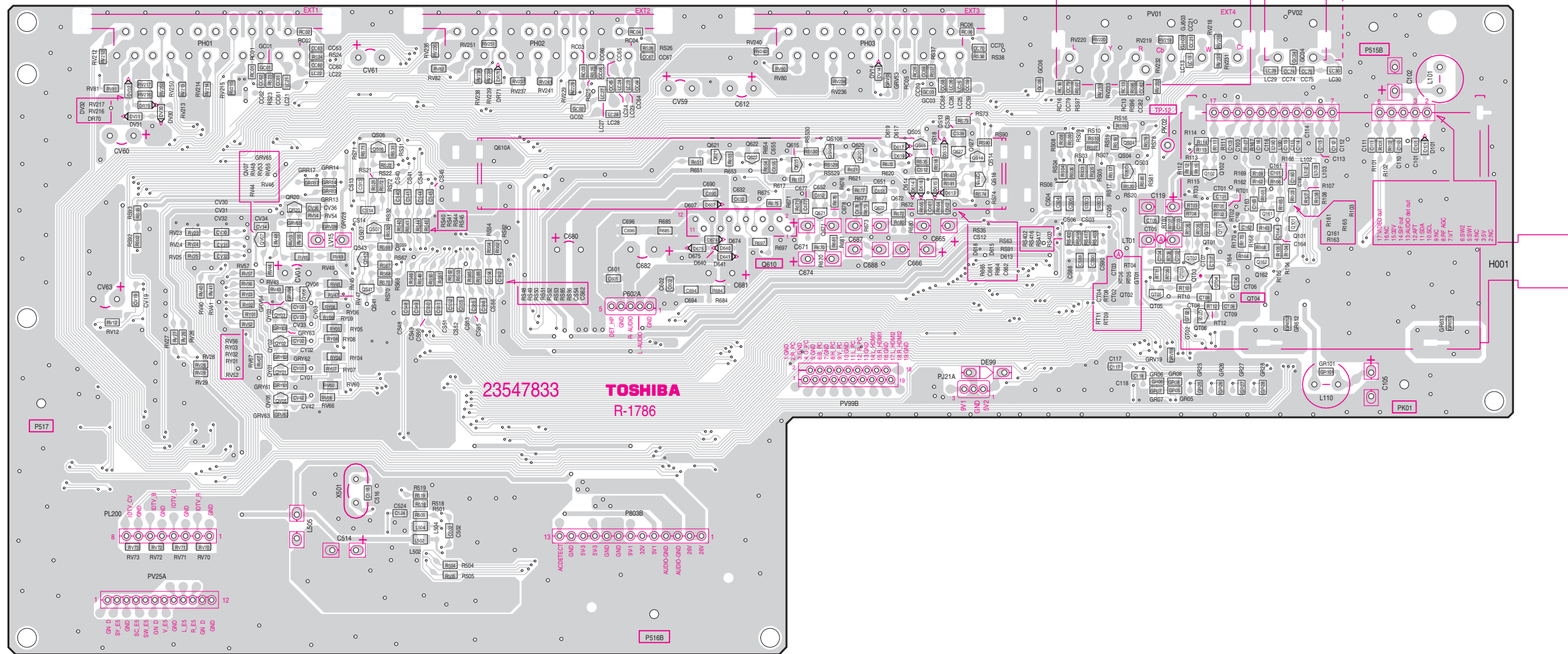

INTERFACE BOARD PD2174A1 (U005)
BOTTOM (FOIL) SIDE

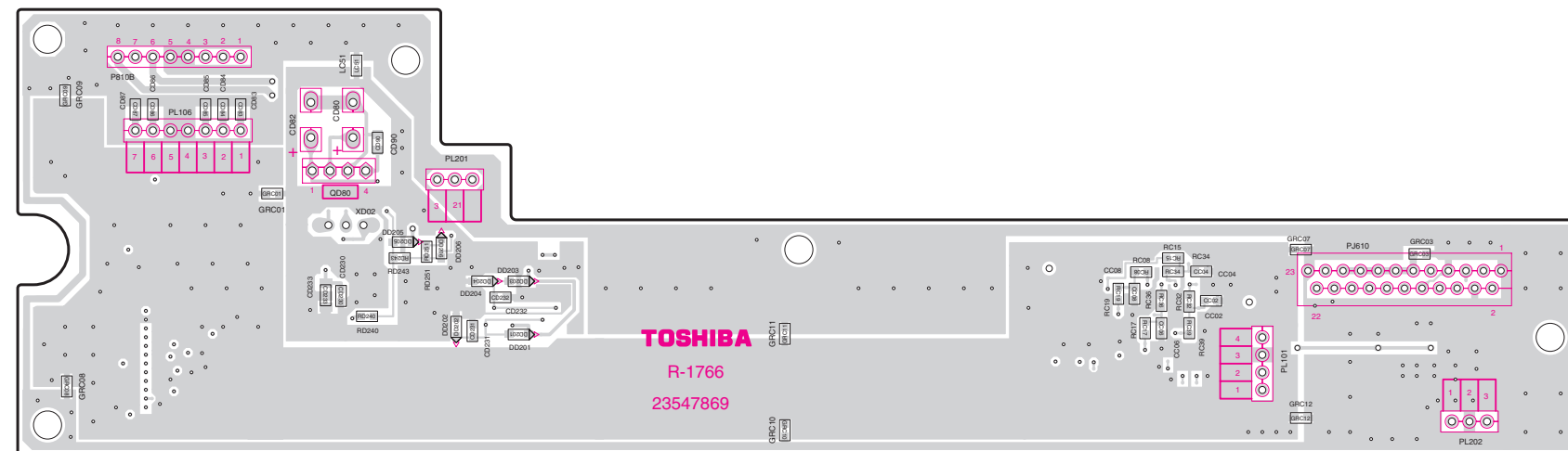

TN AV BOARD PD2172B1 (U003A)
 TOP (COMPONENT) SIDE

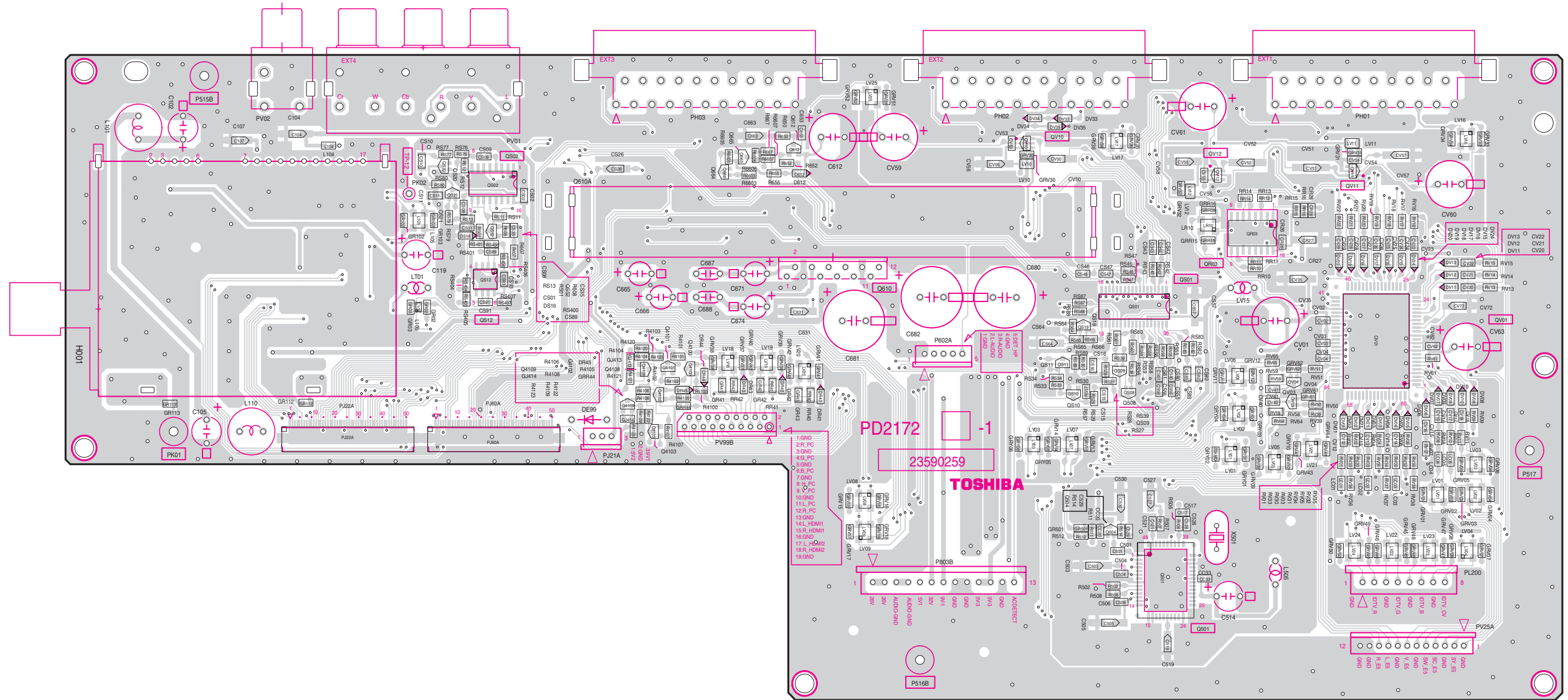

INTERFACE BOARD PD2174A1 (U005)
 TOP (COMPONENT) SIDE

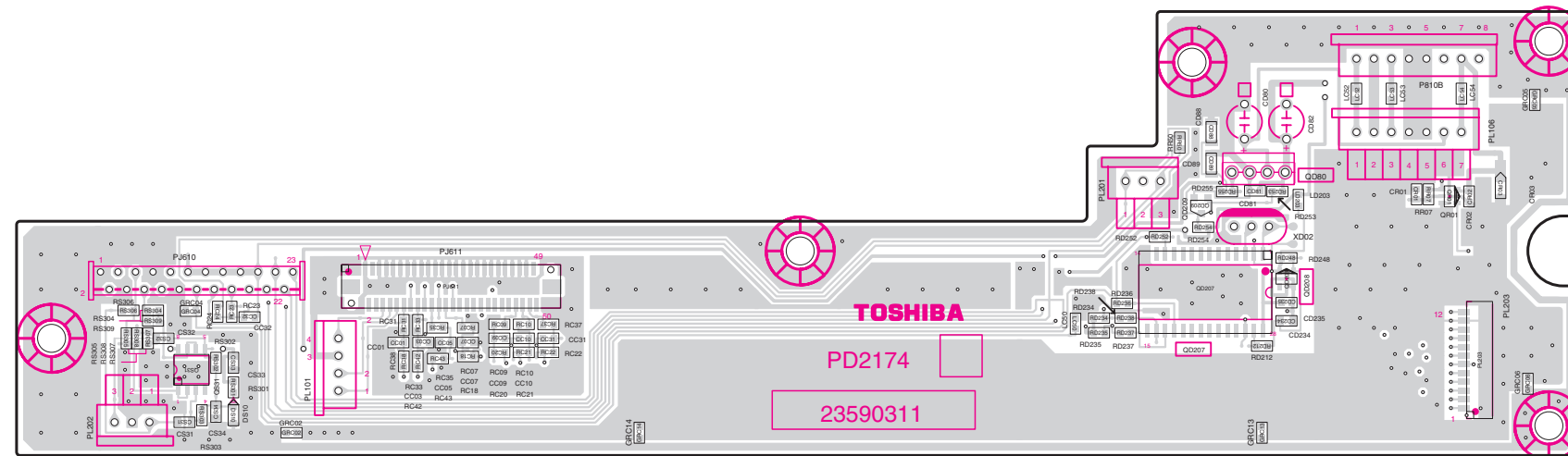

FRONT AV BOARD PD2172B2 (U003B)
BOTTOM (FOIL) SIDE

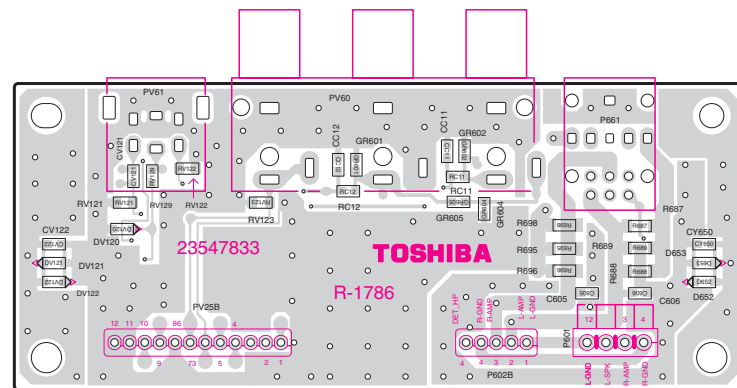

FRONT AV BOARD PD2172B2 (U003B)
TOP (COMPONENT) SIDE

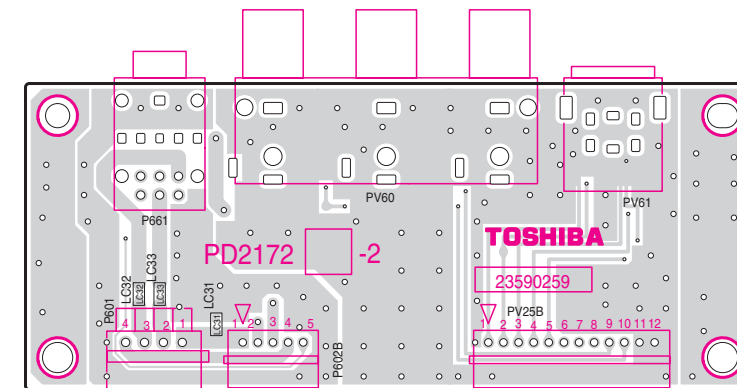

RMT LED BOARD PD2172B3 (U003C)
BOTTOM (FOIL) SIDE

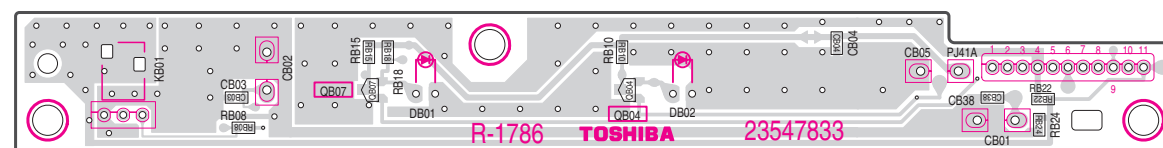

RMT LED BOARD PD2172B3 (U003C)
TOP (COMPONENT) SIDE

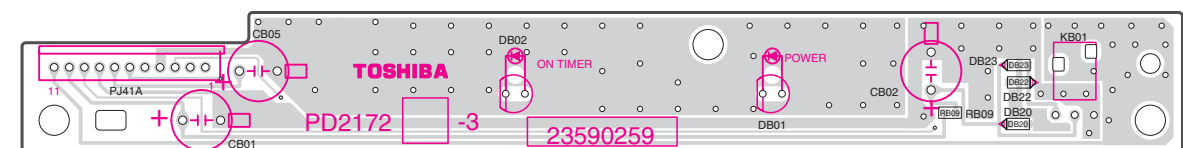

PC HDMI BOARD PD2172B5 (U003E)
BOTTOM (FOIL) SIDE

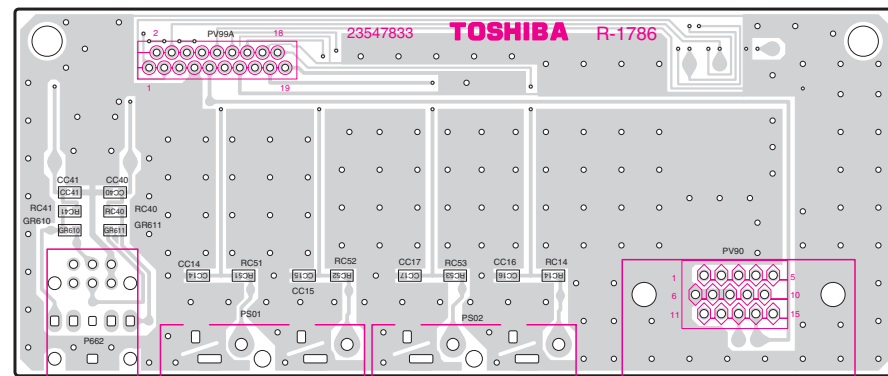

PC HDMI BOARD PD2172B5 (U003E)
TOP (COMPONENT) SIDE

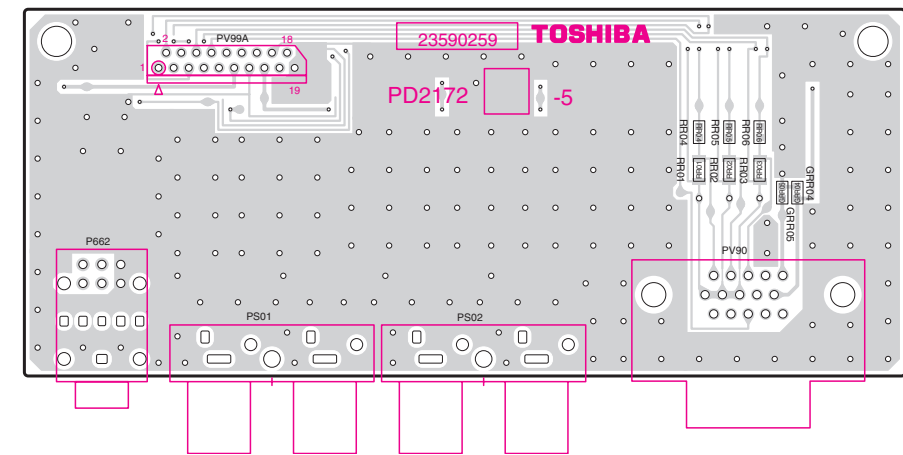

KEY BOARD PD2172B6 (U003F)
BOTTOM (FOIL) SIDE

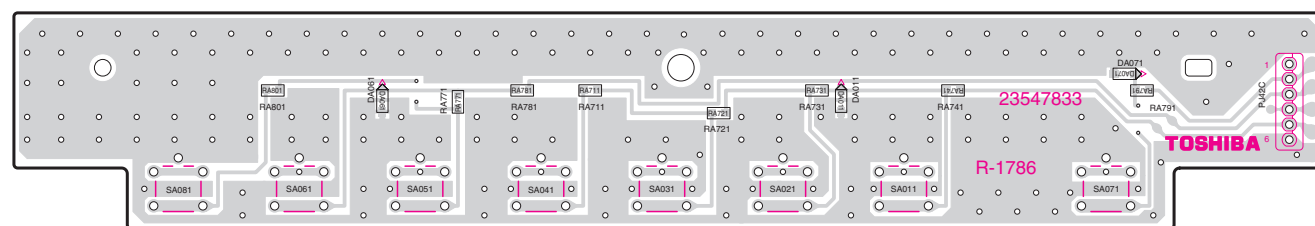

KEY BOARD PD2172B6 (U003F)
TOP (COMPONENT) SIDE

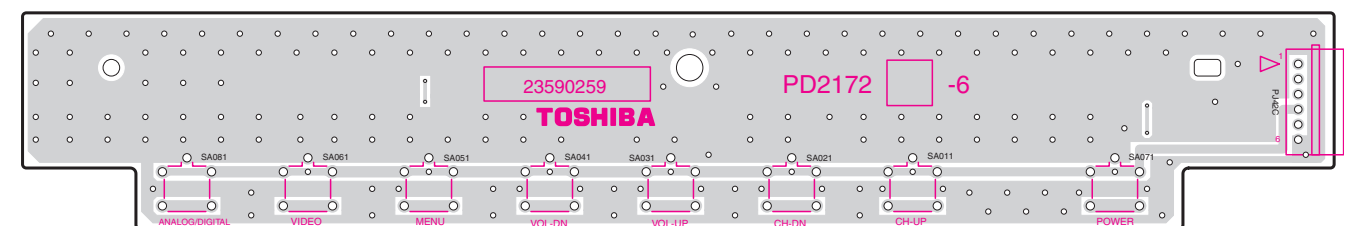

AC IN BOARD PD2171A2 (U002B)
BOTTOM (FOIL) SIDE

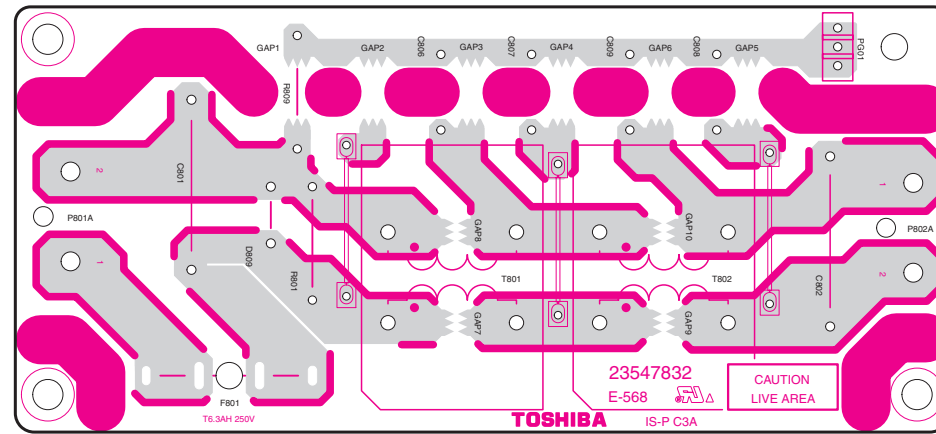

LOW B BOARD PD2173D1 (U004)
BOTTOM (FOIL) SIDE

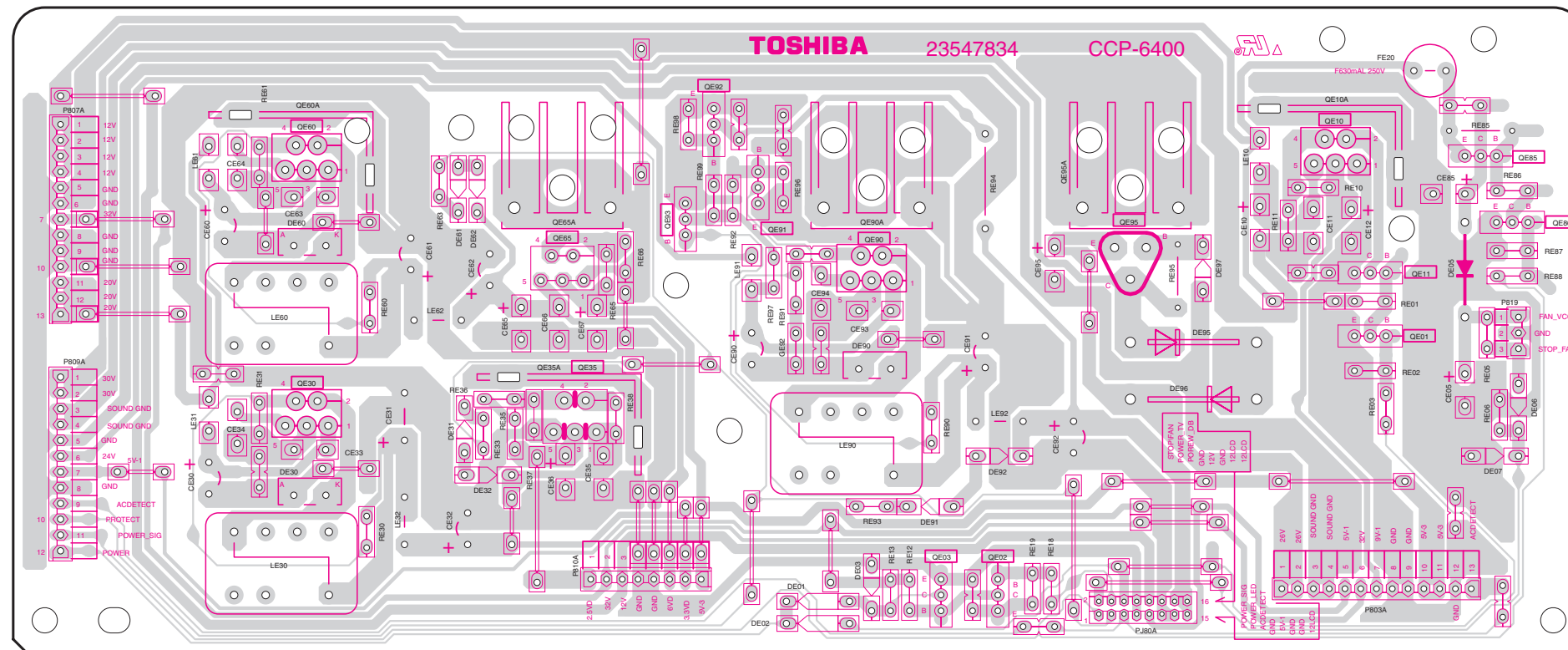

SIGNAL BOARD PD2238A1 (U001)
BOTTOM (FOIL SIDE)

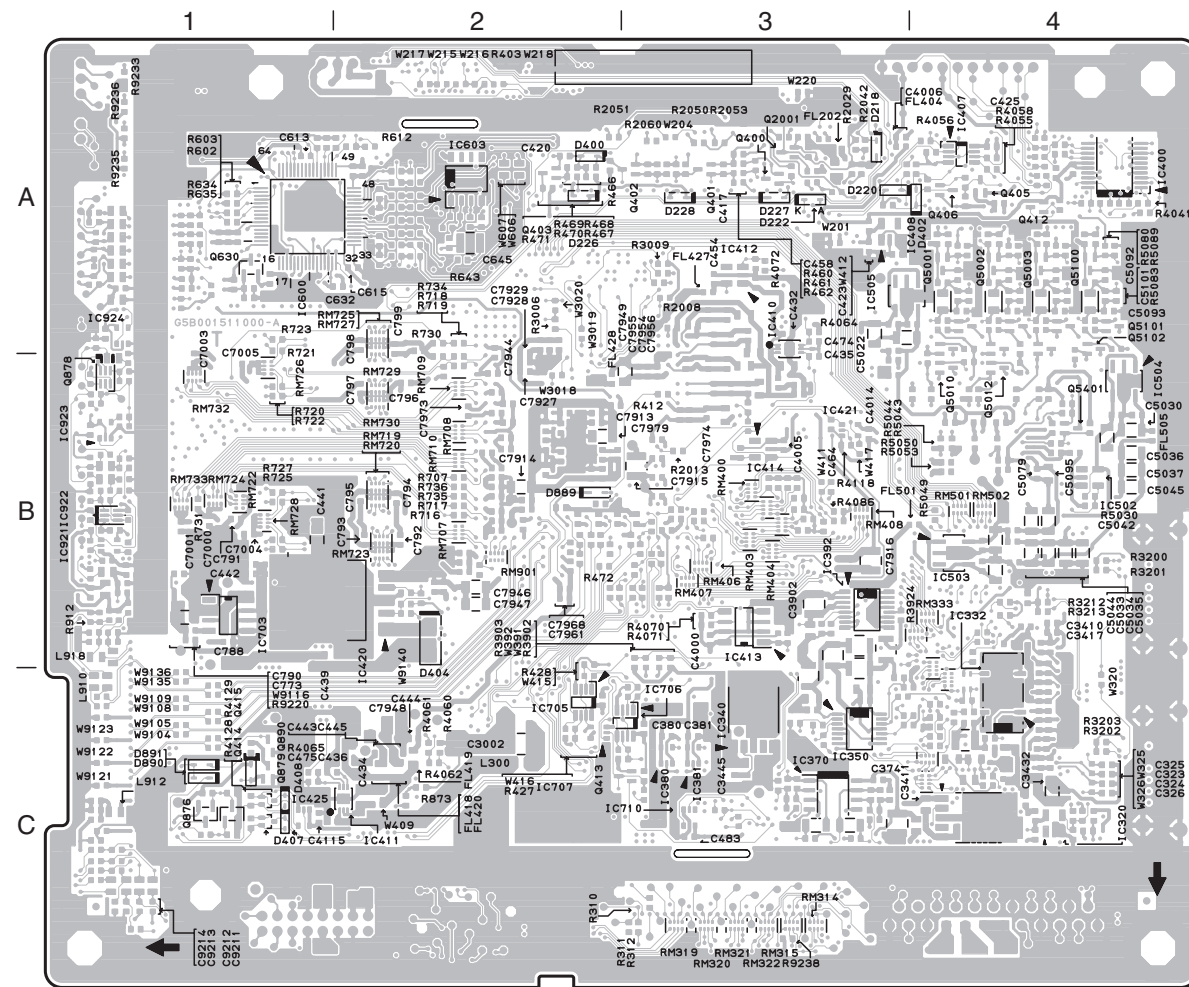

SIGNAL BOARD PD2238A1 (U001)
TOP (COMPONENT) SIDE

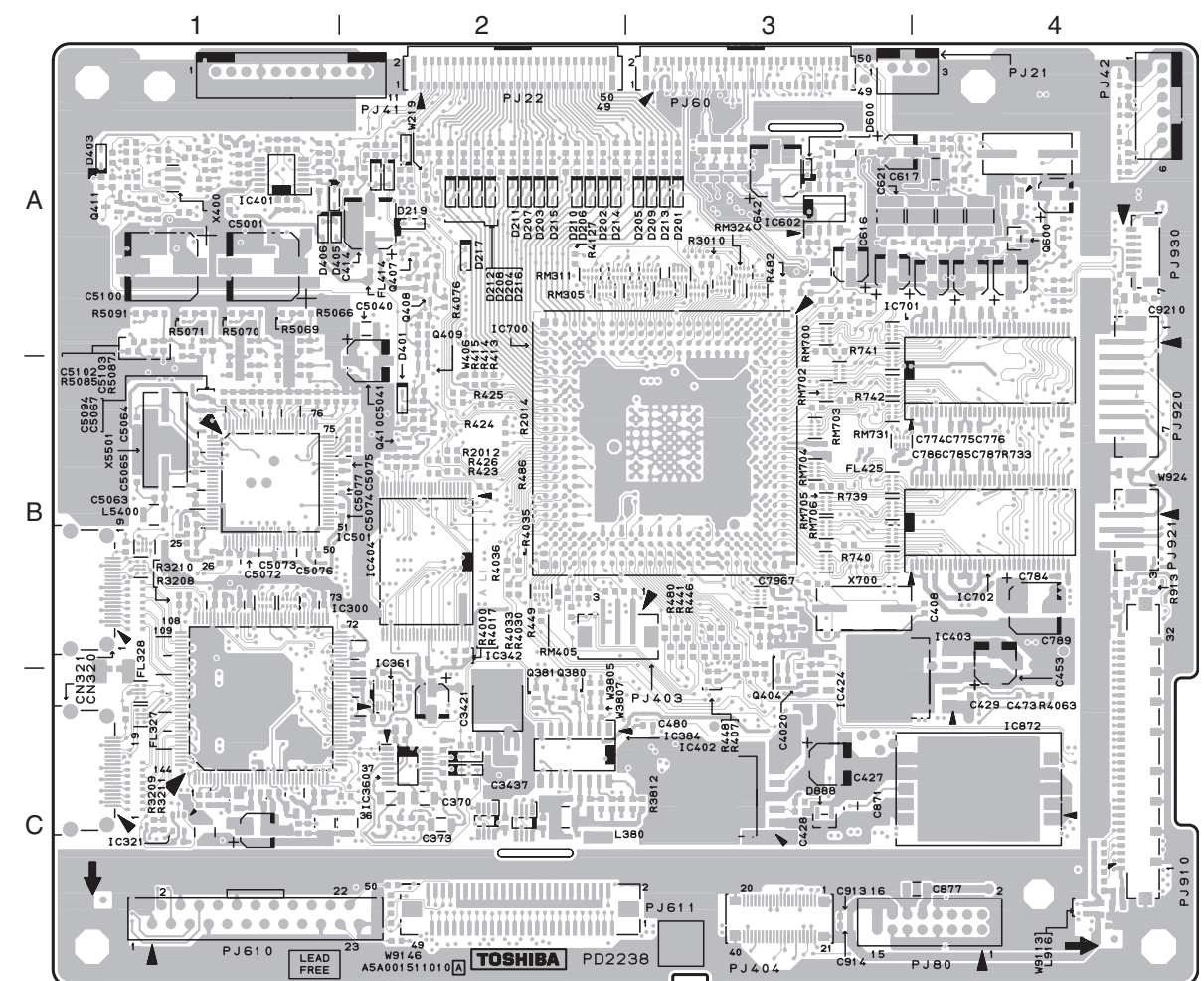



SCHEMATIC DIAGRAM

MODEL : 32WLT58/37WLT58

WARNING: BEFORE SERVICING THIS CHASSIS, READ THE "SERVICE SAFETY PRECAUTIONS" ON PAGE 3 OF THIS MANUAL.

CAUTION: The international hazard symbols " \triangle " in the schematic diagram and the parts list designate components which have special characteristics important for safety and should be replaced only with types identical to those in the original circuit or specified in the parts list. The mounting position of replacements is to be identical with originals. Before replacing any of these components, read carefully the PRODUCT SAFETY NOTICE on the MANUAL for this model. Do not degrade the safety of the receiver through improper servicing.

NOTE:

- RESISTOR** Resistance is shown in ohm [K = 1.000, M = 1.000.000]. All resistors are 1/6W and 5% tolerance carbon resistor, unless otherwise noted as the following marks.
1/2R = Metal or Metal oxide of 1/2 watt 1/2S = Carbon composition of 1/2 watt
1RF = Fuse resistor of 1 watt 10W = Cement of 10 watt
K = $\pm 10\%$ G = $\pm 2\%$ F = $\pm 1\%$
- CAPACITOR** Unless otherwise noted in schematic, all capacitor values less than 1 are expressed in F, and the values more than 1 in pF.
All capacitors are ceramic 50V, unless otherwise noted as the following marks.
 Electrolytic capacitor  Mylar capacitor
- The parts indicated with " \triangle " have special characteristics, and should be replaced with identical parts only.
- Voltages read with DIGITAL MULTI-METER from point indicated to chassis ground, using a color bar signal with all controls at normal, line voltage at 220 volts.
- Waveforms are taken receiving color bar signal with enough sensitivity.
- Voltage reading shown are nominal values and may vary $\pm 20\%$ except H.V.

■ SCHEMATIC DIAGRAM STRUCTURE:

AC INPUT Circuit		1/66
INTERFACE Circuit		2/66
LOW_B Circuit	CONNECTOR [SHEET-1/2]	3/66
	LOWB [SHEET-2/2]	4/66
PC-HDMI-IN Circuit		5/66
POWER Circuit	CONNECTOR [SHEET-1/7]	6/66
	RELAY/RUSH PROTECTION [SHEET-2/7]	7/66
	PFC [SHEET-3/7]	8/66
	STANDBY POWER [SHEET-4/7]	9/66
	RCC POWER [SHEET-5/7]	10/66
	RESONANCE POWER [SHEET-6/7]	11/66
	PROTECT/ AC DETECT [SHEET-7/7]	12/66
LED RMT Circuit		13/66
TN_AV Circuit	CONNECTOR [SHEET-1/11]	14/66
	VIDEO-SW [SHEET-2/11]	15/66
	TIF [SHEET-3/11]	16/66
	AV-TERMINAL [SHEET-4/11]	17/66
	AUDIO-SW [SHEET-5/11]	18/66
	A-OUT [SHEET-6/11]	19/66
	AUDIO MUTE [SHEET-7/11]	20/66
	RGB_SW [SHEET-8/11]	21/66
	TEXT SW [SHEET-9/11]	22/66
	TV-OUT [SHEET-10/11]	23/66
	VIDEO CHROMA [SHEET-11/11]	24/66
FRONT-AV Circuit		25/66
KEY Circuit		26/66
SIGNAL Circuit	ANALOG_IN [SHEET-200]	27/66
	PIP VCD [SHEET-206]	28/66
	REG/RESET [SHEET-207]	29/66
	INPUT LPF [SHEET-208]	30/66
	FUNCTION [SHEET-209]	31/66
	D_IN_A [SHEET-300]	32/66
	D_IN_B [SHEET-301]	33/66
	HDMI (LINC, I2C) [SHEET-302]	34/66
	HDMI Rx#2 (Video/Audio) [SHEET-303]	35/66
	HDMI Rx#3 (PWR,Audio) [SHEET-304]	36/66
	HDMI AUDIO PLL [SHEET-305]	37/66
	HDMI AUDIO DAC [SHEET-306]	38/66
	HDMI AUDIO OUT [SHEET-307]	39/66
	HDMI CONTROLLER [SHEET-308]	40/66
	EEPROM1 [SHEET-309]	41/66
	EEPROM2 [SHEET-310]	42/66
	MICRO I/O [SHEET-400]	43/66
	OCM MEMORY I/F [SHEET-401]	44/66
	FLASH MEMORY [SHEET-402]	45/66
	SYNC SEPA [SHEET-403]	46/66
	E2P OTHER [SHEET-404]	47/66
	STD-BY MICRO [SHEET-405]	48/66
	CORTEZ REG 1 [SHEET-406]	49/66
	CORTEZ REG 2 [SHEET-407]	50/66
	CORTEZ REG 3 [SHEET-408]	51/66
	BOOT CONFIG [SHEET-409]	52/66
	SERVICE CONNECTOR [SHEET-410]	53/66
	I2C Switch [SHEET-411]	54/66
	AUDIO (1/2) [SHEET-600]	55/66
	AUDIO (2/2) [SHEET-601]	56/66
	CORTEZ 1 [SHEET-700]	57/66
	CORTEZ 2 [SHEET-701]	58/66
	DDR I/F [SHEET-702]	59/66
	DDR SDRAM [SHEET-703]	60/66
	DDR TERMINATION [SHEET-704]	61/66
	DCDC CONV. [SHEET-802]	62/66
	LVDS OUT [SHEET-900]	63/66
	LVDS OUT(SHARP LCD) [SHEET-901]	64/66
	Power Connector and Dimming [SHEET-902]	65/66
	LVDS Power and Others [SHEET-903]	66/66

CIRCUIT BLOCK DIAGRAM

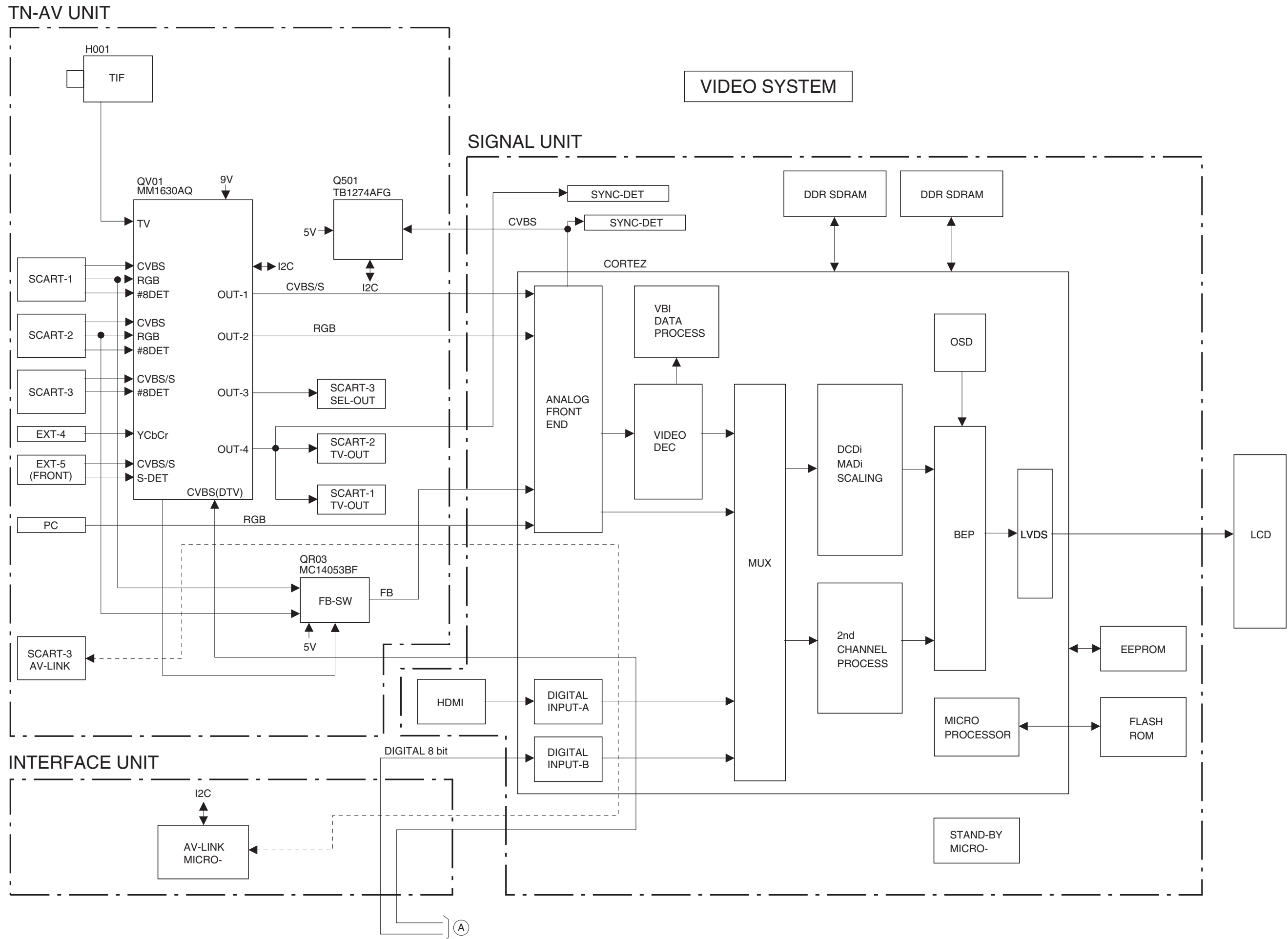

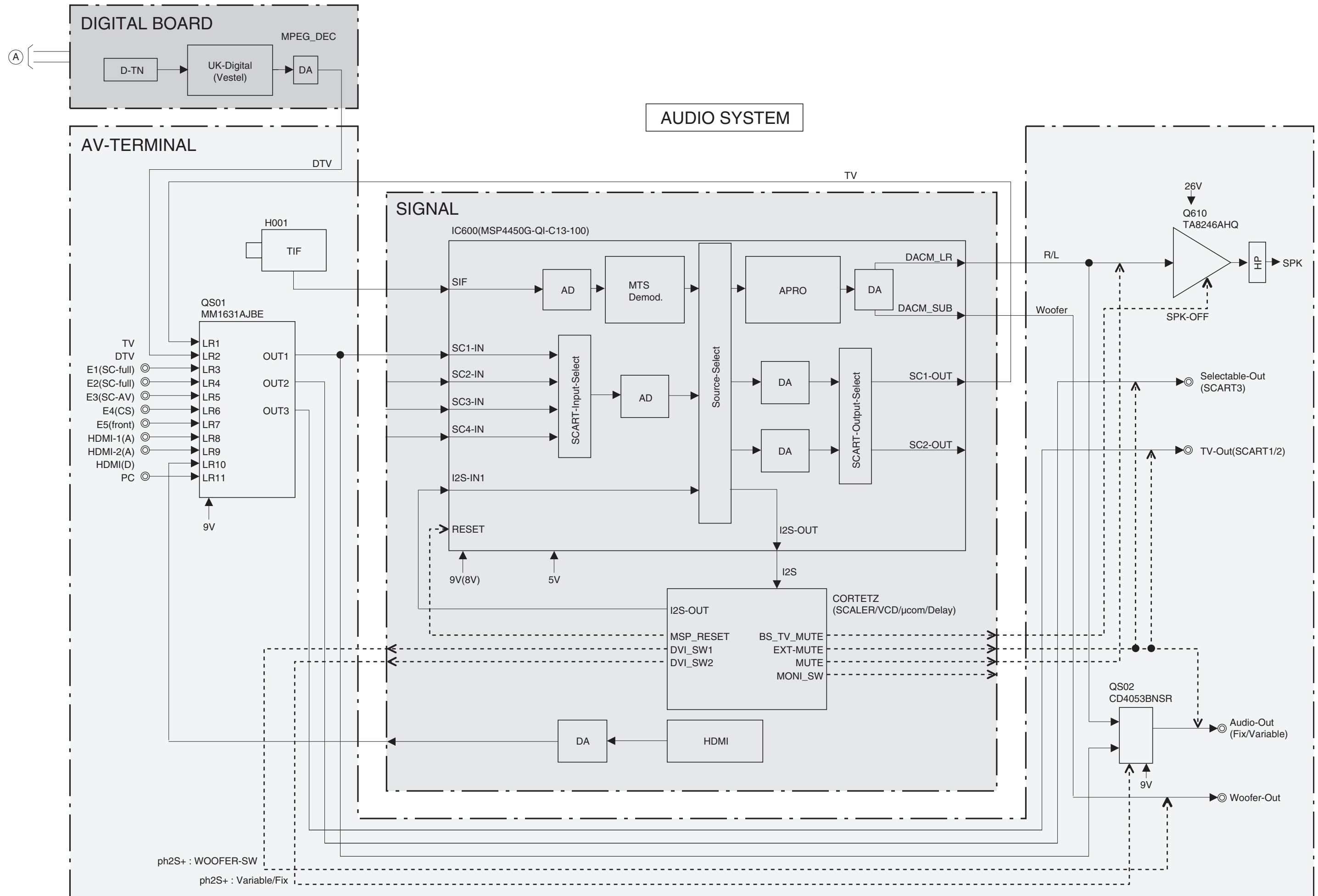

SPECIFICATIONS

Broadcast systems/channels

PAL-I	UHFK21-UK69
PAL-B/G	UHFE21-E69 VHFE2-E12, S1-S41
SECAM-L	UHFF21-F69 VHFF1-F10, B-Q
SECAM-D/K	HFR21-R69 VHFR1-R12

Video Input PAL, SECAM, NTSC 3.58/4.43

External connections

EXT1	Input	21-pin SCART	RGB, A/V
EXT2	Input	21-pin SCART	RGB, A/V
EXT3	Input/Output	21-pin SCART	A/V S-video Selectable output
EXT4	Input	Phono jacks Phono jacks	Y, P _B /C _B , P _R /C _R A/V
EXT5	Input (Side)	4 pin Phono jack Phono jacks	S-video Video Audio L + R
HDMI	Input	HDMI connector	Digital television and audio signal
	Input	Phono jacks	Audio L + R
PC	Input	Mini D-sub 15-pin	Analog RGB signal
	Input	3.5mm stereo jack	Audio
Audio Output Fixed/Variable		Phono jacks	Audio L + R
Output to Active Super Woofer		Phono socket	

Programme Positions 100

Stereo Nicam
2 carrier system

Visible Screen Size (approx.) 32WLT 80cm
37WLT 94cm

Display 16:9

Sound output (at 10% distortion) Main 10W + 10W

Power consumption 32WLT 170W
as specified in EN60107-1 : 1997 37WLT 195W

Standby (approx.) 32WLT <0.5W
37WLT <0.5W

Dimensions (approx.) 32WLT 60cm (H) 80cm (W) 30cm (D)
37WLT 67cm (H) 91cm (W) 32cm (D)
(Height dimension includes foot stand)

Weight (approx.) 32WLT 22kg
37WLT 26kg

Headphone socket 3.5mm stereo

Accessories Remote control
2 batteries
(AAA, IEC R03 1.5V)

TOSHIBA CORPORATION
1-1, SHIBAURA 1-CHOME, MINATO-KU, TOKYO 105-8001, JAPAN