



## 3414

## LINEAR INTEGRATED CIRCUIT

### SINGLE-SUPPLY DUAL HIGH CURRENT OPERATIONAL AMPLIFIER

#### DESCRIPTION

The UTC **3414** integrated circuit is a high gain, high output current, high output voltage swing dual operational amplifier capable of driving 70mA.

#### FEATURES

- \* Single supply
- \* Operating voltage: 3V~15V
- \* High output current: 70Ma
- \* Slew rate: 10V/μA(Typ.)
- \* Bipolar technology

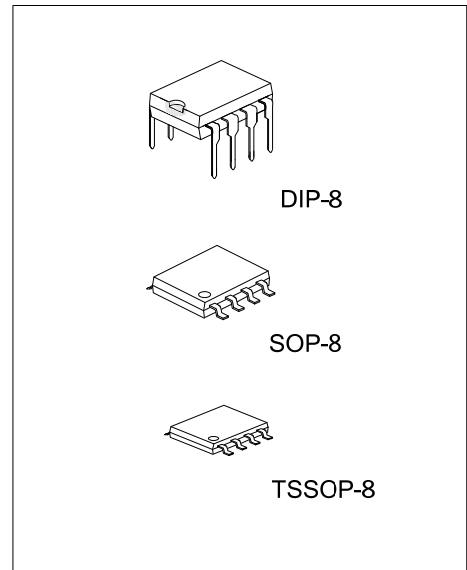

#### ORDERING INFORMATION

Ordering Number	Package	Packing
3414G-D08-T	DIP-8	Tube
3414G-P08-R	TSSOP-8	Tape Reel
3414G-S08-R	SOP-8	Tape Reel

<p>3414L-D08-T</p> <p>(1)Packing Type</p> <p>(2)Package Type</p> <p>(3)Green Package</p>	<p>(1) T: Tube, R: Tape Reel</p> <p>(2) D08: DIP-8, P08: TSSOP-8, S08: SOP-8</p> <p>(3) L: Lead Free, G: Halogen Free and Lead Free</p>
--	---

#### MARKING

DIP-8	SOP-8	TSSOP-8
<p>UTC □□□□ → Date Code</p> <p>3414 □□ → Lot Code</p> <p>L: Lead Free</p> <p>G: Halogen Free</p>	<p>UTC □□□□ → Date Code</p> <p>3414G □□ → Lot Code</p>	<p>UTC □□□□ → Date Code</p> <p>3414G □□ → Lot Code</p>

## ■ PIN CONFIGURATION

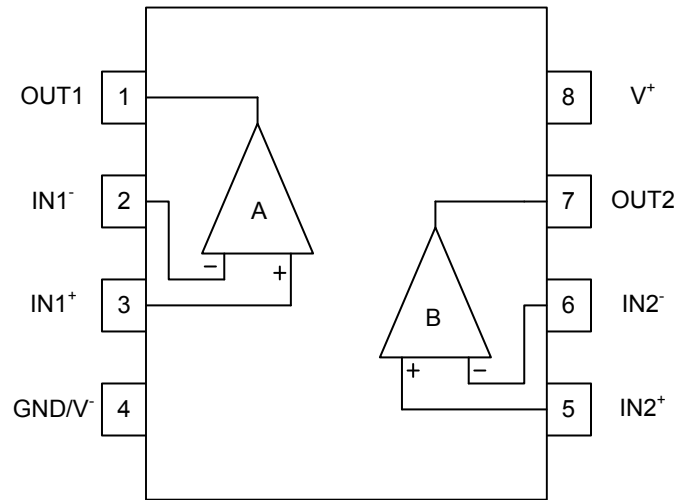

## ■ BLOCK DIAGRAM

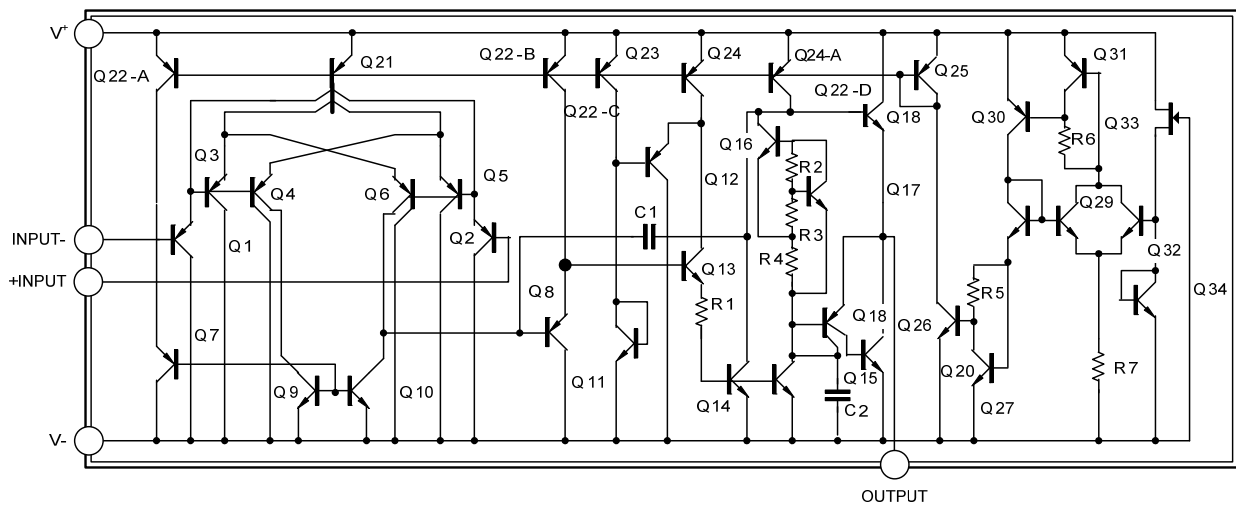

■ ABSOLUTE MAXIMUM RATINGS ( $T_A=25^\circ\text{C}$ )

PARAMETER	SYMBOL	VALUE	UNIT
Supply Voltage	$V^+(V^+/V)$	15V (or $\pm 7.5$ )	V
Differential Input Voltage	$V_{I(DIFF)}$	15	V
Input Voltage	$V_{IN}$	-0.3 ~ +15	V
Power Dissipation	$P_D$	300	mW
Operating Temperature	$T_{OPR}$	-20~+75	$^\circ\text{C}$
Storage Temperature	$T_{STG}$	-40~+125	$^\circ\text{C}$

Note: Absolute maximum ratings are those values beyond which the device could be permanently damaged.

Absolute maximum ratings are stress ratings only and functional device operation is not implied.

■ ELECTRICAL CHARACTERISTICS ( $T_A=25^\circ\text{C}$ ,  $V^+=8.6\text{V}$ )

PARAMETER	SYMBOL	TEST CONDITIONS	MIN	TYP	MAX	UNIT
Input Offset Voltage	$V_{I(OFF)}$	$R_S=0\Omega$		2	5	mV
Input Offset Current	$I_{I(OFF)}$			5	100	nA
Input Bias Current	$I_{I(BIAS)}$			100	500	nA
Large Signal Voltage Gain	$G_V$	$R_L=2\text{k}\Omega$	88	100		dB
Input Common Voltage Range	$V_{ICM}$		$V^+-2$			V
Maximum Output Voltage Swing 1	$V_{OM1}$	$R_L \geq 2\text{k}\Omega, V^+=5\text{V}$	3.5			V
Maximum Output Voltage Swing 2	$V_{OM2}$	$I_{OUT}=70\text{mA}, V^+=5\text{V}$	3.2			V
Common Mode Rejection Ratio	CMR		80	90		dB
Supply Voltage Rejection Ratio	SVR		80	90		dB
Operating Current	$I_{CC}$	$R_L=\infty$	3	4	5	mA
Slew Rate	SR			1.0		V/ $\mu\text{s}$
Unity Gain Bandwidth	GB			1.3		MHz
Operating Voltage Range	$V^+$				15	V

■ TYPICAL CHARACTERISTICS

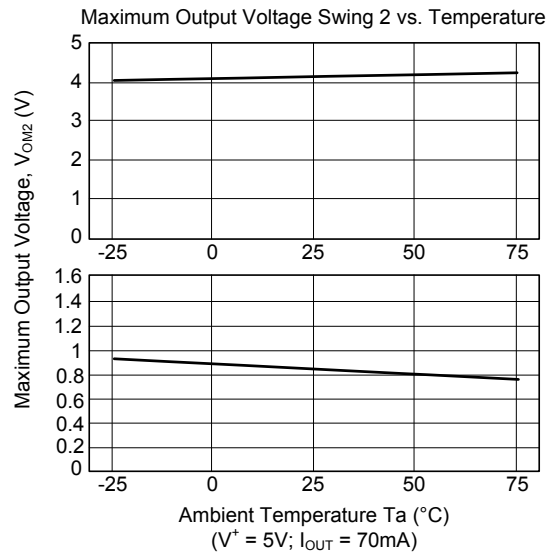
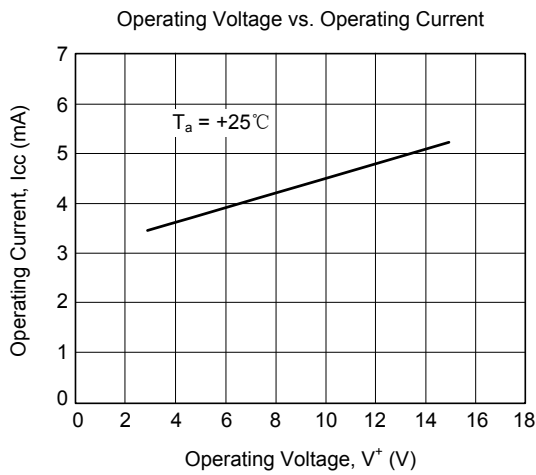
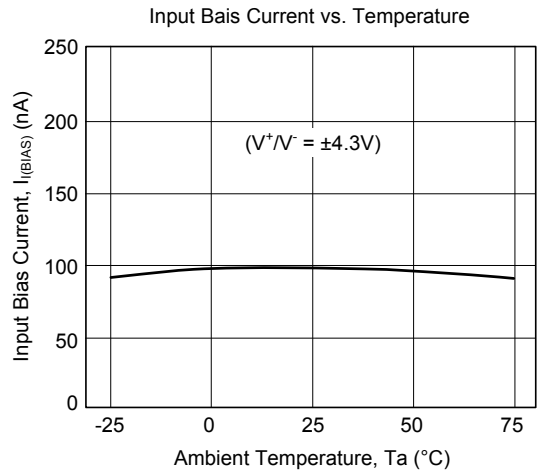
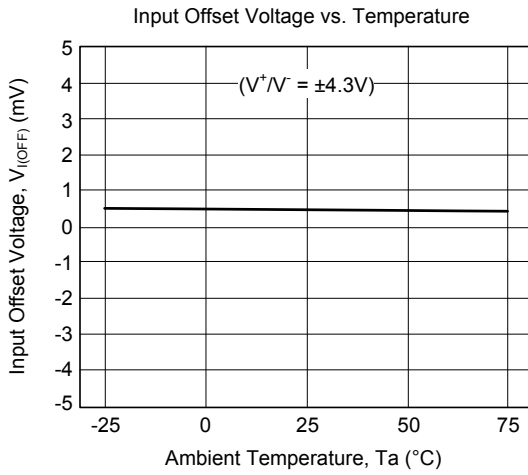
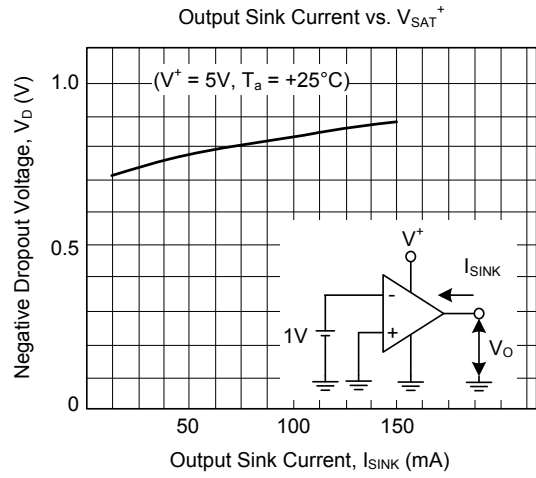
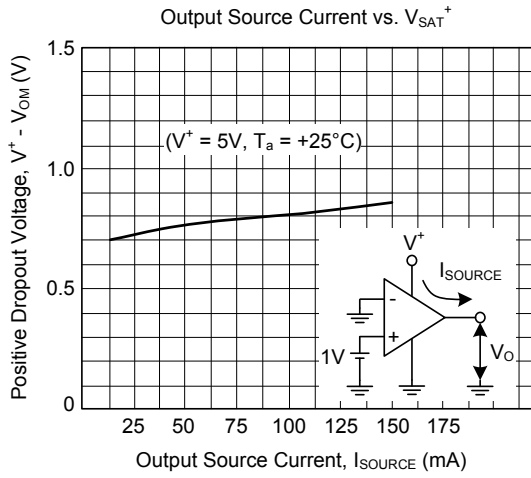

■ TYPICAL CHARACTERISTICS(Cont.)

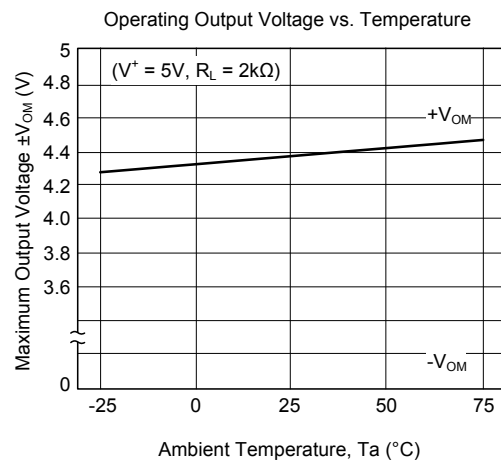
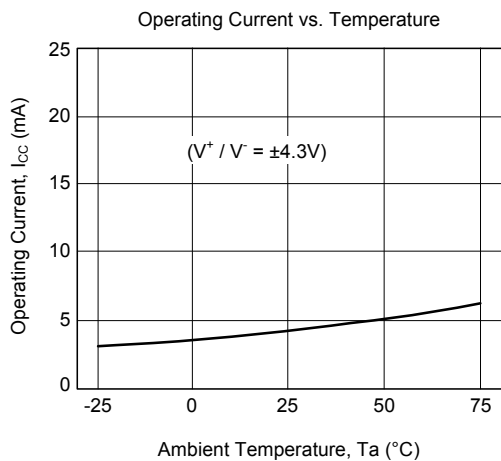
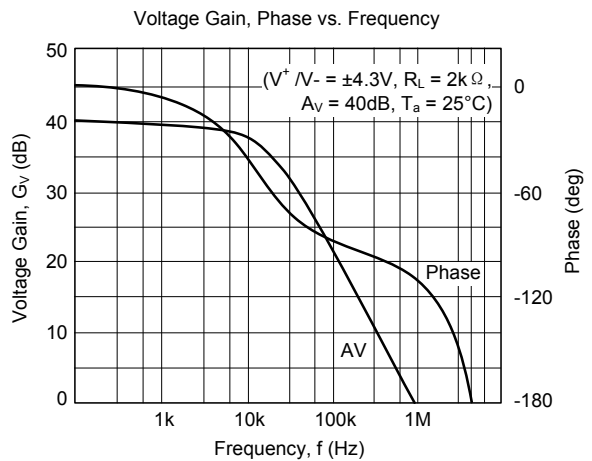
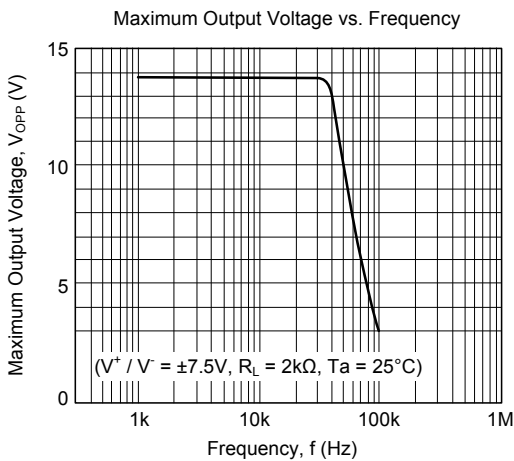
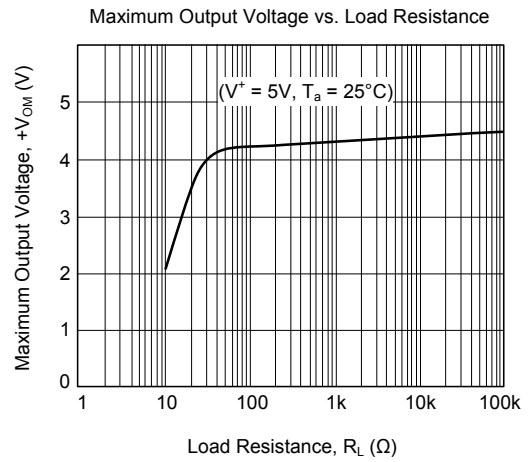
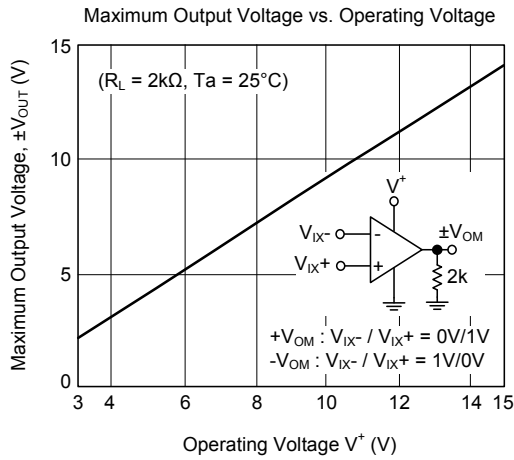

UTC assumes no responsibility for equipment failures that result from using products at values that exceed, even momentarily, rated values (such as maximum ratings, operating condition ranges, or other parameters) listed in products specifications of any and all UTC products described or contained herein. UTC products are not designed for use in life support appliances, devices or systems where malfunction of these products can be reasonably expected to result in personal injury. Reproduction in whole or in part is prohibited without the prior written consent of the copyright owner. The information presented in this document does not form part of any quotation or contract, is believed to be accurate and reliable and may be changed without notice.