

.100" × .100" Latch/Ejector Header

4 Wall, Straight & Right Angle, High Temp Option

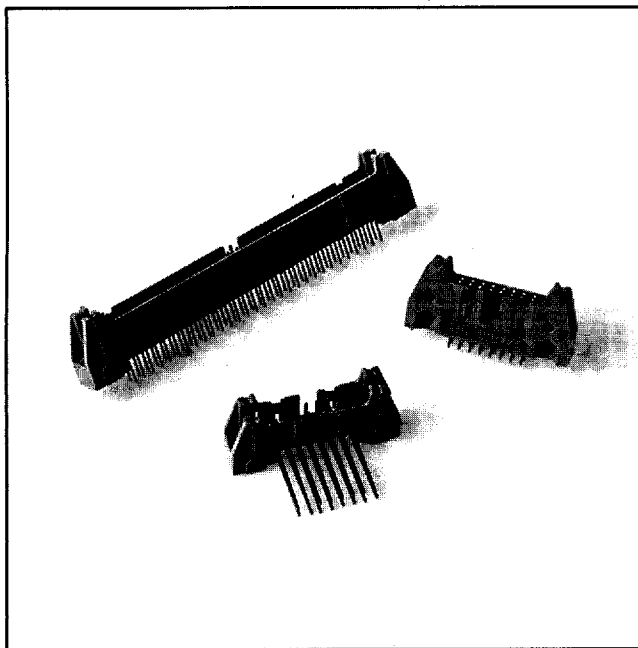

- Military (with 3M's 3518 polarizing key) and centerbump polarization
- Optional ejector latches
- Mounting holes for securing header to board
- Solder tail and wrap tail options
- Optional polarizing posts
- Choice of rolled pin and snap-in latches
- High temperature option

TS-0772-01
Sheet 1 of 4

84

Physical

Insulation

Material: Glass Filled Polyester (PBT)
Glass Filled Polyester (PCT — High Temp Option)

Flammability: UL 94V-0

Color: Gray, Standard
Beige (High Temp Option)

Marking: 3M Logo, Part Identification Number and Orientation Triangle

Contact

Material: Copper Alloy

Plating

Underplate: 100 μ " [2.54 μ m] Nickel — QQ-N-290, Class 2
Wiping Area: Gold — MIL-G-45204, Type II, Grade C
Solder Tails: 200 μ " [5.08 μ m] 60/40 Tin Lead — MIL-P-81728
Wrap Tails: Gold Flash, Standard

Electrical

Current Rating: 1 A

Insulation Resistance: $>1 \times 10^9 \Omega$ at 500 Vdc

Withstanding Voltage: 1000 Vrms at Sea Level

Environmental

Temperature Rating: -55°C to $+105^\circ\text{C}$

High Temp Process Rating: Maximum 235°C , with 90 seconds over 215°C

.100" × .100" Latch/Ejector Header

4 Wall, Straight & Right Angle, High Temp Option

-X0XX
Header with No
Ejector/Latch

-X2XX
-X5XX
Header with
Short Ejector/Latch
for 3M Sockets without
Strain Relief

-X3XX
-X6XX
Header with
Long Ejector/Latch
for 3M Sockets with
Strain Relief

-X4XX
Header with
Ejector only

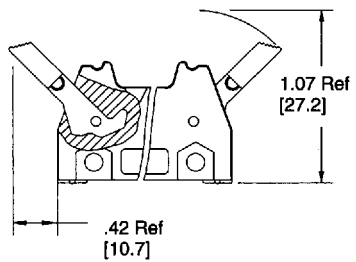
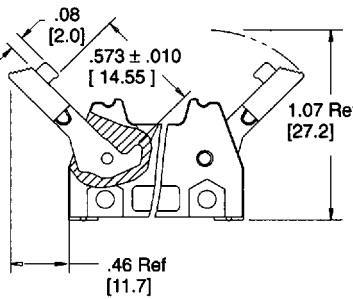
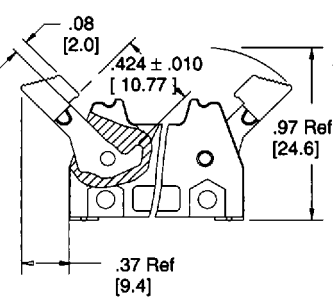
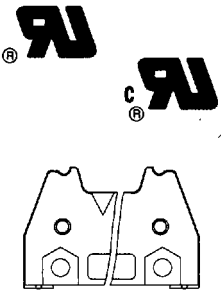

Note: This Ejector is a Nickel Plated Zinc Alloy Casting.

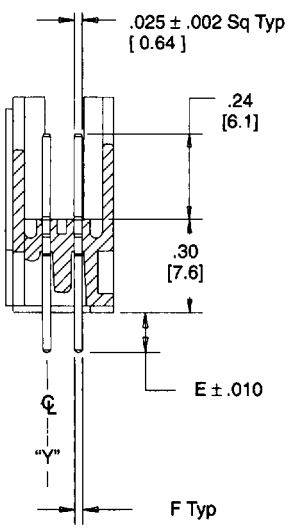

Section A-A
(Straight)

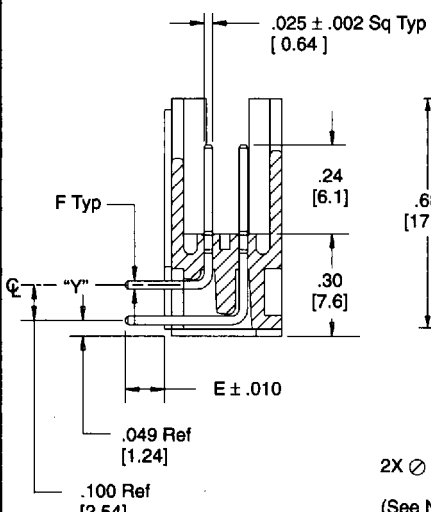
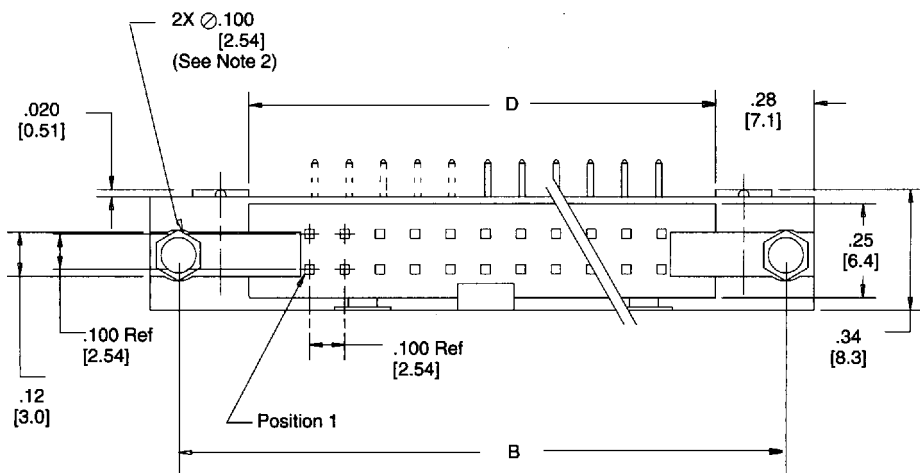

Section B-B
(Right Angle)

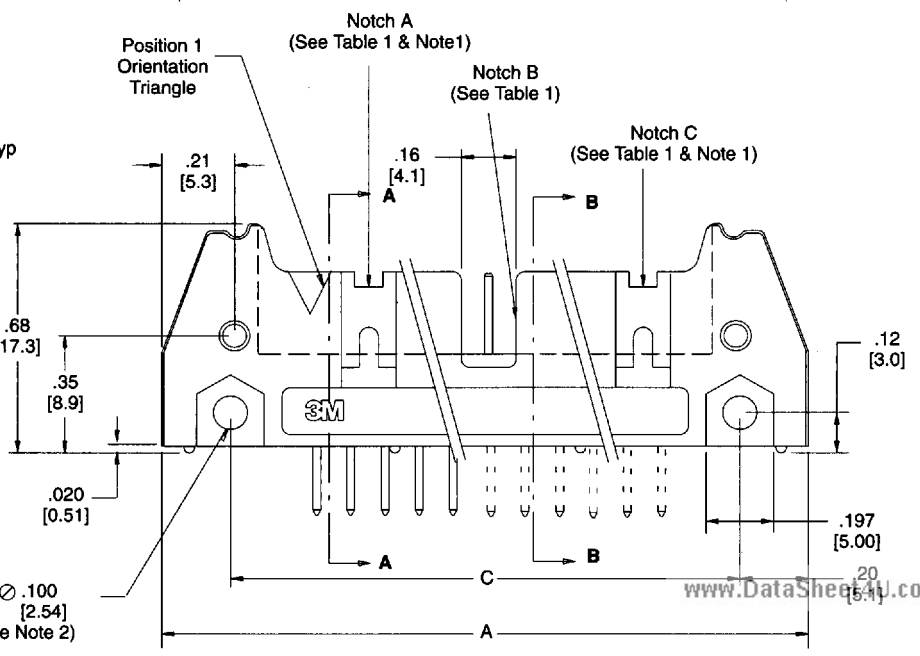

.100" × .100" Latch/Ejector Header

4 Wall, Straight & Right Angle, High Temp Option

Pin Quantity	3M Part Number	Dimensions				Polarization Notches Provided
		A	B	C	D	
10	3793	1.26 [32.1]	1.105 [28.07]	.865 [21.97]	.71 [18.0]	B C
14	3314	1.46 [37.2]	1.305 [33.15]	1.065 [27.05]	.91 [23.1]	B C
16	3408	1.56 [39.7]	1.405 [35.69]	1.165 [29.59]	1.01 [25.6]	A B C
20	3428	1.76 [44.8]	1.605 [40.77]	1.365 [34.67]	1.21 [30.7]	A B C
24	3627	1.96 [49.8]	1.805 [45.85]	1.565 [39.75]	1.41 [35.8]	A B C
26	3429	2.06 [52.4]	1.905 [48.39]	1.665 [42.29]	1.51 [38.3]	A B C
30	3440	2.26 [57.4]	2.105 [53.47]	1.865 [47.37]	1.71 [43.43]	A B C
34	3431	2.46 [62.6]	2.305 [58.55]	2.065 [52.45]	1.91 [48.5]	A B C
40	3432	2.76 [70.2]	2.605 [66.17]	2.365 [60.07]	2.21 [56.1]	A B C
50	3433	3.26 [82.9]	3.105 [78.87]	2.865 [72.77]	2.71 [68.8]	A B C
60	3372	3.76 [95.6]	3.605 [91.57]	3.365 [85.47]	3.21 [81.5]	A B C
64	3764	3.96 [100.7]	3.805 [96.65]	3.565 [90.55]	3.41 [86.6]	A B C

3M Part Number Suffix	Contact Tail	Dimension E	Pin Cross Section			Dimension G
			Dimension F	Diagonals	Corner Radii	
-5XX2 -6XX2	Solder Tail for .062 [1.57] Thick PC Board	.112 [2.84]	0.0245 ± .0005 [0.622]	0.028 ± .001 [0.71]	0.0075 Ref [0.191]	.035 ± .003 [0.89] (See Note 3)
-5X03 -6X03	Solder Tail for .094 [2.39] to .125 [3.18] Thick PC Board	.155 [3.94]	0.0245 ± .0005 [0.622]	0.028 ± .001 [0.71]	0.0075 Ref [0.191]	.035 ± .003 [0.89]
-5X05 -6X05	Wire Wrap Tail for up to 3 Levels of Wire Wrap	.61 Ref [15.5]	0.0250 ± .002 [0.635]	0.035 ± .003 [0.90]	0.003 Max [0.08]	.045 ± .003 [1.14]

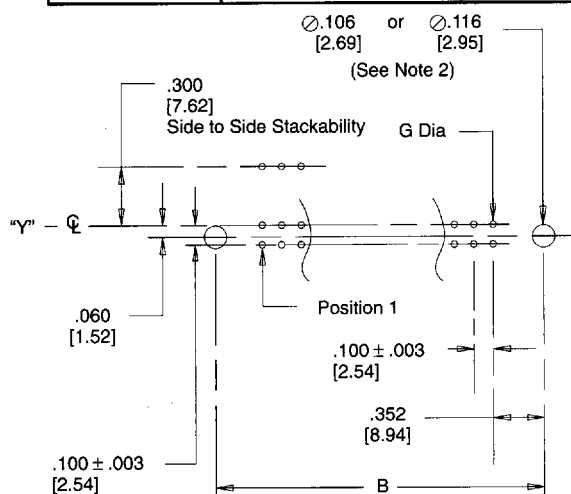

Recommended Mounting Hole Pattern (Straight)

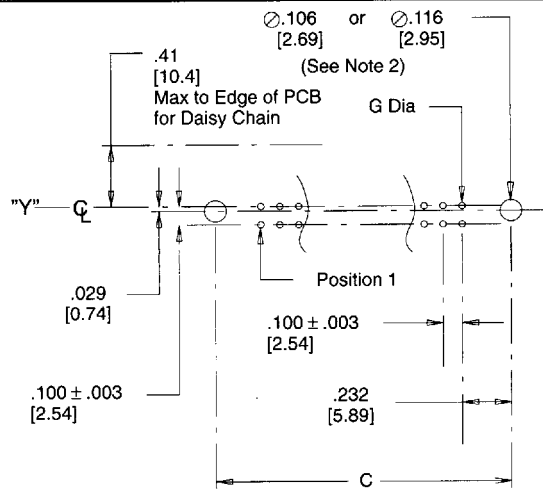

Recommended Mounting Hole Pattern (Right Angle)

Inch [mm]

Notes:

- Notches A & C will accommodate 3M Polarizing Keys (3M Part #N3518).
- Accepts Rear and Front mounting hardware:
Rear Entry: #4-24 thread cutting screw, 3M Part #3341-5, .116 [2.95] dia mounting hole
Front Entry: (Prior to installation of latch on Straight Versions) #2-56 bolt and nut, 3M Part #3341-6, .106 [2.69] dia mounting hole
- The recommended PCB hole size for the kinked tail positions on the .112 solder tail connector is .035 ± .002.

Tolerance Unless Noted		
Inch	± .1	± .01 ± .005

[] Dimensions for Reference only

.100" × .100" Latch/Ejector Header

4 Wall, Straight & Right Angle, High Temp Option

Ordering Information

30 Microinches Gold Plated Product

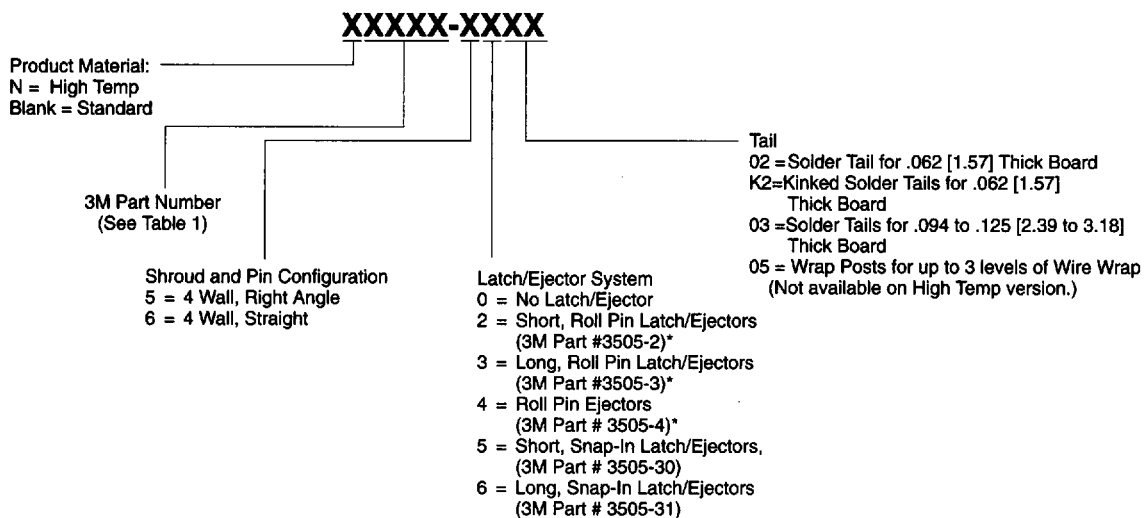

15 Microinches Gold Plated Product

