

# 3515 AND 3516

## RATIOMETRIC, LINEAR HALL-EFFECT SENSORS FOR HIGH-TEMPERATURE OPERATION

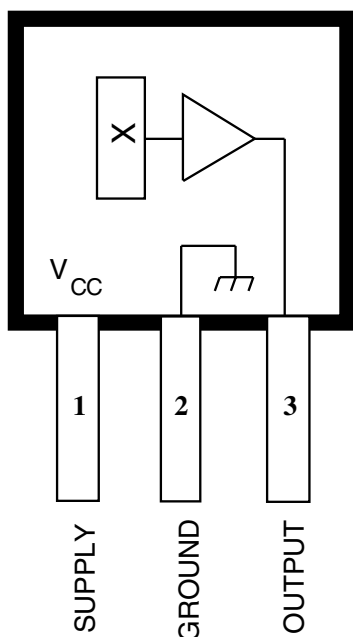

Dwg. PH-006

Pinning is shown viewed from branded side.

### ABSOLUTE MAXIMUM RATINGS

Supply Voltage, $V_{CC}$ .....	<b>8.0 V</b>
Output Voltage, $V_O$ .....	<b>8.0 V</b>
Output Sink Current, $I_O$ .....	<b>10 mA</b>
Magnetic Flux Density, $B$ .....	<b>Unlimited</b>
Package Power Dissipation, $P_D$ .....	<b>See Graph</b>
Operating Temperature Range*, $T_A$	
Suffix 'E-' .....	<b>-40°C to +85°C</b>
Suffix 'L-' .....	<b>-40°C to +150°C</b>
Storage Temperature Range, $T_S$ .....	<b>-65°C to +170°C</b>

\* Infrequent excursions permitted; see Applications Information.

The A3515- and A3516- are sensitive, temperature-stable linear Hall-effect sensors with greatly improved offset characteristics. Ratiometric, linear Hall-effect sensors provide a voltage output that is proportional to the applied magnetic field and have a quiescent output voltage that is approximately 50% of the supply voltage. These magnetic sensors are ideal for use in linear and rotary position sensing systems in the harsh environments of automotive and industrial applications over extended temperatures to -40°C and +150°C. The A3515- features an output sensitivity of 5 mV/G, while the A3516- has an output sensitivity of 2.5 mV/G. See the Magnetic Characteristics table for complete, individual device parametrics.

Each BiCMOS monolithic circuit integrates a Hall element, improved temperature-compensating circuitry to reduce the intrinsic sensitivity drift of the Hall element, a small-signal high-gain amplifier, and a rail-to-rail low-impedance output stage.

A proprietary dynamic offset cancelation technique, with an internal high-frequency clock, reduces the residual offset voltage, which is normally caused by device overmolding, temperature dependancies, and thermal stress. This technique produces devices that have an extremely stable quiescent output voltage, are immune to mechanical stress, and have precise recoverability after temperature cycling. Many problems normally associated with low-level analog signals are minimized by having the Hall element and amplifier in a single chip. Output precision is obtained by internal gain and offset trim adjustments during the manufacturing process.

These devices are supplied in a 3-pin ultra-mini-SIP 'UA' package.

### FEATURES

- Temperature-Stable Quiescent Output Voltage
- Precise Recoverability After Temperature Cycling
- Output Voltage Proportional to Applied Magnetic Field
- Ratiometric Rail-to-Rail Output
- Improved Sensitivity
- 4.5 V to 5.5 V Operation
- Immune to Mechanical Stress
- Small Package Size
- Solid-State Reliability

Always order by complete part number, e.g., **A3515LUA** .

# 3515 AND 3516 RATIOMETRIC, LINEAR HALL-EFFECT SENSORS

## FUNCTIONAL BLOCK DIAGRAM

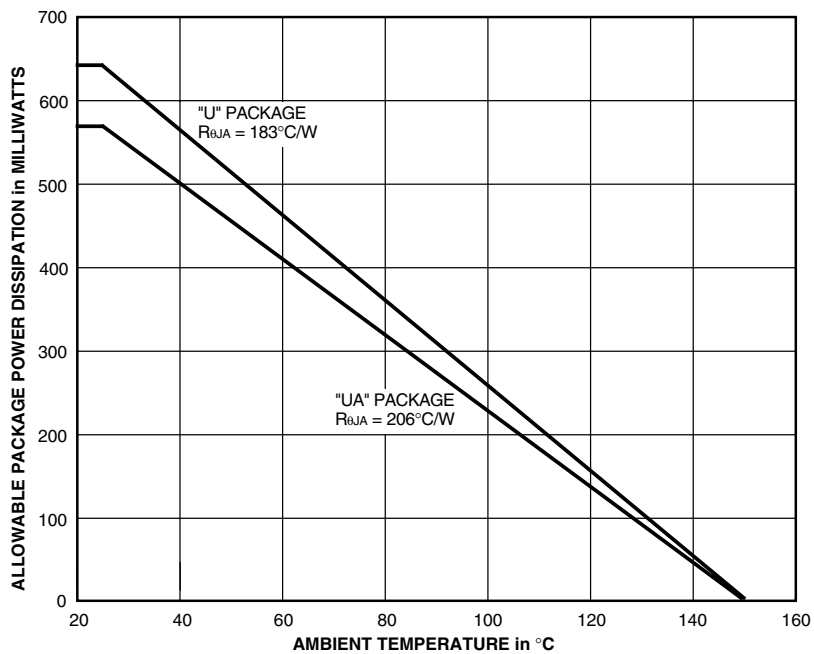
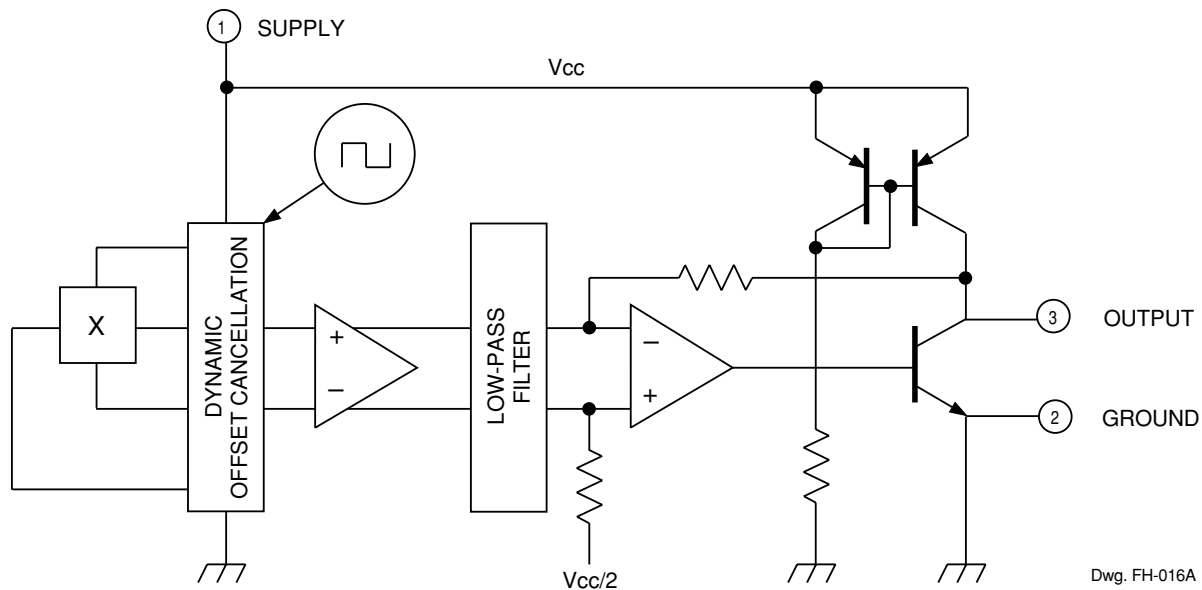

**3515 AND 3516  
RATIOMETRIC,  
LINEAR  
HALL-EFFECT SENSORS**

**ELECTRICAL CHARACTERISTICS** over operating temperature range, at  $V_{CC} = 5\text{ V}$  (unless otherwise noted).

Characteristic	Symbol	Test Conditions	Limits			
			Min.	Typ.	Max.	Units
Supply Voltage	$V_{CC}$	Operating	4.5	5.0	5.5	V
Supply Current	$I_{CC}$	$B = 0, V_{CC} = 6\text{ V}, I_O = 0$	–	7.2	10	mA
Quiescent Voltage Output	$V_{OQ}$	$B = 0, I_O = 1\text{ mA}, T_A = 25^\circ\text{C}$	2.425	2.500	2.575	V
Output Voltage	$V_{OH}$	$B = +X^*, I_O = 1\text{ mA}$	–	4.7	–	V
	$V_{OL}$	$B = -X^*, I_O = -1\text{ mA}$	–	0.2	–	V
Output Source Current Limit	$I_{OLM}$	$B = -X^*, V_O = 0$	-1.0	-1.5	–	mA
Bandwidth (-3 dB)	BW		–	30	–	kHz
Clock Frequency	$f_C$		–	170	–	kHz
Output Resistance	$r_O$	$I_O \leq -2\text{ mA}$	–	1.0	–	$\Omega$
Wide-Band Output Noise (rms)	$e_o$	$B = 0, BW = 10\text{ Hz to }10\text{ kHz}, I_O \leq -1\text{ mA}, C_O = 100\text{ pF}$	–	400	–	$\mu\text{V}$

NOTE 1 – Typical data is at  $T_A = 25^\circ\text{C}$  and is for design information only.

NOTE 2 – Negative current is defined as coming out of (sourcing) the output.

\* This test requires positive and negative fields sufficient to swing the output driver between fully OFF and saturated (ON), respectively. It is NOT intended to indicate a range of linear operation.

# 3515 AND 3516 RATIOMETRIC, LINEAR HALL-EFFECT SENSORS

**MAGNETIC CHARACTERISTICS** over operating temperature range, at  $V_{CC} = 5\text{ V}$ ,  $I_O = -1\text{ mA}$  (unless otherwise noted).

Characteristic*	Part Numbers												Units
	A3515EUA			A3515LUA			A3516EUA			A3516LUA			
	Min.	Typ.	Max.	Min.	Typ.	Max.	Min.	Typ.	Max.	Min.	Typ.	Max.	
Operating Temp. Range, $T_A$	-40	-	+85	-40	-	+150	-40	-	+85	-40	-	+150	°C
Sensitivity at $T_A = 25^\circ\text{C}$	4.50	5.00	5.50	4.50	5.00	5.50	2.25	2.50	2.75	2.25	2.50	2.75	mV/G
$\Delta\text{Sens}_{(\Delta T)}$ at $T_A = \text{Max.}$	-2.5	2.5	7.5	-2.5	2.5	7.5	-2.5	2.5	7.5	-2.5	2.5	7.5	%
$\Delta\text{Sens}_{(\Delta T)}$ at $T_A = \text{Min.}$	-9.0	-1.3	1.0	-9.0	-1.3	1.0	-9.0	-1.3	1.0	-9.0	-1.3	1.0	%
$\Delta V_{OQ(\Delta T)}^\dagger$	-	-	$\pm 10$	-	-	$\pm 10$	-	-	$\pm 10$	-	-	$\pm 10$	G
Ratiometry, $\Delta V_{OQ(\Delta V)}$	-	100	-	-	100	-	-	100	-	-	100	-	%
Ratiometry, $\Delta\text{Sens}_{(\Delta V)}$	-	100	-	-	100	-	-	100	-	-	100	-	%
Positive Linearity, Lin+	-	100	-	-	100	-	-	100	-	-	100	-	%
Negative Linearity, Lin-	-	100	-	-	100	-	-	100	-	-	100	-	%
Symmetry	-	100	-	-	100	-	-	100	-	-	100	-	%

NOTE 1 – Magnetic flux density is measured at most sensitive area of device located 0.018" (0.46 mm) below the branded face of the “UA” package.

NOTE 2 – 10 G = 1 mT, exactly.

NOTE 3 – Except for  $\Delta\text{Sens}_{(\Delta T)}$ , typical data is at  $T_A = 25^\circ\text{C}$  and is for design information only.

\* See Characteristics Definitions for test conditions.

† This calculation (formula 1, next page) yields the device’s equivalent accuracy, over the operating temperature range, in gauss.

## CHARACTERISTICS DEFINITIONS

**Quiescent Voltage Output.** In the quiescent state (no magnetic field), the output is ideally equal to one-half of the supply voltage over the operating voltage and temperature range ( $V_{OQ} \cup V_{CC}/2$ ). Due to internal component tolerances and thermal considerations, there is a tolerance on the quiescent voltage output and on the quiescent voltage output as a function of supply voltage and ambient temperature. For purposes of specification, the quiescent voltage output as a function of temperature is defined as

$$\Delta V_{OQ(\Delta T)} = \frac{V_{OQ(TA)} - V_{OQ(25^{\circ}C)}}{Sens_{(25^{\circ}C)}} \quad (1)$$

This calculation yields the device's equivalent accuracy, over the operating temperature range, in gauss.

**Sensitivity.** The presence of a south-pole magnetic field perpendicular to the package face (the branded surface) will increase the output voltage from its quiescent value toward the supply voltage rail by an amount proportional to the magnetic field applied. Conversely, the application of a north pole will decrease the output voltage from its quiescent value. This proportionality is specified as the sensitivity of the device and is defined as

$$Sens = \frac{V_{O(500G)} - V_{O(-500G)}}{1000 \text{ G}} \quad (2)$$

The stability of sensitivity as a function of temperature is defined as

$$\Delta Sens_{(\Delta T)} = \frac{Sens_{(TA)} - Sens_{(25^{\circ}C)}}{Sens_{(25^{\circ}C)}} \times 100\% \quad (3)$$

**Ratiometry.** The A3515xUA and A3516xUA feature a ratiometric output. The quiescent voltage output and sensitivity are proportional to the supply voltage (ratiometric).

The per cent ratiometric change in the quiescent voltage output is defined as

$$\Delta V_{OQ(\Delta V)} = \frac{V_{OQ(VCC)} / V_{OQ(5V)}}{V_{CC} / 5 \text{ V}} \times 100\% \quad (4)$$

and the per cent ratiometric change in sensitivity is defined as

$$\Delta Sens_{(\Delta V)} = \frac{Sens_{(VCC)} / Sens_{(5V)}}{V_{CC} / 5 \text{ V}} \times 100\% \quad (5)$$

**Linearity and Symmetry.** The on-chip output stage is designed to provide a linear output to within 500 mV of either rail with a supply voltage of 5 V. This is equivalent to approximately  $\pm 800$  gauss of ambient field. Although application of stronger magnetic fields will not damage these devices, it will force the output into a non-linear region. Linearity in per cent is measured and defined as

$$Lin+ = \frac{V_{O(500G)} - V_{OQ}}{2 (V_{O(250G)} - V_{OQ})} \times 100\% \quad (6)$$

$$Lin- = \frac{V_{O(-500G)} - V_{OQ}}{2 (V_{O(-250G)} - V_{OQ})} \times 100\% \quad (7)$$

and output symmetry as

$$Sym = \frac{V_{O(500G)} - V_{OQ}}{V_{OQ} - V_{O(-500G)}} \times 100\% \quad (8)$$

# 3515 AND 3516 RATIOMETRIC, LINEAR HALL-EFFECT SENSORS

## TYPICAL CHARACTERISTICS

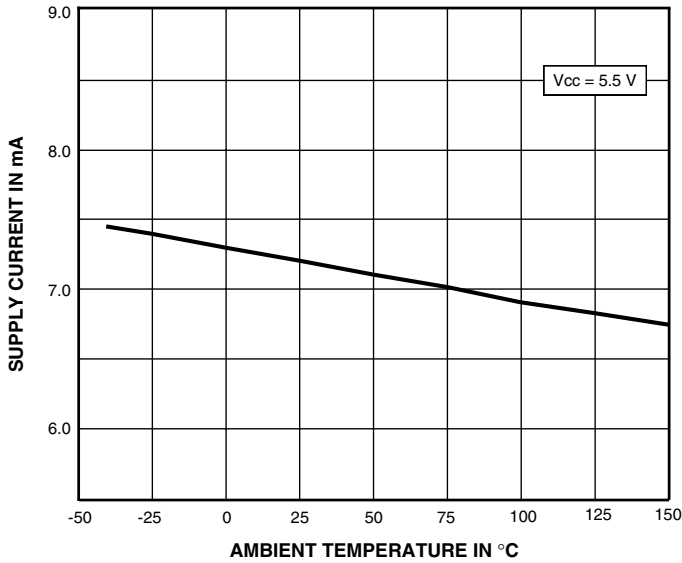

Dwg. GH-039-2

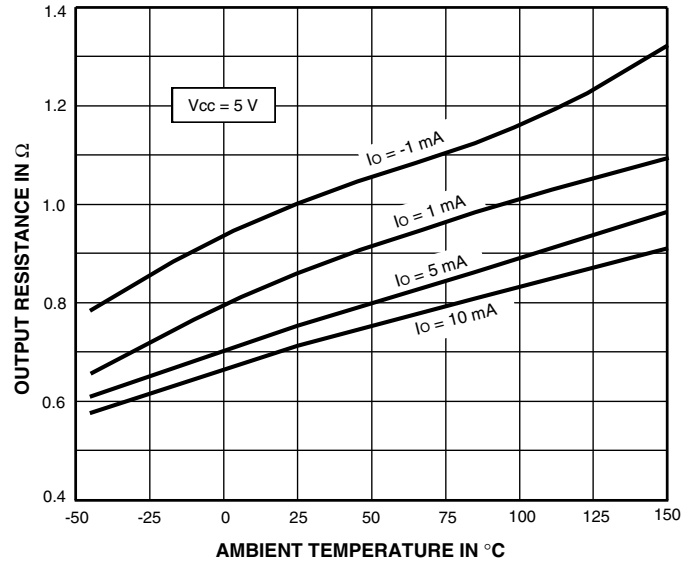

Dwg. GH-060-1

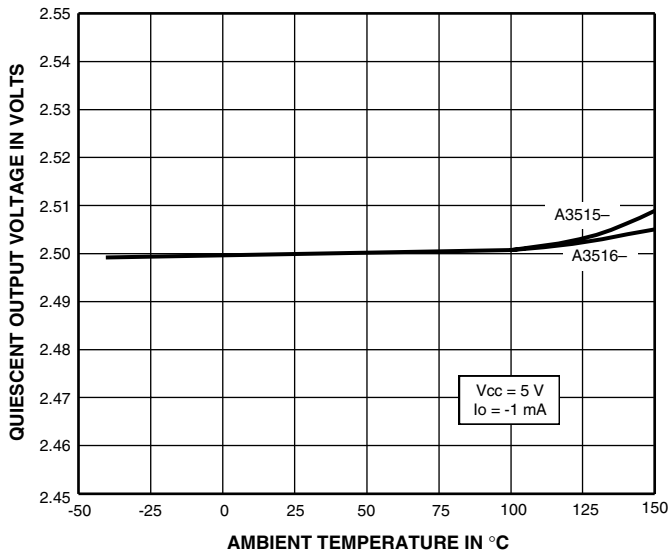

Dwg. GH-067

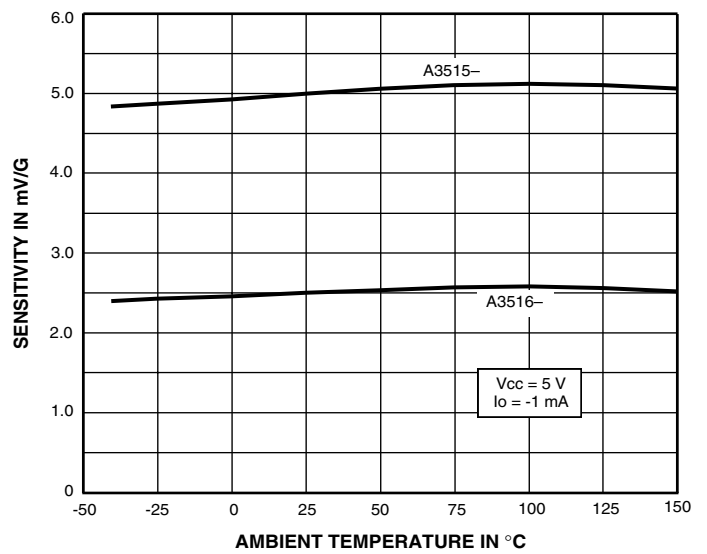

Dwg. GH-066

**3515 AND 3516  
RATIOMETRIC,  
LINEAR  
HALL-EFFECT SENSORS**

**CRITERIA FOR DEVICE QUALIFICATION**

All Allegro sensors are subjected to stringent qualification requirements prior to being released to production. To become qualified, except for the destructive ESD tests, no failures are permitted.

<b>Qualification Test</b>	<b>Test Method and Test Conditions</b>	<b>Test Length</b>	<b>Samples</b>	<b>Comments</b>
Temperature Humidity Bias Life	JESD22-A101 $T_A = 85^{\circ}\text{C}$ , RH = 85%	1000 hrs	77	Device biased for minimum power
Bias Life	JESD22-A108 $T_A = 150^{\circ}\text{C}$ , $T_J = 165^{\circ}\text{C}$	1000 hrs	77	
(Surge Operating Life)	JESD22-A108 $T_A = 175^{\circ}\text{C}$ , $T_J = 190^{\circ}\text{C}$	168 hrs	77	
Autoclave, Unbiased	JESD22-A102 $T_A = 121^{\circ}\text{C}$ , 15 psig	96 hrs	77	
High-Temperature (Bake) Storage Life	JESD22-A103 $T_A = 170^{\circ}\text{C}$	1000 hrs	77	
Temperature Cycle	JESD22-A104	1000 cycles	77	
ESD, Human Body Model	CDF-AEC-Q100-002	Pre/Post Reading	3 per test	Test to failure All leads > 3 kV

# 3515 AND 3516 RATIOMETRIC, LINEAR HALL-EFFECT SENSORS

## APPLICATIONS INFORMATION

Calibrated linear Hall devices, which can be used to determine the actual flux density presented to the sensor in a particular application, are available.

For safe, reliable operation, the output should not be pulled above the supply voltage or pulled below the device ground.

For optimum performance, a 0.1  $\mu\text{F}$  capacitor between the supply and ground, and a 100 pF capacitor between the output and ground, should be added.

The ratiometric feature is especially valuable when these devices are used with an analog-to-digital converter. A/D converters typically derive their LSB step size by ratioing off a reference voltage line. If the reference voltage varies, the LSB will vary proportionally. This is a major error source in many sensing systems. The A3515xUA and A3516xUA can eliminate this source of error by their ratiometric operation. Because their gain and offsets are proportional to the supply voltage, if they are powered from the A/D reference voltage, the sensor output voltage will track changes in the LSB value.

These devices can withstand infrequent temperature excursions, beyond the Absolute Maximum Ratings, to  $T_A = 170^\circ\text{C}$  provided the junction temperature,  $T_J$ , does not exceed  $200^\circ\text{C}$ .

Extensive applications information on Hall-effect sensors and magnets is also available in the "Hall-Effect IC Applications Guide", which can be found in the latest issue of the *Allegro MicroSystems Electronic Data Book*, AMS-702 or *Application Note 27701*, or at

[www.allegromicro.com](http://www.allegromicro.com)

## TYPICAL CURRENT-SENSING APPLICATION

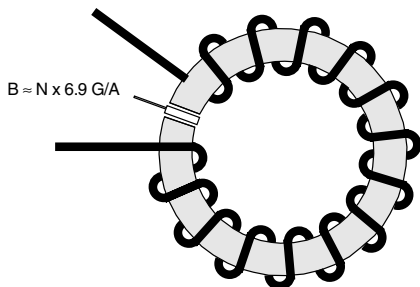

Dwg. AH-005A

## SENSOR LOCATION

### SUFFIX "UA"

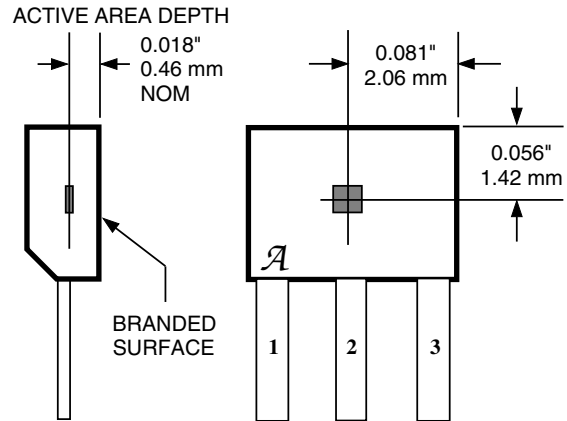

Dwg. MH-011-7



# 3515 AND 3516 RATIOMETRIC, LINEAR HALL-EFFECT SENSORS

## TYPICAL POSITION-SENSING APPLICATIONS (Alnico 8, dimensions in inches)

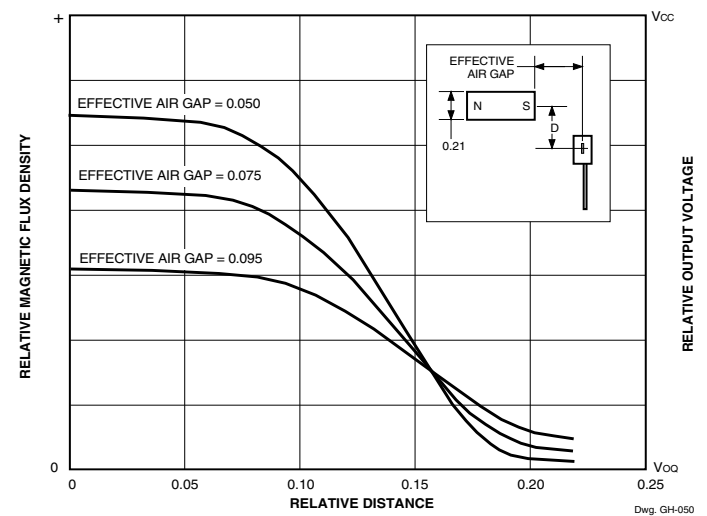
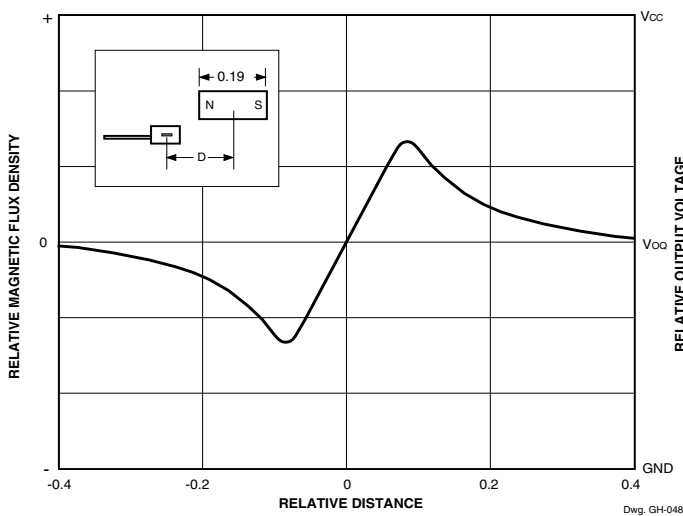
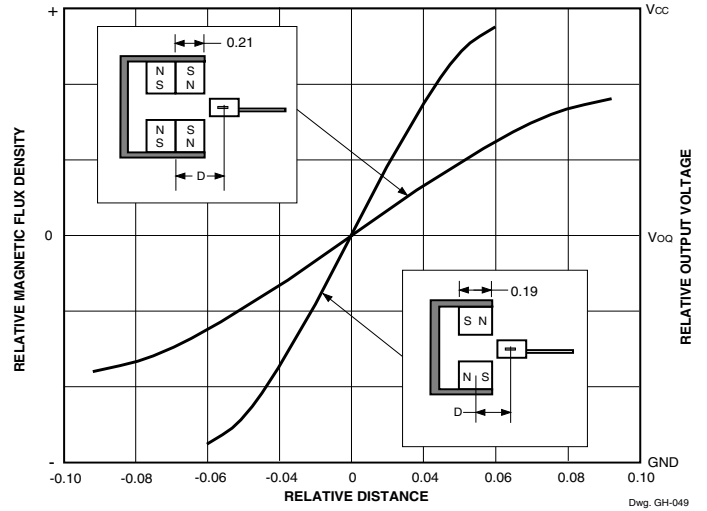
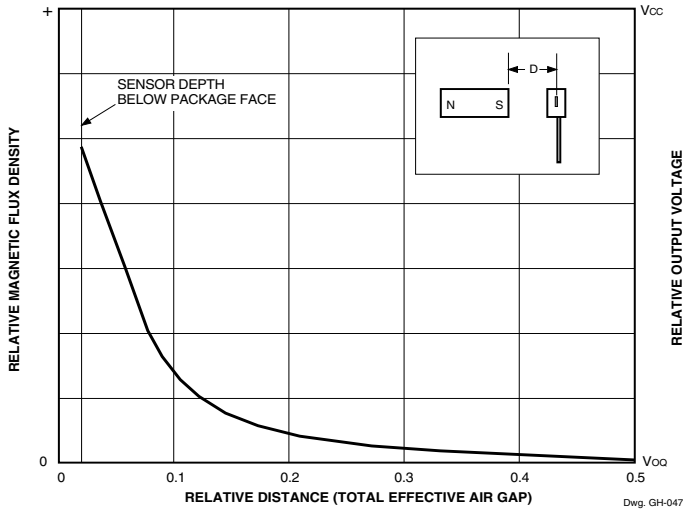

**3515 AND 3516  
RATIOMETRIC,  
LINEAR  
HALL-EFFECT SENSORS**

**A3515xUA and A3516xUA**

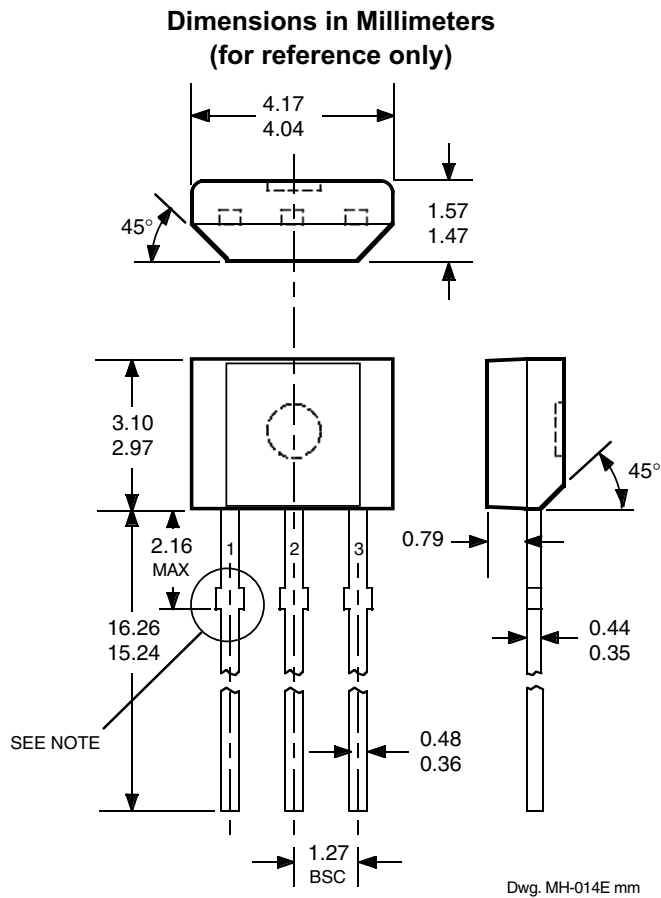
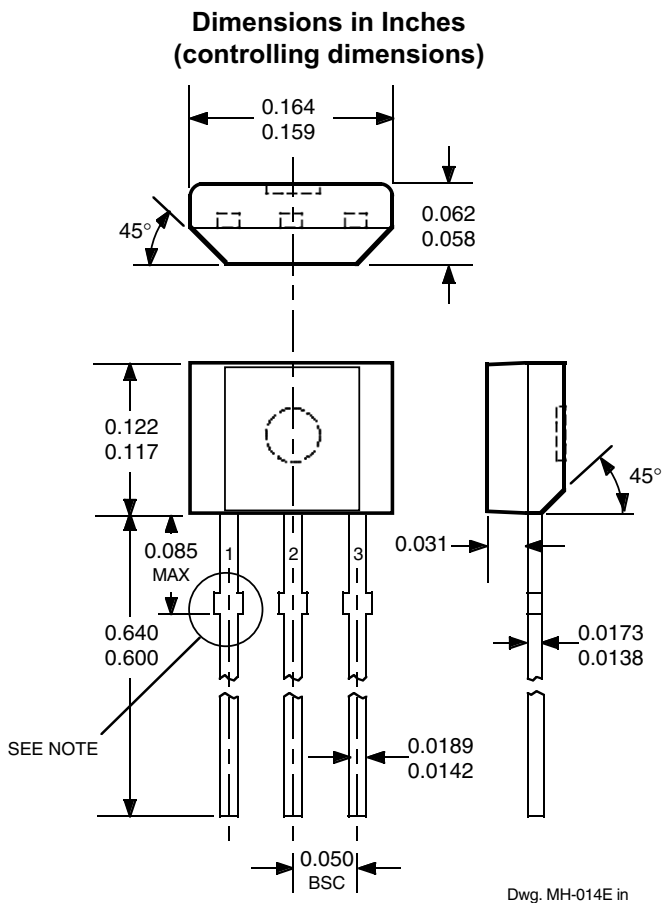

- NOTES:
1. Tolerances on package height and width represent allowable mold offsets. Dimensions given are measured at the widest point (parting line).
  2. Exact body and lead configuration at vendor's option within limits shown.
  3. Height does not include mold gate flash.
  4. Recommended minimum PWB hole diameter to clear transition area is 0.035" (0.89 mm).
  5. Where no tolerance is specified, dimension is nominal.
  6. Supplied in bulk pack (500 devices per bag).

# 3515 AND 3516 RATIOMETRIC, LINEAR HALL-EFFECT SENSORS

## Surface-Mount Lead Form (add '-TL' to part number)

**Dimensions in Inches  
(controlling dimensions)**

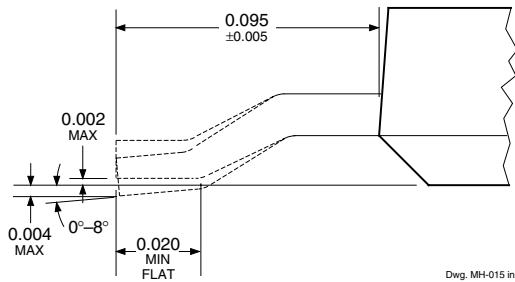

**Dimensions in Millimeters  
(for reference only)**

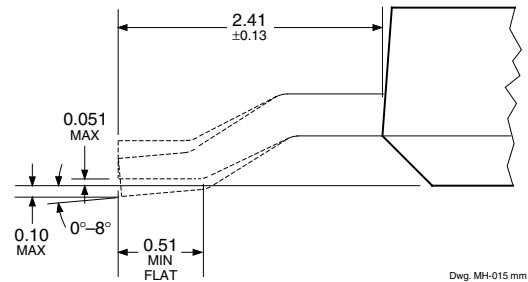

NOTE: Supplied in bulk pack (500 devices per bag).

*The products described herein are manufactured under one or more of the following U.S. patents: 5,045,920; 5,264,783; 5,442,283; 5,389,889; 5,581,179; 5,517,112; 5,619,137; 5,621,319; 5,650,719; 5,686,894; 5,694,038; 5,729,130; 5,917,320; and other patents pending.*

*Allegro MicroSystems, Inc. reserves the right to make, from time to time, such departures from the detail specifications as may be required to permit improvements in the performance, reliability, or manufacturability of its products. Before placing an order, the user is cautioned to verify that the information being relied upon is current.*

*Allegro products are not authorized for use as critical components in life-support appliances, devices, or systems without express written approval.*

*The information included herein is believed to be accurate and reliable. However, Allegro MicroSystems, Inc. assumes no responsibility for its use; nor for any infringements of patents or other rights of third parties that may result from its use.*

**3515 AND 3516  
RATIOMETRIC,  
LINEAR  
HALL-EFFECT SENSORS**

**HALL-EFFECT SENSORS**

Partial Part Number	Avail. Oper. Temp.	Characteristics at T <sub>A</sub> = +25°C			Features	Notes
		B <sub>OP</sub> max	B <sub>RP</sub> min	B <sub>hys</sub> typ		
<b>RATIOMETRIC, LINEAR HALL-EFFECT SENSORS</b>						
3503	S			typ. 1.3 mV/G		
3507	E/L			typ. 2.5 mV/G		
3508	S			typ. 2.5 mV/G		
3515	E/L			typ. 5.0 mV/G	chopper stabilized	
3516	E/L			typ. 2.5 mV/G	chopper stabilized	
3517	L/S			typ. 5.0 mV/G	chopper stabilized	
3518	L/S			typ. 2.5 mV/G	chopper stabilized	
<b>GEARTOOTH/RING MAGNET (DUAL ELEMENT) HALL-EFFECT SENSORS in order of B<sub>OP</sub></b>						
3060	K/S	+35	-35	30	ac coupled	
3422	E/L	+75	-75	46	direction detection	
3059	K/S	+100	-100	130	ac coupled	
3056	E/L	+150	-150	50	zero-speed	
3058	E/L	+250	-250	200	zero-speed	
3421	E/L	+280	-280	335	direction detection	
<b>SPECIAL-PURPOSE HALL-EFFECT SENSORS</b>						
3054	K/S	+300	+5.0	50	unipolar switch, multiplexed	4
3209	E	±60	±5.0	7.7	400 μW, chopper stabilized	
3210	E	±60	±5.0	7.7	25 μW, chopper stabilized	
3421	E/L	+280	-280	335	direction detection	
3422	E/L	+85	-85	46	direction detection	
3425	L	+24	-24	19	dual, chopper stabilized	1

Operating Temperature Ranges:

S = -20°C to +85°C, E = -40°C to +85°C, J = -40°C to +115°C, K = -40°C to +125°C, L = -40°C to +150°C

Notes 1. Protected.

4. Multiplexed two-wire sensor; after proper address, power/signal bus current indicates magnetic field condition.