

1142.5086

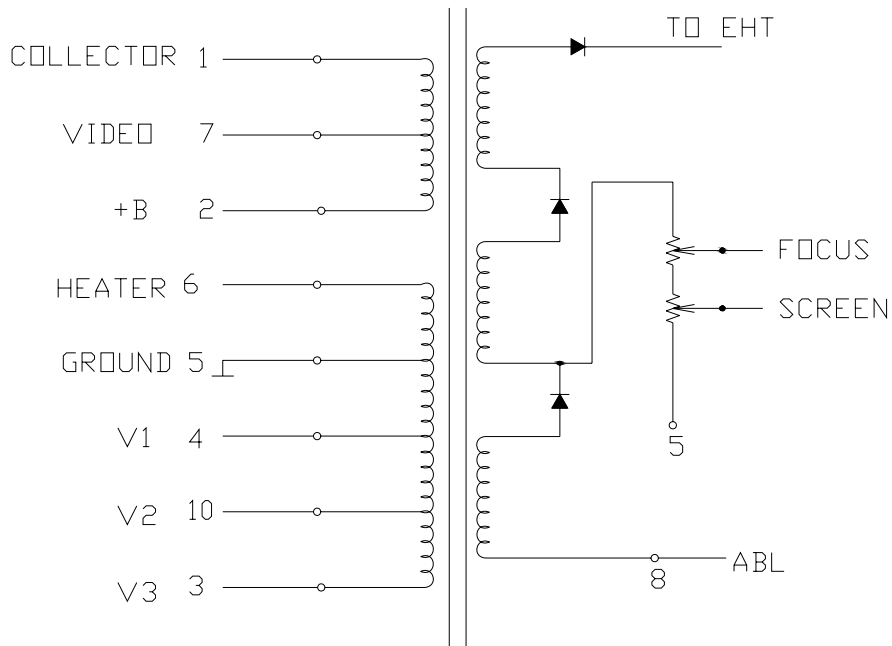

| | |
|----|-----------|
| HV | 25.1KV |
| FV | 3.5-6.1KV |
| SV | 0-890V |

1142.5093

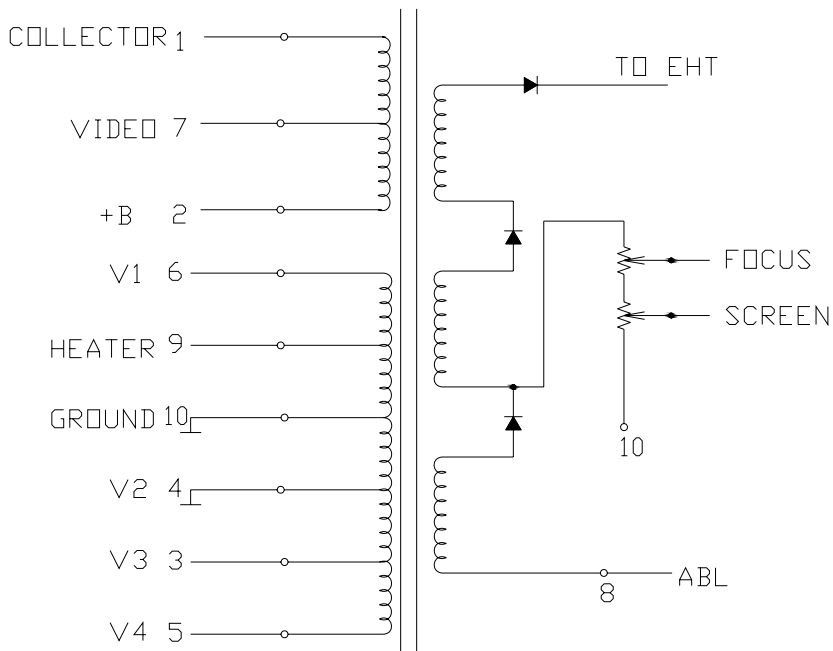

| | |
|----|-----------|
| HV | 27.6KV |
| FV | 5-9.5KV |
| SV | 100-1100V |

1352.5008

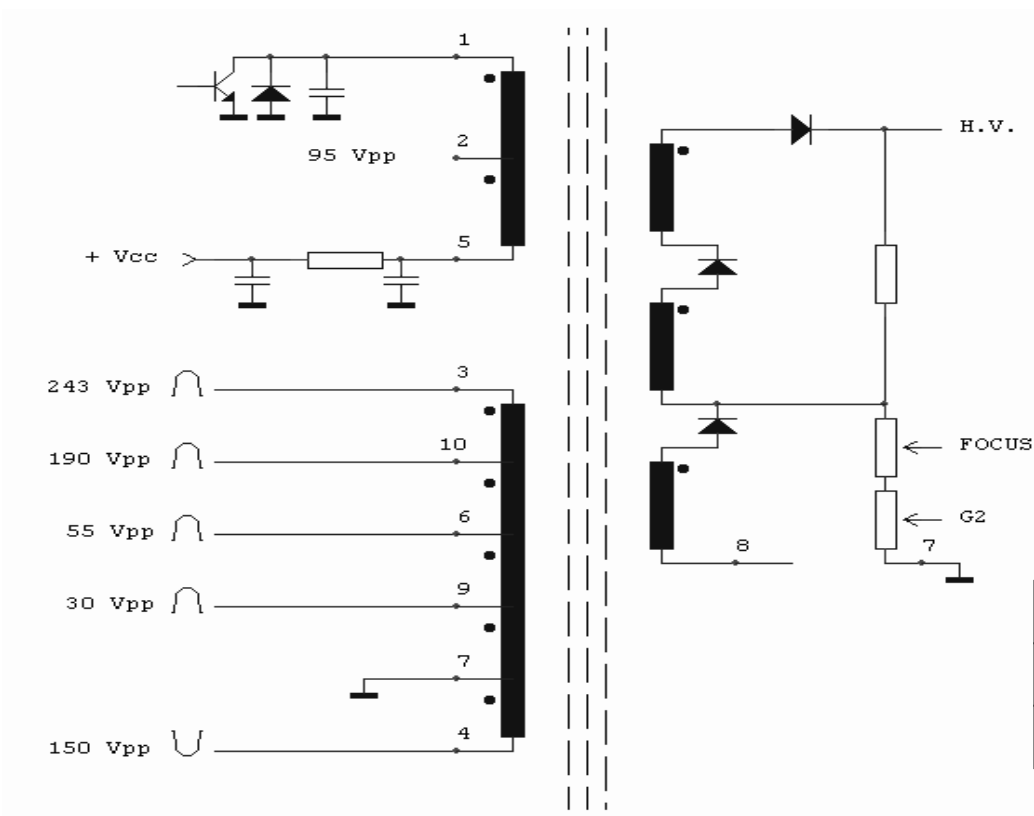

| | |
|----|---------|
| HV | 26KV |
| FV | 4-8.2KV |
| SV | 0-900V |

1352.5033

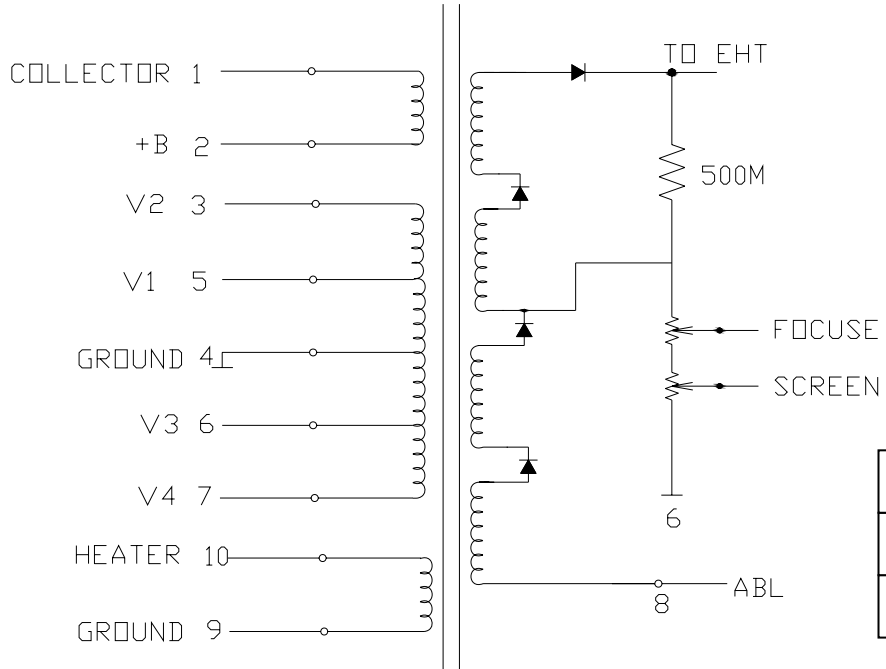

| | |
|----|----------|
| HV | 26 KV |
| FV | 4-8.3 KV |
| SV | 0-920V |

DCF2077A

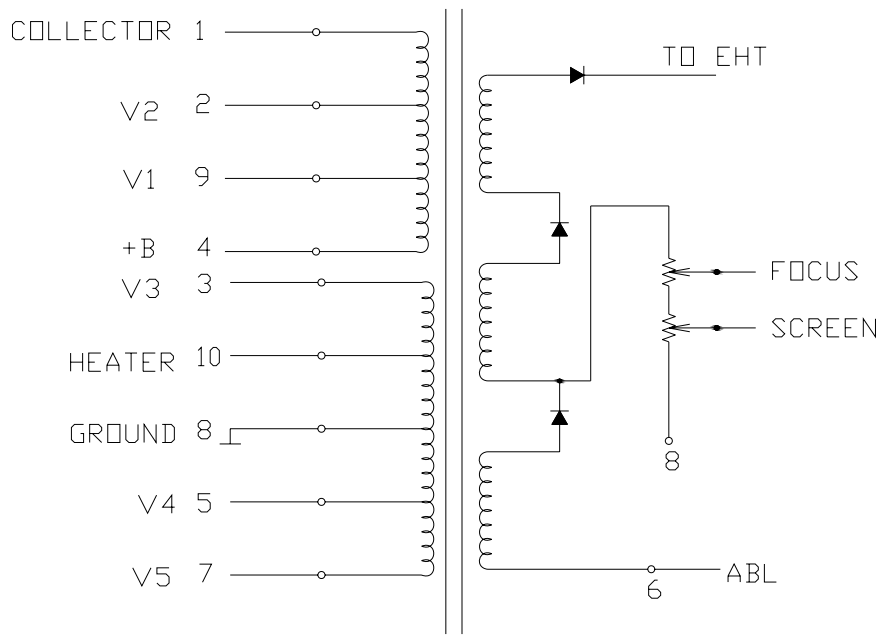

| | |
|----|--------|
| HV | 25KV |
| FV | 4-8KV |
| SV | 0-800V |

36962

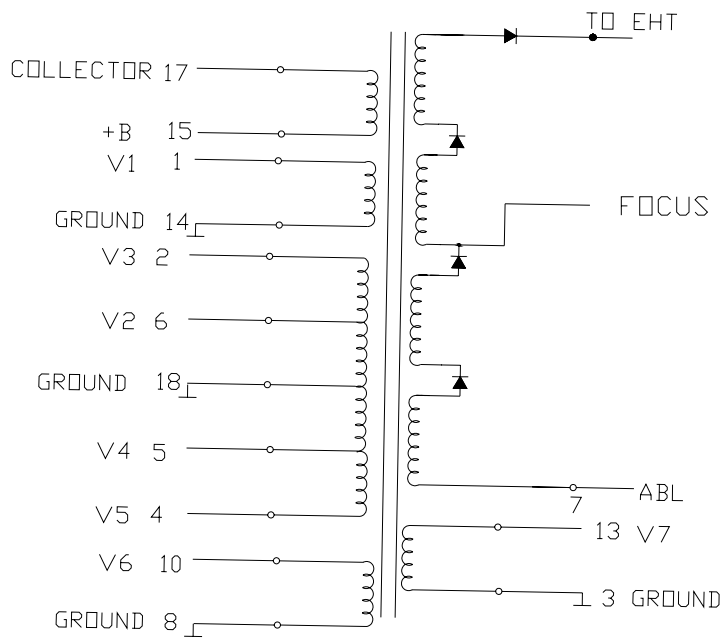

| | |
|----|-------|
| HV | 28KV |
| FV | 9.6KV |
| | |

37622

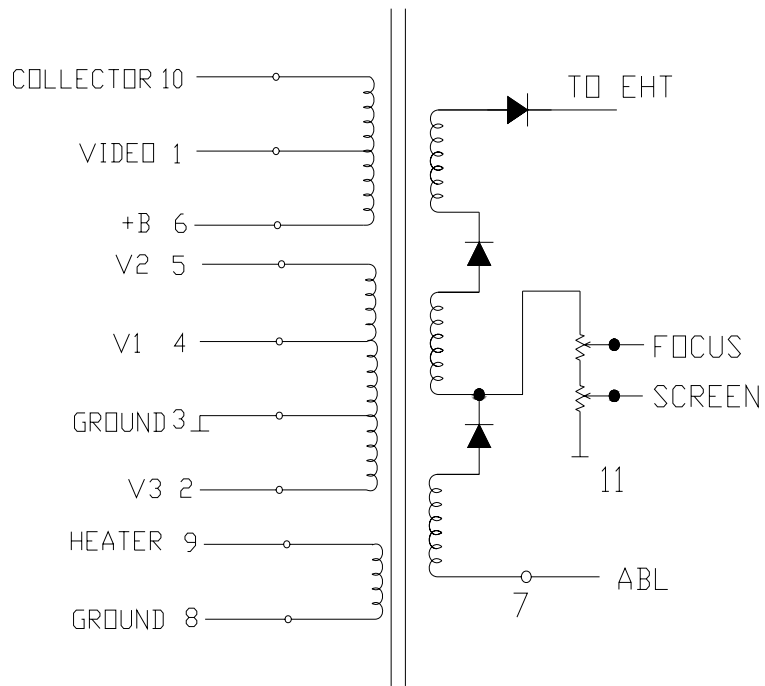

| | |
|----|----|
| HV | KV |
| FV | KV |
| SV | V |

AT2077/88E

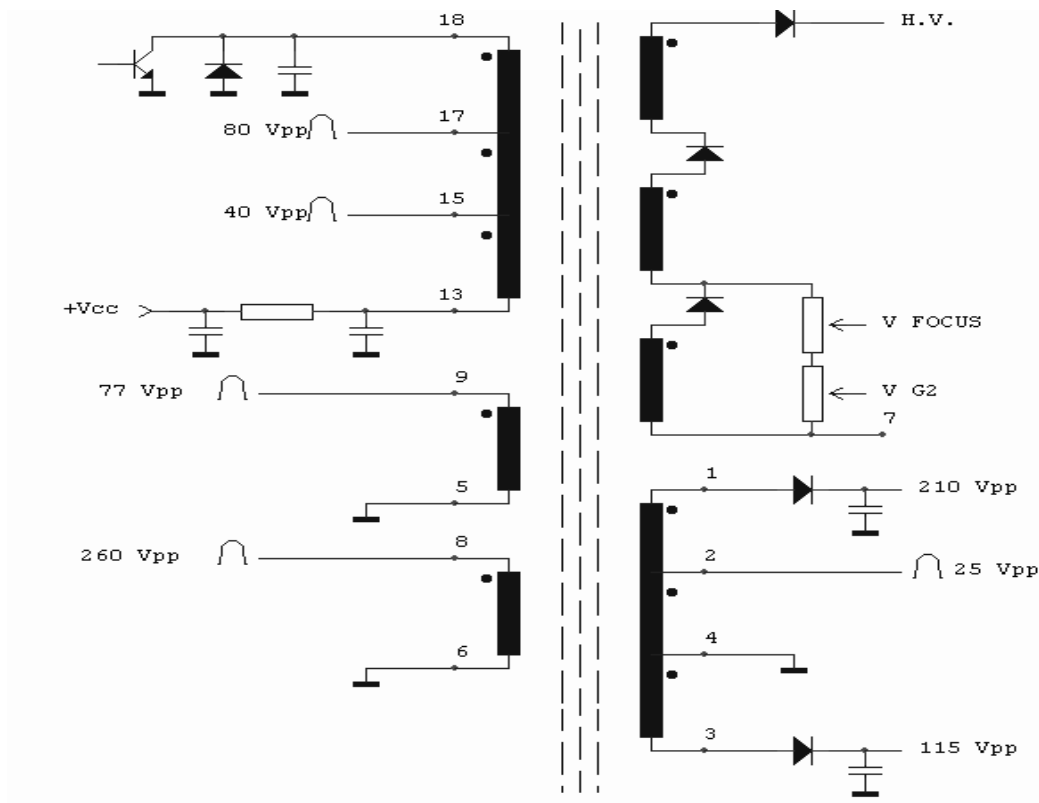

| | |
|----|-----------|
| HV | 21.5KV |
| FV | 3.9-6.8KV |
| SV | 0-1150V |