



# 6AV6—3AV6—12AV6 DUPLEX-DIODE TRIODE

**6AV6  
3AV6  
12AV6**  
ET-T924  
Page 1  
3-55

## DESCRIPTION AND RATING

The 6AV6 is a miniature duplex-diode, high- $\mu$  triode intended primarily for use as a combined detector, amplifier, and automatic-volume-control tube in radio receivers. The triode section incorporates a high amplification factor and is capable of providing a relatively large undistorted output voltage from a very small input signal.

The 3AV6, 6AV6, and 12AV6 are alike except for heater ratings and heater-cathode voltage ratings. The 12AV6 is particularly suited for use in a-c/d-c radio receivers. The 3AV6, as a result of its controlled heater warm-up characteristic, is especially well suited for use in television receivers which employ series-connected heaters. When the 3AV6 is used in conjunction with other 600-milliamper types which exhibit essentially the same heater warm-up characteristic, heater voltage surges across the individual tubes are minimized during the warm-up period.

### GENERAL

#### ELECTRICAL

Cathode—Coated Unipotential	<b>3AV6</b>	<b>6AV6</b>	<b>12AV6</b>
Heater Voltage, AC or DC.....	3.15	6.3	12.6 Volts
Heater Current.....	0.6	0.3	0.15 Amperes
Heater Warm-up Time*.....	11	...	... Seconds
Direct Interelectrode Capacitances	<b>With Shield†</b>	<b>Without Shield</b>	
Triode Grid to Plate.....	2.0	2.0	$\mu\mu\text{f}$
Triode Input.....	2.2	2.2	$\mu\mu\text{f}$
Triode Output.....	1.2	0.8	$\mu\mu\text{f}$
Grid to Diode-Number 2 Plate, maximum.....	0.04	0.04	$\mu\mu\text{f}$

#### Mechanical

Mounting Position—Any  
Envelope—T-5½, Glass  
Base—E7-1, Miniature Button 7-Pin

### MAXIMUM RATINGS

#### DESIGN-CENTER VALUES

Plate Voltage.....	300	Volts
Positive DC Grid Voltage.....	0	Volts
Plate Dissipation.....	0.5	Watts
Heater-Cathode Voltage	<b>3AV6</b>	<b>6AV6</b> <b>12AV6</b>
Heater Positive with Respect to Cathode		
DC Component.....	100	Volts
Total DC and Peak.....	200	90 Volts
Heater Negative with Respect to Cathode		
Total DC and Peak.....	200	90 Volts
Diode Current for Continuous Operation, Each Diode.....	1.0	1.0 Milliamperes

### BASING DIAGRAM

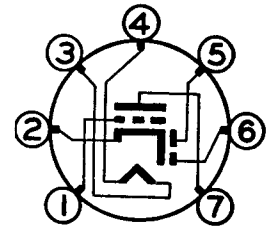

RETMA 7BT

### TERMINAL CONNECTIONS

- Pin 1—Triode Grid
- Pin 2—Cathode
- Pin 3—Heater
- Pin 4—Heater
- Pin 5—Diode Number 2 Plate
- Pin 6—Diode Number 1 Plate
- Pin 7—Triode Plate

### PHYSICAL DIMENSIONS

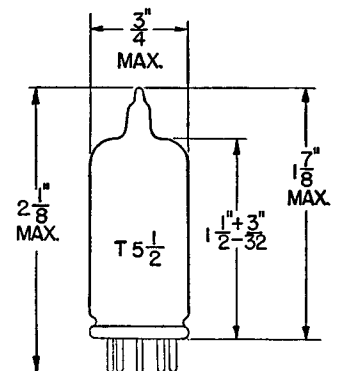

RETMA 5-2

**GENERAL ELECTRIC**

Supersedes ET-T814, dated 6-53

## CHARACTERISTICS AND TYPICAL OPERATION

### CLASS A<sub>1</sub> AMPLIFIER

Plate Voltage .....	100	250	Volts
Grid Voltage .....	-1	-2	Volts
Amplification Factor .....	100	100	
Plate Resistance, approximate .....	80000	62500	Ohms
Transconductance .....	1250	1600	Micromhos
Plate Current .....	0.5	1.2	Milliamperes
Average Diode Current, Each Diode			
With 10 Volts DC Applied .....		2.0	Milliamperes

\* Heater warm-up time is defined as the time required in the circuit shown at the right for the voltage across the heater terminals (V) to increase from zero to the heater test voltage (V<sub>1</sub>). For this type, E=12.5 volts (RMS or DC), V<sub>1</sub>=2.5 volts (RMS or DC), and R=15.8 ohms.

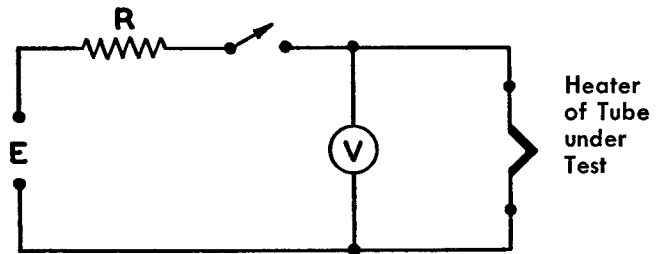

† With external shield (RETMA 316) connected to pin 2.

## CLASS A RESISTANCE-COUPLED AMPLIFIER

R <sub>p</sub> Meg.	R <sub>s</sub> Meg.	R <sub>g1</sub> Meg.	E <sub>bb</sub> = 90 Volts			E <sub>bb</sub> = 180 Volts			E <sub>bb</sub> = 300 Volts		
			R <sub>k</sub>	Gain	E <sub>o</sub>	R <sub>k</sub>	Gain	E <sub>o</sub>	R <sub>k</sub>	Gain	E <sub>o</sub>
0.10	0.10	0.10	1400	31	3.9	900	41	12	780	45	24
0.10	0.24	0.10	1600	37	5.4	1100	47	16	910	52	34
0.24	0.24	0.10	2500	39	5.0	2000	51	14	1500	56	30
0.24	0.51	0.10	3400	43	6.6	2300	55	19	1700	60	38
0.51	0.51	0.10	5800	45	5.6	4000	55	16	2800	61	31
0.51	1.0	0.10	7100	47	7.3	4600	58	20	3500	63	40
0.24	0.24	10	0	34	3.3	0	50	13	0	60	28
0.24	0.51	10	0	41	4.6	0	56	17	0	64	37
0.51	0.51	10	0	39	4.2	0	55	15	0	65	30
0.51	1.0	10	0	42	5.4	0	61	18	0	67	37

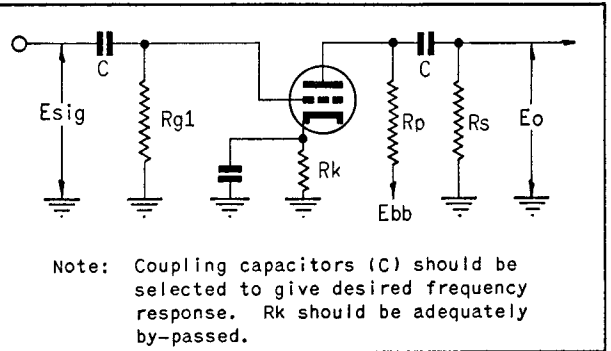

Notes: 1. E<sub>o</sub> is maximum RMS voltage output for five percent (5%) total harmonic distortion. 2. Gain measured at 2.0 volts RMS output. 3. For zero-bias data, generator impedance is negligible.

# AVERAGE PLATE CHARACTERISTICS

TRIODE SECTION

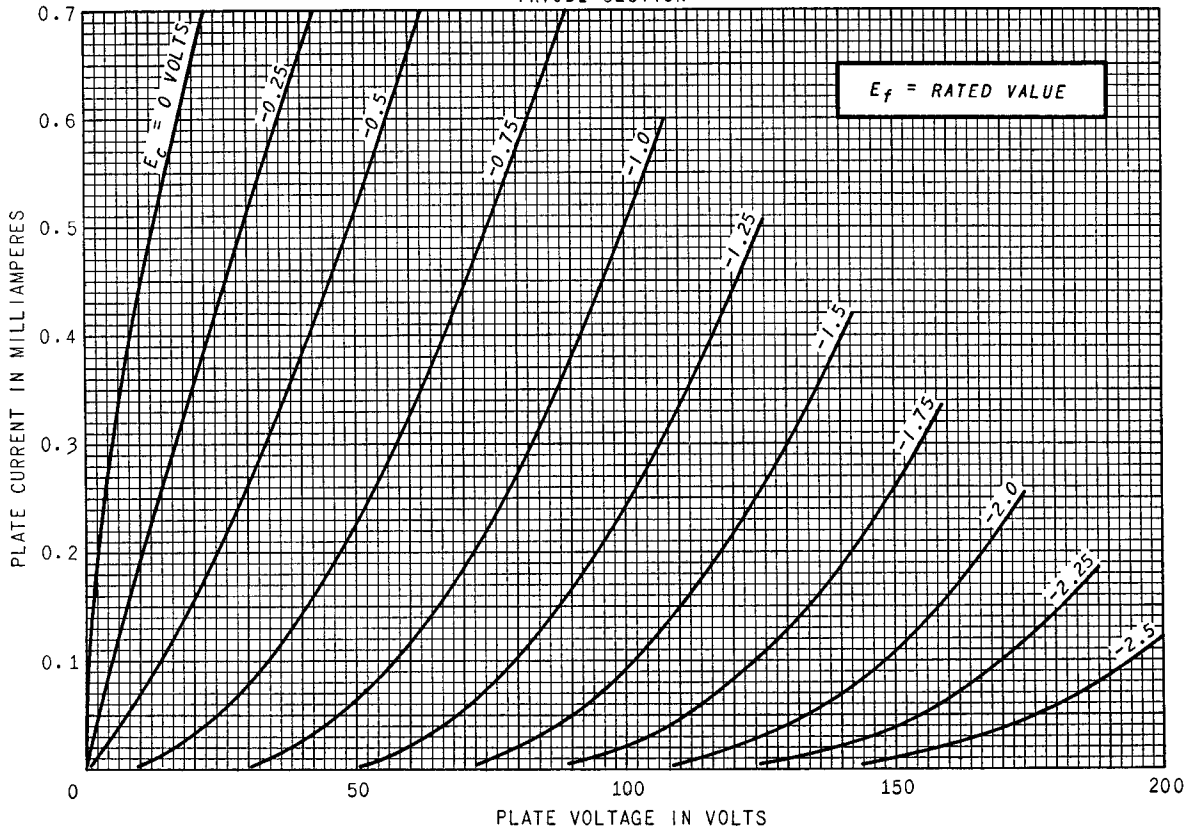

# AVERAGE PLATE CHARACTERISTICS

TRIODE SECTION

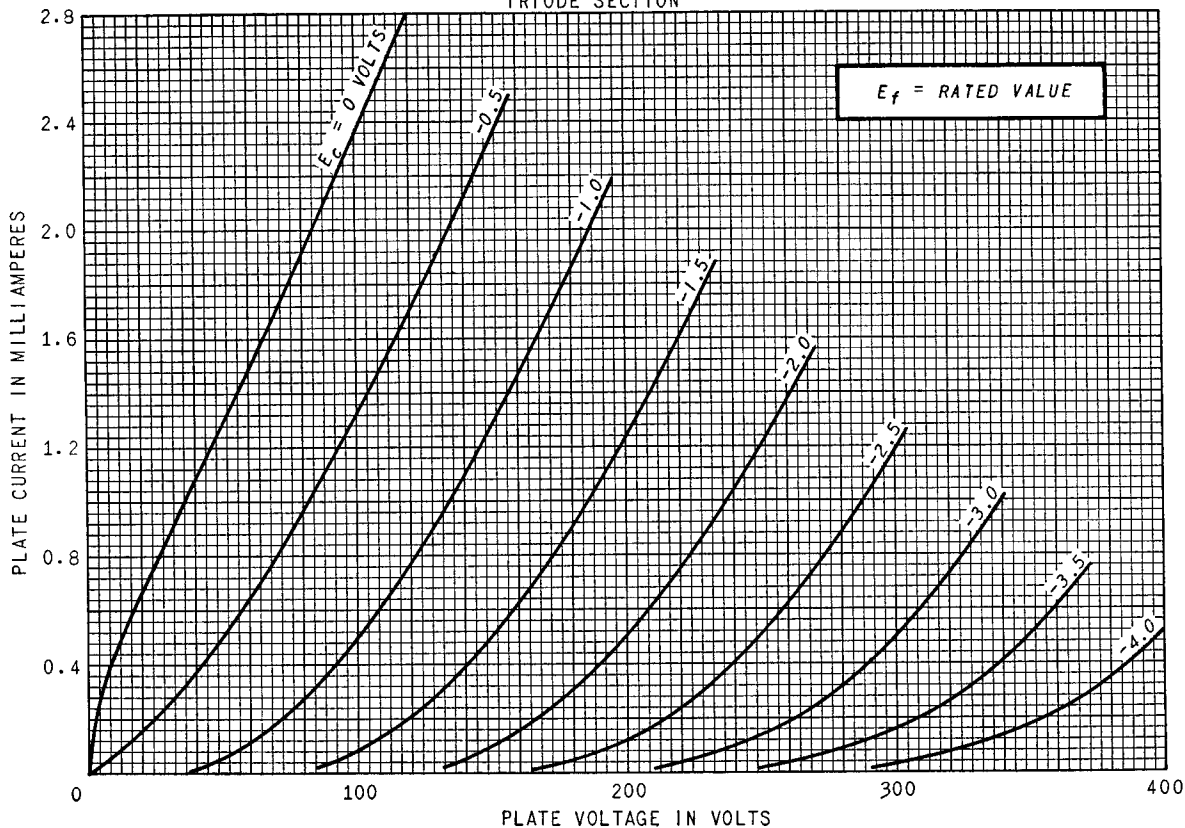

### AVERAGE TRANSFER CHARACTERISTICS

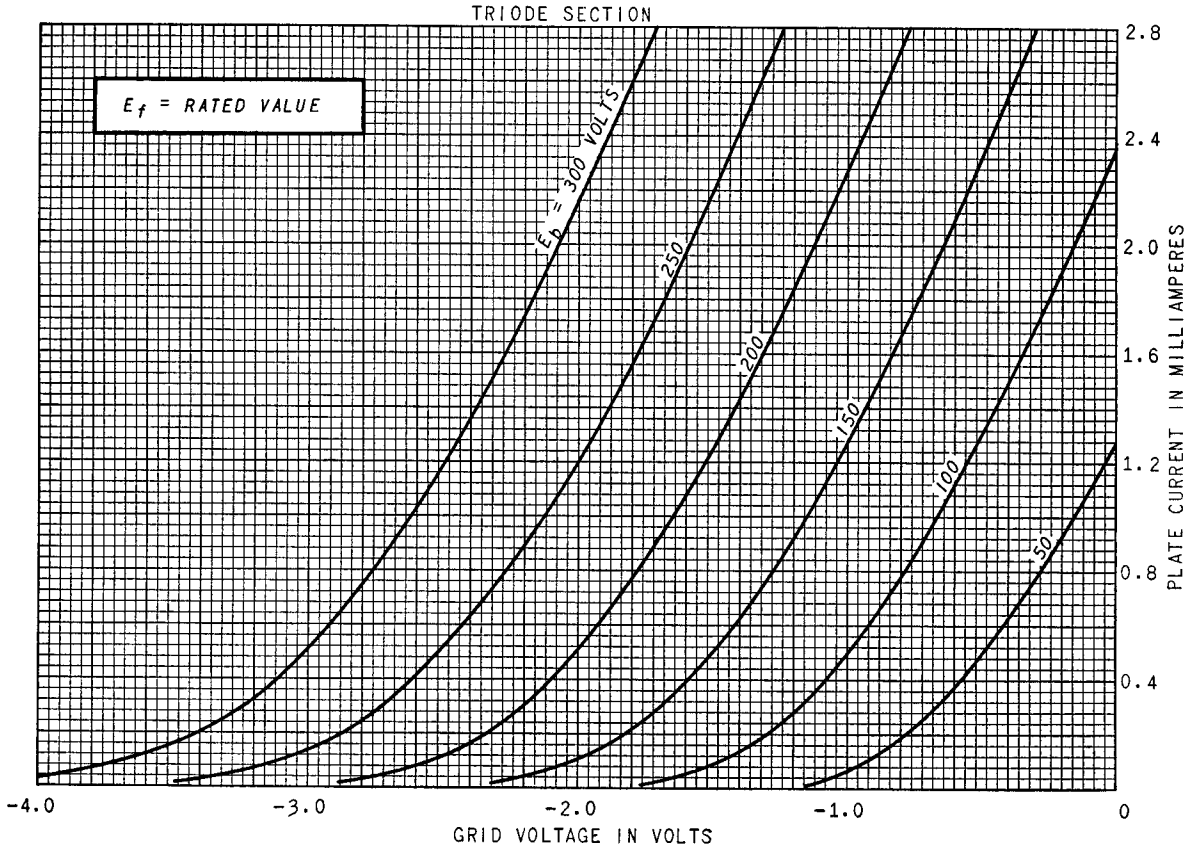

### AVERAGE CHARACTERISTICS

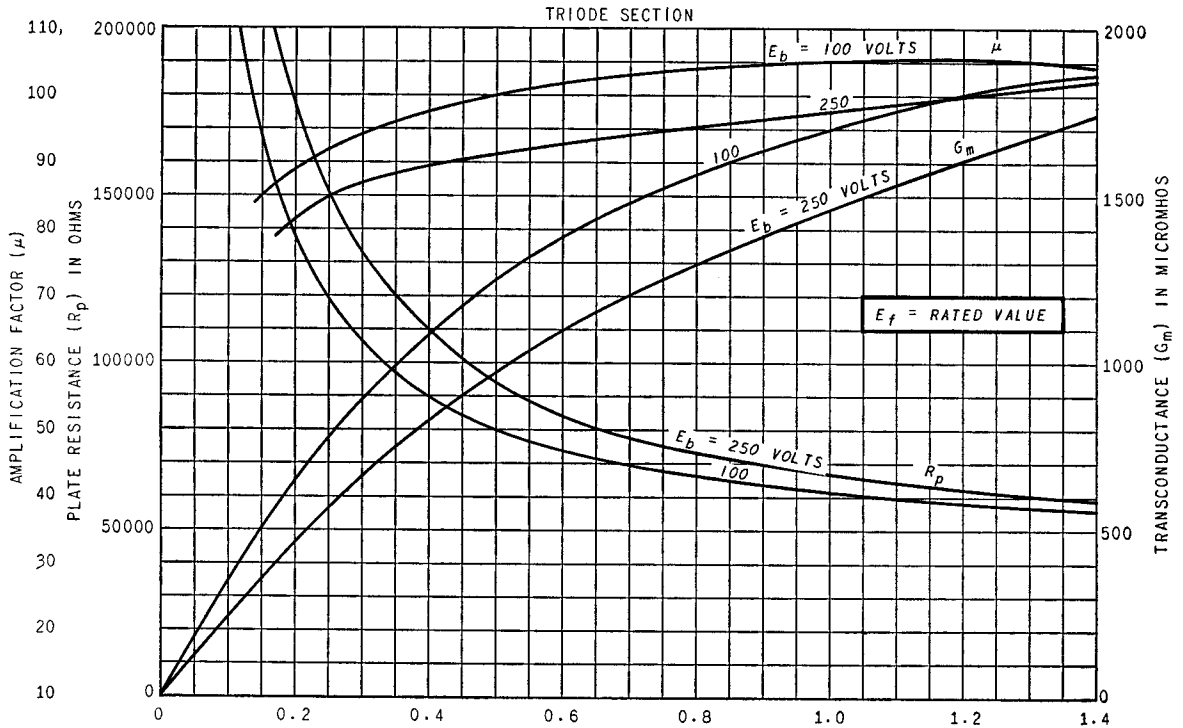

**OPERATION CHARACTERISTICS**  
 EACH DIODE

