

3SK321

Silicon N-Channel Dual Gate MOS FET

HITACHI

ADE-208-711A (Z)
2nd. Edition
Dec. 1998

Application

UHF RF amplifier

Features

- Low noise figure.
NF = 2.0 dB typ. at $f = 900$ MHz
- Capable of low voltage operation
- Provide mini mold packages; MPAK-4R(SOT-143 var.)

Outline

MPAK-4R

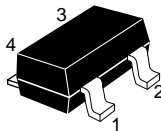

1. Source
2. Drain
3. Gate2
4. Gate1

Absolute Maximum Ratings (Ta = 25°C)

Item	Symbol	Ratings	Unit
Drain to source voltage	V_{DS}	12	V
Gate 1 to source voltage	V_{G1S}	±8	V
Gate 2 to source voltage	V_{G2S}	±8	V
Drain current	I_D	25	mA
Channel power dissipation	Pch	150	mW
Channel temperature	Tch	150	°C
Storage temperature	Tstg	-55 to +150	°C

Attention: This device is very sensitive to electro static discharge.

It is recommended to adopt appropriate cautions when handling this transistor.

Electrical Characteristics (Ta = 25°C)

Item	Symbol	Min	Typ	Max	Unit	Test conditions
Drain to source breakdown voltage	$V_{(BR)DSX}$	12	—	—	V	$I_D = 200 \mu A$, $V_{G1S} = -3 V$, $V_{G2S} = -3 V$
Gate 1 to source breakdown voltage	$V_{(BR)G1SS}$	±8	—	—	V	$I_{G1} = \pm 10 \mu A$, $V_{G2S} = V_{DS} = 0$
Gate 2 to source breakdown voltage	$V_{(BR)G2SS}$	±8	—	—	V	$I_{G2} = \pm 10 \mu A$, $V_{G1S} = V_{DS} = 0$
Gate 1 cutoff current	I_{G1SS}	—	—	±100	nA	$V_{G1S} = \pm 6 V$, $V_{G2S} = V_{DS} = 0$
Gate 2 cutoff current	I_{G2SS}	—	—	±100	nA	$V_{G2S} = \pm 6 V$, $V_{G1S} = V_{DS} = 0$
Drain current	$I_{DS(on)}$	0.5	—	10	mA	$V_{DS} = 6 V$, $V_{G1S} = 0.5 V$, $V_{G2S} = 3 V$
Gate 1 to source cutoff voltage	$V_{G1S(off)}$	-0.5	—	+0.5	V	$V_{DS} = 10 V$, $V_{G2S} = 3 V$, $I_D = 100 \mu A$
Gate 2 to source cutoff voltage	$V_{G2S(off)}$	0	—	+1.0	V	$V_{DS} = 10 V$, $V_{G1S} = 3 V$, $I_D = 100 \mu A$
Forward transfer admittance	$ y_{fs} $	16	20.8	—	mS	$V_{DS} = 6 V$, $V_{G2S} = 3 V$, $I_D = 10 mA$, $f = 1 kHz$
Input capacitance	Ciss	1.2	1.5	2.2	pF	$V_{DS} = 6 V$, $V_{G2S} = 3 V$, $I_D = 10 mA$, $f = 1 MHz$
Output capacitance	Coss	0.6	0.9	1.2	pF	
Reverse transfer capacitance	Crss	—	0.01	0.03	pF	
Power gain	PG	16	19.5	—	dB	$V_{DS} = 4 V$, $V_{G2S} = 3 V$, $I_D = 10 mA$, $f = 900 MHz$
Noise figure	NF	—	2.0	3	dB	

Note: Marking is "ZX—"

Main Characteristics

900MHz Power Gain, Noise Test Circuit

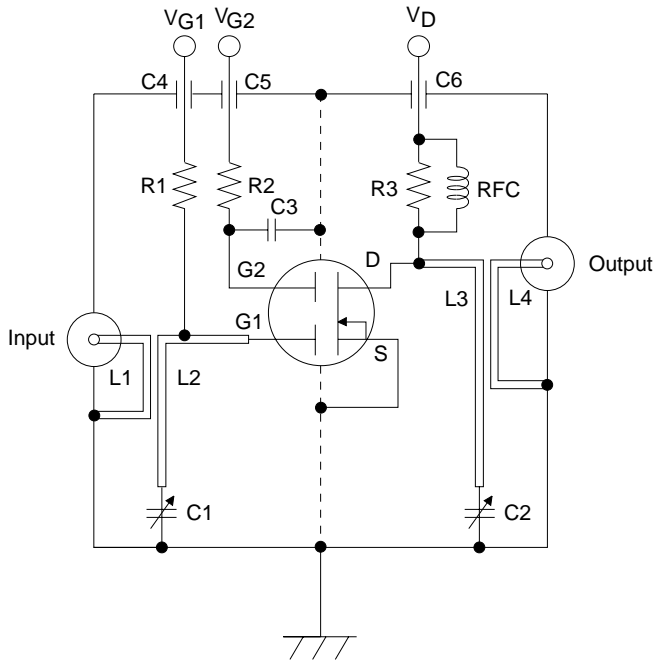

- C1, C2 : Variable Capacitor (10pF MAX)
- C3 : Disk Capacitor (1000pF)
- C4 ~ C6 : Air Capacitor (1000pF)
- R1 : 47 k
- R2 : 47 k
- R3 : 4.7 k

L1 :

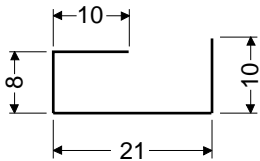

L2 :

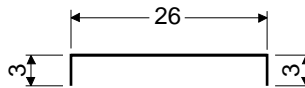

(1mm Copper wire)
Unit : mm

L3 :

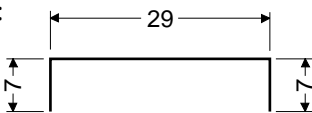

L4 :

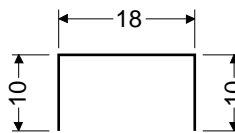

RFC : 1mm Copper wire with enamel 4turns inside dia 6mm

Maximum Channel Power Dissipation Curve

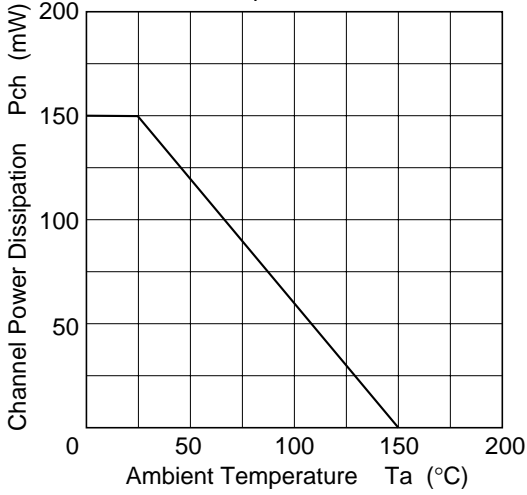

Typical Output Characteristics

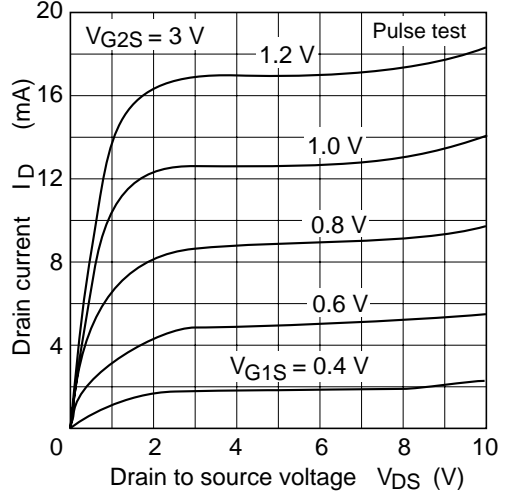

Drain Current vs. Gate1 to Source Voltage

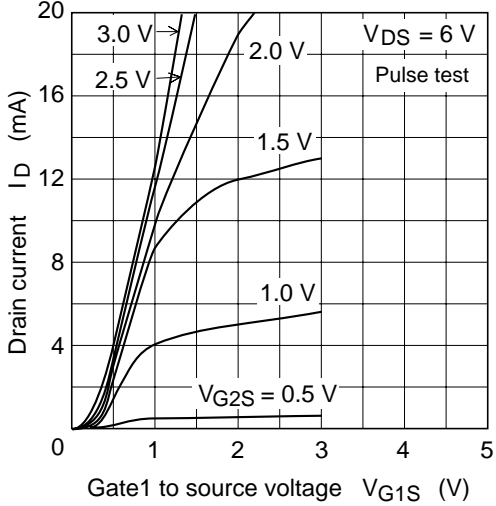

Drain Current vs. Gate2 to Source Voltage

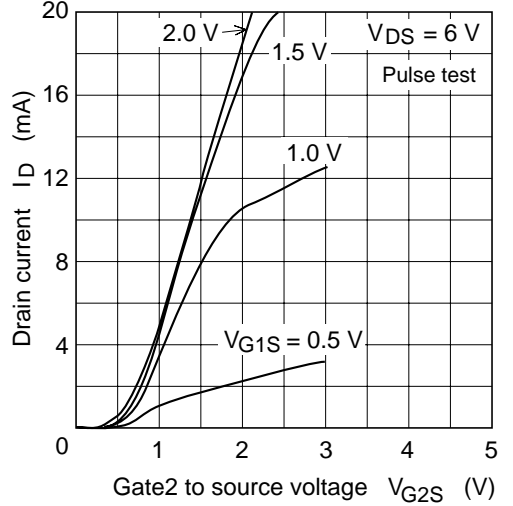

Forward Transfer Admittance vs. Gate1 to Source Voltage

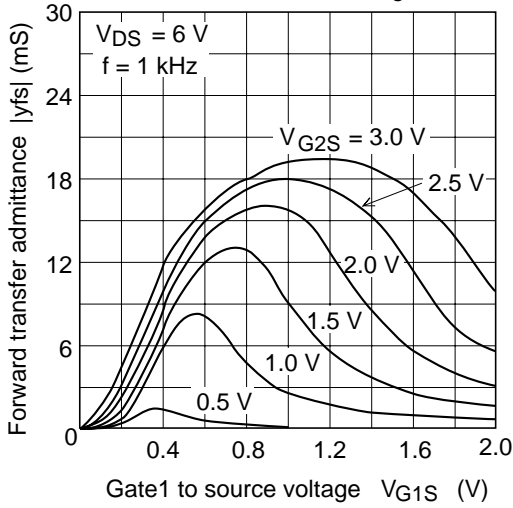

Power Gain vs. Drain Current

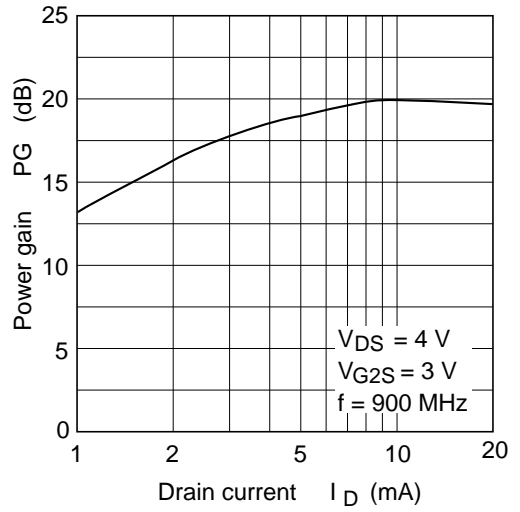

Noise Figure vs. Drain Current

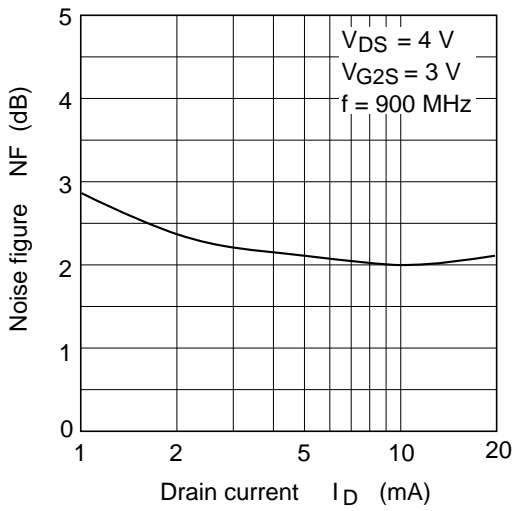

Power Gain vs. Drain to Source Voltage

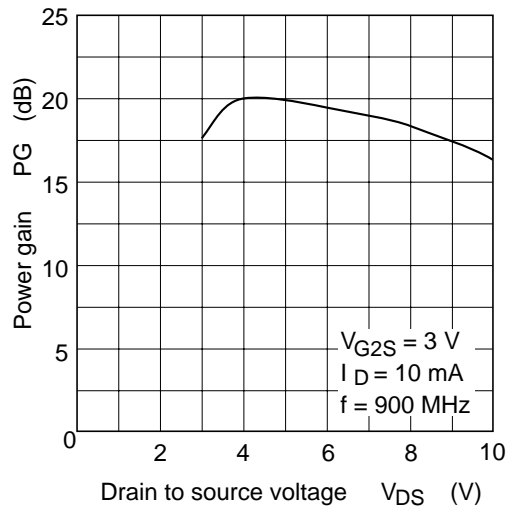

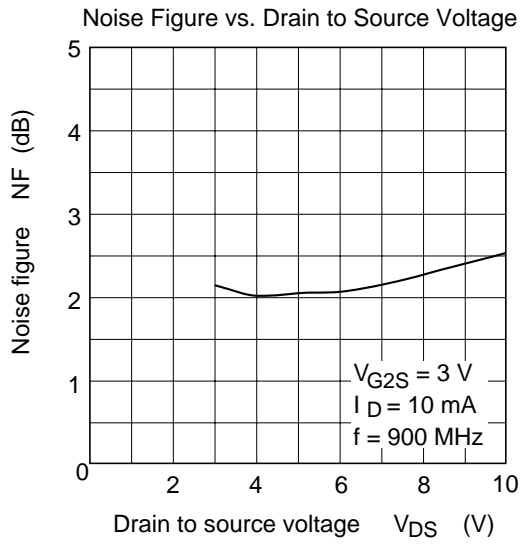

S11 Parameter vs. Frequency

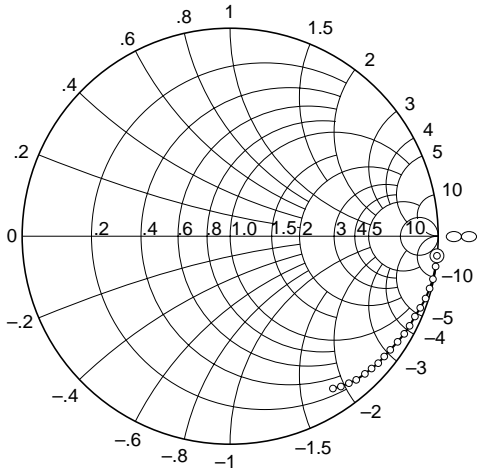

Condition: $V_{DS} = 4\text{ V}$, $V_{G2S} = 3\text{ V}$
 $I_D = 10\text{ mA}$, $Z_o = 50\ \Omega$
 100 to 1000 MHz (50 MHz step)



S21 Parameter vs. Frequency

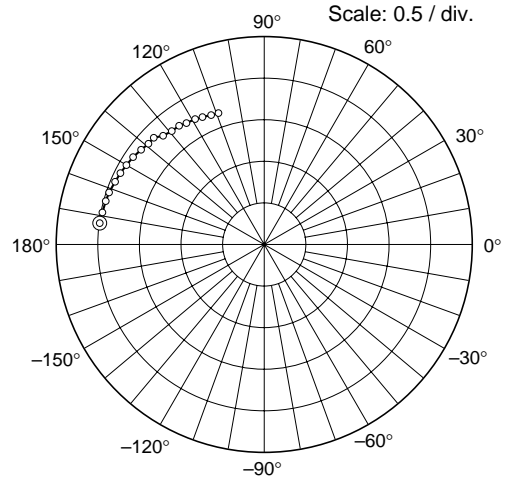

Condition: $V_{DS} = 4\text{ V}$, $V_{G2S} = 3\text{ V}$
 $I_D = 10\text{ mA}$, $Z_o = 50\ \Omega$
 100 to 1000 MHz (50 MHz step)



S12 Parameter vs. Frequency

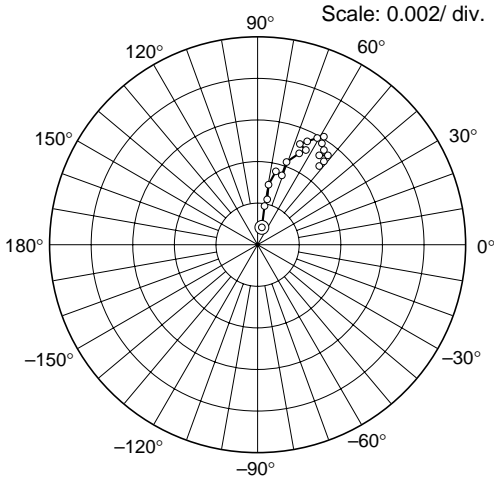

Condition: $V_{DS} = 4\text{ V}$, $V_{G2S} = 3\text{ V}$
 $I_D = 10\text{ mA}$, $Z_o = 50\ \Omega$
 100 to 1000 MHz (50 MHz step)



S22 Parameter vs. Frequency

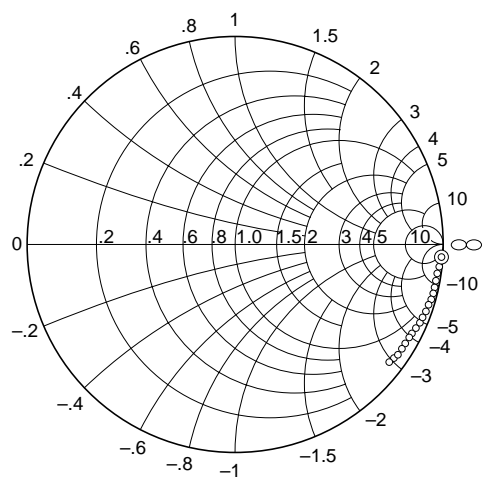

Condition: $V_{DS} = 4\text{ V}$, $V_{G2S} = 3\text{ V}$
 $I_D = 10\text{ mA}$, $Z_o = 50\ \Omega$
 100 to 1000 MHz (50 MHz step)



3SK321

S Parameter ($V_{DS} = 4\text{ V}$, $V_{G2S} = 3\text{ V}$, $I_D = 10\text{ mA}$, $Z_O = 50\ \Omega$)

Freq. (MHz)	S11		S21		S12		S22	
	MAG.	ANG.	MAG.	ANG.	MAG.	ANG.	MAG.	ANG.
100	0.999	-6.1	1.98	172.2	0.00094	79.2	0.989	-4.2
150	0.998	-9.1	1.97	168.4	0.00189	80.4	0.987	-6.1
200	0.992	-11.9	1.96	165.0	0.00230	79.5	0.986	-7.9
250	0.988	-14.8	1.96	161.0	0.00286	79.9	0.984	-9.8
300	0.985	-17.9	1.94	157.1	0.00364	75.2	0.981	-11.5
350	0.976	-20.6	1.92	153.7	0.00353	71.8	0.978	-13.4
400	0.971	-23.2	1.91	149.9	0.00419	70.7	0.975	-15.2
450	0.964	-26.3	1.88	146.8	0.00495	65.5	0.972	-17.2
500	0.961	-29.1	1.87	142.8	0.00509	62.7	0.968	-19.1
550	0.951	-32.2	1.86	139.4	0.00530	66.6	0.963	-20.8
600	0.949	-35.0	1.86	136.1	0.00550	63.8	0.960	-22.8
650	0.935	-37.6	1.81	132.9	0.00601	58.2	0.956	-24.5
700	0.933	-40.5	1.78	129.4	0.00582	60.6	0.950	-26.3
750	0.923	-42.9	1.77	125.7	0.00572	58.5	0.945	-28.0
800	0.916	-45.8	1.75	122.6	0.00553	56.3	0.941	-29.9
850	0.908	-49.0	1.72	119.1	0.00514	56.3	0.936	-31.7
900	0.900	-51.2	1.70	115.8	0.00543	52.9	0.930	-33.4
950	0.890	-54.0	1.67	112.6	0.00506	52.4	0.924	-35.2
1000	0.876	-56.4	1.65	109.3	0.00469	51.9	0.919	-37.0

Package Dimensions

Unit: mm

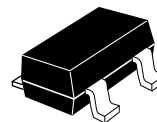
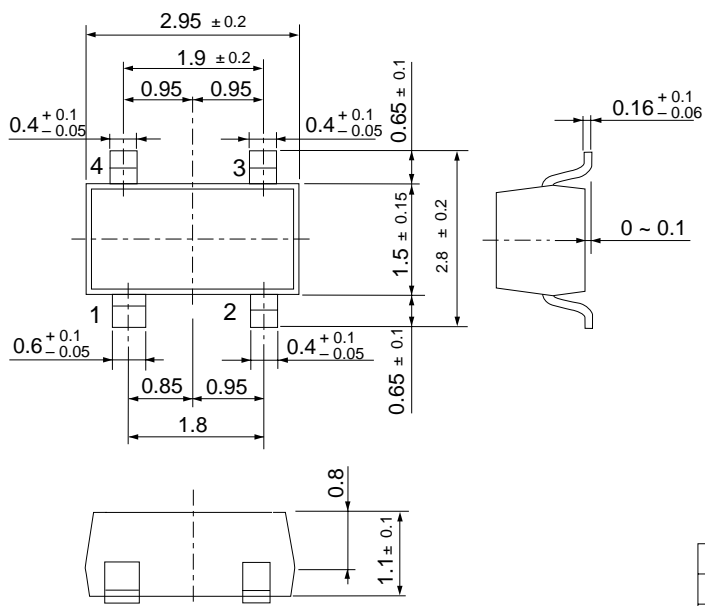

Hitachi Code	MPAK-4R
EIAJ	—
JEDEC	—

Cautions

1. Hitachi neither warrants nor grants licenses of any rights of Hitachi's or any third party's patent, copyright, trademark, or other intellectual property rights for information contained in this document. Hitachi bears no responsibility for problems that may arise with third party's rights, including intellectual property rights, in connection with use of the information contained in this document.
2. Products and product specifications may be subject to change without notice. Confirm that you have received the latest product standards or specifications before final design, purchase or use.
3. Hitachi makes every attempt to ensure that its products are of high quality and reliability. However, contact Hitachi's sales office before using the product in an application that demands especially high quality and reliability or where its failure or malfunction may directly threaten human life or cause risk of bodily injury, such as aerospace, aeronautics, nuclear power, combustion control, transportation, traffic, safety equipment or medical equipment for life support.
4. Design your application so that the product is used within the ranges guaranteed by Hitachi particularly for maximum rating, operating supply voltage range, heat radiation characteristics, installation conditions and other characteristics. Hitachi bears no responsibility for failure or damage when used beyond the guaranteed ranges. Even within the guaranteed ranges, consider normally foreseeable failure rates or failure modes in semiconductor devices and employ systemic measures such as fail-safes, so that the equipment incorporating Hitachi product does not cause bodily injury, fire or other consequential damage due to operation of the Hitachi product.
5. This product is not designed to be radiation resistant.
6. No one is permitted to reproduce or duplicate, in any form, the whole or part of this document without written approval from Hitachi.
7. Contact Hitachi's sales office for any questions regarding this document or Hitachi semiconductor products.

HITACHI

Hitachi, Ltd.

Semiconductor & Integrated Circuits.
Nippon Bldg., 2-6-2, Ohte-machi, Chiyoda-ku, Tokyo 100-0004, Japan
Tel: Tokyo (03) 3270-2111 Fax: (03) 3270-5109

URL North America : <http://semiconductor.hitachi.com/>
 Europe : <http://www.hitachi-eu.com/hel/ecg>
 Asia (Singapore) : <http://www.has.hitachi.com.sg/grp3/sicd/index.htm>
 Asia (Taiwan) : http://www.hitachi.com.tw/E/Product/SICD_Frame.htm
 Asia (HongKong) : <http://www.hitachi.com.hk/eng/bo/grp3/index.htm>
 Japan : <http://www.hitachi.co.jp/Sicd/indx.htm>

For further information write to:

Hitachi Semiconductor
(America) Inc.
179 East Tasman Drive,
San Jose, CA 95134
Tel: <1> (408) 433-1990
Fax: <1> (408) 433-0223

Hitachi Europe GmbH
Electronic components Group
Dornacher Straße 3
D-85622 Feldkirchen, Munich
Germany
Tel: <49> (89) 9 9180-0
Fax: <49> (89) 9 29 30 00

Hitachi Europe Ltd.
Electronic Components Group.
Whitebrook Park
Lower Cookham Road
Maidenhead
Berkshire SL6 8YA, United Kingdom
Tel: <44> (1628) 585000
Fax: <44> (1628) 778322

Hitachi Asia Pte. Ltd.
16 Collyer Quay #20-00
Hitachi Tower
Singapore 049318
Tel: 535-2100
Fax: 535-1533

Hitachi Asia Ltd.
Taipei Branch Office
3F, Hung Kuo Building, No.167,
Tun-Hwa North Road, Taipei (105)
Tel: <886> (2) 2718-3666
Fax: <886> (2) 2718-8180

Hitachi Asia (Hong Kong) Ltd.
Group III (Electronic Components)
7/F., North Tower, World Finance Centre,
Harbour City, Canton Road, Tsim Sha Tsui,
Kowloon, Hong Kong
Tel: <852> (2) 735 9218
Fax: <852> (2) 730 0281
Telex: 40815 HITEC HX

Copyright ' Hitachi, Ltd., 1999. All rights reserved. Printed in Japan.

HITACHI