

---

# 3SK322

Silicon N-Channel Dual Gate MOS FET

# HITACHI

ADE-208-712A (Z)  
2nd. Edition  
Dec. 1998

---

## Application

UHF / VHF RF amplifier

## Features

- Low noise figure.  
NF = 1.0 dB typ. at f = 200 MHz
- Capable of low voltage operation
- Provide mini mold packages; MPAK-4R(SOT-143 var.)

## Outline

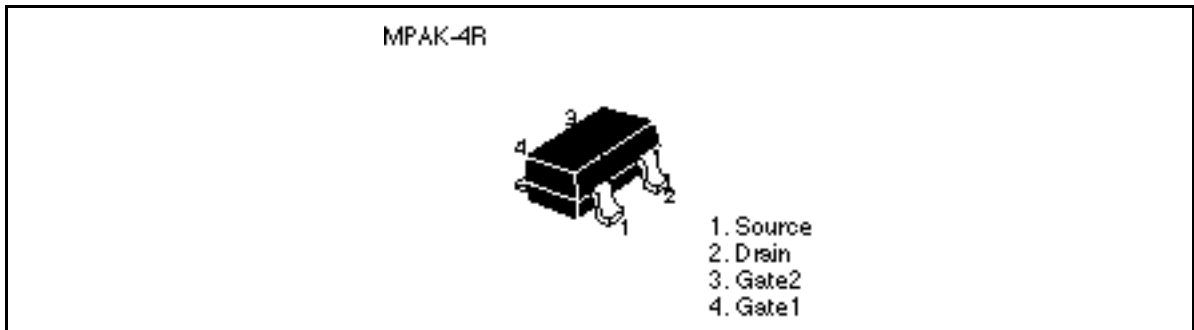

---

## 3SK322

---

### Absolute Maximum Ratings (Ta = 25°C)

Item	Symbol	Ratings	Unit
Drain to source voltage	$V_{DS}$	12	V
Gate 1 to source voltage	$V_{G1S}$	±8	V
Gate 2 to source voltage	$V_{G2S}$	±8	V
Drain current	$I_D$	25	mA
Channel power dissipation	Pch	150	mW
Channel temperature	Tch	150	°C
Storage temperature	Tstg	-55 to +150	°C

Attention: This device is very sensitive to electro static discharge.  
It is recommended to adopt appropriate cautions when handling this transistor.

## Electrical Characteristics (Ta = 25°C)

Item	Symbol	Min	Typ	Max	Unit	Test conditions
Drain to source breakdown voltage	$V_{(BR)DSX}$	12	—	—	V	$I_D = 200 \mu A$ , $V_{G1S} = -3 V$ , $V_{G2S} = -3 V$
Gate 1 to source breakdown voltage	$V_{(BR)G1SS}$	$\pm 8$	—	—	V	$I_{G1} = \pm 10 \mu A$ , $V_{G2S} = V_{DS} = 0$
Gate 2 to source breakdown voltage	$V_{(BR)G2SS}$	$\pm 8$	—	—	V	$I_{G2} = \pm 10 \mu A$ , $V_{G1S} = V_{DS} = 0$
Gate 1 cutoff current	$I_{G1SS}$	—	—	$\pm 100$	nA	$V_{G1S} = \pm 6 V$ , $V_{G2S} = V_{DS} = 0$
Gate 2 cutoff current	$I_{G2SS}$	—	—	$\pm 100$	nA	$V_{G2S} = \pm 6 V$ , $V_{G1S} = V_{DS} = 0$
Drain current	$I_{DS(on)}$	0.5	—	10	mA	$V_{DS} = 6 V$ , $V_{G1S} = 0.75 V$ , $V_{G2S} = 3 V$
Gate 1 to source cutoff voltage	$V_{G1S(off)}$	0	—	+1.0	V	$V_{DS} = 10 V$ , $V_{G2S} = 3 V$ , $I_D = 100 \mu A$
Gate 2 to source cutoff voltage	$V_{G2S(off)}$	0	—	+1.0	V	$V_{DS} = 10 V$ , $V_{G1S} = 3 V$ , $I_D = 100 \mu A$
Forward transfer admittance	$ y_{fs} $	16	20	—	mS	$V_{DS} = 6 V$ , $V_{G2S} = 3 V$ , $I_D = 10 mA$ , $f = 1 kHz$
Input capacitance	$C_{iss}$	2.4	2.9	3.4	pF	$V_{DS} = 6 V$ , $V_{G2S} = 3 V$ , $I_D = 10 mA$ , $f = 1 MHz$
Output capacitance	$C_{oss}$	0.8	1.0	1.4	pF	
Reverse transfer capacitance	$C_{rss}$	—	0.023	0.04	pF	
Power gain	PG	22	25	—	dB	$V_{DS} = 6 V$ , $V_{G2S} = 3 V$ , $I_D = 10 mA$ , $f = 200 MHz$
Noise figure	NF	—	1.0	1.8	dB	
Power gain	PG	12	15	—	dB	$V_{DS} = 6 V$ , $V_{G2S} = 3 V$ , $I_D = 10 mA$ , $f = 900 MHz$
Noise figure	NF	—	3.2	4.5	dB	
Noise figure	NF	—	2.8	3.5	dB	$V_{DS} = 6 V$ , $V_{G2S} = 3 V$ , $I_D = 10 mA$ , $f = 60 MHz$

Note: Marking is "ZW—"

Main Characteristics

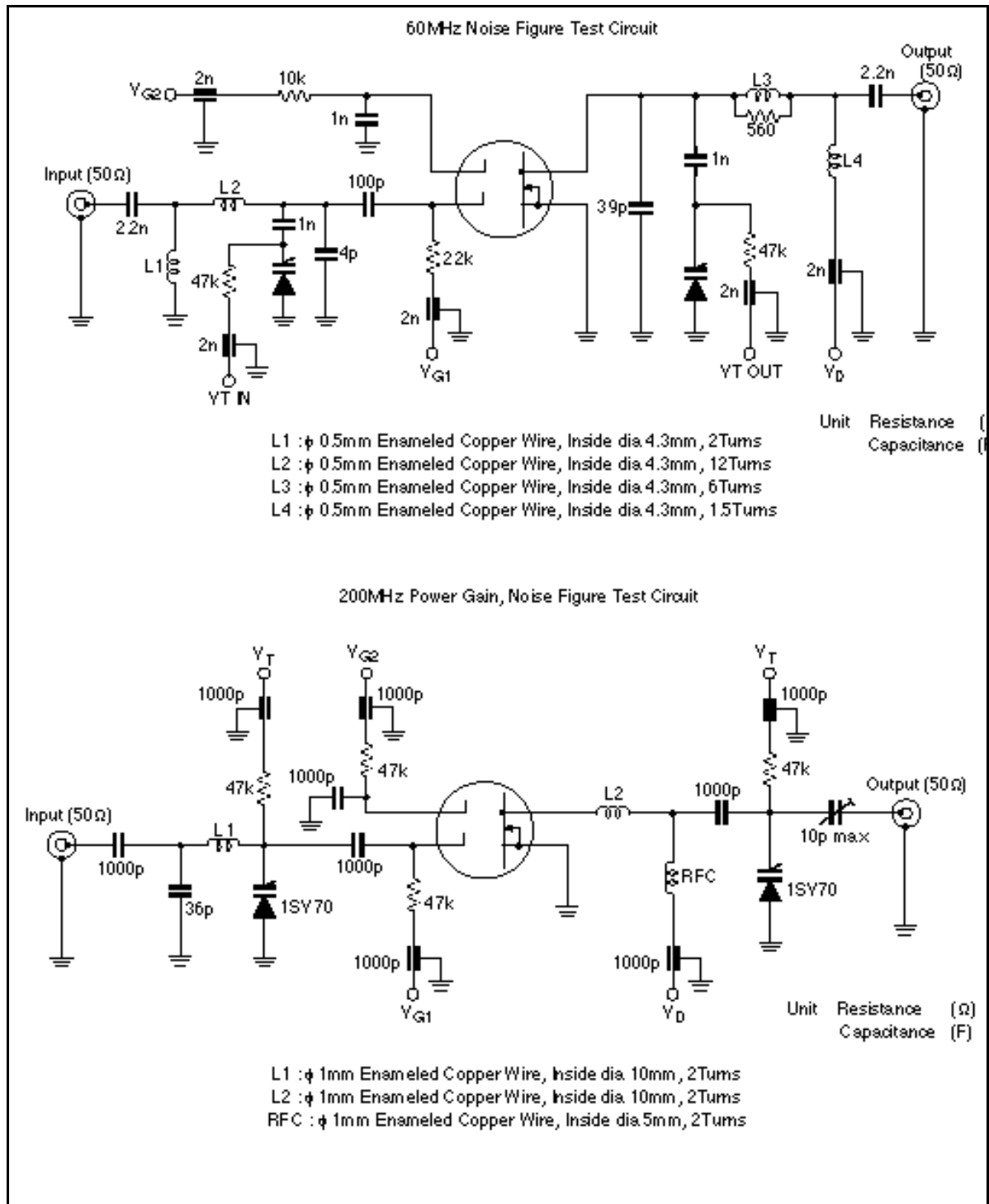

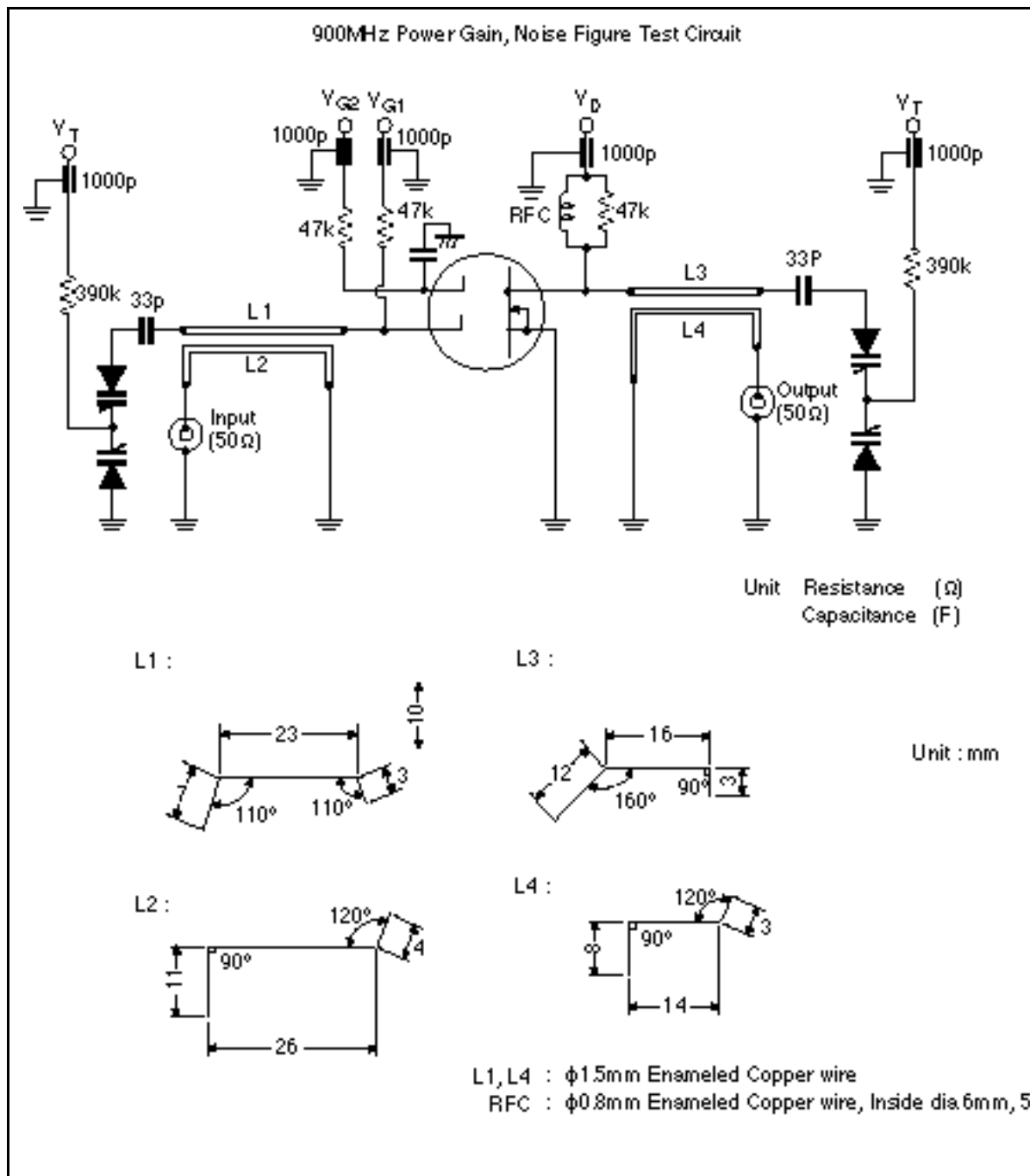

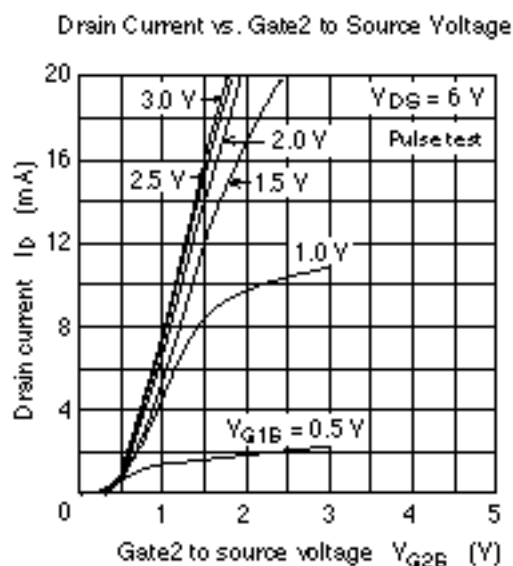
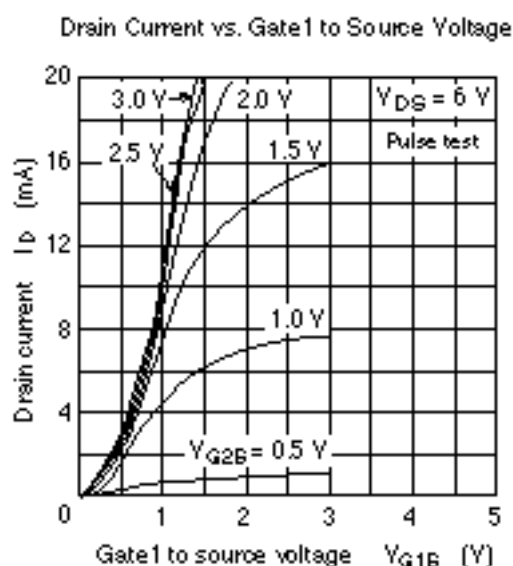
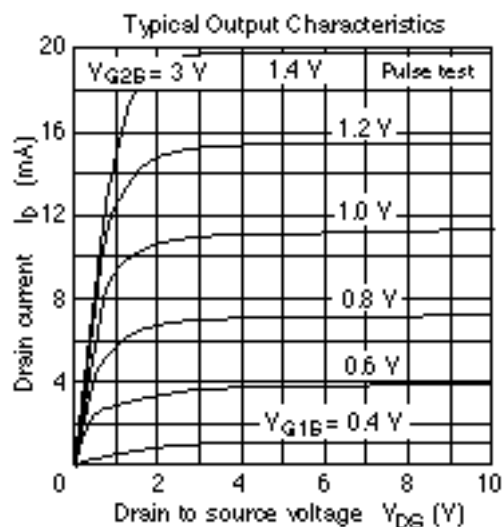
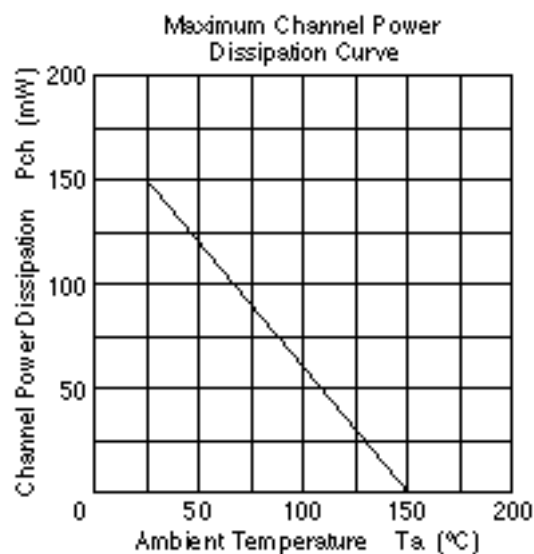

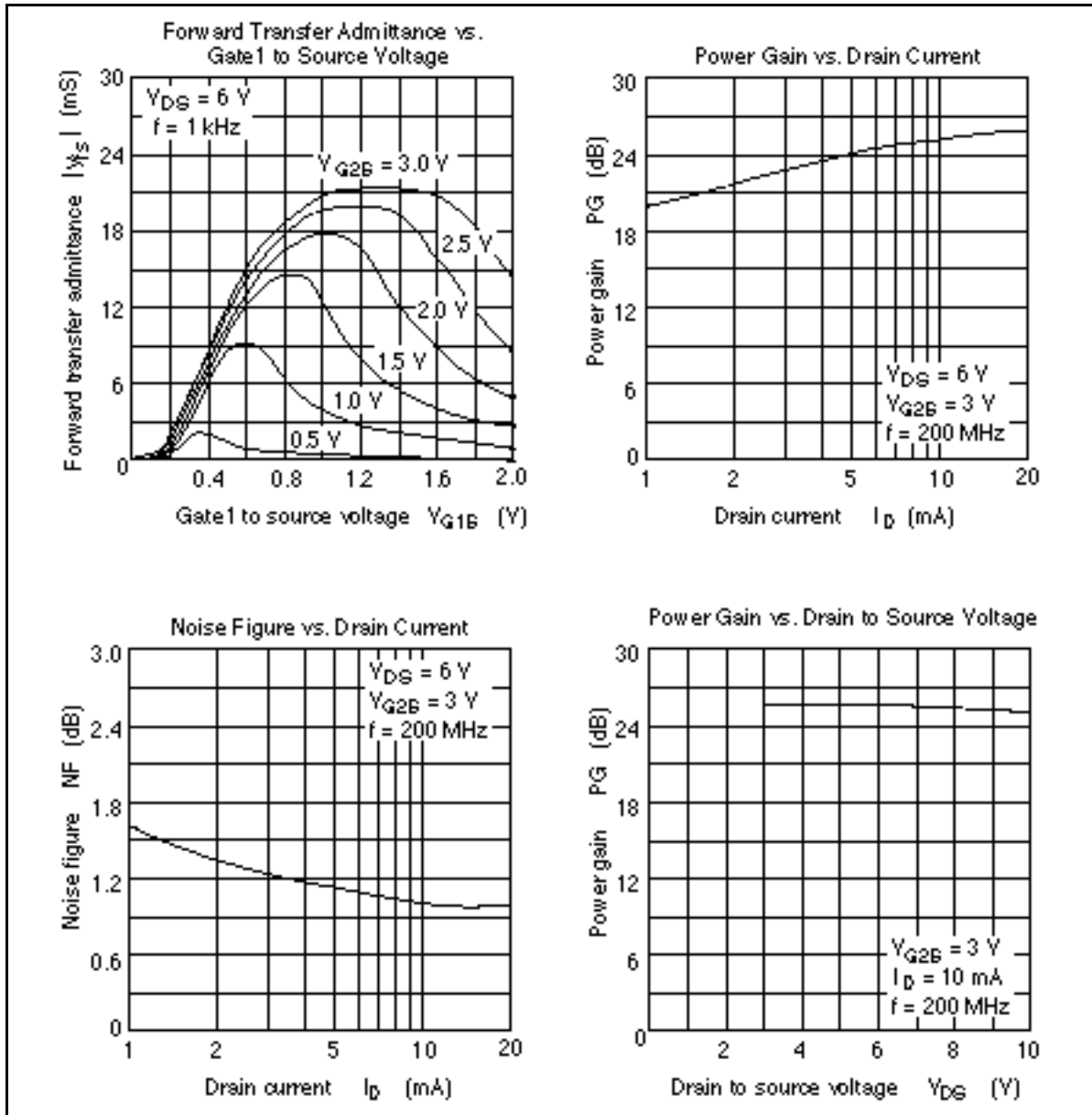

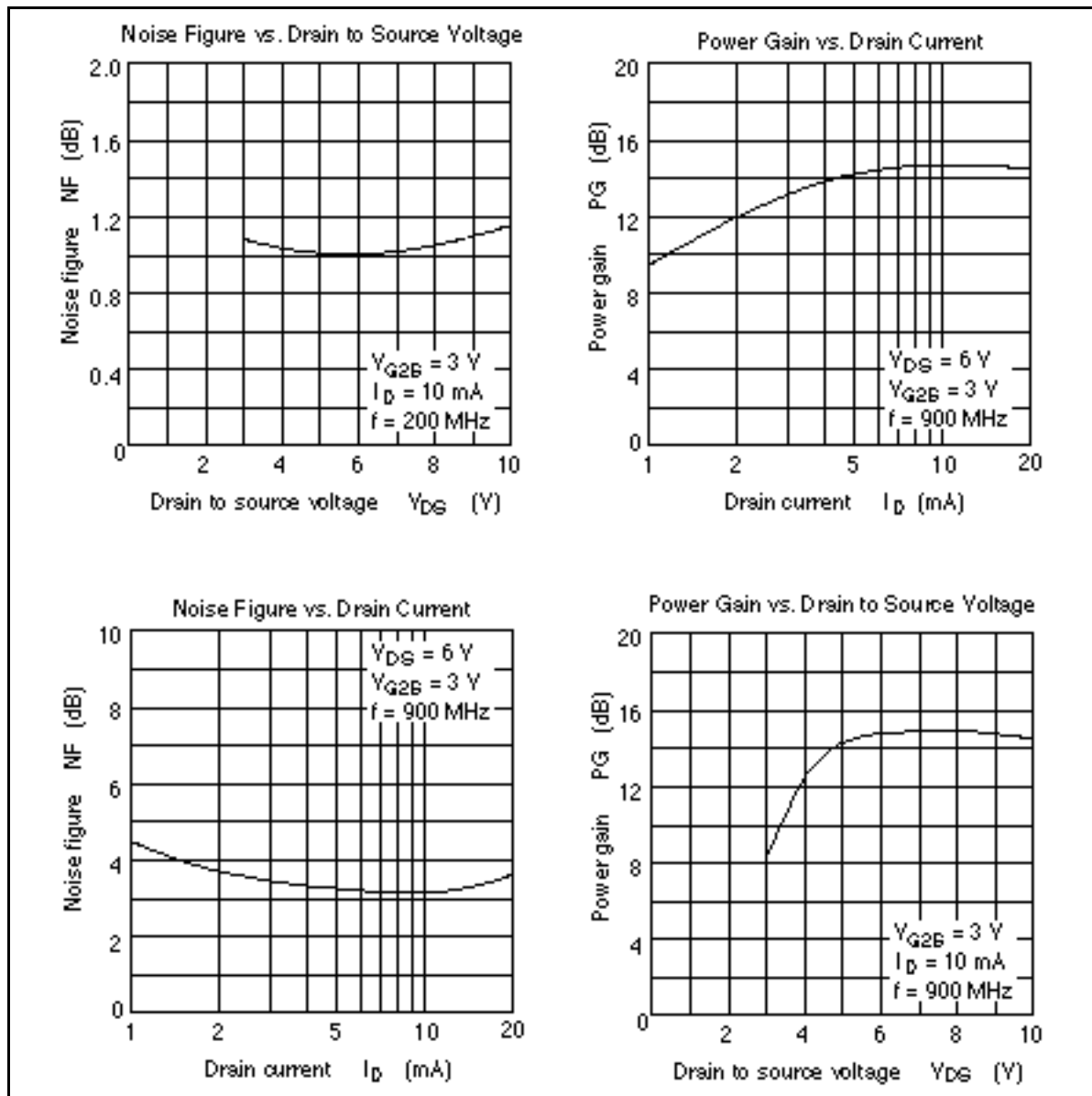



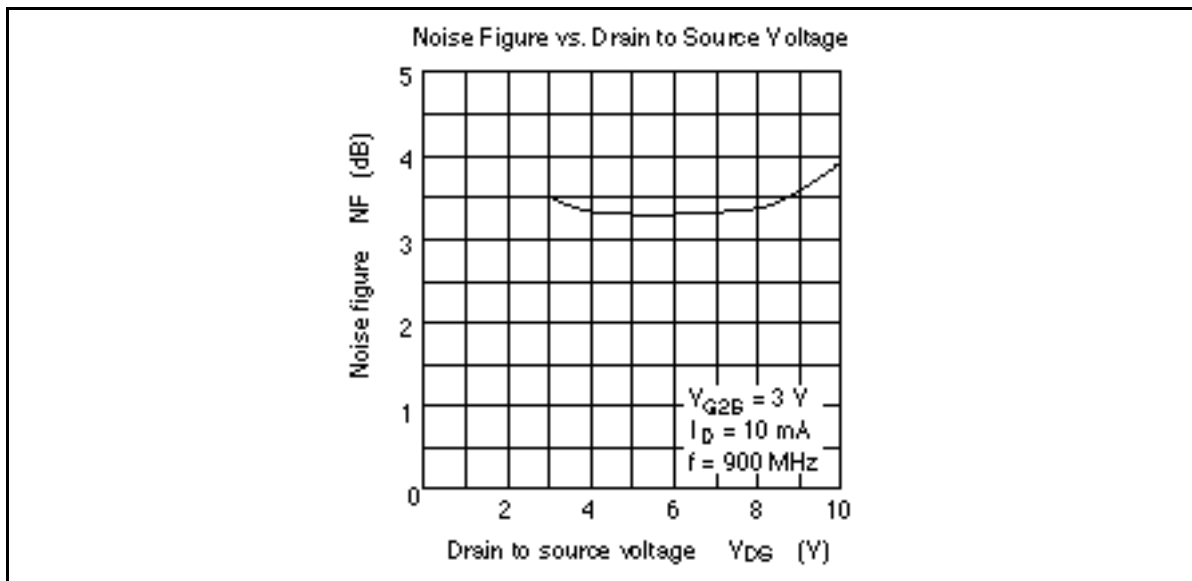

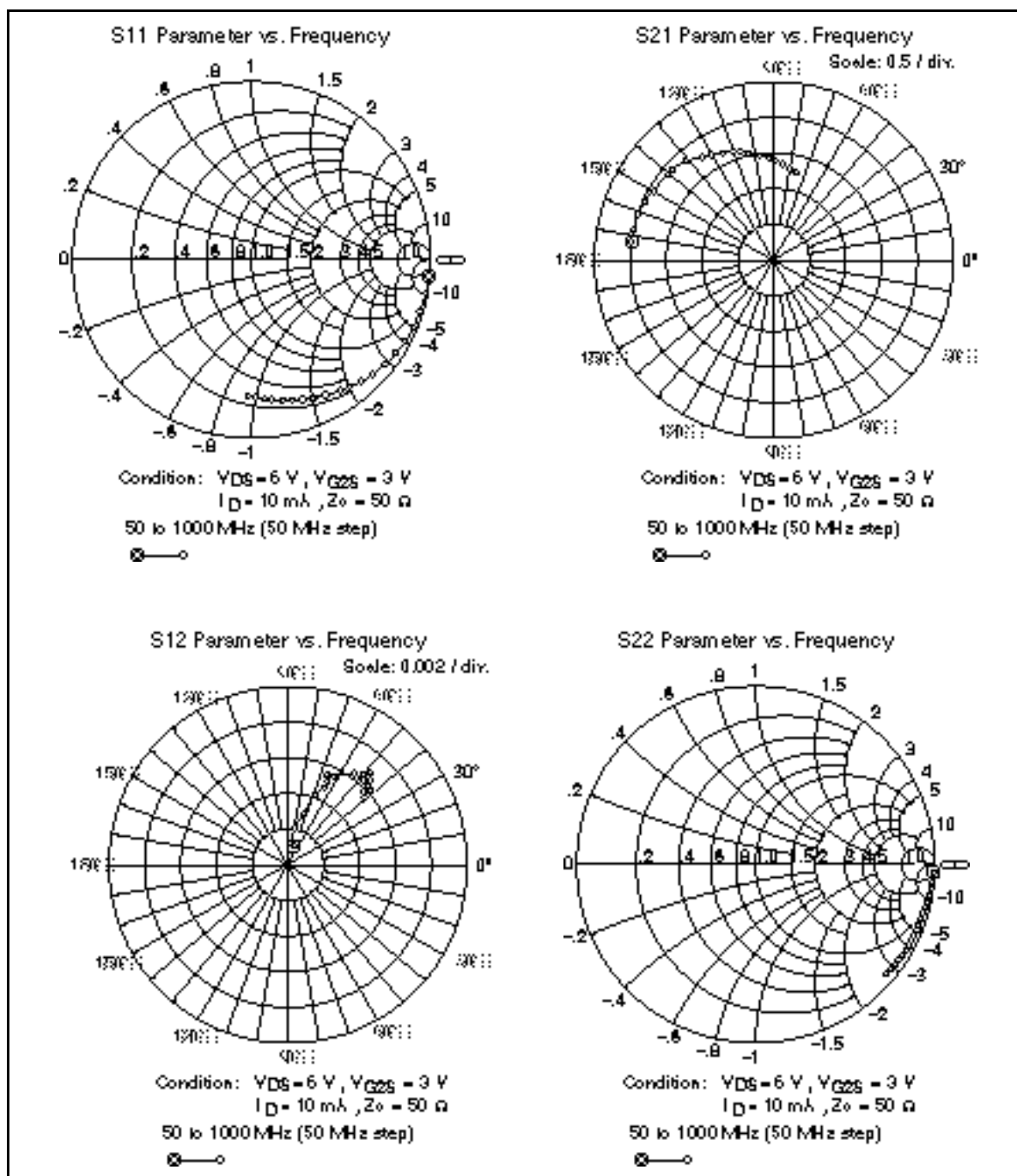

**S Parameter** ( $V_{DS} = 6 \text{ V}$ ,  $V_{G2S} = 3 \text{ V}$ ,  $I_D = 10 \text{ mA}$ ,  $Z_0 = 50 \text{ } \Omega$ )

Freq. (MHz)	S11		S21		S12		S22	
	MAG.	ANG.	MAG.	ANG.	MAG.	ANG.	MAG.	ANG.
50	0.994	-5.8	2.04	173.6	0.00116	76.9	0.993	-2.2
100	0.993	-11.0	2.02	167.4	0.00132	85.7	0.993	-4.5
150	0.986	-16.8	2.00	161.5	0.00229	78.2	0.991	-6.4
200	0.980	-22.5	1.98	155.5	0.00313	73.5	0.990	-8.5
250	0.973	-27.8	1.94	149.6	0.00427	68.7	0.987	-10.5
300	0.950	-33.0	1.90	142.6	0.00473	63.9	0.985	-12.5
350	0.936	-38.3	1.86	137.1	0.00536	64.3	0.982	-14.4
400	0.924	-43.4	1.83	131.6	0.00561	64.5	0.979	-16.2
450	0.912	-48.0	1.77	126.8	0.00562	60.9	0.975	-18.2
500	0.893	-52.5	1.71	121.0	0.00640	53.5	0.971	-20.2
550	0.874	-57.3	1.67	115.5	0.00638	49.3	0.967	-22.0
600	0.859	-62.0	1.64	111.1	0.00647	49.0	0.964	-23.9
650	0.846	-66.1	1.58	106.7	0.00667	50.2	0.960	-25.8
700	0.829	-69.8	1.50	102.1	0.00694	49.3	0.955	-27.6
750	0.810	-74.2	1.46	97.1	0.00661	46.6	0.952	-29.4
800	0.802	-78.0	1.44	92.7	0.00618	43.7	0.948	-31.2
850	0.791	-81.6	1.38	88.9	0.00622	44.7	0.944	-33.2
900	0.778	-84.6	1.34	84.2	0.00615	43.6	0.940	-35.1
950	0.756	-88.5	1.30	80.2	0.00576	45.1	0.935	-36.8
1000	0.751	-92.2	1.26	75.9	0.00562	40.7	0.932	-38.5

**Cautions**

1. Hitachi neither warrants nor grants licenses of any rights of Hitachi's or any third party's patent, copyright, trademark, or other intellectual property rights for information contained in this document. Hitachi bears no responsibility for problems that may arise with third party's rights, including intellectual property rights, in connection with use of the information contained in this document.
2. Products and product specifications may be subject to change without notice. Confirm that you have received the latest product standards or specifications before final design, purchase or use.
3. Hitachi makes every attempt to ensure that its products are of high quality and reliability. However, contact Hitachi's sales office before using the product in an application that demands especially high quality and reliability or where its failure or malfunction may directly threaten human life or cause risk of bodily injury, such as aerospace, aeronautics, nuclear power, combustion control, transportation, traffic, safety equipment or medical equipment for life support.
4. Design your application so that the product is used within the ranges guaranteed by Hitachi particularly for maximum rating, operating supply voltage range, heat radiation characteristics, installation conditions and other characteristics. Hitachi bears no responsibility for failure or damage when used beyond the guaranteed ranges. Even within the guaranteed ranges, consider normally foreseeable failure rates or failure modes in semiconductor devices and employ systemic measures such as fail-safes, so that the equipment incorporating Hitachi product does not cause bodily injury, fire or other consequential damage due to operation of the Hitachi product.
5. This product is not designed to be radiation resistant.
6. No one is permitted to reproduce or duplicate, in any form, the whole or part of this document without written approval from Hitachi.
7. Contact Hitachi's sales office for any questions regarding this document or Hitachi semiconductor products.

---

---

**HITACHI**

Hitachi, Ltd.

Semiconductor &amp; IC Div.

Nippon Bldg., 2-6-2, Ohite-machi, Chiyoda-ku, Tokyo 100-0004, Japan

Tel: Tokyo (03) 5270-2111 Fax: (03) 5270-5109

URL	North America	: <a href="http://semiconductor.hitachi.com/">http://semiconductor.hitachi.com/</a>
	Europe	: <a href="http://www.hitachi-eu.com/hel/eog">http://www.hitachi-eu.com/hel/eog</a>
	Asia (Singapore)	: <a href="http://www.hias.hitachi.com_sg/grp3/sicd/index.htm">http://www.hias.hitachi.com_sg/grp3/sicd/index.htm</a>
	Asia (Taiwan)	: <a href="http://www.hitachi.com_tw/E/Product/IC/D_Frame.htm">http://www.hitachi.com_tw/E/Product/IC/D_Frame.htm</a>
	Asia (HongKong)	: <a href="http://www.hitachi.com_hk/eng/bol/grp3/index.htm">http://www.hitachi.com_hk/eng/bol/grp3/index.htm</a>
	Japan	: <a href="http://www.hitachi.co.jp/Sicd/index.htm">http://www.hitachi.co.jp/Sicd/index.htm</a>

For further information write to:

Hitachi Semiconductor  
(America) Inc.  
3000 Stone Point Parkway  
Brea, CA 94005-1807  
Tel: +1 (800) 285-1801  
Fax: +1 (505) 297-0447

Hitachi Europe GmbH  
Electronic Components Group  
Domacher StraÙe 3  
D-85622 Feldkirchen, Munich  
Germany  
Tel: +49 (89) 9 9180-0  
Fax: +49 (89) 9 29 30 00

Hitachi Europe Ltd.  
Electronic Components Group  
Whitebrook Park  
Lower Cookham Road  
Maidenhead  
Berkshire SL6 8YX, United Kingdom  
Tel: +44 (1628) 526000  
Fax: +44 (1628) 77822

Hitachi Asia Pte Ltd.  
15 Collyer Quay #20-00  
Hitachi Tower  
Singapore 049318  
Tel: 525-2100  
Fax: 525-1533

Hitachi Asia Ltd.  
Taipei Branch Office  
3F, Hung Kuo Building, No.167,  
Tun-Hua North Road, Taipei (105)  
Tel: +886 (2) 2718-3685  
Fax: +886 (2) 2718-3180

Hitachi Asia (Hong Kong) Ltd.  
Group III (Electronic Components)  
7/F, North Tower, World Finance Centre,  
Harbour City, Canton Road, Tsim Sha Tsui,  
Kowloon, Hong Kong  
Tel: +852 (2) 735 9818  
Fax: +852 (2) 730 0881  
Telex: 40815 HITECHX

Copyright © Hitachi, Ltd., 1998. All rights reserved. Printed in Japan.