

















3TF AC Contactors









Selection and ordering data									
AC operation									
		3TF30		3TF40		3TF31		3TF41	
Auxiliary contacts NO NC									
		NO - NC		NO - NC		NO - NC		NO - NC	
Order No.		3TF30 00 - OX 3TF30 10 - OX 3TF30 01 - OX		3TF40 10 - OX 3TF40 01 - OX 3TF40 11 - OX 3TF40 22 - OX 3TF40 20 - OX 3TF40 31 - OX		3TF31 00 - OX 3TF31 10 - OX 3TF31 01 - OX		3TF41 10 - OX 3TF41 01 - OX 3TF41 11 - OX 3TF41 22 - OX 3TF41 20 - OX 3TF41 31 - OX	
		- - 1 - - 1		- - - 1 1 1 2 2 2 - 3 1		- - 1 - - 1		1 - - 1 1 1 2 2 2 - 3 1	
Rated insulation voltage (V)		690		690		690		690	
Rated operational current (380V)		AC - 3 AC - 4		9 3.3		9 3.3		12 4.3	
Rated outputs of three-phase motors at 50Hz (KW)		AC - 3 AC - 4		230/220V 400/380V 500 V 690/660V 1000 V		2.4 4 5.5 5.5 --		2.4 4 5.5 5.5 --	
		400/380V 690/660V		1.48/1.4 2.54/2.4		1.48/1.4 2.54/2.4		2/1.9 3.45/3.3	
Mechanical endurance (x10 ⁶)		15		15		15		15	
Electrical endurance (x10 ⁶)		AC - 3 AC - 4		1.2 0.2		1.2 0.2		1.2 0.2	
Switching frequency (1/h)		AC - 3 AC - 4		1000 250		1000 250		1000 250	
Coil voltage tolerance (AC)		(0.8~1.1)U _n							
Order No. suffixes for rated control voltages for coils		Coils for 50Hz			Coils for 60Hz			Coils for 50/60Hz	
		50Hz 60Hz		60Hz 50Hz					
3TF3...OX □□		24V 29V		24V 20V		C1		24V C2	
3TF4...OX □□		32V 38V		110V 92V		G1		42V D2	
		36V 42V		115V 96V		J1		110V G2	
		42V 50V		120V 100V		K1		115V J2	
		48V 58V		208V 173V		M1		120V K2	
		60V 72V		220V 183V		N1		208V M2	
		110V 132V		230V 192V		L1		220V N2	
		125/127V 150/152V		240V 200V		P1		230V L2	
		220V 264V		440V 367V		R1		240V P2	
		230V 277V		575V 480V		S1		440V R2	
		240V 288V						575V S2	
		380V 460V							
		400V 480V							
		415V 500V							
		500V 600V							
Power consumption of coil (50Hz)		Closed (VA)		10		10		10	
		p.f.		0.29		0.29		0.29	
		Closed (VA)		68		68		68	
		p.f.		0.82		0.82		0.82	
Conventional thermal current (A)		20		20		20		20	
Conventional thermal current of auxiliary contacts		10		10		10		10	
Rated insulation voltage of auxiliary contacts		690		690		690		690	
Rated operational current of auxiliary contacts (A)		AC - 15 380/220V		6/10		6/10		6/10	
		DC - 13 110/220V		0.9/0.45		0.9/0.45		0.9/0.45	
Weight (kg)		0.37		0.43		0.37		0.43	

Note: 3TX4 auxiliary contact blocks for 3TF3 series, see P2/16.









Selection and ordering data									
AC operation									
		3TF32		3TF42		3TF33		3TF43	
Auxiliary contacts NO NC									
		NO - NC		NO - NC		NO - NC		NO - NC	
Order No.		3TF32 00 - 0X 3TF32 11 - 0X	- - 1 1	3TF42 10 - 0X 3TF42 11 - 0X 3TF42 20 - 0X 3TF42 22 - 0X	1 - 1 1 2 - 2 2	3TF33 00 - 0X 3TF33 11 - 0X	- - 1 1	3TF43 10 - 0X 3TF43 11 - 0X 3TF43 20 - 0X 3TF43 22 - 0X	1 - 1 1 2 - 2 2
Rated insulation voltage (V)		690		690		690		690	
Rated operational current (A) (380V)		AC - 3	16	AC - 3	16	AC - 3	22	AC - 3	22
		AC - 4	7.7	AC - 4	7.7	AC - 4	8.5	AC - 4	8.5
Rated outputs of three-phase motors at 50Hz (KW)		AC - 3	230/220V 400/380V 500 V 690/660V 1000 V	4 7.5 9 11 --	4 7.5 9 11 --	5.5 11 11 11 --	5.5 11 11 11 --	5.5 11 11 11 --	5.5 11 11 11 --
		AC - 4	400/380V 690/660V	3.5 6	3.5 6	4 6.6	4 6.6	4 6.6	4 6.6
Mechanical endurance (x10 ⁶)		15		15		15		15	
Electrical endurance (x10 ⁶)		AC - 3	1.2	AC - 3	1.2	AC - 3	1.2	AC - 3	1.2
		AC - 4	0.2	AC - 4	0.2	AC - 4	0.2	AC - 4	0.2
Switching frequency (1/h)		AC - 3	750	AC - 3	750	AC - 3	750	AC - 3	750
		AC - 4	250	AC - 4	250	AC - 4	250	AC - 4	250
Coil voltage tolerance (AC)		(0.8-1.1)U _s							
Order No. suffixes for rated control voltages for coils		Coils for 50Hz			Coils for 60Hz			Coils for 50/60Hz	
		50Hz	60Hz		60Hz	50Hz			
3TF3...-0X <input type="checkbox"/>		24V	29V	B0	24V	20V	C1	24V	C2
3TF4...-0X <input type="checkbox"/>		32V	38V	C0	110V	92V	G1	42V	D2
		36V	42V	G0	115V	96V	J1	110V	G2
		42V	50V	D0	120V	100V	K1	115V	J2
		48V	58V	H0	208V	173V	M1	120V	K2
		60V	72V	E0	220V	183V	N1	208V	M2
		110V	132V	F0	230V	192V	L1	220V	N2
		125/127V	150/152V	L0	240V	200V	P1	230V	L2
		220V	264V	M0	440V	367V	R1	240V	P2
		230V	277V	P0	575V	480V	S1	440V	R2
		240V	288V	U0				575V	S2
		380V	460V	Q0					
		400V	480V	V0					
		415V	500V	R0					
		500V	600V	S0					
Power consumption of coil (50Hz)		Closed (VA)	10		10		10		10
		p.f.	0.29		0.29		0.29		0.29
		Closing (VA)	68		68		68		68
		p.f.	0.82		0.82		0.82		0.82
Conventional thermal current (A)		30		30		30		30	
Conventional thermal current of auxiliary contacts		10		10		10		10	
Rated insulation voltage of auxiliary contacts		690		690		690		690	
Rated operational current of auxiliary contacts (A)		AC - 15 380/220V	4/6		6/10		4/6		6/10
		DC - 13 110/220V	1.14/0.48		0.9/0.45		1.14/0.48		0.9/0.45
Weight (kg)		0.45		0.49		0.45		0.49	

Note: 3TX4 auxiliary contact blocks for 3TF3 series, see P2/16









3TF AC Contactors







Selection and ordering data									
AC operation									
		3TF34		3TF44		3TF35		3TF45	
Auxiliary contacts NO NC									
		NO - NC		NO - NC		NO - NC		NO - NC	
Order No.		3TF34 00 - 0X 3TF34 11 - 0X		3TF44 11 - 0X 3TF44 22 - 0X		3TF35 00 - 0X 3TF35 11 - 0X		3TF45 11 - 0X 3TF45 22 - 0X	
		- - 1 1		1 1 2 2		- - 1 1		1 1 2 2	
Rated insulation voltage (V)		690		690		690		690	
Rated operational current (A) (380V)		AC - 3 AC - 4		32 15.6		32 15.6		38 18.5	
Rated outputs of three-phase motors at 50Hz (kW)		AC - 3 AC - 4		230/220V 400/380V 500 V 690/660V 1000 V		8.5 15 21 23 --		8.5 15 21 23 --	
		400/380V 690/660V		7.5 13		7.5 13		9 15.5	
Mechanical endurance (x10 ⁶)		10		10		10		10	
Electrical endurance (x10 ⁶)		AC - 3 AC - 4		1.2 0.2		1.2 0.2		1.2 0.2	
Switching frequency (1/h)		AC - 3 AC - 4		750 250		750 250		600 200	
Coil voltage tolerance (AC)		(0.8~1.1)U _s							
Order No. suffixes for rated control voltages for coils		Coils for 50Hz		Coils for 60Hz			Coils for 50/60Hz		
		50Hz 60Hz		60Hz 50Hz					
3TF3...-0X <input type="checkbox"/>		24V 29V B0		24V 20V C1			24V C2		
3TF4...-0X <input type="checkbox"/>		32V 38V C0		110V 92V G1			42V D2		
		36V 42V G0		115V 96V J1			110V G2		
		42V 50V D0		120V 100V K1			115V J2		
		48V 58V H0		208V 173V M1			120V K2		
		60V 72V E0		220V 183V N1			208V M2		
		110V 132V F0		230V 192V L1			220V N2		
		125/127V 150/152V L0		240V 200V P1			230V L2		
		220V 264V M0		440V 367V R1			240V P2		
		230V 277V P0		575V 480V S1			440V R2		
		240V 288V U0					575V S2		
		380V 460V Q0							
		400V 480V V0							
		415V 500V R0							
		500V 600V S0							
Power consumption of coil (50Hz)		Closed (VA)		12.1		12.1		12.1	
		p.f.		0.28		0.28		0.28	
		Closing (VA)		101		101		101	
		p.f.		0.83		0.83		0.83	
Conventional thermal current (A)		55		55		55		55	
Conventional thermal current of auxiliary contacts (A)		10		10		10		10	
Rated insulation voltage of auxiliary contacts (V)		690		690		690		690	
Rated operational current of auxiliary contacts (A)		AC - 15 380/220V		4/6		4/6		4/6	
		DC - 13 110/220V		1.14/0.48		1.14/0.48		1.14/0.48	
Weight (kg)		0.68		0.8		0.68		0.8	

Note: 3TX4 auxiliary contact blocks for 3TF3 series, see P2/16.









Selection and ordering data									
AC operation									
		3TF46		3TF47		3TF48		3TF49	
Auxiliary contacts NO NC									
		NO - NC		NO - NC		NO - NC		NO - NC	
Order No.		3TF46 22 - 0X 3TF46 44 - 0X		3TF47 22 - 0X 3TF47 44 - 0X		3TF48 22 - 0X 3TF48 44 - 0X		3TF49 22 - 0X 3TF49 44 - 0X	
		2 2 4 4		2 2 4 4		2 2 4 4		2 2 4 4	
Rated insulation voltage (V)		1000		1000		1000		1000	
Rated operational current (A) (380V)		AC - 3 AC - 4		45 24		63 28		75 34	
Rated outputs of three-phase motors at 50Hz (KW)		230/220V 400/380V AC - 3 500 V 690/660V 1000 V		15 22 30 39 7.5		18.5 30 41 55 7.5		22 37 50 67 39	
		AC - 4 400/380V 690/660V		12.6/12 21.8/20.8		14.7/14 25.4/24.3		17.9/17 30.9/29.5	
Mechanical endurance (x10 ⁶)		10		10		10		10	
Electrical endurance (x10 ⁶)		AC - 3 AC - 4		1.2 0.2		1.2 0.2		1.2 0.2	
Switching frequency (1/h)		AC - 3 AC - 4		1200 400		1000 300		1000 250	
Coil voltage tolerance (AC)		(0.8~1.1)U _s							
Order No. suffixes for rated control voltages for coils		Coils for 50Hz			Coils for 60Hz			Coils for 50/60Hz	
		50Hz	60Hz		60Hz	50Hz			
3TF46-..0X□□		24V	29V	B0	24V	20V	C1	24V	C2
3TF49-..0X□□		32V	38V	C0	110V	92V	G1	42V	D2
		36V	42V	G0	115V	96V	J1	110V	G2
		42V	50V	D0	120V	100V	K1	115V	J2
		48V	58V	H0	208V	173V	M1	120V	K2
		60V	72V	E0	220V	183V	N1	208V	M2
		110V	132V	F0	230V	192V	L1	220V	N2
		125/127V	150/152V	L0	240V	200V	P1	230V	L2
		220V	264V	M0	440V	367V	R1	240V	P2
		230V	277V	P0	575V	480V	S1	440V	R2
		240V	288V	U0				575V	S2
		380V	460V	Q0					
		400V	480V	V0					
		415V	500V	R0					
		500V	600V	S0					
Power consumption of coil (50Hz)		Closed (VA)		17		17		32	
		p.f.		0.29		0.29		0.23	
		Closing (VA)		183		183		330	
		p.f.		0.6		0.6		0.5	
Conventional thermal current (A)		80		90		100		100	
Conventional thermal current of auxiliary contacts (A)		10		10		10		10	
Rated insulation voltage of auxiliary contacts (V)		690		690		690		690	
Rated operational current of auxiliary contacts (A)		AC - 15 380/220V		4/6		4/6		4/6	
		DC - 13 110/220V		1.14/0.48		1.14/0.48		1.14/0.48	
Weight (kg)		1.4/1.6		1.4/1.6		2.3/2.5		2.3/2.5	

3TF AC Contactors









Selection and ordering data													
AC operation													
		3TF50		3TF51		3TF52		3TF53					
Auxiliary contacts NO NC													
		NO - NC		NO - NC		NO - NC		NO - NC					
Order No.		3TF50 22 - 0X 3TF50 44 - 0X		3TF51 22 - 0X 3TF51 44 - 0X		3TF52 22 - 0X 3TF52 44 - 0X		3TF53 22 - 0X 3TF53 44 - 0X					
		2 2 4 4		2 2 4 4		2 2 4 4		2 2 4 4					
Rated insulation voltage (V)		1000		1000		1000		1000					
Rated operational current (A) (380V)		AC - 3 AC - 4		110 54		140 68		170 75		205 96			
Rated outputs of three-phase motors at 50Hz (KW)		AC - 3 AC - 4		230/220V 400/380V 500 V 690/660V 1000 V		37 55 76 100 65		43 75 98 100 65		55 90 118 156 90		64 110 145 156 90	
		400/380V 690/660V		28.4/27 49/46.9		36/35 63/60		40/38 69/66		52/50 90/86			
Mechanical endurance (x10 ⁶)		10		10		10		10					
Electrical endurance (x10 ⁶)		AC - 3 AC - 4		1.2 0.2		1.2 0.2		1.2 0.2		1.2 0.2			
Switching frequency (1/h)		AC - 3 AC - 4		1000 300		750 200		700 200		500 130			
Coil voltage tolerance (AC)		(0.8~1.1)U _s											
Order No. suffixes for rated control voltages for coils		Coils for 50Hz			Coils for 60Hz			Coils for 50/60Hz					
		50Hz		60Hz		60Hz		50Hz					
3TF50...0X□□		24V	29V	B0	24V	20V	C1	24V	C2				
		32V	38V	C0	110V	92V	G1	42V	D2				
		36V	42V	G0	115V	96V	J1	110V	G2				
		42V	50V	D0	120V	100V	K1	115V	J2				
3TF53...0X□□		48V	58V	H0	208V	173V	M1	120V	K2				
		60V	72V	E0	220V	183V	N1	208V	M2				
		110V	132V	F0	230V	192V	L1	220V	N2				
		125/127V	150/152V	L0	240V	200V	P1	230V	L2				
		220V	264V	M0	440V	367V	R1	240V	P2				
		230V	277V	P0	575V	480V	S1	440V	R2				
		240V	288V	U0				575V	S2				
		380V	460V	Q0									
		400V	480V	V0									
		415V	500V	R0									
		500V	600V	S0									
Power consumption of coil (50Hz)		Closed (VA)		39		39		58		58			
		p.f.		0.24		0.24		0.26		0.26			
		Closing (VA)		550		550		910		910			
		p.f.		0.45		0.45		0.38		0.38			
Conventional thermal current (A)		160		160		210		220					
Conventional thermal current of auxiliary contacts (A)		10		10		10		10					
Rated insulation voltage of auxiliary contacts (V)		690		690		690		690					
Rated operational current of auxiliary contacts (A)		AC - 15 380/220V		4/6		4/6		4/6		4/6			
		DC - 13 110/220V		1.14/0.48		1.14/0.48		1.14/0.48		1.14/0.48			
Weight (kg)		3.3/3.5		3.3/3.5		4.8/5.0		4.8/5.0					

Selection and ordering data								
AC operation								
	3TF54		3TF55		3TF56			
Auxiliary contacts NO NC								
	NO - NC		NO - NC		NO - NC			
Order No.	3TF54 22 - 0X 3TF54 44 - 0X	2 2 4 4	3TF55 22 - 0X 3TF55 44 - 0X	2 2 4 4	3TF56 22 - 0X 3TF56 44 - 0X	2 2 4 4		
Rated insulation voltage (V)	1000		1000		1000			
Rated operational current (A) (380V)	AC - 3	250	300		400			
	AC - 4	110	125		150			
Rated outputs of three-phase motors at 50Hz (KW)	AC - 3	230/220V	78		93			
		400/380V	132		160			
		500 V	178		210			
	AC - 4	690/660V	235		235			
		1000 V	132		132			
		400/380V 690/660V	61/58 105/100		69/66 119/114		85/81 147/140	
Mechanical endurance (x10 ⁶)	10		10		10			
Electrical endurance (x10 ⁶)	AC - 3	1.2		1.2		1.2		
	AC - 4	0.2		0.2		0.2		
Switching frequency (1/h)	AC - 3	700		500		500		
	AC - 4	200		130		150		
Coil voltage tolerance (AC)	(0.8-1.1)U _s							
Order No. suffixes for rated control voltages for coils	Coils for 50Hz		Coils for 60Hz			Coils for 50/60Hz		
	50Hz	60Hz	60Hz	50Hz				
3TF54...-0X□□	24V	29V	B0	24V	20V	C1	24V	C2
	32V	38V	C0	110V	92V	G1	42V	D2
	36V	42V	G0	115V	96V	J1	110V	G2
	42V	50V	D0	120V	100V	K1	115V	J2
3TF56...-0X□□	48V	58V	H0	208V	173V	M1	120V	K2
	60V	72V	E0	220V	183V	N1	208V	M2
	110V	132V	F0	230V	192V	L1	220V	N2
	125/127V	150/152V	L0	240V	200V	P1	230V	L2
	220V	264V	M0	440V	367V	R1	240V	P2
	230V	277V	P0	575V	480V	S1	440V	R2
	240V	288V	U0				575V	S2
	380V	460V	Q0					
	400V	480V	V0					
	415V	500V	R0					
	500V	600V	S0					
Power consumption of coil (50Hz)	Closed (VA)	84		84		115		
	p.f.	0.24		0.24		0.33		
	Closing (VA)	1430		1430		2450		
	p.f.	0.34		0.34		0.21		
Conventional thermal current (A)	300		300		400			
Conventional thermal current of auxiliary contacts (A)	10		10		10			
Rated insulation voltage of auxiliary contacts (V)	690		690		690			
Rated operational current of auxiliary contacts (A)	AC - 15 380/220V	4/6		4/6		4/6		
	DC - 13 110/220V	1.14/0.48		1.14/0.48		1.14/0.48		
Weight (kg)	6.2/6.4		6.2/6.4		8.5/8.7			

3TF AC Contactors









Selection and ordering data															
DC operation															
		3TF30	3TF40	3TF31	3TF41										
Auxiliary contacts NO NC															
			NO - NC		NO - NC		NO - NC								
Order No.		3TF30 00 - 1X 3TF30 10 - 1X 3TF30 01 - 1X	- - 1 - - 1	3TF40 10 - 1X 3TF40 01 - 1X 3TF40 11 - 1X 3TF40 20 - 1X 3TF40 22 - 1X 3TF40 31 - 1X	1 - - 1 1 1 2 - 2 2 3 1	3TF31 00 - 1X 3TF31 10 - 1X 3TF31 01 - 1X	- - 1 - - 1	3TF41 10 - 1X 3TF41 01 - 1X 3TF41 11 - 1X 3TF41 20 - 1X 3TF41 22 - 1X 3TF41 31 - 1X	1 - - 1 1 1 2 - 2 2 3 1						
Rated insulation voltage (V)		690		690		690		690							
Rated operational current (A) (380V)		AC - 3		9		9		12	12						
		AC - 4		3.3		3.3		4.3	4.3						
Rated outputs of three-phase motors at 50Hz (KW)		AC - 3		230/220V 400/380V 500 V 690/660V 1000 V		2.4 4 5.5 5.5 --		2.4 4 5.5 5.5 --		3.3 5.5 7.5 7.5 --	3.3 5.5 7.5 7.5 --				
		AC - 4		400/380V 690/660V		1.48/1.4 2.54/2.4		1.48/1.4 2.54/2.4		2/1.9 3.45/3.3	2/1.9 3.45/3.3				
Mechanical endurance (x10 ⁶)		15		15		15		15	15						
Electrical endurance (x10 ⁶)		AC - 3		1.2		1.2		1.2	1.2						
		AC - 4		0.2		0.2		0.2	0.2						
Switching frequency (1/h)		AC - 3		1000		1000		1000	1000						
		AC - 4		250		250		250	250						
Coil voltage tolerance (AC)		(0.8~1.1)U _s													
Order No. suffixes for rated control voltages for coils		Rated V DC control voltage		12 21.5 24 30 36 42 48 60 110 125 180 220 230 240 250											
3TF3...1X □□ 3TF4...1X □□		Order No. suffix		A4 U4 B4 C4 V4 D4 W4 E4 F4 G4 K4 M4 P4 Q4 N4											
Power consumption of coil (50Hz)		Closing and Closed (W)		6.2		6.2		6.2		6.2		6.2			
Conventional thermal current (A)		20		20		20		20		20		20			
Conventional thermal current of auxiliary contacts (A)		10		10		10		10		10		10			
Rated insulation voltage of auxiliary contacts (V)		690		690		690		690		690		690			
Rated operational current of auxiliary contacts (A)		AC - 15 380/220V		6/10		6/10		6/10		6/10		6/10			
		DC - 13 110/220V		0.9/0.45		0.9/0.45		0.9/0.45		0.9/0.45		0.9/0.45			
Weight (kg)		0.58		0.64		0.58		0.58		0.64		0.64			

Note: 3TX4 auxiliary contact blocks for 3TF3 series, see P2/16.









Selection and ordering data									
DC operation									
		3TF32		3TF42		3TF33		3TF43	
Auxiliary contacts NO NC									
		NO - NC		NO - NC		NO - NC		NO - NC	
Order No.		3TF32 00 - 1X 3TF32 11 - 1X	- - 1 1	3TF42 10 - 1X 3TF42 11 - 1X 3TF42 20 - 1X 3TF42 22 - 1X	1 - 1 1 2 - 2 2	3TF33 00 - 1X 3TF33 11 - 1X	- - 1 1	3TF43 10 - 1X 3TF43 11 - 1X 3TF43 20 - 1X 3TF43 22 - 1X	1 - 1 1 2 - 2 2
Rated insulation voltage (V)		690		690		690		690	
Rated operational current (A) (380V)		AC - 3		16		16		22	
		AC - 4		7.7		7.7		8.5	
Rated outputs of three-phase motors at 50Hz (kW)		230/220V		4		4		5.5	
		400/380V		7.5		7.5		11	
		AC - 3 500 V		9		9		11	
		690/660V		11		11		11	
		1000 V		--		--		--	
		AC - 4 400/380V		3.5		3.5		4	
		690/660V		6		6.6		6.6	
Mechanical endurance (x10 ⁶)		15		15		15		15	
Electrical endurance (x10 ⁶)		AC - 3		1.2		1.2		1.2	
		AC - 4		0.2		0.2		0.2	
Switching frequency (1/h)		AC - 3		750		750		750	
		AC - 4		250		250		250	
Coil voltage tolerance (AC)		(0.8–1.1)U _s							
Order No. suffixes for rated control voltages for coils 3TF3...-1X□□ 3TF4...-1X□□		Rated control voltage		V DC		24		48 110 125 220	
		Order No. suffix		B4		W4		F4 G4 M4	
Power consumption of coil (50Hz)	Closing and Closed (W)	6.2		6.2		6.2		6.2	
Conventional thermal current (A)		30		30		30		30	
Conventional thermal current of auxiliary contacts (A)		10		10		10		10	
Rated insulation voltage of auxiliary contacts (V)		690		690		690		690	
Rated operational current of auxiliary contacts (A)		AC - 15 380/220V		4/6		6/10		4/6	
		DC - 13 110/220V		1.14/0.48		0.9/0.45		1.14/0.48	
Weight (kg)		0.70		0.66		0.70		0.66	

Note: 3TX4 auxiliary contact blocks for 3TF3 series, see P2/16.









3TF AC Contactors

Selection and ordering data											
DC operation											
		3TF34		3TF44		3TF35		3TF45			
Auxiliary contacts NO NC											
		NO - NC		NO - NC		NO - NC		NO - NC			
Order No.		3TF34 00 - 1X 3TF34 11 - 1X		3TF44 11 - 1X 3TF44 22 - 1X		3TF35 00 - 1X 3TF35 11 - 1X		3TF45 11 - 1X 3TF45 22 - 1X			
		- - 1 1		1 1 2 2		- - 1 1		1 1 2 2			
Rated insulation voltage (V)		690		690		690		690			
Rated operational current (A) (380V)		AC - 3		32		32		38			
		AC - 4		15.6		15.6		18.5			
Rated outputs of three-phase motors at 50Hz (kW)		AC - 3 230/220V 400/380V 500 V 690/660V 1000 V		8.5		8.5		11		11	
				15		15		18.5		18.5	
				21		21		25		25	
				23		23		23		23	
		-		-		-		-			
		AC - 4 400/380V 690/660V		7.5		7.5		9		9	
13				13		15.5		15.5			
Mechanical endurance (x10 ⁶)		10		10		10		10			
Electrical endurance (x10 ⁶)		AC - 3		1.2		1.2		1.2			
		AC - 4		0.2		0.2		0.2			
Switching frequency (1/h)		AC - 3		750		750		600			
		AC - 4		250		250		200			
Coil voltage tolerance (AC)		(0.8~1.1)U _s									
Order No. suffixes for rated control voltages for coils 3TF3...1X □□ 3TF4...1X □□		Rated control voltage		V DC		24		48 110 125 220			
		Order No. suffix		B4		W4 F4 G4		M4			
Power consumption of coil (50Hz)		Closing and Closed (W)		11.7		11.7		11.7			
Conventional thermal current (A)		55		55		55		55			
Conventional thermal current of auxiliary contacts (A)		10		10		10		10			
Rated insulation voltage of auxiliary contacts (V)		690		690		690		690			
Rated operational current of auxiliary contacts (A)		AC - 15 380/220V		4/6		4/6		4/6			
		DC - 13 110/220V		1.14/0.48		1.14/0.48		1.14/0.48			
Weight (kg)		1.25		1.43		1.25		1.43			







Note: 3TX4 auxiliary contact blocks for 3TF3 series, see P2/16.

Selection and ordering data															
DC operation															
		3TF46		3TF47		3TF48		3TF49							
Auxiliary contacts NO NC															
		NO - NC		NO - NC		NO - NC		NO - NC							
Order No.		3TF46 22 - 1X 3TF46 33 - 1X	2 2 3 3	3TF47 22 - 1X 3TF47 33 - 1X	2 2 3 3	3TF48 22 - 1X 3TF48 33 - 1X	2 2 3 3	3TF49 22 - 1X 3TF49 33 - 1X	2 2 3 3						
Rated insulation voltage (V)		1000		1000		1000		1000							
Rated operational current (A) (380V)		AC - 3		45		63		75		85					
		AC - 4		24		28		34		42					
Rated outputs of three-phase motors at 50Hz (KW)		230/220V 400/380V		15		18.5		22		26					
		AC - 3 500 V 690/660V 1000 V		22 30 39 7.5		30 41 55 7.5		37 50 67 39		45 59 67 39					
		AC - 4 400/380V 690/660V		12.6/12 21.8/20.8		14.7/14 25.4/24.3		17.9/17 30.9/29.5		22/21 38/36					
Mechanical endurance (x10 ⁶)		3		3		3		3							
Electrical endurance (x10 ⁶)		AC - 3		1.2		1.2		1.2		1.2					
		AC - 4		0.2		0.2		0.2		0.2					
Switching frequency (1/h)		AC - 3		1200		1000		1000		850					
		AC - 4		400		300		300		250					
Coil voltage tolerance (AC)		(0.8–1.1)U _s													
Order No. suffixes for rated control voltages for coils 3TF46...1X□□ 3TF49...1X□□		Rated control voltage		V DC		24		48		110		125		220	
		Order No. suffix		B4		W4		F4		G4		M4			
Power consumption of coil (50Hz)		Closed (W)		2.1		2.1		2.7		2.7					
		Closing (W)		400		400		420		420					
Conventional thermal current (A)		80		90		100		100							
Conventional thermal current of auxiliary contacts (A)		10		10		10		10							
Rated insulation voltage of auxiliary contacts (V)		690		690		690		690							
Rated operational current of auxiliary contacts (A)		AC - 15 380/220V		4/6		4/6		4/6		4/6					
		DC - 13 110/220V		1.14/0.48		1.14/0.48		1.14/0.48		1.14/0.48		1.14/0.48			
Weight (kg)		1.4/1.6		1.4/1.6		2.3/2.5		2.3/2.5							

3TF AC Contactors











Selection and ordering data									
DC operation									
		3TF50		3TF51		3TF52		3TF53	
Auxiliary contacts NO NC									
		NO - NC		NO - NC		NO - NC		NO - NC	
Order No.		3TF50 22 - 1X 3TF50 33 - 1X		3TF51 22 - 1X 3TF51 33 - 1X		3TF52 22 - 1X 3TF52 33 - 1X		3TF53 22 - 1X 3TF53 33 - 1X	
		2 2 3 3		2 2 3 3		2 2 3 3		2 2 3 3	
Rated insulation voltage (V)		1000		1000		1000		1000	
Rated operational current (A) (380V)		AC - 3		110		140		170	
		AC - 4		54		68		75	
Rated outputs of three-phase motors at 50Hz (KW)		230/220V		37		43		55	
		400/380V		55		75		90	
		500 V		76		98		118	
		690/660V		100		100		156	
		1000 V		65		65		90	
		AC - 4		400/380V 690/660V		28.4/27 49/46.9		36/35 63/60	
52/50 90/86									
Mechanical endurance (x10 ⁶)		3		3		3		3	
Electrical endurance (x10 ⁶)		AC - 3		1.2		1.2		1.2	
		AC - 4		0.2		0.2		0.2	
Switching frequency (1/h)		AC - 3		1000		750		700	
		AC - 4		300		200		200	
Coil voltage tolerance (AC)		(0.8~1.1)U _s							
Order No. suffixes for rated control voltages for coils 3TF50...1X□□ 3TF53...1X□□		Rated control voltage		V DC		24		48 110 125 220	
		Order No. suffix		B4		W4 F4 G4		M4	
Power consumption of coil (50Hz)		Closed (W)		2.7		2.7		11	
		Closing (W)		500		500		876	
Conventional thermal current (A)		160		160		210		220	
Conventional thermal current of auxiliary contacts (A)		10		10		10		10	
Rated insulation voltage of auxiliary contacts (V)		690		690		690		690	
Rated operational current of auxiliary contacts (A)		AC - 15 380/220V		4/6		4/6		4/6	
		DC - 13 110/220V		1.14/0.48		1.14/0.48		1.14/0.48	
Weight (kg)		3.3/3.5		3.3/3.5		5.4/5.6		5.4/5.6	





Note: The changeover contactor of 3TF52~3TF56 DC operation contactors is included in the delivery and contained in the contactor package.

Selection and ordering data						
DC operation						
		3TF54	3TF55	3TF56		
Auxiliary contacts NO NC						
		NO - NC	NO - NC	NO - NC		
Order No.		3TF54 22 - 1X 3TF54 33 - 1X	2 2 3 3	3TF55 22 - 1X 3TF55 33 - 1X	2 2 3 3	3TF56 22 - 1X 3TF56 33 - 1X
					2 2 3 3	
Rated insulation voltage (V)		1000	1000	1000		
Rated operational current (A) (380V)	AC - 3	250	300	400		
	AC - 4	110	125	150		
Rated outputs of three-phase motors at 50Hz (KW)	230/220V 400/380V AC - 3 500 V 690/660V 1000 V	78 132 178 235 132	93 160 210 235 132	125 200 284 375 250		
	AC - 4 400/380V 690/660V	61/58 105/100	69/66 119/114	85/81 147/140		
Mechanical endurance (x10 ⁶)		3	3	3		
Electrical endurance (x10 ⁶)	AC - 3	1.2	1.2	1.2		
	AC - 4	0.2	0.2	0.2		
Switching frequency (1/h)	AC - 3	700	500	500		
	AC - 4	200	130	150		
Coil voltage tolerance (AC)		(0.8–1.1)U _s				
Order No. suffixes for rated control voltages for coils 3TF54...1X□□		Rated control voltage V DC				
3TF56...1X□□		24 48 110 125 220				
		Order No. suffix B4 W4 F4 G4 M4				
Power consumption of coil (50Hz)	Closed (W)	13.3	13.3	14		
	Closing(W)	1216	1216	1306		
Conventional thermal current (A)		300	300	400		
Conventional thermal current of auxiliary contacts (A)		10	10	10		
Rated insulation voltage of auxiliary contacts (V)		690	690	690		
Rated operational current of auxiliary contacts (A)	AC - 15 380/220V	4/6	4/6	4/6		
	DC - 13 110/220V	1.14/0.48	1.14/0.48	1.14/0.48		
Weight (kg)		6.8/7.0	6.8/7.0	9.2/9.4		

Note: The changeover contactor of 3TF52~3TF56 DC operation contactors is included in the delivery and contained in the contactor package.

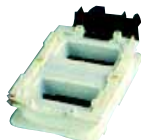
3TB AC Contactors



Selection and ordering data													
AC operation													
		3TB40	3TB41	3TB42	3TB43	3TB44							
Auxiliary contacts NO NC													
		NO - NC	NO - NC	NO - NC	NO - NC	NO - NC							
Order No.		3TB40 10 - 0X 3TB40 01 - 0X 3TB40 22 - 0X	1 - - 1 2 2	3TB41 10 - 0X 3TB41 01 - 0X 3TB41 22 - 0X	1 - - 1 2 2	3TB42 22 - 0X	2 2	3TB43 22 - 0X	2 2	3TB44 22 - 0X	2 2		
Rated insulation voltage (V)		660		660		660		660		660			
Rated operational current (A) (380V)		AC - 3		12		16		22		32			
		AC - 4		4.3		7.7		8.5		15.6			
Rated outputs of three-phase motors at 50Hz (kW)		AC - 3		7.5		10		11		21			
		230/220V		2.4		3.3		4		6.1		8.5	
		400/380V		4		5.5		7.5		11		15	
		500 V		5.5		7.5		11		11		21	
		690/660V		5.5		7.5		11		11		23	
		1000 V		--		--		--		--		--	
AC - 4		400/380V		1.4		1.9		3.5		7.5			
		690/660V		2.4		3.3		6		13			
Mechanical endurance (x10 ⁶)		10		10		10		10		10			
Electrical endurance (x10 ⁶)		AC - 3		1.0		1.0		1.0		1.0			
		AC - 4		0.2		0.2		0.2		0.2			
Switching frequency (1/h)		AC - 3		1000		1000		750		750			
		AC - 4		250		250		250		250			
Coil voltage tolerance (AC)		(0.8~1.1)U _s											
Order No. suffixes for rated control voltages for coils 3TB40..-0X□□ 3TB44..-0X□□		Coils for 50Hz V AC					Coils for 50/60Hz V AC						
		24		B0			24		C2				
		42		D0			42		D2				
		110		F0			110		G2				
		220		M0			220		N2				
		240		U0			240		P2				
380		Q0											
Power consumption of coil (50Hz)		Closed (VA)		10		10		10		10			
		p.f.		0.29		0.29		0.29		0.29			
		Closing (VA)		68		68		68		68			
		p.f.		0.82		0.82		0.82		0.82			
Conventional thermal current (A)		20		20		30		30		45			
Conventional thermal current of auxiliary contacts (A)		10		10		10		10		10			
Rated insulation voltage of auxiliary contacts (V)		660		660		660		660		660			
Rated operational current of auxiliary contacts (A)		AC - 15 380/220V		6/10		6/10		6/10		4/6			
		DC - 13 110/220V		0.9/0.45		0.9/0.45		0.9/0.45		0.9/0.45			
Weight (kg)		0.43		0.43		0.49		0.49		0.7			

Spare Parts						
Type	Contactor size	Contacts No		Order No	Illustration	Weight
		NO	NC			kg
 3TY75 61-1. Auxiliary contacts block	3TF32 11, 3TF33 11	1	1	3TX4 011 - 8A	Auxiliary contacts left	0.042
	3TF34 11, 3TF35 11	1	1	3TY7 561 - 1AA00	Auxiliary contacts left	
	3TF44 - 3TF56	1	1	3TY7 561 - 1AA00	Auxiliary contacts left	
		1	1	3TY7 561 - 1AA00	Auxiliary contacts right	
	3TF46 - 3TF56	1	1	3TY7 561 - 1KA00	2nd auxiliary contacts left	
		1	1	3TY7 561 - 1KA00	2nd auxiliary contacts right	
 3BE; Coil	3TF30 - 3TF33 3TF40 - 3TF43 3TH3 - 3TH4			3TY7 403 - 0X..	Double coil from 3TF48	0.07
	3TF34 - 3TF35 3TF44 - 3TF45			3TY7 443 - 0X..		0.1
	3TF46, 3TF47			3TY7 463 - 0X..		0.12
	3TF48, 3TF49 3TF50, 3TF51 3TF52, 3TF53 3TF54, 3TF55 3TF56			3TY7 483 - 0X.. 3TY7 503 - 0X.. 3TY7 523 - 0X.. 3TY7 543 - 0X.. 3TY7 563 - 0X..		0.2 0.23 0.35 0.39 0.56
 3TX40.. - ..	3TF30 - 3TF35 3TH3					
 3TY7.0 - 0X Contact bridge Contacts	3TF44 3TF45			3TY74 40 - 0X 3TY74 50 - 0X	Three pieces of contact bridge and six pieces of contacts consists of one sets	0.1
	3TF46 3TF47			3TY74 60 - 0X 3TY74 70 - 0X		0.1
	3TF48 3TF49			3TY74 80 - 0X 3TY74 90 - 0X		0.13
	3TF50 3TF51			3TY75 00 - 0X 3TY75 10 - 0X		0.25
	3TF52 3TF53			3TY75 20 - 0X 3TY75 30 - 0X		0.3
	3TF54 3TF55			3TY75 40 - 0X 3TY75 50 - 0X		0.47
	3TF56			3TY75 60 - 0X		0.73
 3TY7.2 - 0X Arcing chamber	3TF44 3TF45			3TY74 42 - 0X 3TY74 52 - 0X	Arcing chamber	0.15
	3TF46 3TF47			3TY74 62 - 0X 3TY74 72 - 0X		0.28
	3TF48 3TF49			3TY74 82 - 0X 3TY74 92 - 0X		0.45
	3TF50 3TF51			3TY75 01 - 0X 3TY75 12 - 0X		0.75
	3TF52 3TF53			3TY75 22 - 0X 3TY75 32 - 0X		1
	3TF54 3TF55			3TY75 42 - 0X 3TY75 52 - 0X		1.3
	3TF56			3TY75 62 - 0X		1.7

Auxiliary contact blocks

When an additional auxiliary contact is needed, you can select the 3TX4 auxiliary contact block for the 3TF3 contactors only. Up to 4 auxiliary contact blocks with 1NO or 1NC contact can be plugged onto 3TF3 contactors.

Mounting see 3TH30 mounting size figure

 <p>3TX4</p>	Rated operational current $I_e/AC - 15/AC - 14$				Contacts		Order No.	Weight
	230/ 220V A	400/ 380V A	500V A	690/ 660V A	 NO	 NC		kg
	5.6/6	3.8/4	2.5	1.8/2	1	-	3TX4 010 - 2A 3TX4 001 - 2A 3TX4 010 - 3A*	0.02

* 3TX4010 - 3A with switch position indicator

Technical data

Contact endurance of the main contacts (AC-3):

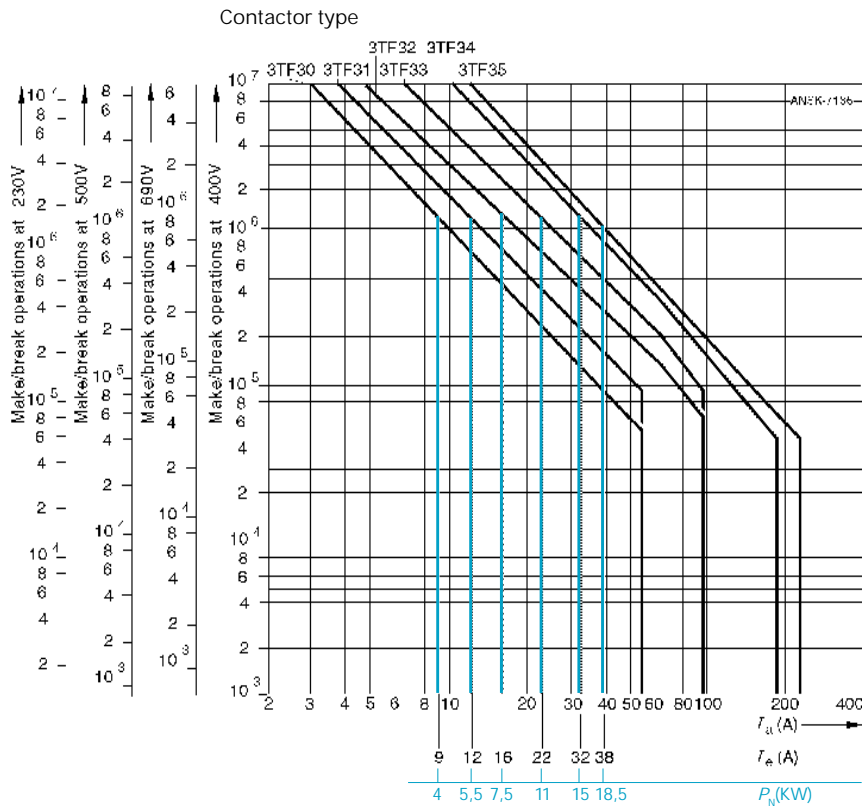

Technical data

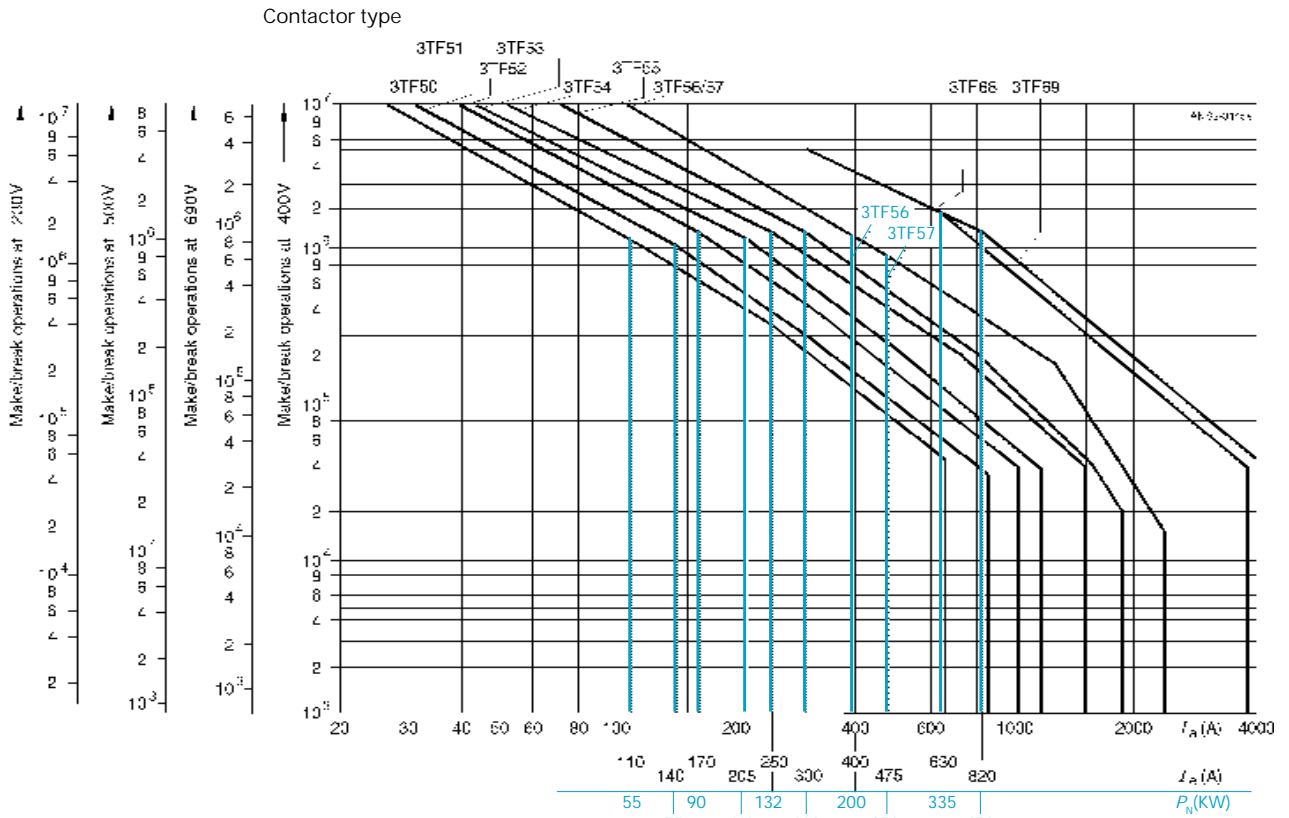
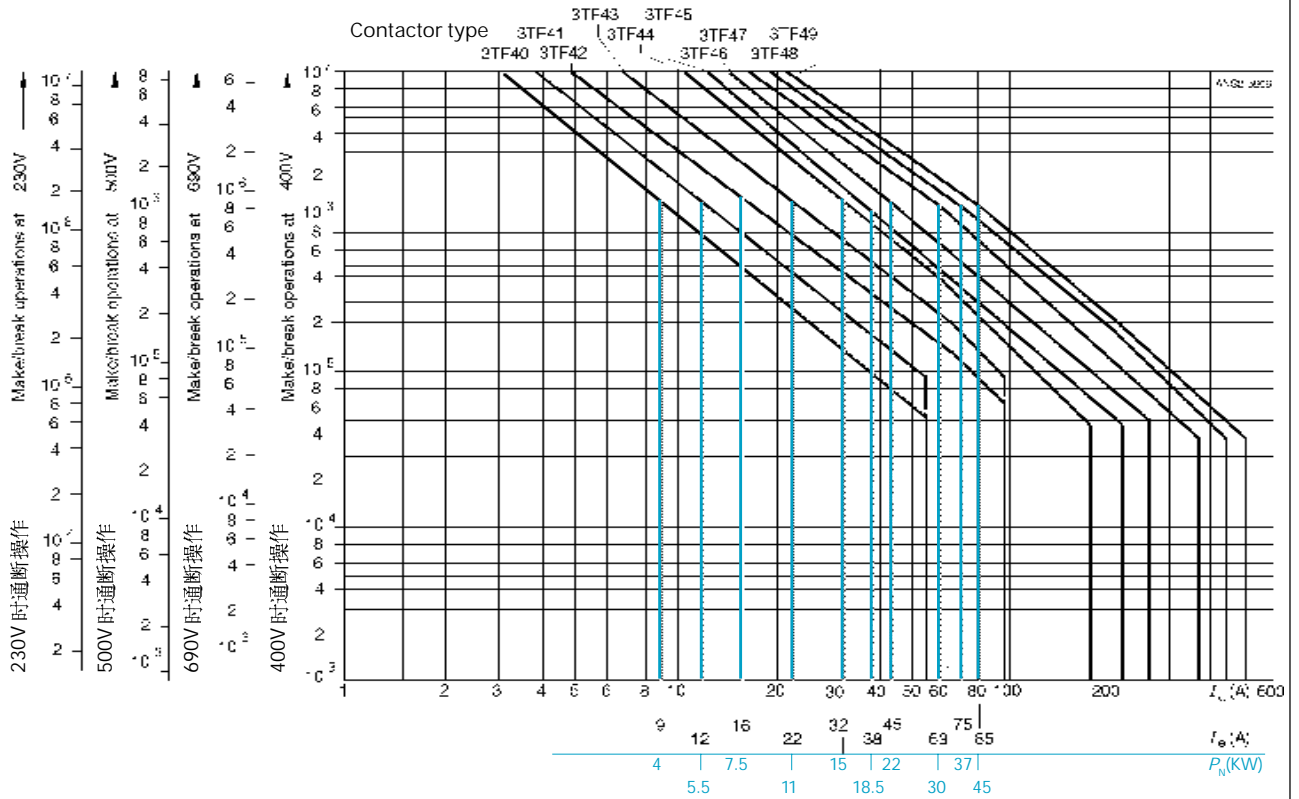

I_b : Breaking current
 I_e : Rated operational current

P_N : Rated output of three-phase motors with squirrel-cage (at 400V)

3TF/3TB AC Contactors

DC circuit diagrams

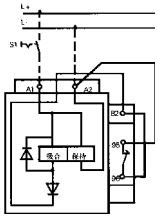

3TF46-3TF51
DC economy circuit

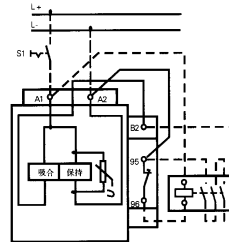

3TF52-3TF56
DC economy circuit
with changeover contactor:
3TF52 ~ 3TF55 : 3TF40
3TF56 : 3TF42

Technical data

Contact endurance of the main contacts (AC-3):

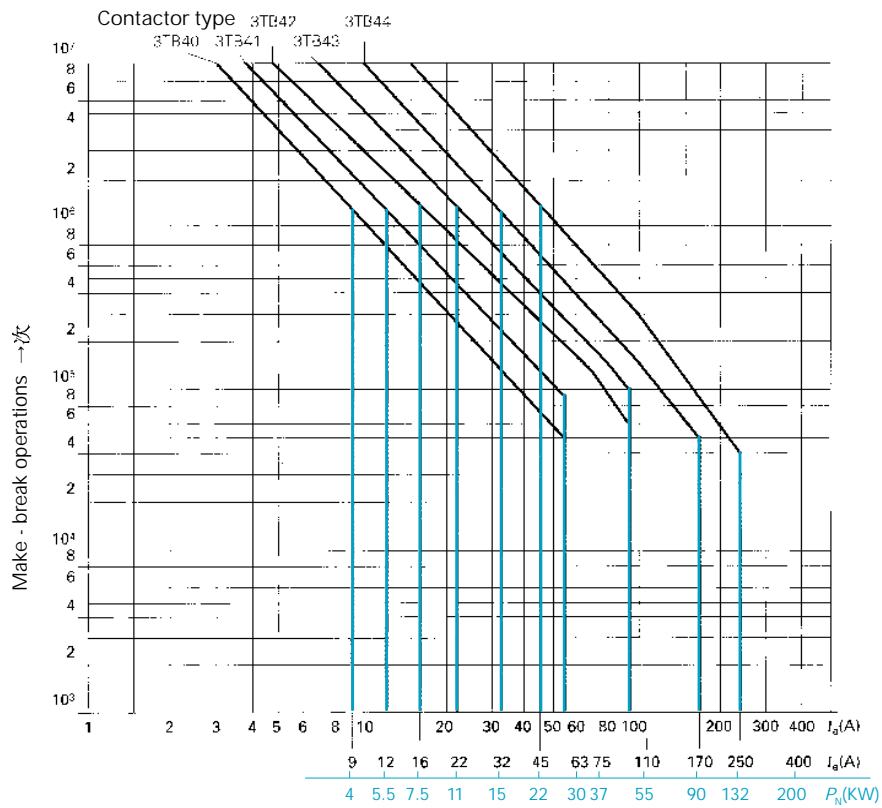

Dimension drawings

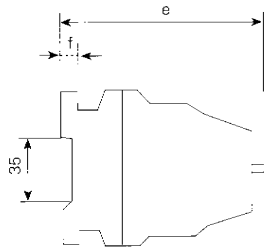
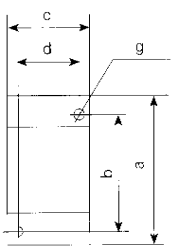

Type	a	b	c	d	e	f	g
3TB40, 3TB41	79	60	46	35	*90 106	7.5	∅5
3TB42, 3TB43	89	75	46	35	116	8	∅5
3TB44	90	75	74	50	109	8	∅5

* Size 90 is suitable for 3TB4010, 3TB4001, 3TB4110, 3TB4101
Size 106 is suitable for 3TB4011, 3TB4022, 3TB4111, 3TB4122

Permissible Mounting Position

The contactors are designed for operation on vertical mounting surface.

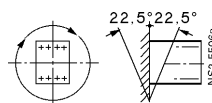

3TB40-3TB43

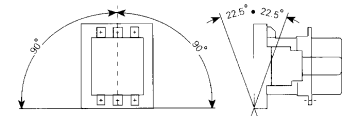

3TB44

Dimension drawings

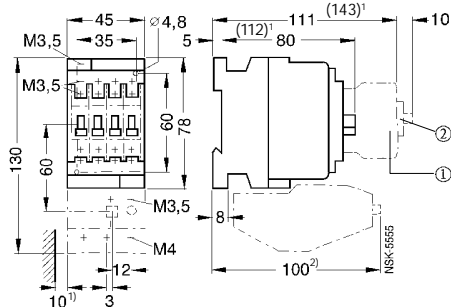

3TF30 and 3TF31, size 0

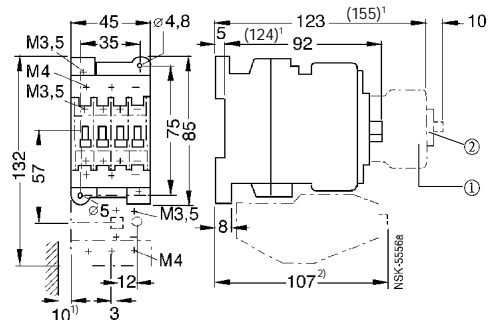

3TF32 and 3TF33, size 1

- ① Auxiliary contact block with position indicator
- ② Labelling plate

Without and with overload relay (3UA52 or 3UW13)

Without and with overload relay (3UA50 or 3UW10)

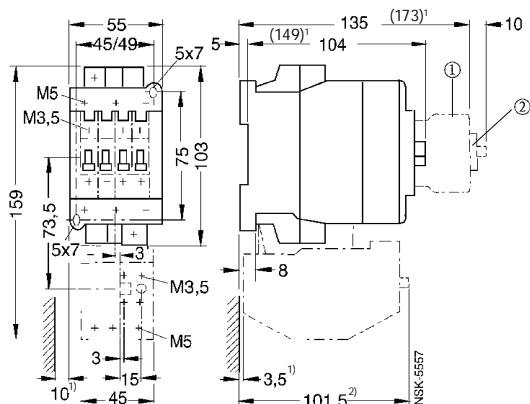

3TF34 and 3TF35, size 2

Without and with overload relay (3UA55)

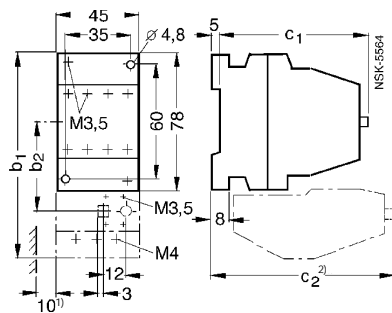

3TF40 and 3TF41, size 0

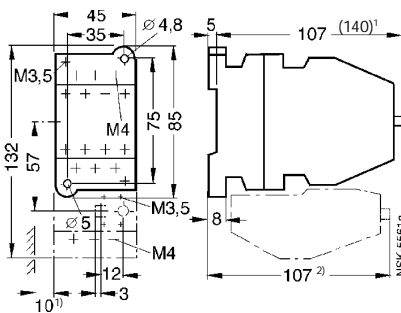

3TF42 and 3TF43, size 1

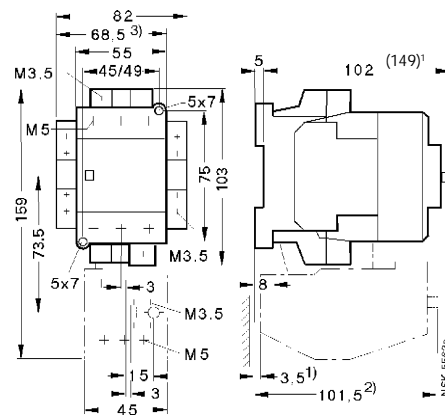

3TF44 and 3TF45, size 2

With and without 3UA50 or 3UW10 overload relay

With and without 3UA52 or 3UW13 overload relay

With and without 3UA55 overload relay

Contacteur Type	b ₁	b ₂	c ₁	(c ₁) ³	c ₂
1NO or 1NC	125	55	81	(115) ³	108
1NO+1NC or	130	60	97	(130) ³	100
2NO+2NC					

(³) DC operation

- ¹) Minimum clearance from the earthed parts
- ²) Dimension for the square OFF - button (stroke 3mm)
Dimension for the round RESET - button (stroke 2.5mm) less 2.5mm

Dimension drawings

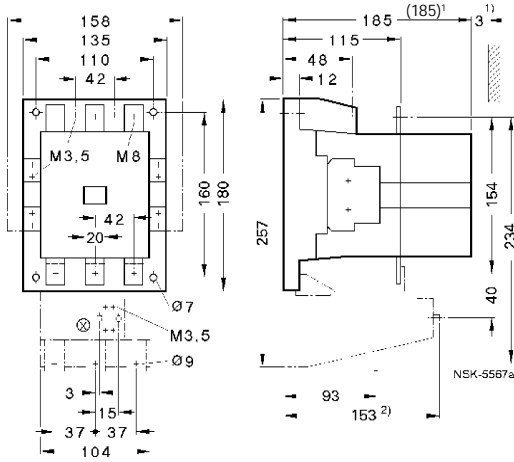

3TF52, size 8

Without and with 3UA62 overload relay

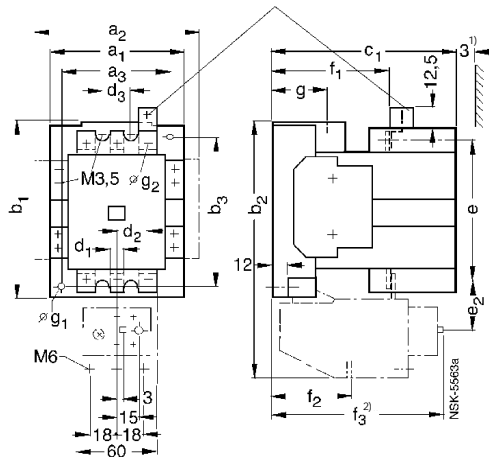

3TF46 to 3TF49, size 3 and 4

With and without 3UA58 overload relay

Size	Type	a ₁	a ₂	a ₃	b ₁	b ₂	b ₃	c ₁	(c ₁) ¹	d ₁	d ₂	d ₃	e	e ₂	f ₁	f ₂	f ₃	g	Øg ₁	Øg ₂
3	3TF46, 3TF47	90	113	70	117	175	100	123	123	8	26.5	25	94	34	80	63	122	28	4.8	6.1(M6)
4	3TF48	100	123	80	133	194	110	140	140	8	26.5	25	107	36	89	63	122	39	5.5	6.1(M6)
4	3TF49	100	123	80	133	194	110	140	140	10.5	26.5	25	116	31.5	89	63	122	39	5.5	6.1(M6)

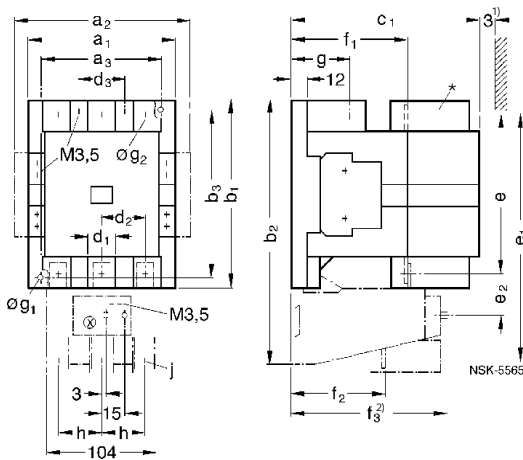

3TF50 and 3TF51, size 6 (box terminal with 3TF50)

With and without overload relay
 3UA60 (with box terminals) for 3TF50
 3UA61 (with box terminals) for 3TF51

Type	h	j
3UA60	37	M6
3UA61	42	M8

* 3TF51 hasn't box terminals, Accessories

Type	a ₁	a ₂	a ₃	b ₁	b ₂	b ₃	c ₁	(c ₁) ¹	d ₁	d ₂	d ₃	e	e ₁	e ₂	f ₁	f ₂	f ₃	g	Øg ₁	Øg ₂
3TF50	120	143	100	150	232	130	150	150	15	37	37	130	213	40	93	80	146	45	6.3	6.1(M6)
3TF51	120	143	100	150	232	130	150	150	20	42	37	139	215.5	40.5	93	80	146	45	6.3	9(M8)

()¹ DC operation

Dimension drawings

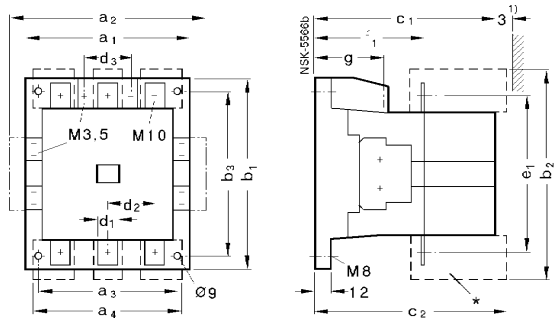

3TF53 to 3TF56, size 8~12

Type	a ₁	a ₂	a ₃	b ₁	b ₃	c ₁	(c ₁) ¹	e ₁	f ₁	g	d ₁	d ₂	∅g ₁
3TF53	135	158	110	180	160	185	185	159	115	48	25	48	7
3TF54, 3TF55	145	168	120	200	180	198	198	168	132	58	25	48	9
3TF53	160	183	130	200	180	222	222	178	150	65	25	48	9

* With box terminals (Accessories)

()¹ DC operation

Permissible mounting position

The contactors are designed for operation on vertical mounting surface.

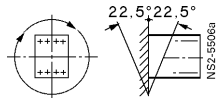

3TF30 - 3TF33 (AC operation)
3TF40 - 3TF43 (AC operation)

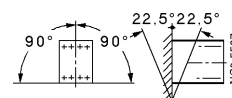

3TF34 - 3TF35 (AC operation)
3TF44 - 3TF56 (AC operation)
3TF30 - 3TF33 (DC operation)
3TF40 - 3TF43 (DC solenoid system)
3TF46 - 3TF56 (DC economy circuit)

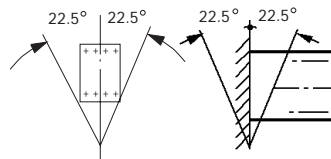

3TF34, 3TF35 (DC operation)
3TF44, 3TF45 (DC solenoid system)

3TD Reversing Contactor Combinations

Description

3TD Reversing Contactor Combinations are suitable for frequency of 50/60Hz, rated insulation voltage up to 690 – 1000V, rated operational current 9A – 400A at rated operational voltage 380V under AC - 3. They are mainly used for controlling the forward and reverse rotation. They comply with IEC947, VDE0660, GB14048.

Operating Conditions

- The altitude of the site of installation does not exceed 2000 meters above sea levels.
- The ambient air temperature: -25 ~ +55°C
- Relative humidity does not exceed 50% at +40°C and 90% at +25°C
- Atmospheric conditions: the air does not contain any explosive medium, corrosive gases and conductive dust.
- Never be shocked and vibrated obviously.
- Never be wetted by rain and snow.

Features

- It is a Combinations consisting of two same type sets of 3TF AC contactors, between which one is interlocked by another through a mechanical device.
- The mechanical interlocking device does not affect the acting time of a single set of AC contactors.
- The conducting wires of the main circuit and auxiliary circuit have been connected. (The products without connection can also be supplied.)
- Compact in size, reliable in interlocking.
- The overload relays 3UA can be mounting directly on the 3TD (up to 3TD42).

Type model nomenclature

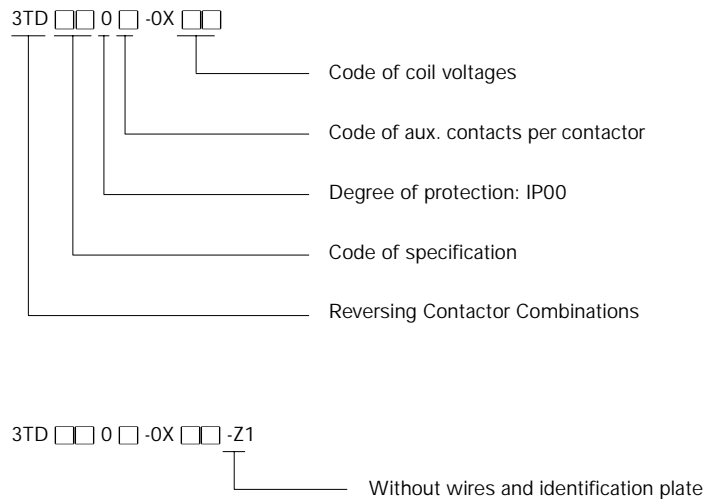

Selection and ordering data

- Mechanical endurance: 10 x10⁶ operations;
- Operating time: the making time of the contacts in a contactor can not overlap the arcing time of the contacts in another contactor;
- The other technical data are same as those of 3TF, for example 3TD40, see 3TF40;
- Parameters and order specifications.

	Order No.	Auxi. contact no. per contactor		Rated operational current I_e at AC-3, 400/380V A	Rated outputs of three-phase motors AC-3					Overload Relay Type	Fuses Conduction type				
		NO	NC		230/220V	400/380V	500V	690/660V	1000V		"1" A	"2" A			
					KW	KW	KW	KW	KW						
	3TD40 02 - 0X ..	2	2	9	2.4	4	5.5	5.5	-	3UA50	35	25			
	3TD40 02 - 0X .. - Z1	2	2												
	3TD40 01 - 0X .. - Z1	1	1												
	3TD40 00 - 0X .. - Z1	-	1												
	3TD41 02 - 0X ..	2	2	12	3.3	5.5	7.5	7.5	-		3UA50	35	25		
	3TD41 02 - 0X .. - Z1	2	2												
	3TD41 01 - 0X .. - Z1	1	1												
	3TD41 00 - 0X .. - Z1	-	1												
	3TD42 02 - 0X ..	2	2	16	4	7.5	9	11	-			3UA52	65	35	
	3TD42 02 - 0X .. - Z1	2	2												
	3TD43 02 - 0X ..	2	2	22	5.5	11	11	11	-				3UA52	65	35
	3TD43 02 - 0X .. - Z1	2	2												
	3TD44 02 - 0X ..	2	2	32	8.5	15	21	23	-	3UA55		80		63	
	3TD44 02 - 0X .. - Z1	2	2												
	3TD45 02 - 0X ..	2	2	38	11	18.5	25	23	-			3UA55	80	63	
	3TD45 02 - 0X .. - Z1	2	2												
	3TD46 02 - 0X ..	2	2	45	15	22	30	39	-	3UA58	160		100		
	3TD47 02 - 0X ..	2	2	63	18.5	30	41	55	-		160		125		
	3TD48 02 - 0X ..	2	2	75	22	37	50	67	39		250	160			
	3TD50 02 - 0X ..	2	2	110	37	55	76	100	55	3UA60	315	250			
	3TD52 02 - 0X ..	2	2	170	55	90	118	156	90	3AU62	355	250			
	3TD54 02 - 0X ..	2	2	250	78	132	178	235	132	3UA66	500	315			
	3TD56 02 - 0X ..	2	2										400	125	200

1) The coil for AC 50/60 Hz for 3TD40 to 3TD50 contactor combinations should be used only if it is ensured that between the signal output for both directions of rotation minimum dead interval on reversing of 50ms exists.

2) Selection of the fuses in the above table is in accordance with excerpt from IEC947 - 4.

Type of co-ordination "1":

Destruction of contactor and overload relay is admissible. Contactor and/or overload relay must be replaced, if necessary.

Type of co-ordination "2":

No damage can be tolerated on the overload relay, but contact welding on the contactor is permitted, if the contacts can easily be separated.

3TD Reversing Contactor Combinations

Conductor cross-section (screw terminal)

- | | |
|---|--|
| <p>1. Main conductors</p> <p>a) solid/stranded</p> <p>b) finely stranded with and without end sleeve</p> <p>c) finely stranded with cable lug</p> <p>d) stranded with cable lug</p> <p>e) connecting bars</p> <p>f) stripped length</p> <p>g) terminal screws</p> <p>h) tightening torque</p> <p>i) AWG wires</p> | <p>2. Auxiliary conductors</p> <p>a) solid</p> <p>b) finely stranded with end sleeve</p> <p>c) terminal screws</p> <p>d) tightening torque</p> <p>e) AWG wires</p> |
|---|--|

	1.a) mm ²	1.b) mm ²	1.c) mm ²	1.d) mm ²	1.e) mm ²	1.f) mm	1.g)	1.h) Nm/lb.in	1.i) AWG	2.a) mm ²	2.b) mm ²	2.c)	2.d) Nm/lbin	2.e) AWG
3TD40 3TD41	1~2.5 1 × 4	0.75-2.5	-	-	-	10	M3.5	0.8~1, 4/7~12	18~12	0.5~2.5	0.75~2.5	M3.5	0.8~1, 4/7~12	18~14
3TD42 3TD43	2.5~6	1.5~4	-	-	-	12	M4	1~1.5/9~13	14~10	0.5~2.5	0.75~2.5	M3.5	0.8~1, 4/7~12	18~14
3TD44 3TD45	2.5~25	2.5~16	-	-	-	10	M5	2.5~3/22~26.5	14~6					
3TD46 3TD47 3TD48	6~35	4~25	-	-	-	16 ⁺³	-	3~4						
3TD50	25~70	25~50	-	-	-	22 ⁺³	-	4~5						
3TD52	-	-	35~95	50~120	20 × 3	-	M8	10~14						
3TD54	-	-	50~240	70~240	25 × 5	-	M10	14~16.5						
3TD56	-	-	50~240	70~240	2 × (25 × 5)	-	M10	14~16.5						

Circuit diagrams

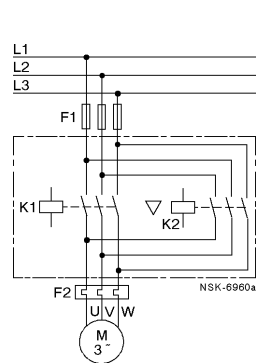

Power circuit

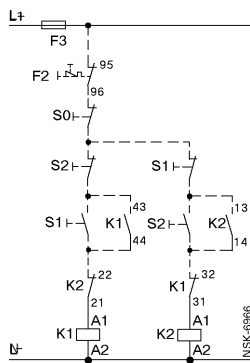

Control circuit for momentary-contact control

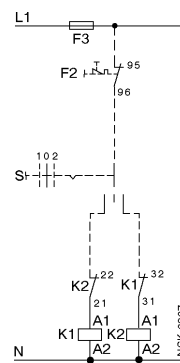

Control circuit for maintained-contact control

- | | |
|--|--|
| S0 "Off" button | K1 Contactor for clockwise rotation |
| S1 "On-clockwise" button | K2 Contactor for anti-clockwise rotation |
| S2 "On-anti-clockwise" button | F1 Fuse for power circuit |
| S "clockwise-Off-anti-clockwise" selector switch | F2 Overload relay |
| | F3 Fuse for control circuit |

Permissible mounting position

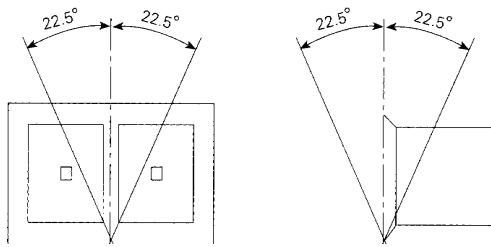

Dimension drawings

1. 3TD40, 3TD41 c=97mm/81mm

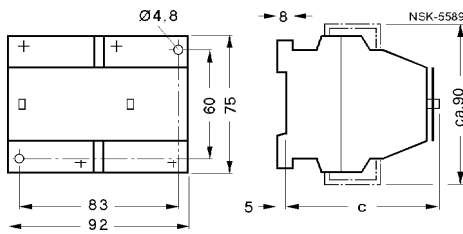

2. 3TD42, 3TD43 c=107mm

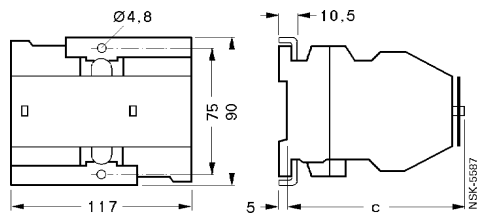

3. 3TD44, 3TD45 c=102mm

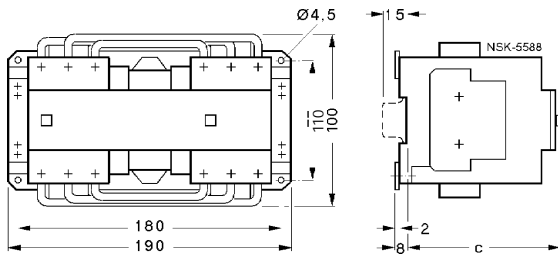

4. 3TD46 - 3TD48

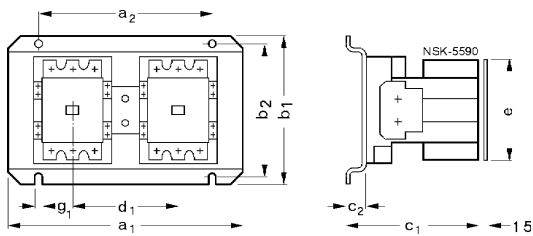

5. 3TD50 - 3TD56

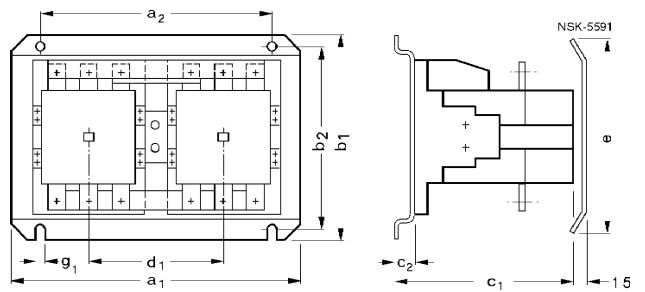

	a1	a2	b1	b2	b4	c1	c2	d1	e	g1
3TD46	240	180	165	145	-	141	18	117	150	7(M6)
3TD47	240	180	165	145	-	141	18	117	150	7(M6)
3TD48	260	200	175	155	-	158	18	127	160	7(M6)
3TD50	300	240	210	185	260	168	18	147	-	9(M8)
3TD52	330	270	240	215	315	203	18	162	-	9(M8)
3TD54	350	290	265	240	375	219	21	172	-	11(M10)
3TD56	380	310	265	240	385	243	21	187	-	11(M10)