

CMOS DECADE 7-SEGMENT DECODERS

FEATURES

- ◆ Decade Counter and 7-Segment Decoder in One Package
- ◆ Easily Interfaced with 7-Segment Display Types
- ◆ Direct Reset
- ◆ Display Enable Function (4026AB)
- ◆ Ripple Blanking and Lamp Test Functions (4033AB)
- ◆ Trigger from either Edge of Clock Input
- ◆ Carry Output for Cascading Stages
- ◆ Fully Static Operation - DC to 5MHz @ 10Vdc

DESCRIPTION

These two devices each consist of a 5-stage Johnson Decade Counter and an Output Decoder which converts the Johnson code to a 7-segment decoded output for driving each stage in a numerical display. A high Reset signal clears the decade counter to its zero count. The counters have interchangeable Clock and Clock Enable lines for incrementing on either a positive-going or negative-going transition, respectively. Antilock gating is provided on the Johnson counter, thus assuring proper counting sequence. The Carry-Out (C_{OUT}) signal completes one cycle every ten clock input cycles and is used to directly clock the succeeding decade in a multi-decade counting chain.

4026AB

When the Display Enable is low, the seven decoded outputs are forced off regardless of the state of the counter. Activation of the display only when required results in significant power savings. This system also facilitates implementation of display-character multiplexing.

The Carry Out and ungated "C-segment" signals are not gated by the Display Enable and therefore are available continuously. This feature is a requirement in implementation of certain divider functions such as divide-by-60 and divide-by-12.

4033AB

The 4033AB has provisions for automatic blanking of the non-significant zeros in a multi-digit decimal number which results in an easily readable display consistent with normal writing practice. For example, the number 0050.0700 in an eight digit display would be displayed as 50.07. Zero suppression on the integer side is obtained by connecting the RBI terminal of the 4033AB associated with the most significant digit in the display to a "low-level" voltage and connecting the RBO terminal of that stage to the RBI terminal of the 4033AB in the next-lower-significant position in the display. This procedure is continued for each succeeding 4033AB on the integer side of the display. On the fraction side of the display the

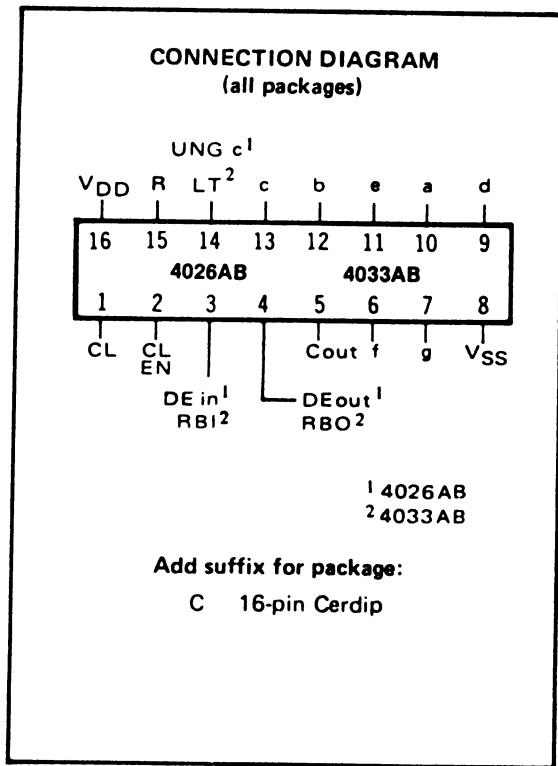

RECOMMENDED OPERATING CONDITIONS

For maximum reliability:

DC Supply Voltage	$V_{DD} - V_{SS}$	3 to 15	Vdc
Operating Temperature	T_A	-55 to +125	°C

RBI of the 4033AB associated with the least significant digit is connected to a "low-level" voltage and the RBO of the 4033AB is connected to the RBI terminal of the 4033AB in the next-more-significant-digit position. Again, this procedure is continued for each 4033AB on the fraction side of the display.

In a purely fractional number the zero immediately preceding the decimal point can be displayed by connecting the RBI of that stage to a high voltage (instead of to the RBO of the next-more-significant stage). For Example: optional zero - 0.7346.

Likewise, the zero in a number such as 763.0 can be displayed by connecting the RBI of the 4033AB associated with it to a "high-level" voltage.

A "high" Lamp Test signal turns on all outputs.

ELECTRICAL CHARACTERISTICS

STATIC CHARACTERISTICS¹

PARAMETER	V _{DD} (Vdc)	CONDITIONS	T _{LOW} ²		+25°C			T _{HIGH} ³		Units		
			Min.	Max.	Min.	Typ.	Max.	Min.	Max.			
QUIESCENT DEVICE CURRENT	I _{DD}	5	V _{IN} =V _{SS} or V _{DD}	-	5	-	0.05	5	-	150	μA _{dc}	
		10	All valid input combinations	-	10	-	0.1	10	-	300		
		15		-	20	-	0.2	20	-	600		
OUTPUT HIGH (SOURCE) CURRENT	I _{OH}	Decoded outputs	5	V _{OH} =4.6V	-0.175	-	-0.14	-0.28	-	-0.10	-	mA _{dc}
			10	V _{OH} =9.5V	-0.375	-	-0.3	-0.6	-	-0.21	-	
			15	V _{OH} =13.5V V _{IN} =V _{SS} or V _{DD}	-1.25	-	-1.0	-2.5	-	-0.7	-	
		Carry output	5	V _{OH} =4.6V	-0.19	-	-0.15	-0.4	-	-0.11	-	mA _{dc}
			10	V _{OH} =9.5V	-0.43	-	-0.35	-1.0	-	-0.25	-	
			15	V _{OH} =13.5V V _{IN} =V _{SS} or V _{DD}	-1.57	-	-1.25	-4.0	-	-0.88	-	
		Remaining Outputs	5	V _{OH} =4.6V	-0.10	-	-0.08	-0.2	-	-0.056	-	mA _{dc}
			10	V _{OH} =9.5V	-0.25	-	-0.20	-0.5	-	-0.14	-	
			15	V _{OH} =13.5V V _{IN} =V _{SS} or V _{DD}	-0.75	-	-0.60	-1.5	-	-0.42	-	
OUTPUT LOW (SINK) CURRENT	I _{OL}	All Outputs Except Carry	5	V _{OL} =0.4V	0.125	-	0.1	0.3	-	0.07	-	mA _{dc}
			10	V _{OL} =0.5V	0.31	-	0.25	0.6	-	0.175	-	
			15	V _{OL} =1.5V V _{IN} =V _{SS} or V _{DD}	1.44	-	1.15	2.5	-	0.81	-	
		Carry output	5	V _{OL} =0.4V	0.19	-	0.15	0.4	-	0.11	-	mA _{dc}
			10	V _{OL} =0.5V	0.45	-	0.35	1.0	-	0.25	-	
			15	V _{OL} =1.5V V _{IN} =V _{SS} or V _{DD}	1.57	-	1.25	4.0	-	0.88	-	

NOTES: ¹ Remaining Static Electrical Characteristics are listed under "4000B Series Family Specifications".

² T_{LOW} = -55°C for C

T_{HIGH} = +125°C for C

DYNAMIC CHARACTERISTICS (C_L = 50pF, T_A = 25°C)

PARAMETER	V _{DD} (Vdc)	Min.	Typ.	Max.	Units		
CLOCKED OPERATION							
PROPAGATION DELAY TIME Clock to Decoded Outputs	t _{PLH} , t _{PHL}	5	-	500	1000	ns	
		10	-	225	450		
		15	-	175	350		
Clock to Carry Out	t _{PLH} , t _{PHL}	5	-	450	900	ns	
		10	-	125	250		
		15	-	100	200		
OUTPUT TRANSITION TIME	Decoded Outputs	t _{TLH} , t _{THL}	5	-	250	500	ns
			10	-	125	250	
			15	-	100	200	
	Carry Output	t _{TLH} , t _{THL}	5	-	200	400	ns
			10	-	100	200	
			15	-	80	160	
MINIMUM CLOCK OR ENABLE PULSE WIDTH	PW _{CL} , PW _{CE}	5	-	200	400	ns	
		10	-	100	200		
		15	-	80	160		
MAXIMUM CLOCK FREQUENCY	f _{CL}	5	1.25	2.5	-	MHz	
		10	2.5	5.0	-		
		15	3.0	6.0	-		
MAXIMUM CLOCK OR ENABLE RISE AND FALL TIME	t _{rCL} , t _{fCL}	5	15	-	-	μs	
		10	15	-	-		
		15	3	-	-		
MINIMUM CLOCK OR ENABLE SETUP TIME	t _{setup}	5	-	250	500	ns	
		10	-	100	200		
		15	-	80	160		
RESET OPERATION							
PROPAGATION DELAY TIME Reset to Decoded Outputs	t _{PLH} , t _{PHL}	5	-	700	1400	ns	
		10	-	250	500		
		15	-	200	400		
Reset to Carry Output	t _{PLH} , t _{PHL}	5	-	500	1000	ns	
		10	-	125	250		
		15	-	100	200		
MINIMUM RESET PULSE WIDTH	PW _R	5	-	200	400	ns	
		10	-	100	200		
		15	-	80	160		
RESET REMOVAL TIME	t _{rem}	5	-	375	750	ns	
		10	-	150	300		
		15	-	125	250		

DISPLAY INTERFACE

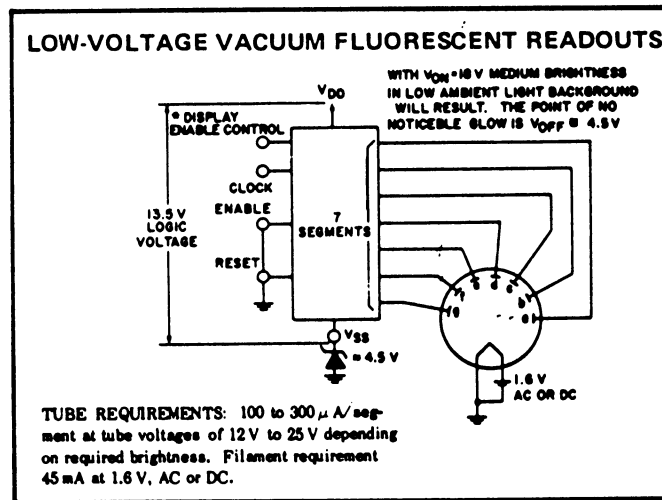
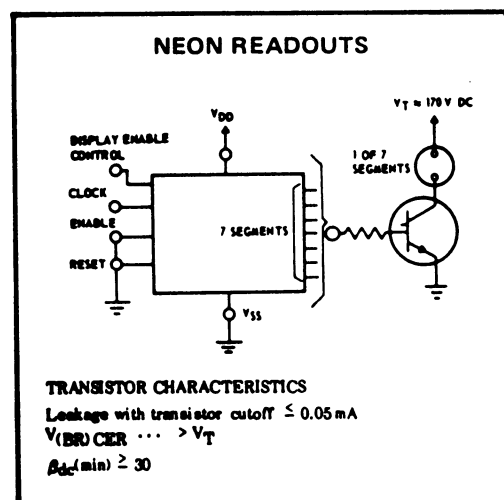
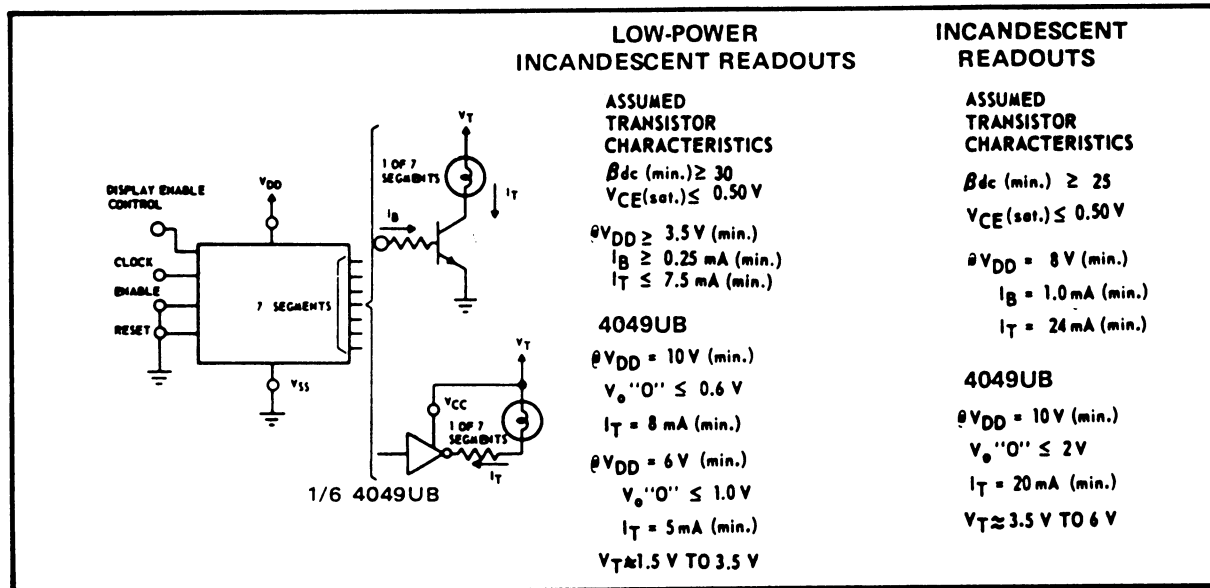
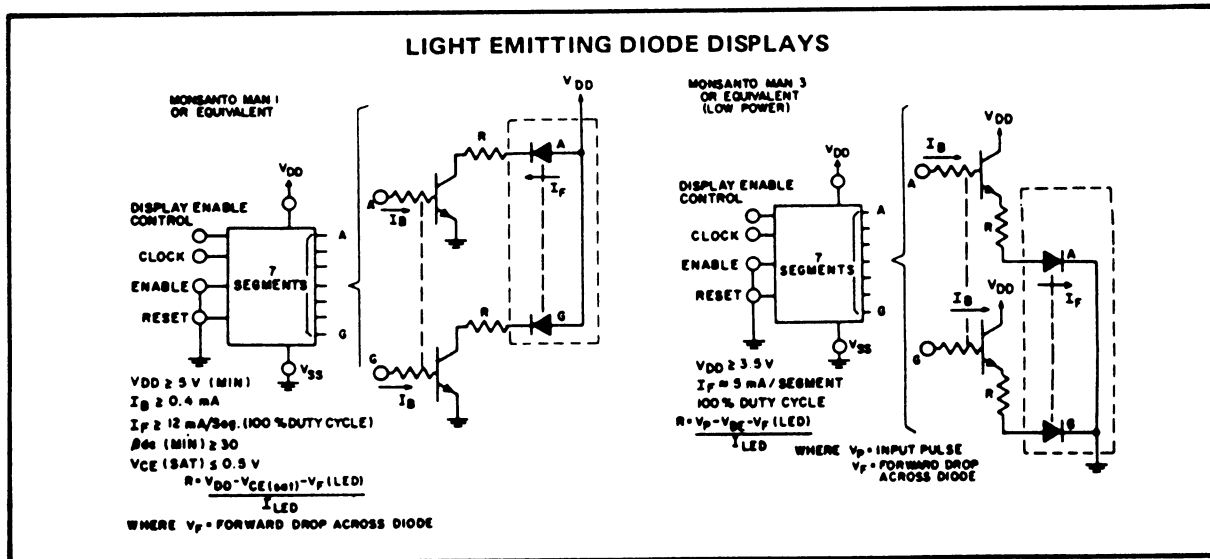

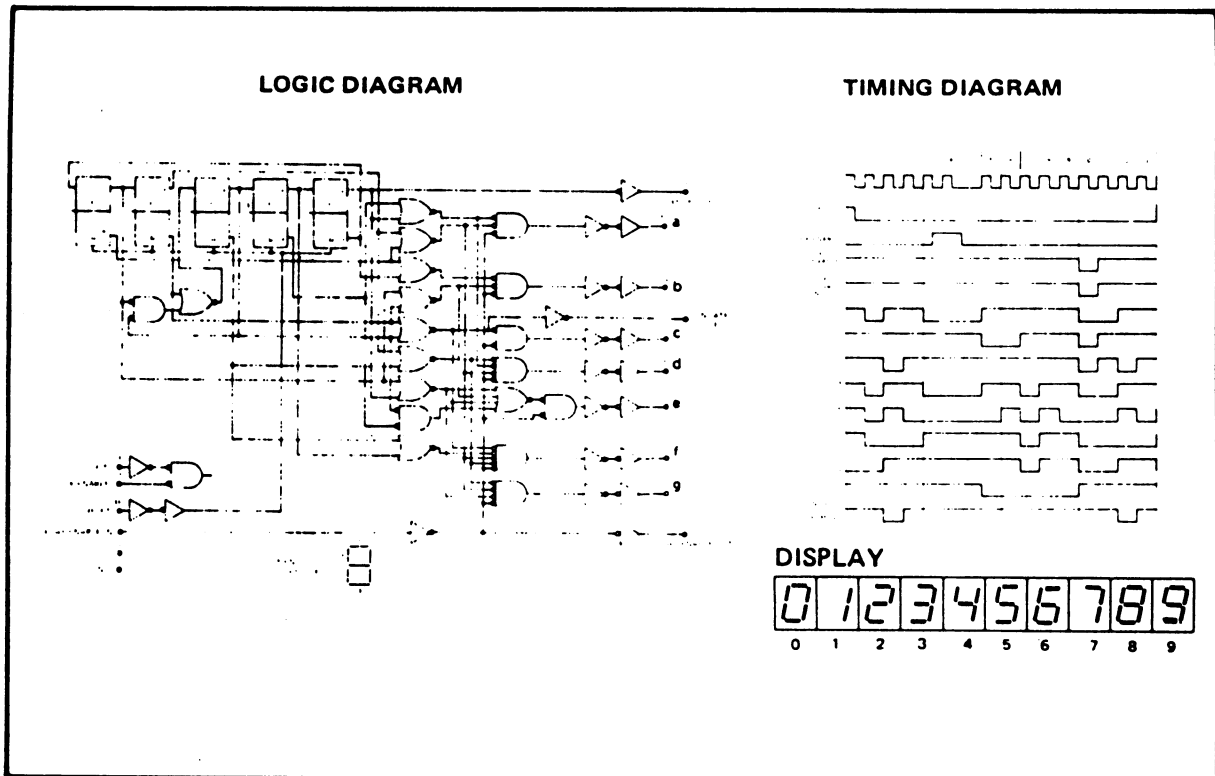

4026AB Decade Counter/7-Segment Decoder with Display Enable

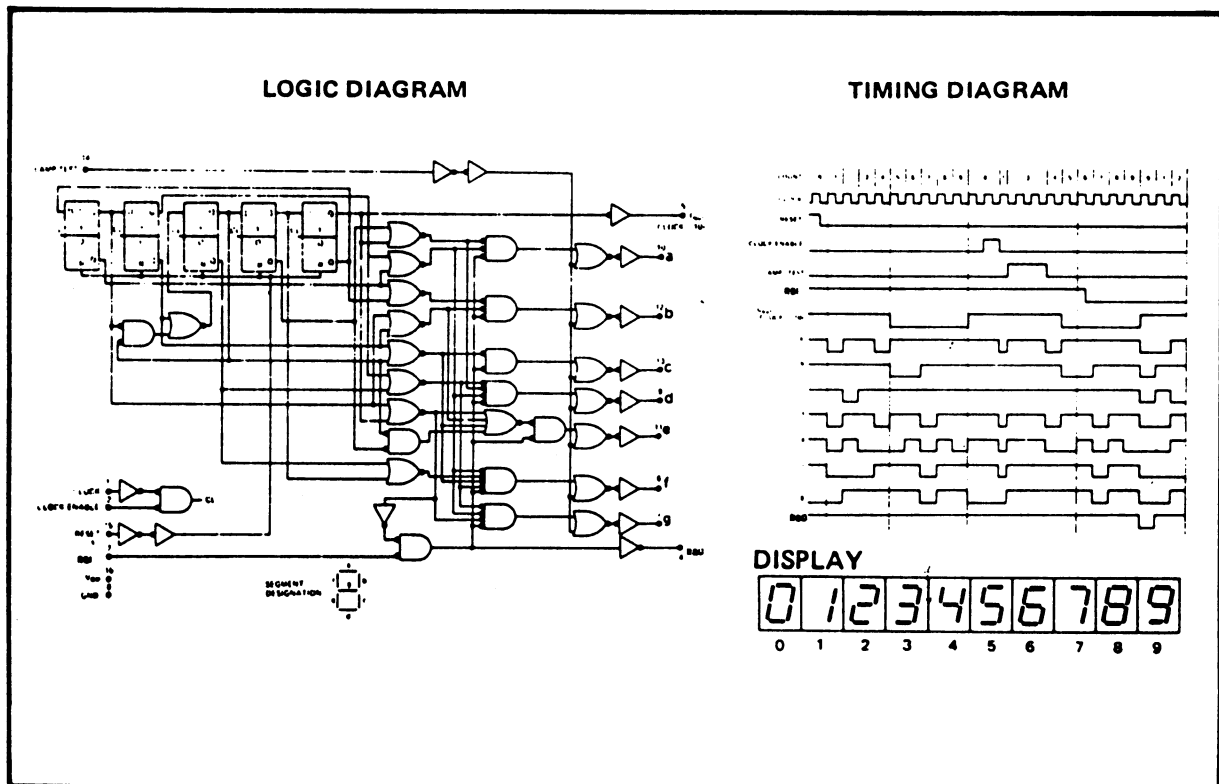

4033AB Decade Counter/7-Segment Decoder with Ripple Blanking