

CMOS QUAD SCHMITT TRIGGER

FEATURES

- ◆ Schmitt Trigger Action on each Input with no External Components
- ◆ Quad 2-Input NAND Configuration
- ◆ Noise Immunity Greater than 50%
- ◆ No Limit on Input Rise and Fall Times

DESCRIPTION

The 4093B consists of four Schmitt trigger circuits. Each circuit functions as a 2-input NAND gate with Schmitt trigger action on both inputs. The gate switches at different points for positive- and negative-going signals. The difference between the positive voltage (V_p) and the negative voltage (V_N) is defined as the hysteresis voltage (V_H). This device is useful in high-noise environments and in wave and pulse shapers and multivibrators.

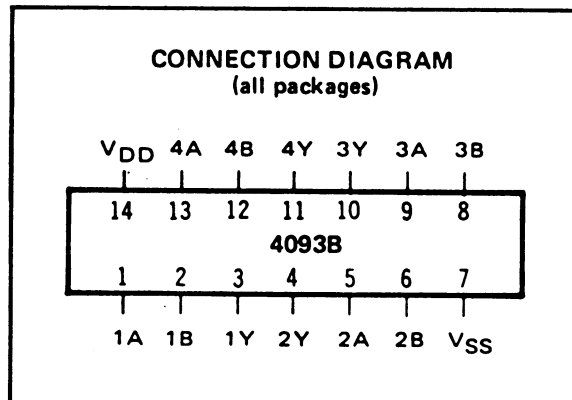

RECOMMENDED OPERATING CONDITIONS

For maximum reliability:

DC Supply Voltage	$V_{DD} - V_{SS}$	3 to 15	Vdc
Operating Temperature	T_A		
C		-55 to +125	°C
E		-40 to +85	°C

LOGIC DIAGRAM

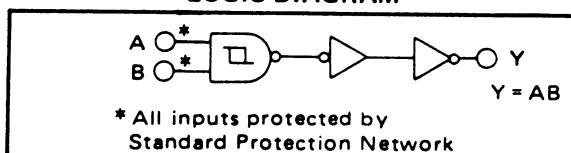

BLOCK DIAGRAM

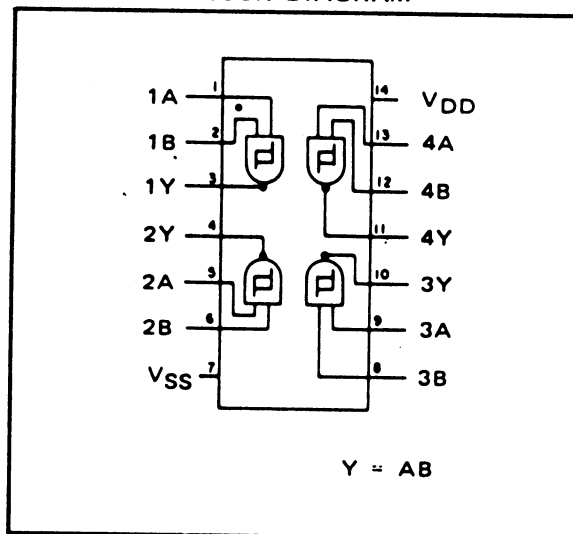

ELECTRICAL CHARACTERISTICS

STATIC CHARACTERISTICS¹

PARAMETER	V _{DD} (Vdc)	CONDITIONS	T _{LOW} ²			+25°C			T _{HIGH} ³			Units	
			Min.	Typ.	Max.	Min.	Typ.	Max.	Min.	Typ.	Max.		
QUIESCENT DEVICE CURRENT	I _{DD}	5	V _{IN} = V _{SS} or V _{DD}	—	—	1.0	—	0.0005	1.0	—	—	30	μA _{dc}
		10	All valid input combinations	—	—	2.0	—	0.001	2.0	—	—	60	
		15		—	—	4.0	—	0.002	4.0	—	—	120	
POSITIVE TRIGGER THRESHOLD VOLTAGE	V _{TP}	5		—	2.9	—	2.3	2.9	3.5	—	2.9	—	Vdc
		10		—	5.3	—	4.5	5.3	7.0	—	5.3	—	
		15		—	7.7	—	6.8	7.7	11.0	—	7.7	—	
NEGATIVE TRIGGER THRESHOLD VOLTAGE	V _{TN}	5		—	2.1	—	1.5	2.1	2.7	—	2.1	—	Vdc
		10		—	4.3	—	3.0	4.3	5.5	—	4.3	—	
		15		—	6.3	—	4.0	6.3	8.2	—	6.3	—	
HYSTERESIS VOLTAGE	V _H	5		0.40	—	2.0	0.40	0.8	2.0	0.40	—	2.0	Vdc
		10		0.70	—	3.0	0.70	1.0	3.0	0.70	—	3.0	
		15		0.85	—	4.0	0.85	1.4	4.0	0.85	—	4.0	

NOTES: ¹ Remaining Static Electrical Characteristics are listed under "4000B Series Family Specifications".

² T_{LOW} = -55°C for C
= -40°C for E

T_{HIGH} = +125°C for C
= +85°C for E

DYNAMIC CHARACTERISTICS (C_L = 50pF, T_A = 25°C)

PARAMETER		V _{DD} (Vdc)	Min.	Typ.	Max.	Units
PROPAGATION DELAY TIME	t _{PLH} , t _{PHL}	5	—	190	380	ns
		10	—	90	180	
		15	—	65	130	
OUTPUT TRANSITION TIME	t _{TLH} , t _{THL}	5	—	100	200	ns
		10	—	50	100	
		15	—	40	80	

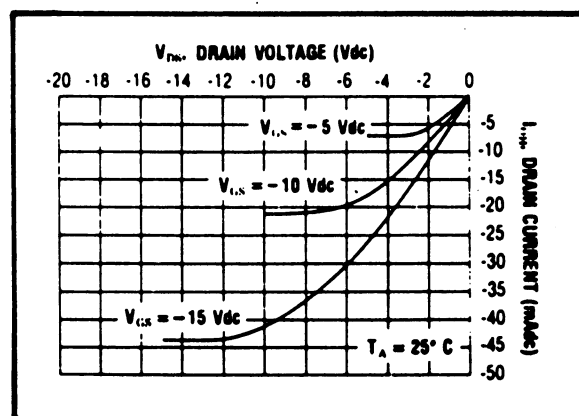

Typical P-Channel
Source Current Characteristics

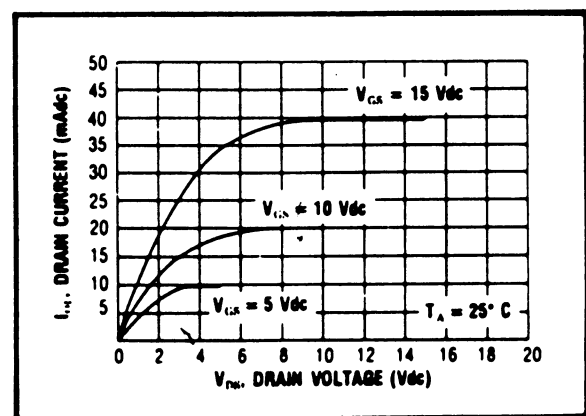

Typical N-Channel
Sink Current Characteristics

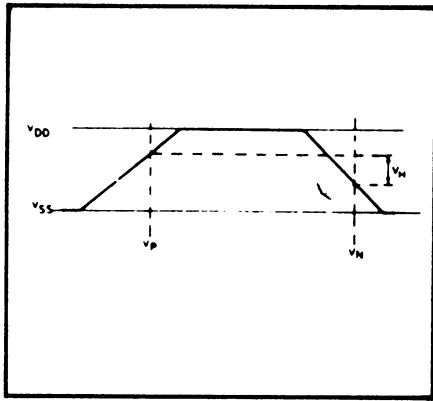

Definition of V_p, V_n and V_h .

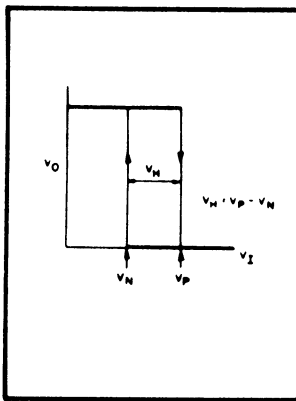

Transfer characteristic of 1 of 4 gates.

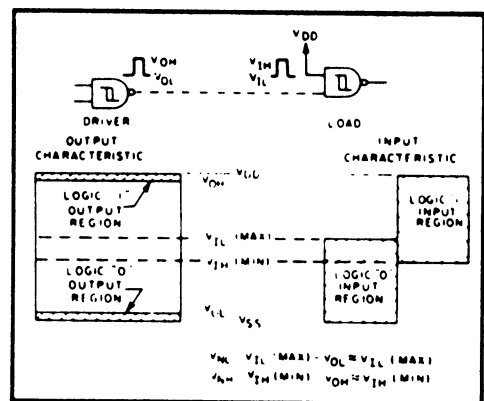

Input and output characteristics.

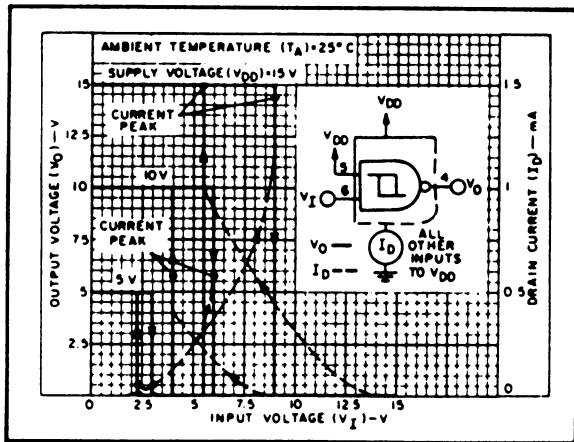

Typical current and voltage transfer characteristics.

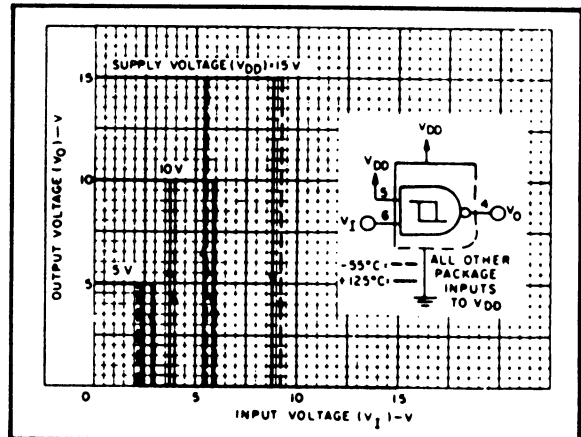

Typical voltage transfer characteristics as a function of temperature.

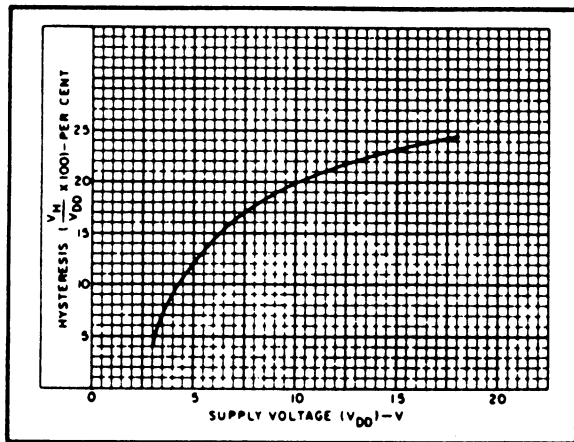

Typical trigger threshold voltage vs. V_{DD} .

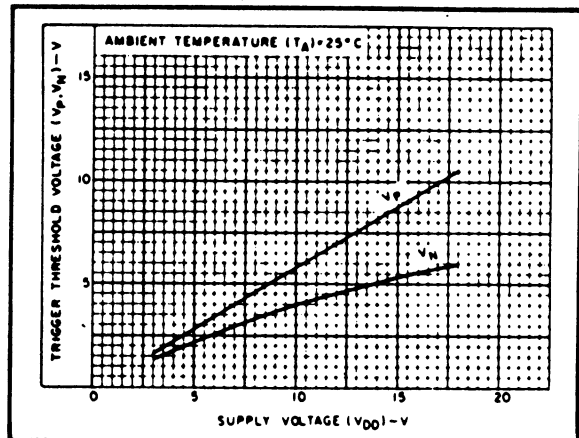

Typical per cent hysteresis vs. supply voltage.

APPLICATIONS INFORMATION

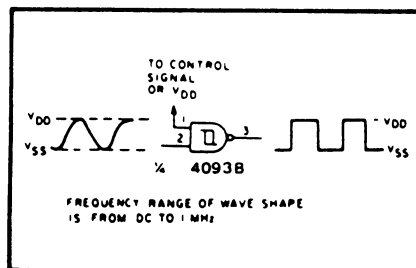

Wave shaper.

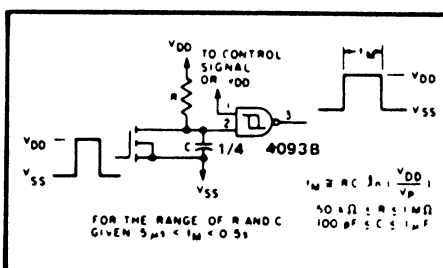

Monostable multivibrator.

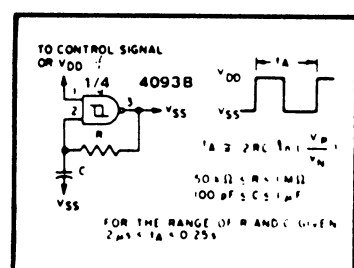

Astable multivibrator.