



GOOD-ARK

40HF(R) SERIES

POWER RECTIFIER

Reverse Voltage - 100 to 1600 Volts

Forward Current - 40.0 Amperes

Features

- High surge current capability
- Designed for a wide range of applications
- Stud cathode and stud anode version
- Leaded version available
- Types up to 1600V V_{RRM}

Typical Applications

- Battery charges
- Converters
- Power supplies
- Machine tool controls



case style
DO-203AB (DO-5)

Mechanical Data

- **Case:** DO-203AB(DO-5)
- **Polarity:** Selection available
- **Weight:** 17 grams

Major Ratings and Characteristics

Parameters		40HF(R)		Units
		10 to 120	140 to 160	
$I_{F(AV)}$		40	40	Amps
	@ T_C	140	110	°C
$I_{F(RMS)}$		62		Amps
I_{FSM}	@50Hz	570		Amps
	@60Hz	595		Amps
I^2t	@50Hz	1600		A ² s
	@60Hz	1450		A ² s
V_{RRM}	range	100 to 1200	1400 to 1600	Volts
T_J	range	-65 to 190	-65 to 160	°C

ELECTRICAL SPECIFICATIONS

Voltage Ratings

Type number	Voltage Code	V_{RRM} maximum repetitive peak reverse voltage Volts	V_{RSM} maximum non-repetitive peak reverse voltage Volts	$V_{R(BR)}$ minimum avalanche voltage Volts ⁽¹⁾	I_{RRM} max. @ $T_J=T_J$ max. mA
40HF(R)	10	100	200	-	15
	20	200	300	-	
	40	400	500	500	
	60	600	720	725	9
	80	800	960	950	
	100	1000	1200	1150	
	120	1200	1440	1350	4.5
	140	1400	1650	1550	
	160	1600	1900	1750	

(1) Avalanche version only available from V_{RRM} 400V to 1600V.

Forward Conduction

Parameter		40HF(R)		Units	Conditions		
		10 to 120	140 to 160				
$I_{F(AV)}$	Max. average forward current @ Case temperature	40	40	Amps	180° conduction, half sine wave		
		140	110	°C			
$I_{F(RMS)}$	Max. RMS forward current	62		Amps			
I_{FSM}	Max. peak, one-cycle forward, non-repetitive surge current	570		Amps	t=10ms	No voltage reapplied	Sinusoidal half wave Initial $T_J=T_J$ max.
		595			t=8.3ms		
		480			t=10ms	100% V_{RRM} reapplied	
		500			t=8.3ms		
I^2t	Maximum I^2t for fusing	1600		A ² S	t=10ms	No voltage reapplied	
		1450			t=8.3s		
		1150			t=10ms	100% V_{RRM} reapplied	
		1050			t=8.3ms		
V_{FM}	Max. forward voltage drop	1.30		Volts	$I_{pk}=125A, T_J=25^\circ C, t_p=400\mu s$ rectangular wave		

Thermal and Mechanical Specifications

Parameter	40HF(R)		Units	Conditions
	10 to 120	140 to 160		
T_J Max. junction operating temperature range	-65 to 190	-65 to 160	°C	
T_{slg} Max. storage temperature range	-65 to 190	-65 to 160		
R_{thJC} Max. thermal resistance, junction to case	1.0		K/W	DC operation
R_{thCS} Max. thermal resistance, case to heatsink	0.25			Mounting surface, smooth, flat and greased
T Max. allowed mounting torque 10%	2.3-2.4		Nm	Not lubricated threads
	20-30		lbf-in	
wt approximate weight	17 (0.6)		g(oz)	
Case style	DO-203AB (DO-5)			See Outline Table

Ordering information Table

Device Code: 40 HF R 160 M
 1 2 3 4 5

1. 40 - Standard device
2. HF - Standard diode
3. None - stud normal polarity (cathode to stud)
 R - stud reverse polarity (Anode to stud)
4. Voltage code: cade x 10= V_{RRM}
5. None - stud base DO-203AB (DO-5) 1/4" 28 UNF-2A
 M - stud base DO-203AB (DO-5) M6x1

Outlines Table

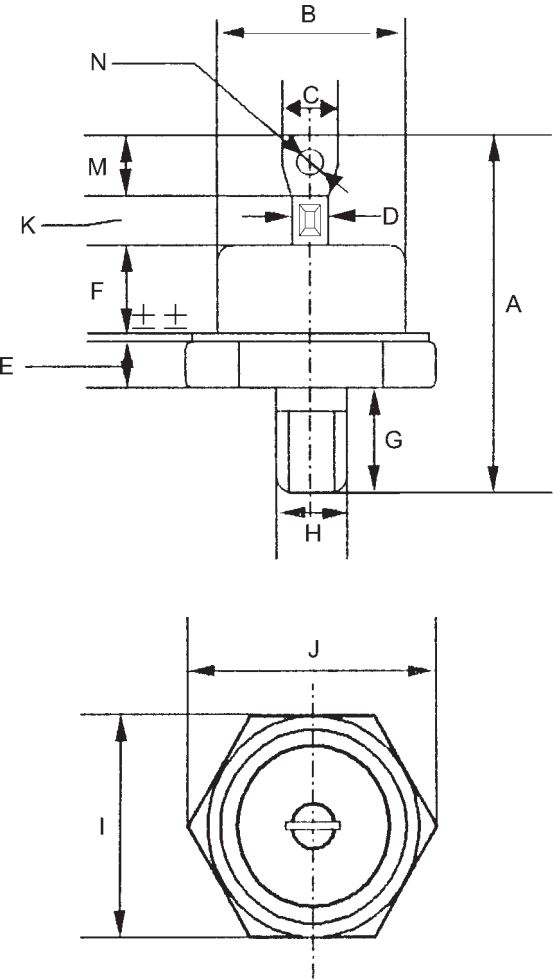

40HF(R)

Case Style DO-203AB(DO-5)
 All dimenions in millimeters(inches)

DIMENSIONS			
DIM	inches	mm	Note
A		34.06	
B		12.83	
C		6.48	
D		3.68	
E		3.30	
F		5.92	
G		11.10	
H		5.84	
I		17.27	
J		19.05	
K		5.38	
M		7.42	
N		φ 3.8	

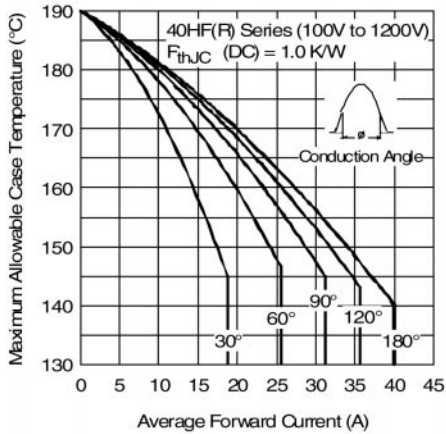

Fig. 1 - Current Ratings Characteristics

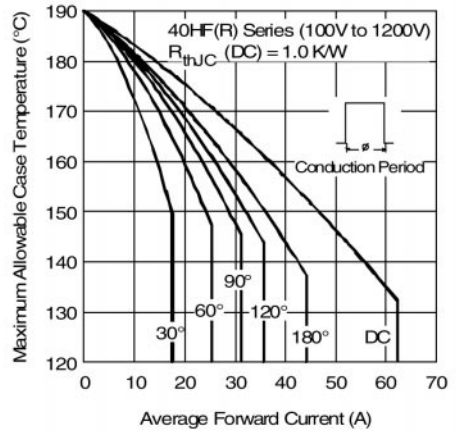

Fig. 2 - Current Ratings Characteristics

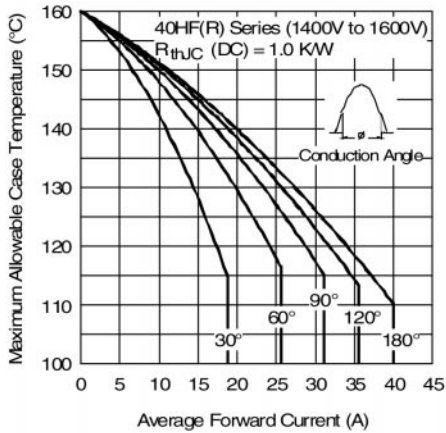

Fig. 3 - Current Ratings Characteristics

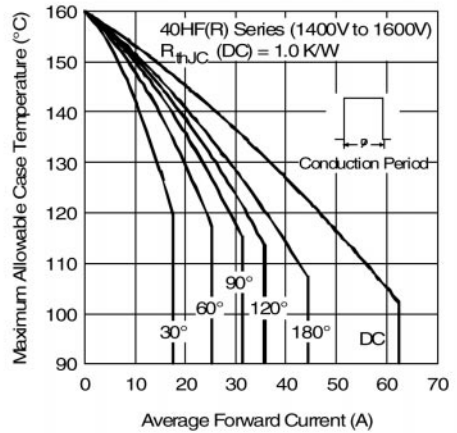

Fig. 4 - Current Ratings Characteristics

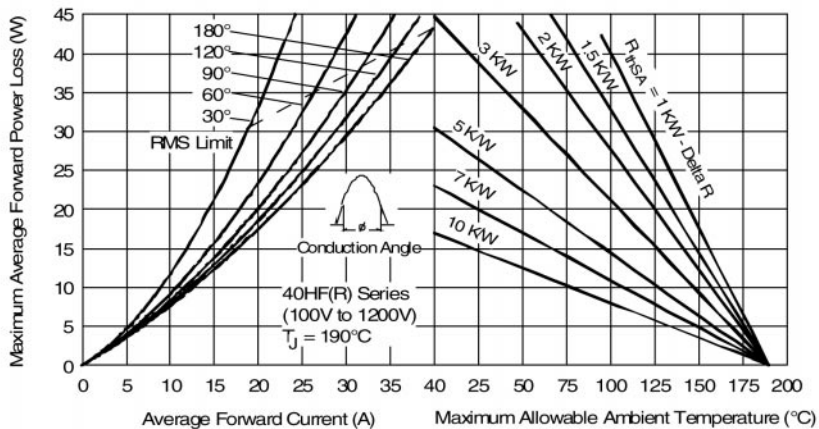

Fig. 5 - Forward Power Loss Characteristics

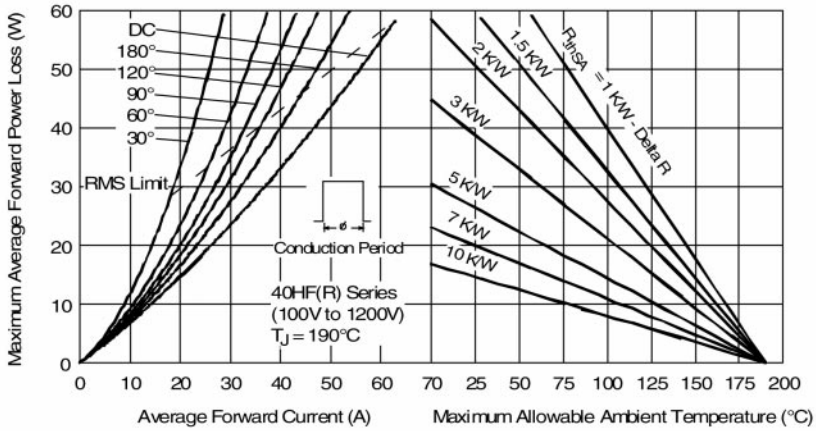

Fig. 6 - Forward Power Loss Characteristics

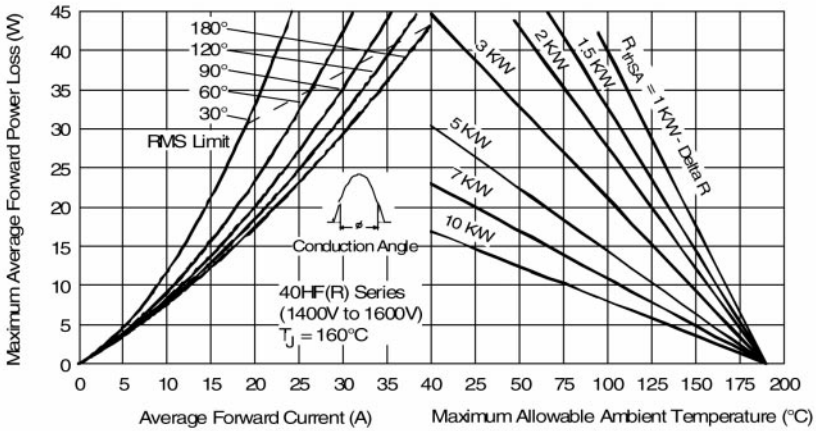

Fig. 7 - Forward Power Loss Characteristics

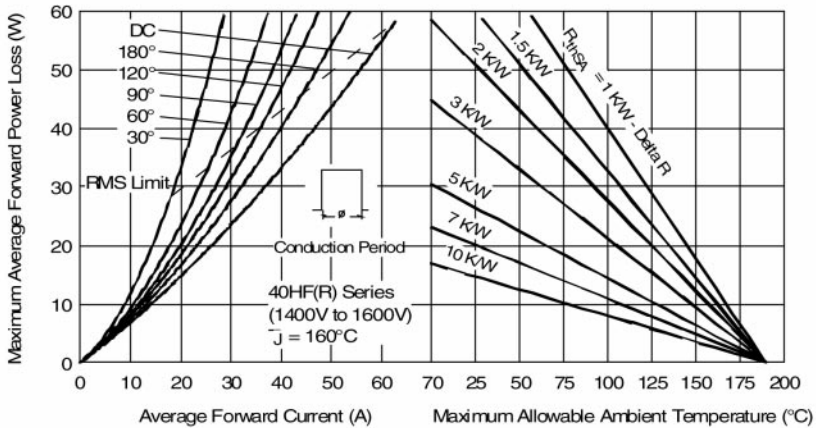

Fig. 8 - Forward Power Loss Characteristics

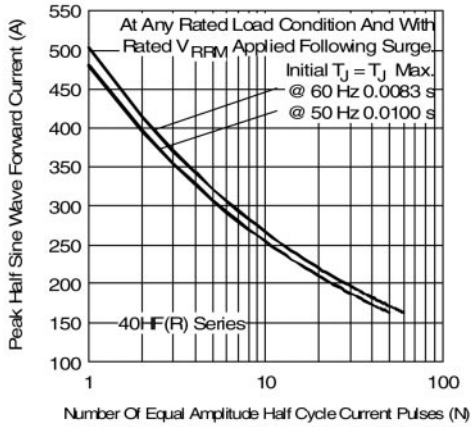

Fig. 9 - Maximum Non-Repetitive Surge Current

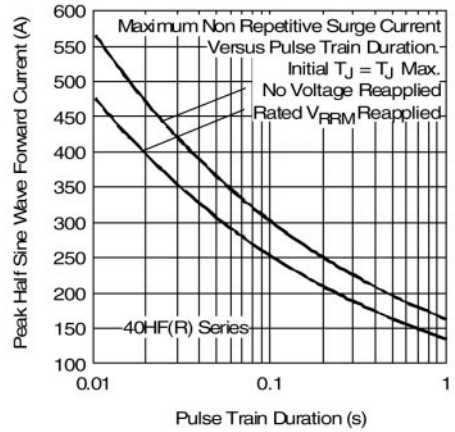

Fig. 10 - Maximum Non-Repetitive Surge Current

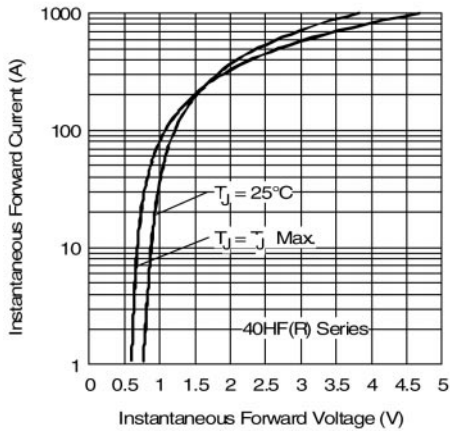

Fig. 11 - Forward Voltage Drop Characteristics

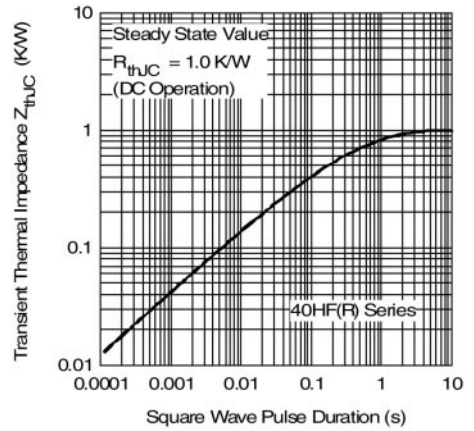

Fig. 12 - Thermal Impedance Z_{thjC} Characteristics