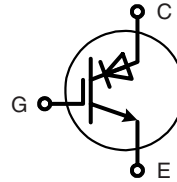
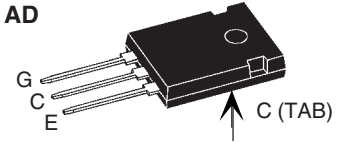

IGBT with Reverse Blocking capability

$$V_{CES} = \pm 1200 \text{ V}$$

$$I_{C25} = 55 \text{ A}$$

$$V_{CE(sat)} = 2.3 \text{ V typ.}$$

TO-247 AD

G = Gate,
E = Emitter,

C = Collector,
TAB = Collector

| IGBT | | | |
|-----------|--|-----------------|---|
| Symbol | Conditions | Maximum Ratings | |
| V_{CES} | $T_{VJ} = 25^{\circ}\text{C to } 150^{\circ}\text{C}$ | ± 1200 | V |
| V_{GES} | | ± 20 | V |
| I_{C25} | $T_C = 25^{\circ}\text{C}$ | 55 | A |
| I_{C90} | $T_C = 90^{\circ}\text{C}$ | 35 | A |
| I_{CM} | $V_{GE} = 0/15 \text{ V}; R_G = 22 \Omega; T_{VJ} = 125^{\circ}\text{C}$ | 80 | A |
| V_{CEK} | RBSOA, Clamped inductive load; $L = 100 \mu\text{H}$ | 600 | V |
| P_{tot} | $T_C = 25^{\circ}\text{C}$ | 300 | W |

Features

- IGBT with NPT (non punch through) structure
- reverse blocking capability
 - function of series diode monolithically integrated, no external series diode required
 - soft reverse recovery
- positive temperature coefficient of saturation voltage
- Epoxy of TO-247 package meets UL 94V-0

Applications

converters requiring reverse blocking capability:

- current source inverters
- matrix converters
- bi-directional switches
- resonant converters
- induction heating
- auxiliary switches for soft switching in the main current path

| Symbol | Conditions | Characteristic Values ($T_{VJ} = 25^{\circ}\text{C}$, unless otherwise specified) | | |
|---------------|--|--|------------|------------------------|
| | | min. | typ. | max. |
| $V_{CE(sat)}$ | $I_C = 30 \text{ A}; V_{GE} = 15 \text{ V}; T_{VJ} = 25^{\circ}\text{C}$ $T_{VJ} = 125^{\circ}\text{C}$ | | 2.3 2.8 | 2.7 V V |
| $V_{GE(th)}$ | $I_C = 2 \text{ mA}; V_{GE} = V_{CE}$ | 4 | | 8 V |
| I_{CES} | $V_{CE} = V_{CES}; V_{GE} = 0 \text{ V}; T_{VJ} = 25^{\circ}\text{C}$ $T_{VJ} = 125^{\circ}\text{C}$ | | 3.0 | 50 μA mA |
| I_{GES} | $V_{CE} = 0 \text{ V}; V_{GE} = \pm 20 \text{ V}$ | | | 500 nA |
| Q_{Gon} | $V_{CE} = 120\text{V}; V_{GE} = 15 \text{ V}; I_C = 35 \text{ A}$ | | 90 | nC |

IGBT

| Symbol | Conditions | Characteristic Values | |
|---|---|--|-----|
| | | (T _{VJ} = 25°C, unless otherwise specified) | |
| | | typ. | |
| External diode DSEP30-12 - diagram see Fig. 17 | | | |
| t _{d(on)} | Inductive load, T _{VJ} = 125°C V _{CE} = 600 V; I _C = 35 A V _{GE} = ±15 V; R _G = 15 Ω | 31 | ns |
| t _r | | 54 | ns |
| t _{d(off)} | | 184 | ns |
| t _f | | 24 | ns |
| E _{on} | | 3.0 | mJ |
| E _{off} | | 0.7 | mJ |
| Internal diode - diagram see Fig. 18 | | | |
| t _{d(on)} | Inductive load, T _{VJ} = 125°C V _{CE} = 600 V; I _C = 35 A V _{GE} = ±15 V; R _G = 15 Ω | 29.5 | ns |
| t _r | | 47 | ns |
| t _{d(off)} | | 183 | ns |
| t _f | | 46 | ns |
| E _{on} | | 19.2 | mJ |
| E _{off} | | 1.0 | mJ |
| E _{rec int} | 7 | mJ | |
| I _{RM} | I _F = 35 A; di _C /dt = -50 A/μs; T _{VJ} = 125°C | 28.5 | A |
| t _{rr} | | V _{CE} = -600 V; V _{GE} = 15 V | 2.1 |
| R _{thJC} | | 0.42 | K/W |

Component

| Symbol | Conditions | Maximum Ratings | |
|------------------|--------------------------|-----------------|----|
| | | | |
| T _{VJ} | | -55...+150 | °C |
| T _{stg} | | -55...+125 | °C |
| M _d | mounting torque | 0.8 - 1.2 | Nm |
| F _C | mounting force with clip | 20...120 | N |

| Symbol | Conditions | Characteristic Values | | |
|-------------------|------------------------|-----------------------|------|------|
| | | min. | typ. | max. |
| R _{thCH} | with heatsink compound | | 0.25 | K/W |
| Weight | | | 6 | g |

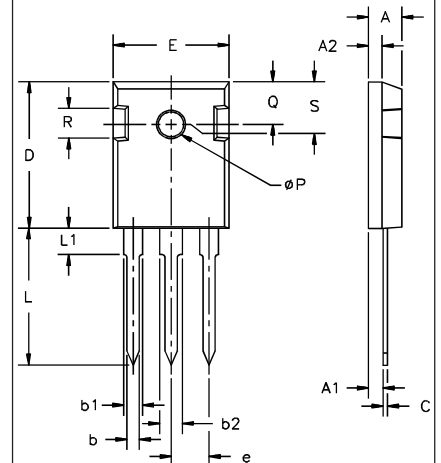
TO-247 AD Outline

| Dim. | Millimeter | | Inches | |
|----------------|------------|-------|--------|-------|
| | Min. | Max. | Min. | Max. |
| A | 4.7 | 5.3 | .185 | .209 |
| A ₁ | 2.2 | 2.54 | .087 | .102 |
| A ₂ | 2.2 | 2.6 | .059 | .098 |
| b | 1.0 | 1.4 | .040 | .055 |
| b ₁ | 1.65 | 2.13 | .065 | .084 |
| b ₂ | 2.87 | 3.12 | .113 | .123 |
| C | .4 | .8 | .016 | .031 |
| D | 20.80 | 21.46 | .819 | .845 |
| E | 15.75 | 16.26 | .610 | .640 |
| e | 5.20 | 5.72 | 0.205 | 0.225 |
| L | 19.81 | 20.32 | .780 | .800 |
| L1 | | 4.50 | | .177 |
| ∅P | 3.55 | 3.65 | .140 | .144 |
| Q | 5.89 | 6.40 | 0.232 | 0.252 |
| R | 4.32 | 5.49 | .170 | .216 |
| S | 6.15 | BSC | 242 | BSC |

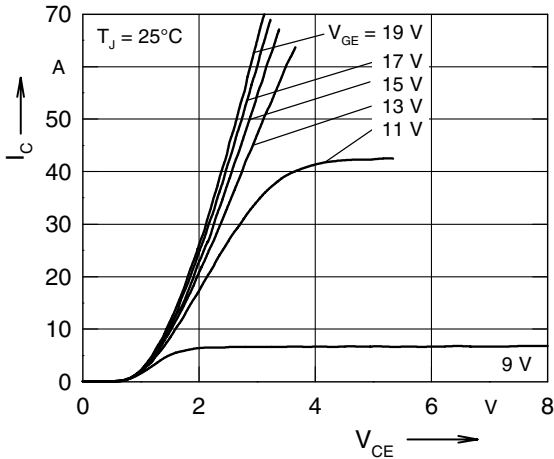

Fig. 1 Typical output characteristics

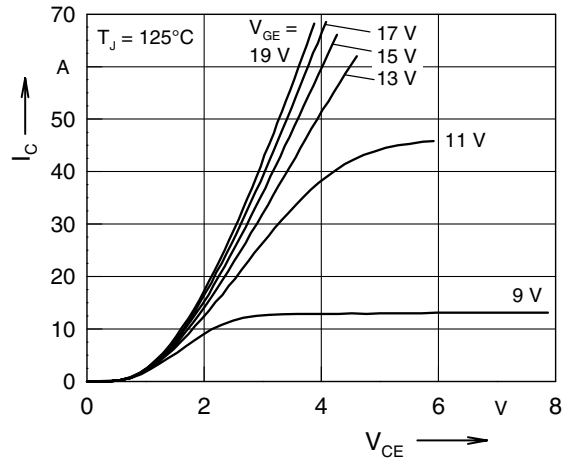

Fig. 2 Typical output characteristics

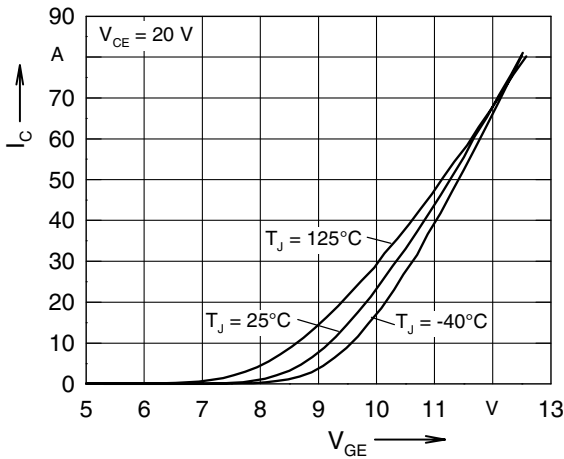

Fig. 3 Typical transfer characteristics

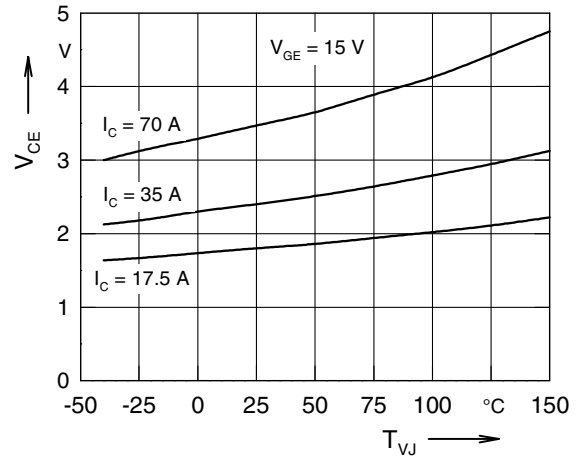

Fig. 4 Typ. collector emitter saturation as a function of case temperature

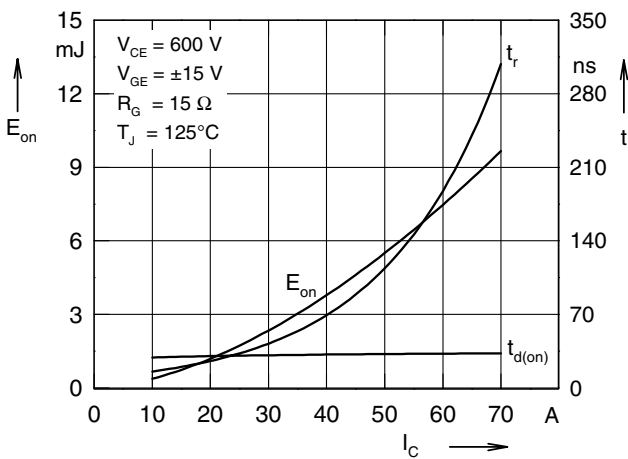

Fig. 5 Typ. turn on energy and switching times vs. collector current, inductive switching with ext. free wheeling diode (Fig. 17)

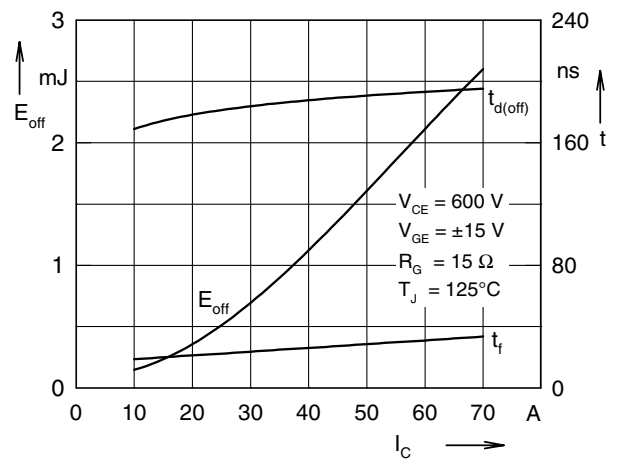

Fig. 6 Typ. turn off energy and switching times vs. collector current, inductive switching with ext. free wheeling diode (Fig. 17)

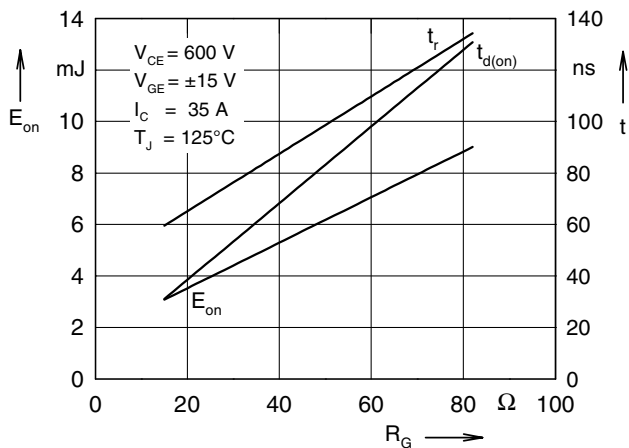

Fig. 7 Typ. turn on energy and switching times vs. gate resistor, inductive switching with ext. free wheeling diode (Fig. 17)

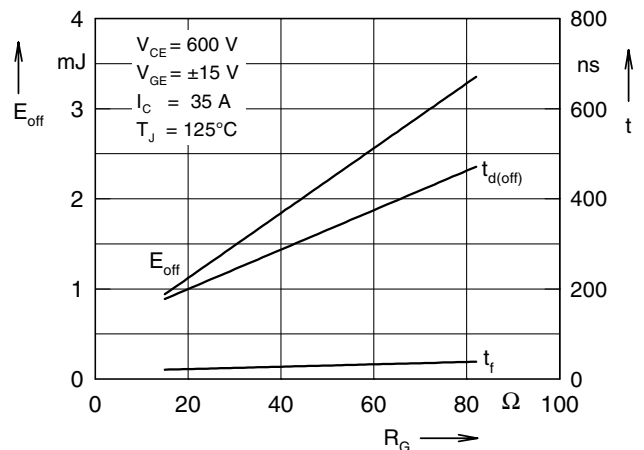

Fig. 8 Typ. turn off energy and switching times vs. gate resistor, inductive switching with ext. free wheeling diode (Fig. 17)

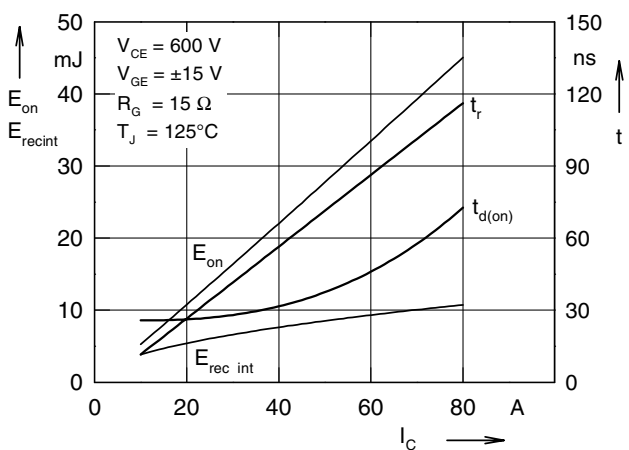

Fig. 9 Typ. turn on energy and switching times vs. collector current, inductive switching with internal diode (Fig. 18)

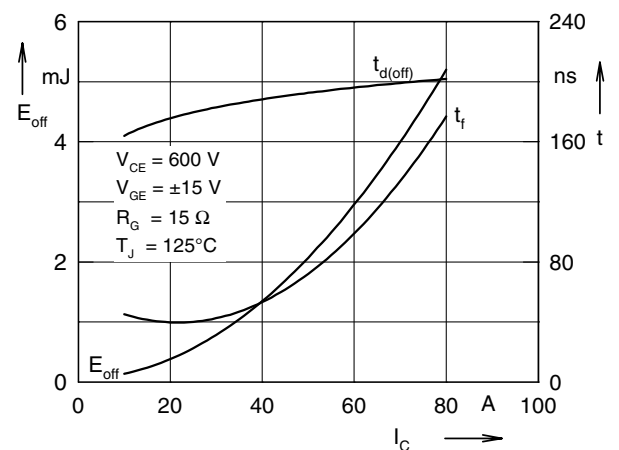

Fig. 10 Typ. turn off energy and switching times vs. collector current, inductive switching with internal diode (Fig. 18)

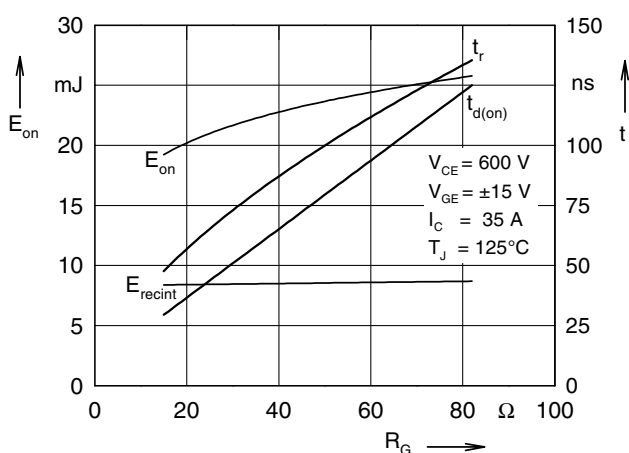

Fig. 11 Typ. turn on energy and switching times vs. gate resistor, inductive switching with internal diode (Fig. 18)

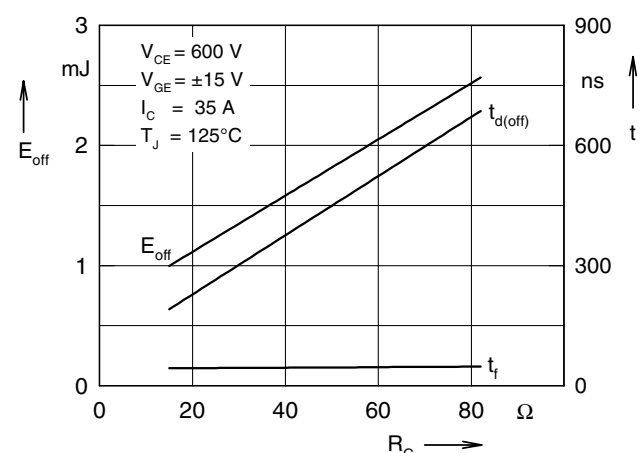

Fig. 12 Typ. turn off energy and switching times vs. gate resistor, inductive switching with internal diode (Fig. 18)

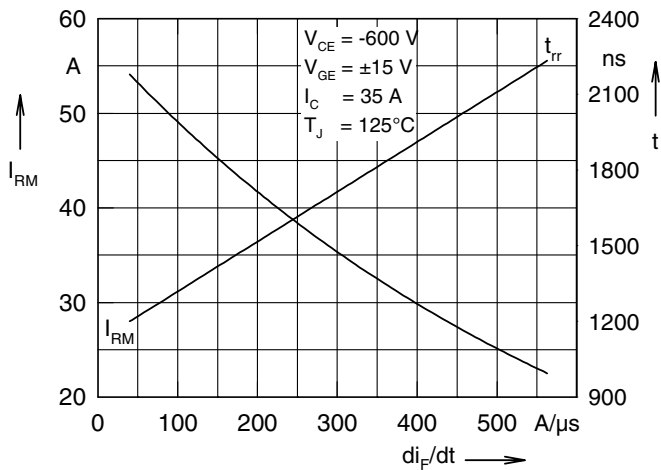

Fig. 13 Typ. turn off characteristics of the internal diode

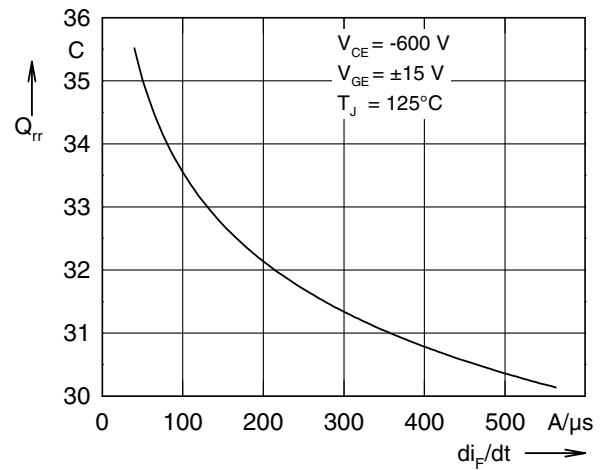

Fig. 14 Typ. turn off characteristics of the internal diode

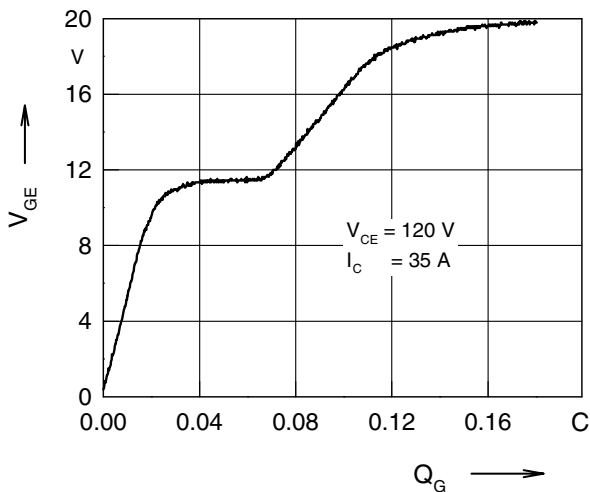

Fig. 15 Typical gate charge

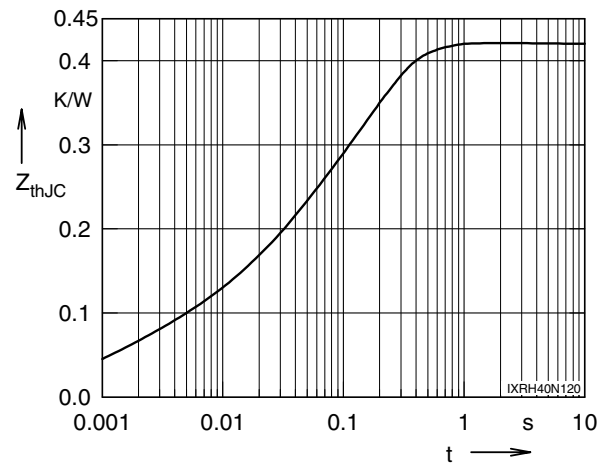

Fig. 16 Typ. transient thermal impedance

| | | | | | |
|----|--------|--------|-------|-------|-------|
| Ri | 0.034 | 0.048 | 0.092 | 0.174 | 0.075 |
| τ | 0.0001 | 0.0035 | 0.02 | 0.142 | 0.18 |

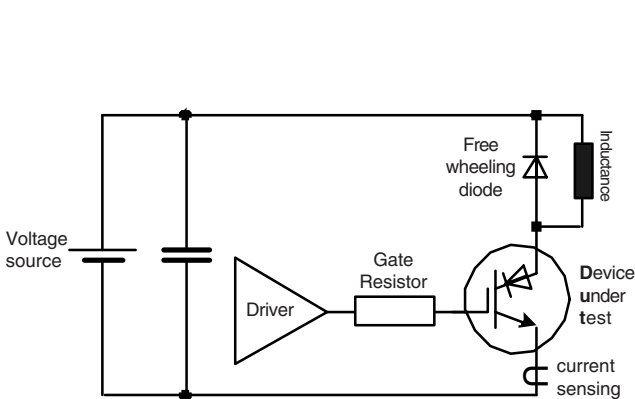

Fig. 17 turn-on/turn-off with external diode (DSEP 30-12)

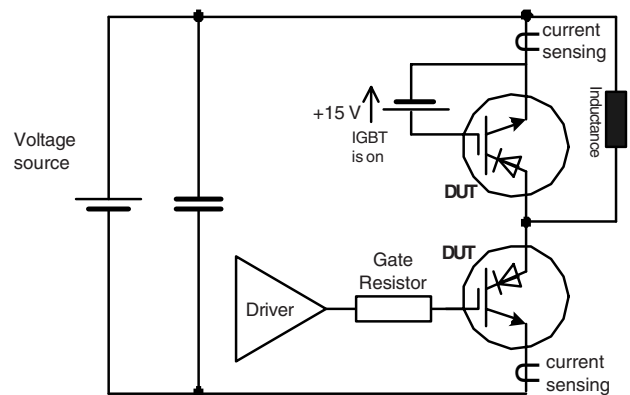

Fig. 18 turn-on/turn-off with internal diode