

**TOSHIBA**

FILE NO. 030-200001

SERVICE MANUAL

COLOUR TELEVISION

C9PJ Chassis

***40PW03G, 40PW03B***

# TABLE OF CONTENTS

## CHAPTER 1 GENERAL ADJUSTMENTS

SAFETY INSTRUCTIONS .....	3
CRT ASSEMBLY REPLACEMENT AND MOUNTING .....	4
PICTURE TUBE COMPONENTS ADJUSTMENT .....	6
SERVICE POSITION .....	9
SERVICE MODE .....	10
DESIGN MODE .....	13
ELECTRICAL ADJUSTMENT .....	14
CONVERGENCE ADJUSTMENT .....	23
SCREEN AND MIRROR ALIGNMENTS .....	32
CIRCUIT CHECKS .....	33

## CHAPTER 2 SPECIFIC INFORMATIONS

SETTING & ADJUSTING DATA .....	34
LOCATION OF CONTROLS .....	35
CIRCUIT BLOCK DIAGRAM .....	37
MECHANICAL DISASSEMBLY .....	38
CHASSIS AND CABINET REPLACEMENT PARTS LIST .....	39
PC BOARDS BOTTOM VIEW.....	59
TERMINAL VIEW OF TRANSISTORS .....	73
SPECIFICATIONS .....	75

### APPENDIX:

CIRCUIT DIAGRAM

## SAFETY INSTRUCTIONS

**WARNING:** BEFORE SERVICING THIS CHASSIS, READ THE "X-RAY RADIATION PRECAUTION", "SAFETY PRECAUTION" AND "PRODUCT SAFETY NOTICE" INSTRUCTIONS BELOW.

### X-RAY RADIATION PRECAUTION

1. Excessive high voltage can produce potentially hazardous X-RAY RADIATION. To avoid such hazards, the high voltage must not be above the specified limit. The nominal value of the high voltage of this receiver is (A) kV at zero beam current (minimum brightness) under a (C) V AC power source. The high voltage must not, under any circumstances, exceed (B) kV.
2. The only source of X-RAY RADIATION in this TV receiver is the picture tube. For continued X-RAY RADIATION protection, the replacement tube must be exactly the same type tube as specified in the parts list.
3. Some part in this receiver have special safety-related characteristics for X-RAY RADIATION protection. For continued safety, parts replacement should be undertaken only after referring to the PRODUCT SAFETY NOTICE below.

Refer to table-1 for high voltage (A), (B) & AC voltage (C).  
(See SETTING & ADJUSTING DATA on page 34)

Each time a receiver requires servicing, the high voltage should be checked following the HIGH VOLTAGE CHECK procedure in this manual. It is recommended that the reading of the high voltage be recorded as a part of the service record. It is important to use an accurate and reliable high voltage meter.

### SAFETY PRECAUTION

**WARNING :** Service should not be attempted by anyone unfamiliar with the necessary precautions on this receiver. The following are the necessary precautions to be observed before servicing this chassis.

1. An isolation transformer should be connected in the power line between the receiver and the AC line before any service is performed on the receiver.
2. Always discharge the picture tube anode to the CRT conductive coating before handling the picture tube. The picture tube is highly evacuated and if broken, glass fragments will be violently expelled. Use shatter proof goggles and keep picture tube away from the unprotected body while handling.
3. When replacing a chassis in the cabinet, always be certain that all the protective devices are put back in place, such as; non-metallic control knobs, insulating covers, shields, isolation resistor-capacitor network etc.

### PRODUCT SAFETY NOTICE

Many electrical and mechanical parts in this chassis have special safety-related characteristics. These characteristics are often passed unnoticed by a visual inspection and the protection afforded by them cannot necessarily be obtained by using replacement components rated for higher voltage, wattage, etc. Replacement parts which have these special safety characteristics are identified in this manual and its supplements; electrical components having such features are identified by the international hazard symbols on the schematic diagram and the parts list.

Before replacing any of these components, read the parts list in this manual carefully. The use of substitute replacement parts which do not have the same safety characteristics as specified in the parts list may create shock, fire, X-ray radiation or other hazards.

## CRT ASSEMBLY REPLACEMENT AND MOUNTING

**CAUTION :** DO NOT LOOSEN THE HEX HEAD BOLTS WITH SPRINGS (12 PCS), BECAUSE THOSE ARE FOR SEALING OF CRT COOLANT.

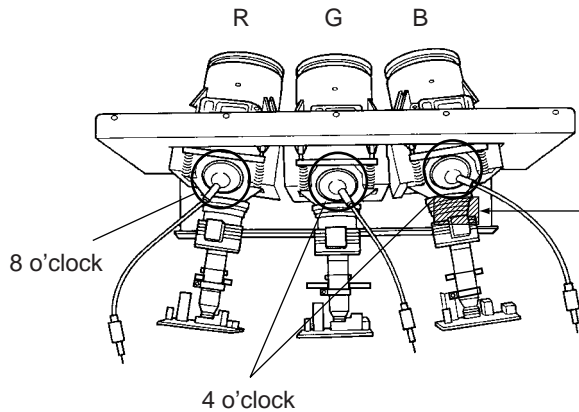

### Attention Serviceman

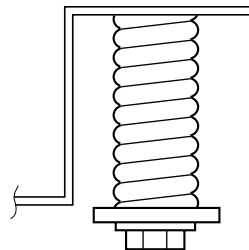

The Hex Head Bolts with Springs. (see sketch) used on CRT assembly, are "NOT"

Adjustment Screws  
**DO NOT LOOSEN-FLUID LEAKAGE WILL OCCUR.**

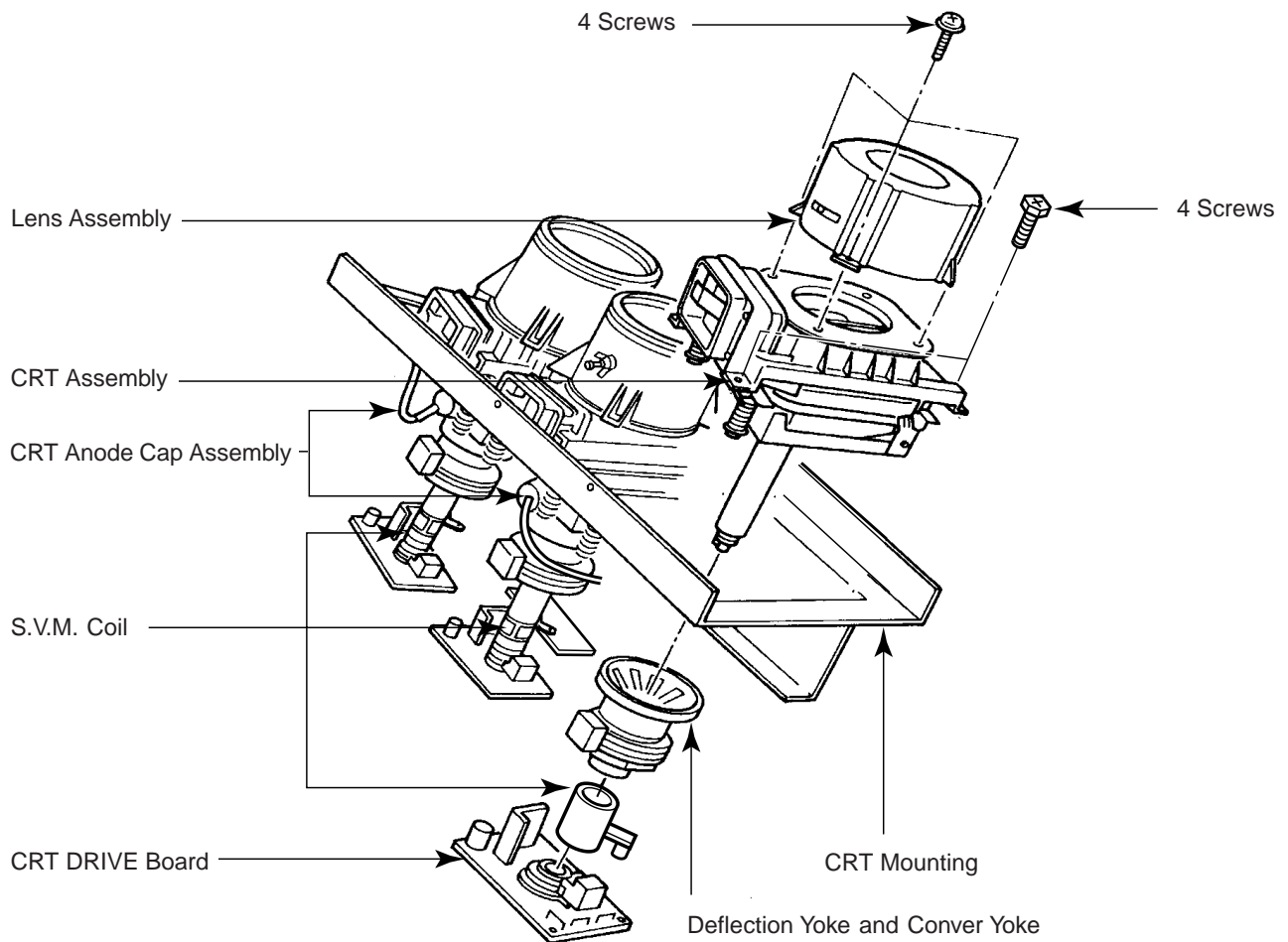

Lens and Neck Components View

TO REMOVE CRT (Same procedure for R, G, B)

1. Remove CRT DRIVE Board, S. V. M. COIL and DEF. YOKE from CRT.
2. Remove Lens Assembly.
3. Detach CRT Anode Cap from CRT.
4. Remove CRT Assembly from CRT Mounting.

CRT REPLACEMENT (Same procedure for R, G, B)

Reverse the removal procedures except the followings.

1. Anode Cable should be replaced with new one.  
See "SERVICING PRECAUTIONS" shown below.
2. Install silicon (T461B) to the CRT, replace the Anode cable and put enough silicon again on around the Anode Cap as illustrated.

CAUTION: Align the Anode cable as illustrated on page 4.

ADJUSTING PROCEDURE IN REPLACING CRT

1. R.G.B. CUTOFF (SCREEN VR) ADJUSTMENT (page 6.)
  2. R.G.B. FOCUS ADJUSTMENT (page 6.)
  3. PICTURE TILT ADJUSTMENT (page 7.)
  4. USER CONVERGENCE CENTER CHECK  
(Refer to owner's manual.)
  5. CENTERING ADJUSTMENT (page 7.)
  6. CONVERGENCE ADJUSTMENT (page 23.)
  7. WHITE BALANCE ADJUSTMENT (page 15.)
- Adjustments are complete.

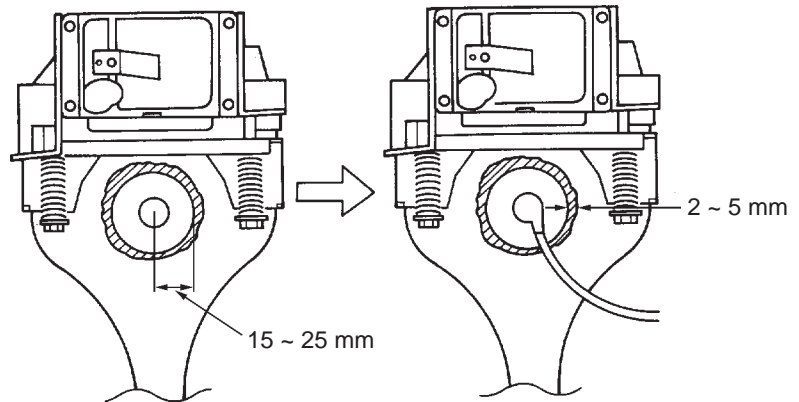
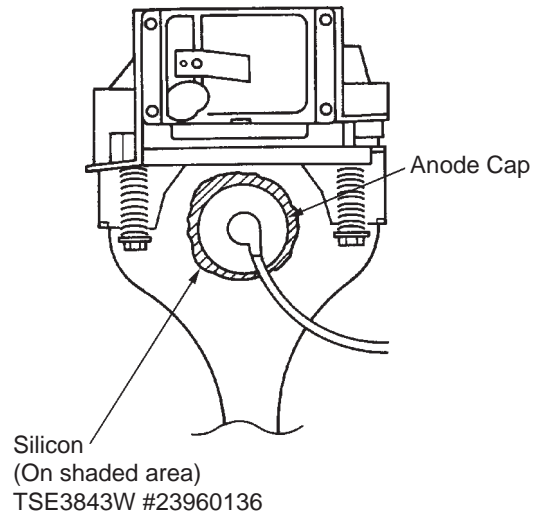

## SERVICING PRECAUTIONS

- Do not use a magnetized screw driver for screws of Deflection Yoke and Velocity Modulation Coil to avoid magnetization of electron gun. Magnetization of electron gun will degrade basic function and result in unbalance of right and left shift of user static convergence, and result in no variable quantity.

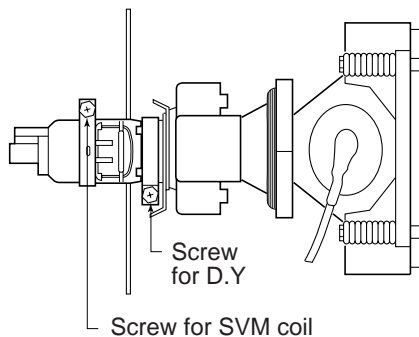

- When replacing the anode cap assembly (CRT) or anode lead assembly (F.B.T.), remove the anode lead holder from old one and attach the holder again to new anode lead.

- Check the point of anode lead in a straight line, if it is winding, please revise it.

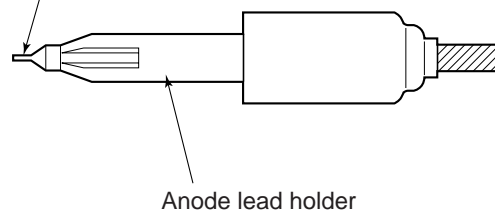

**WARNING:** BEFORE SERVICING THIS CHASSIS, READ THE "X-RAY RADIATION PRECAUTION", "SAFETY PRECAUTION" AND "PRODUCT SAFETY NOTICE" ON PAGE 3 OF THIS MANUAL.

## PICTURE TUBE COMPONENTS ADJUSTMENT

### ADJUSTING PROCEDURE IN REPLACING CRT

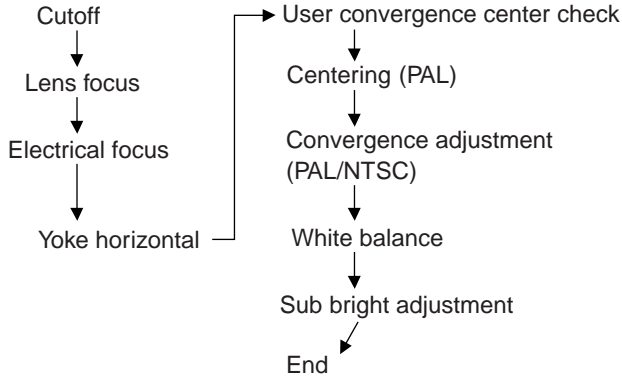

### RGB FOCUS ADJUSTMENT

1. Call-up the adjustment mode (see page 10)
2. Press  $\ominus$  button on the remote controller in order to display the internally-generated cross-hatch (See TEST SIGNAL SELECTION on page 11.)
3. Expose only RED by covering the GREEN and BLUE lenses with caps.
4. Loosen the RED lens fixing screws (refer to Fig. a), and adjust the RED lens focus to obtain the sharpest point while observing the middle and peripheral sections of the screen.

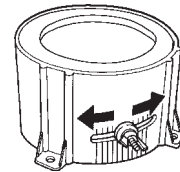
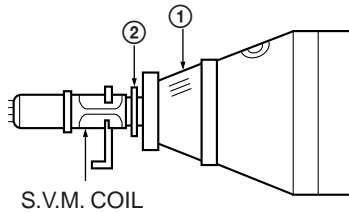

Fig. a

### DESCRIPTION OF NECK COMPONENTS



- ① Deflection yoke and convergence yoke.  
The position on the neck is required most front (CRT funnel side) and the screw is fastened after rotating yoke adjusting picture tilt.
- ② Centering magnet  
After adjusting picture tilt, picture position is finally fixed by this magnet.  
In order to get maximum margin of user convergence control for center of screen, this magnet have to be used for center convergence adjustment.

#### PREPARATION

Operate the receiver for at least 5 minutes.

### R, G, B CUTOFF (SCREEN VR) ADJUSTMENT

1. Adjust before replace the screen assembly.
2. Set user control to reset position.  
( CONTRAST → Max  
BRIGHTNESS, COLOR, TINT → Center. )
3. Call up the adjustment mode display, then select the item RCUT.
4. Adjust the data of items **RCUT**, **GCUT**, and **BCUT** to "40H".
5. Press the  $\text{---}$  button on Remote. (Y-MUTE : ON)
6. Gradually rotate R, G and B screen volume of FOCUS PAC clockwise or counterclockwise until the raster appears slightly on the CRT through the each lens, and leave them.  
(Lookin to the lens in order to check the raster.)
7. Press the  $\text{---}$  button on Remote. (Return to Normal Picture)

5. Use the focus VR of "R" of the focus pack in order to adjust the electric focus in the middle and peripheral sections of the screen to its sharpest level.
6. Check the RED focus of the whole screen and if necessary repeat steps 4 and 5.
7. Fix the RED lens by tightening its fixing screws.
8. Expose only GREEN by covering the RED and BLUE lenses with caps.
9. Display the internally-generated cross-hatch signal.
10. Adjust the GREEN lens focus on the left border of the screen to its sharpest level, then check the focus on the right border, and if it is at its sharpest level, fix it in that position by tightening the lens screws.

- (1) If the horizontal line toward the right border is red-flared, turn the lens screw slightly right in order to balance it with the left border. (After adjustment, the left border tends to be slightly green-flared, and the right border tends to be slightly red-flared.)
- (2) If the horizontal line toward the right border is green-flared, turn the lens screw slightly left in order to balance it with the left border. (After adjustment, the left border tends to be slightly red-flared, and the right border tends to be slightly green-flared.)

Note: The aim of the above-described adjustment procedure for the Green lens focus is to obtain the best lens focus after 2 - 3 hours of warming up taking into account the focus drift; it applies if the warming up time before the adjustment is less than 30 minutes. (The horizontal line in the screen middle section tends to be slightly red-flared.)

In case of warming up of more than 2 hours under a condition that the large anode current is running through the projection tube so that for example the all-white pattern appears, adjust to obtain the sharpest focus while observing the whole screen like in the RED case.

- Press  $\ominus$  button on the remote controller in order to display the internally-generated black cross-hatch. (See TEST SIGNAL SELECTION on page 11.)

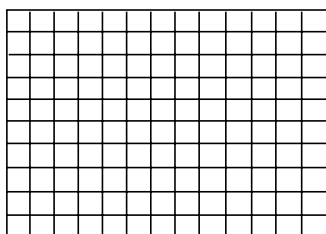

- Use the focus VR of "G" of the focus pack in order to adjust the electric focus in the middle section of the screen to its sharpest level.

Note: Normally the most clearly visible point of the scanning line is the sharpest point of the Green focus, however as the characteristics vary depending on the projection tube, the sharpest focus points of the vertical and horizontal lines may not match each other, thus when you turn the focus VR, if the picture tends to be tremendously unstable (rolls horizontally or vertically), adjust the balance of the vertical and horizontal lines to its best position.

- Check the GREEN focus of the whole screen and if necessary repeat steps 10 and 11.
- Fix the GREEN lens by tightening up its fixing screws.
- Expose only BLUE by covering the RED and GREEN lenses with caps.
- Press  $\ominus$  button on the remote controller in order to display the internally-generated cross-hatch (See TEST SIGNAL SELECTION on page 11.)
- Loosen the BLUE lens fixing screws (refer to Fig. a), and adjust the BLUE lens focus while observing the middle and peripheral screen sections.
- Press  $\ominus$  button on the remote controller in order to display the internally-generated black cross-hatch (See TEST SIGNAL SELECTION on page 11.)
- Use the focus VR of "B" of the focus pack in order to adjust the focus in the middle section of the screen to its sharpest level.

(The point of the Blue focus becomes sharpest when the brightness level of BLUE is lowest, the cross-hatch is clearly visible.)

Note: Keep in mind that only the BLUE electric focus is adjusted with the black cross-hatch.

- Check the BLUE focus of the whole screen and if necessary repeat steps 17 and 19.
- Fix the BLUE lens by tightening its fixing screws.

#### TILT ADJUSTMENT

Rotate R, G, B deflection yoke so that picture becomes horizon, then fasten screw.

#### CENTERING ADJUSTMENT

- Stretch a thread between two center slots of screen edge (top and bottom, left and right).

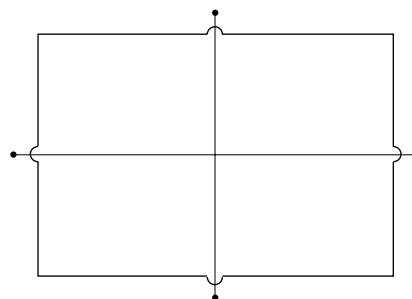

- Select the adjustment mode. (See page 10.)
- Press TV/VIDEO button on the Remote Control to display the black cross-hatch.

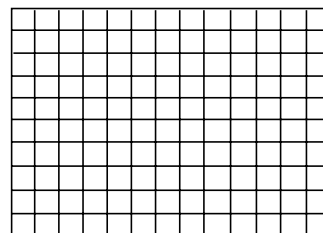

- Adjust G centering magnet so that the cross-hatch pattern center comes to screen center.
- Perform HEIGHT adjustment. (See page 14.)
- Perform WIDTH adjustment. (See page 14.)
- Check whole quality of green line.
- Adjust R, B centering magnet so that the cross-hatch pattern center comes to screen center.

## LOCATION OF SCREEN AND FOCUS VR'S

To remove the Speaker grille and Front panel.

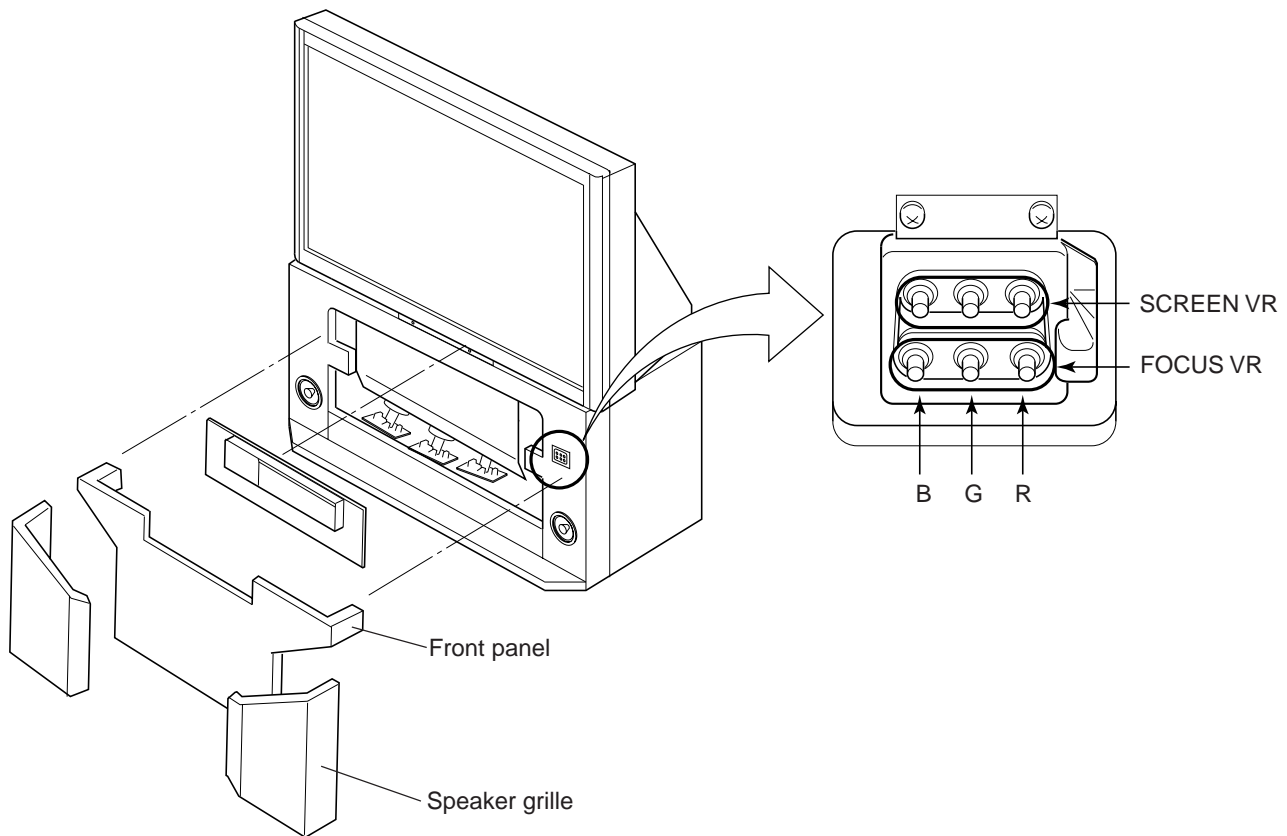

## REPLACEMENT OF HIGH VOLTAGE CABLE

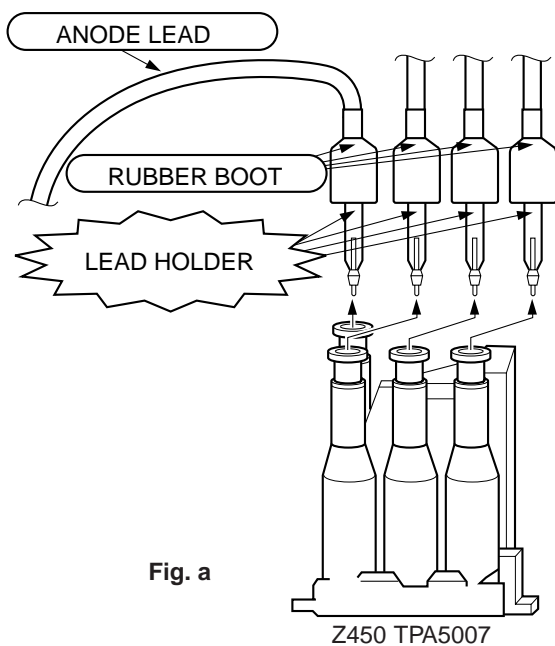

Fig. a

1. When replacing Anode Lead or Anode Cap with new one, remove Lead Holder from old lead as shown in figure below, and put it on new lead. Do not throw away Lead Holder.

**NOTE : THE LEAD HOLDER IS ATTACHED TO TPA5007 (Z450), BUT IS NOT ATTACHED TO ANODE LEAD AND ANODE CAP. RUBBER BOOT IS ATTACHED TO ANODE LEAD AND ANODE CAP.**

2. Detaching Lead Holder

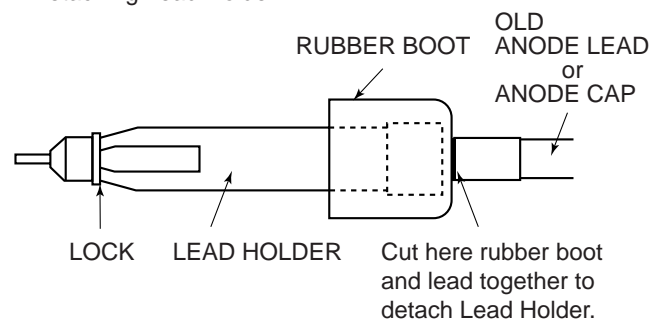

Fig. b



**WARNING:** BEFORE SERVICING THIS CHASSIS, READ THE "X-RAY RADIATION PRECAUTION", "SAFETY PRECAUTION" AND "PRODUCT SAFETY NOTICE" ON PAGE 3 OF THIS MANUAL.

## SERVICE POSITION

In order to assure the performance, processed wires shall be replaced after the repair work.

Work procedures are as follows:

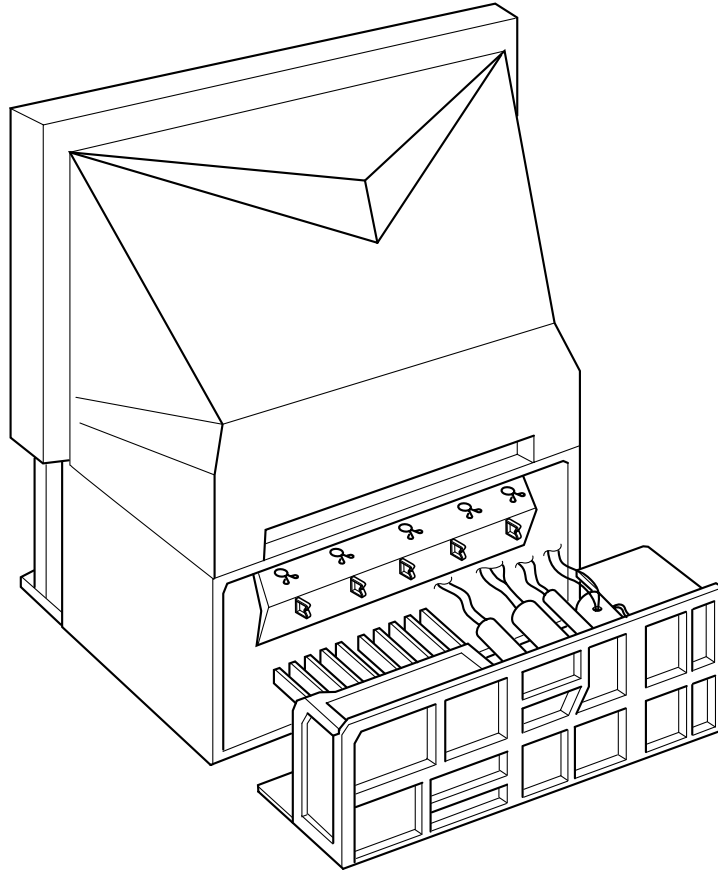

1. Remove the back board.
2. Remove lead wires.
3. Draw out the chassis.
4. Rest the chassis against the back cabinet, chassis as shown bellow.

After repair work finished, replace it in the opposite procedure.



# SERVICE MODE

## 1. ENTERING TO SERVICE MODE

- 1) Press  button once on Remote Control.
- 2) Press  button again to keep pressing.
- 3) While pressing the  button, press MENU button on TV set.

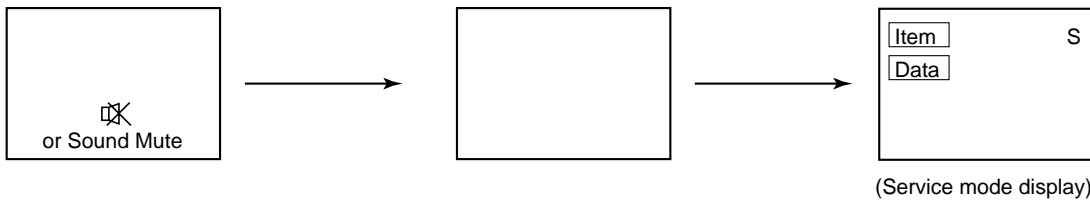

## 2. DISPLAYING THE ADJUSTMENT MENU

- 1) Press MENU button on TV.

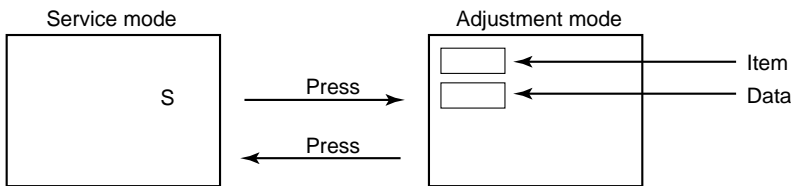

## 3. KEY FUNCTION IN THE SERVICE MODE

The following key entry during display of adjustment menu provides special functions.

Screen adjustment mode ON/OFF :	-/-- button (on Remote)
Test signal selection :	⊖ button (on Remote)
Selection of the adjustment items :	Channel ▲/▼ (on TV or Remote)
Change of the data value :	Volume ▲/– (on TV or Remote)
Adjustment menu mode ON/OFF :	MENU button (on TV)
Initialization of the memory (QA02) :	CALL + Channel button on TV (▲)
Reset the count of operating protect circuit to “00”:	CALL + Channel button on TV (▼)
“RCUT” selection :	1 button
“GCUT” selection :	2 button
“BCUT” selection :	3 button
“SCNT” (or “CNTX”) selection :	4 button
“COLC” (or “SCOL”) selection :	5 button – – – – Color thickness correction
“TNTC” selection :	6 button
Convergence adj :	YELLOW button
Self diagnostic display ON/OFF :	9 button

note: Displayed differently as shown below, depending on the setting of the receiving color system.  
COLP (PAL)  
COLC (NTSC)  
COLS (SECAM)

CAUTION : Never try to perform initialization unless you have changed the memory IC.

#### 4. SELECTING THE ADJUSTING ITEMS

- 1) Every pressing of CHANNEL ▲ button in the service mode changes the adjustment items in the order of table-2. (▼ button for reverse order)

Refer to table-2 for preset data of adjustment mode.  
(See SETTING & ADJUSTING DATA on page 34)

#### 5. ADJUSTING THE DATA

- 1) Pressing of VOLUME ▲/▼ button will change the value of data in the range from 00H to FFH. The variable range depends on the adjusting item.

#### 6. EXIT FROM SERVICE MODE

- 1) Pressing POWER button to turn off the TV once.

#### ■ INITIALIZATION OF MEMORY DATA OF QA02

After replacing QA02, the following initialization is required.

1. Enter the service mode, then select any register item.
2. Press and hold the CALL button on the Remote, then press the CHANNEL ▲ button on the TV. The initialization of QA02 has been completed.
3. Check the picture carefully. If necessary, adjust any adjustment item above.  
Perform "Auto search Memory" on the owner's manual.

CAUTION: Never attempt to initialize the data unless QA02 has been replaced.

#### 7. TEST SIGNAL SELECTION

- 1) Every pressing of -> button on the Remote Control changes the built-in test patterns on screen as described below in SERVICE MODE.

Signal off ———> NTSC signals (5 patterns)  
 ↑ PAL signals (5 patterns) ←

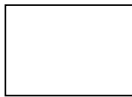
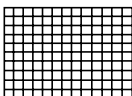
Signals	Picture
<ul style="list-style-type: none"> <li>• Red raster</li> <li>• Green raster</li> <li>• Blue raster</li> <li>• All White</li> </ul>	
<ul style="list-style-type: none"> <li>• Black cross-hatch</li> </ul>	

\* The signals marked with ■ are not usable to display in the Test signal for some model.

### 8. SELF DIAGNOSTIC FUNCTION

- 1) Press "9" button on Remote Control during display of adjustment menu in the service mode.  
The diagnosis will begin to check if interface among IC's are executed properly.
- 2) During diagnosis, the following displays are shown.

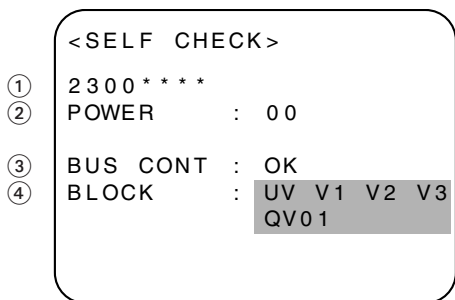

- ① Part number of microcomputer (QA01)
- ② Operation number of protecting circuit ----"00" is normal.  
When indication is other than "00", overcurrent apt to flow, and circuit parts may possibly be damaged.
- ③ BUS CONT ----"OK" is normal.  
When indication shows "Q ○○○ (Green: OK, Red: NG)", the device with the number may possibly be damaged.
- ④ BLOCK  
 UV : TV reception mode  
 V1 : VIDEO 1 input mode (←①)  
 V2 : VIDEO 2 input mode (←②)  
 V3 : VIDEO 3 input mode (←③)

Indicated color of mode now selected : Green and Red  
 Indicated color of other modes : White

Green : Normal

Red : The microcomputer operates to provide judgement of no video signal. The red color is still indicated though the signal is input, failure may exist in input signal line including QV01.

QV01 : In case of indication green ---Normal  
 In case of indication red with input signal----  
 Failure may exist in output line including QV01.

**NOTE:** Component which controls character display on screen is QT01 (TELETEXT IC.). If this display function fails to operate due to damage in QT01, self diagnosis procedure is as follows.

- (1) In case that on timer indicator is blinking with interval of 0.5 seconds; it means protecting circuit (Current limiter) is operating, and circuit components may possibly be damaged. Check related components.

\* The items marked with ■ are not usable to display in the SELF DIAGNOSTIC FUCTION for some model.

# DESIGN MODE

## 1. ENTERING TO DESIGN MODE

- 1) Select the Service mode.
- 2) While pressing CALL button on Remote and press MENU button on TV.
- 3) Press MENU button on TV.

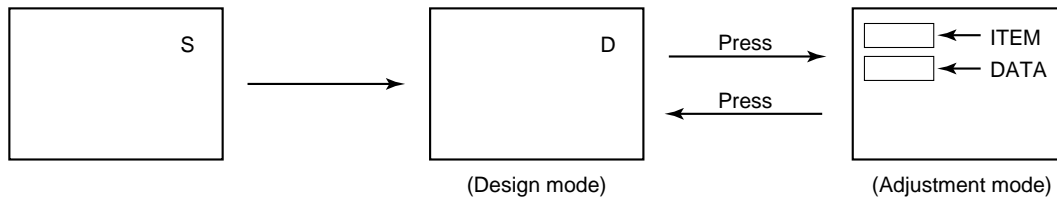

When QA02 is initialized, items “OPT0” and “OPT1” of DESIGN MODE are set to the data of the representative model of this chassis family.

Therefore, because ON-SCREEN specification remains in the state of the representative of model. This model is required to reset the data of items “OPT0” and “OPT1”.

## 2. SELECTING THE ADJUSTING ITEMS

Every pressing of CHANNEL ▼ button in the design mode changes the adjustment items in the order of table-3. (▲ button for reverse order)

Refer to table-3 for data of design mode.  
(See SETTING & ADJUSTING DATA on page 34)

## 3. ADJUSTING THE DATA

Pressing of VOLUME ▲ or ▼ button will change the value of data.

## ELECTRICAL ADJUSTMENT

### PAL

ITEM	ADJUSTMENT PROCEDURE
WIDTH (WID)	<ol style="list-style-type: none"> <li>1. Select picture size WIDE mode.</li> <li>2. Call up the adjustment mode display, and press the TV/VIDEO button on the remote until the white cross dot pattern appears on the screen.</li> <li>3. Press the CHANNEL ▲ or ▼ button to select the item <b>WID</b> and press the VOLUME ▲ or ▼ button to get the picture so the left and right edges of raster begin to lack.</li> <li>4. Press the VOLUME ▲ or ▼ to advance the data 22 steps.</li> </ol> <p>* CAUTION "WID" data don't adjust other picture size, only WIDE mode.</p>
HEIGHT (HIT)	<ol style="list-style-type: none"> <li>1. Call up the adjustment mode display, then select the item <b>HIT</b>.</li> <li>2. Press the VOLUME ▲ or ▼ button to get the picture so the top of raster begins to lack.</li> <li>3. Press the VOLUME ▲ button to advance the data by following steps.                WIDE: 7 steps                Super Live: 11 steps                CINEMA: 10 steps</li> </ol> <p>* CAUTION First adjust WIDE mode next other. Note : Check the vertical picture position is correct.</p>

### NTSC

WIDTH (NWID)	<ol style="list-style-type: none"> <li>1. Select picture size wide mode.</li> <li>2. Call up the adjustment mode display, and press the TV/VIDEO button on the remote until the white cross dot pattern appears on the screen.</li> <li>3. Press the CHANNEL ▲ or ▼ button to select the item <b>WID</b> and press the VOLUME ▲ or ▼ button to get the picture so the left and right edges of raster begin to lack.</li> <li>4. Press the VOLUME ▲ or ▼ to advance the data 16 steps.</li> <li>5. Change picture size Super Live and CINEMA adjust "NWID" data same value for WIDE mode.</li> </ol>
HEIGHT (NHIT)	<ol style="list-style-type: none"> <li>1. Call up the adjustment mode display, then select the item <b>HIT</b>.</li> <li>2. Press the VOLUME ▲ or ▼ button to get the picture so the top of raster begins to lack.</li> <li>3. Press the VOLUME ▲ button to advance the data by following steps.                WIDE: 7 steps                Super Live: 13 steps                CINEMA: 10 steps</li> </ol> <p>Note : Check the vertical picture position is correct.</p>

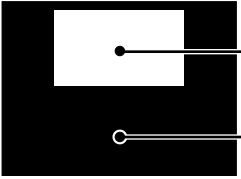
ITEM	ADJUSTMENT PROCEDURE
WHITE BALANCE (RCUT) (GCUT) (BCUT) (RDRV) (BDRV)	<p>Black and White pattern</p>  <p>High light area Adjust "RDRV" or "BDRV" to be white.</p> <p>Low light area Fine adjust "RCUT", "GCUT" or "BCUT" to be black.</p> <ol style="list-style-type: none"> <li>Set user control to reset position. ( CONTRAST → Min. BRIGHTNESS, COLOR, TINT → Center. )</li> <li>Call up the adjustment mode display, then select the item RCUT.</li> <li>Adjust the data of items <b>RCUT</b>, <b>GCUT</b>, and <b>BCUT</b> to "40H".</li> <li>Press the <math>\ominus</math> button on PJTV. (Y-MUTE : ON)</li> <li>Gradually rotate R, G and B screen volume of FOCUS PAC clockwise or counterclockwise until the raster appears slightly on the CRT through the each lens, and leave them. (Lookin to the lens in order to check the raster.)</li> <li>Press the <math>\ominus</math> button on PJTV. (Return to Normal Picture)</li> <li>Press the <math>\ominus</math> button on Remote, and select the Black and White pattern.</li> <li>Adjust the data of items <b>RCUT</b>, <b>GCUT</b> and <b>BCUT</b> for proper white-balanced picture in low light area.</li> <li>Adjust the data of items <b>RDRV</b> and <b>BDRV</b> for proper white-balanced picture in high light area.</li> <li>Check the white balance in both low and high light areas. If necessary, perform again steps from 8 to 9.</li> </ol>

(Reference factory adjustment)

Item	Name	Setting	Input signal	Measuring point	Adjusting method	Adjustment standard
[SCNT]	Sub-contrast	Dynamic mode Audio system: I	Sub-bright signal (PAL-I signal)	TP46B SIGNAL unit	① Adjust the amplitude from the pedestal level to the white peak.	$2.4 \pm 0.1$ Vpp
[BRTC]	Sub-bright center	Dynamic mode	Sub-bright signal	Screen adjustment	① Adjust the number of collapsed black lines of the sub-bright signal. ② Carry out adjustment after adjusting the W/B and SCNT.	$4 \pm 1.5$ linee
[COLP]	Sub-color center PAL	Dynamic mode	Sub-bright signal (PAL)	TP46B SIGNAL unit	① Adjust the amplitude of the color bar. ② Adjust the P-P value of the upper half.	$1.30 \pm 0.1$ Vpp
[BELL]	BELL filter		SECAM color bar	TPM01 SIGNAL unit	① Use a synchroscope and adjust so that the waveforms can become flat. ② Adjust at the white part.	$100 \pm 10$ %
[COLS]	Sub-color center SECAM	Dynamic mode	SECAM color bar	TP46B SIGNAL unit	① Adjust the amplitude of the color bar. (Apply SCREEN mute during adjustment) ② Adjust the P-P value of the upper half.	$1.95 \pm 0.1$ Vop
[SR Y]	SECAM R-Y black level	Dynamic mode	SECAM color bar	TP02 SIGNAL unit	① Adjust so that the level of the monochrome signal part can meet the level of the H,BLK. ② Carry out adjustment after adjusting the BELL.	$0 \pm 10$ mV
[SB Y]	SECAM B-Y black level	Dynamic mode	SECAM color bar	TP01 SIGNAL unit	① Adjust so that the level of the monochrome signal part can meet the level of the H,BLK. ② Carry out adjustment after adjusting the BELL.	$0 \pm 10$ mV



Item	Name	Setting	Input signal	Measuring point	Adjusting method	Adjustment standard
Screen adjustment	Screen	Factory- screen- adjustment mode		CRT screen	<ol style="list-style-type: none"> <li>① Make the surrounding as dark as possible.</li> <li>② Enter factory-screen-adjustment mode. (Y mute, DRV.CUT. = 40 H)</li> <li>③ Directly observe the CRT screen, and adjust the screen VR to the point where it begins to emit light.</li> <li>④ Use R, G, and B tubes respectively to perform above-mentioned adjustments.</li> </ol>	Point where it begins to emit light.
Focus adjustment	Focus	Dynamic mode Cinema mode	Retoma signal (PAL-I)	Crosshatch signal Screen adjustment	<ol style="list-style-type: none"> <li>① Make adjustments to achieve the best possible position by repeating electrical and optical focusing.</li> <li>② Use jigs to protect the CRTs, except the axis under adjustment, from any light.</li> <li>③ Use R, G, and B tubes respectively to perform above-mentioned adjustments.</li> </ol>	For details, refer to the focus adjustment method introduced in the next page.
RDRV BDRV	Bright part W/B			Screen adjustment	① Adjust the color temperature of the bright part (103cd/m <sup>2</sup> ).	8750k-0.002uv
RCUT BCUT	Dark part W/B			Screen adjustment	① Adjust the color temperature of the dark part (17cd/m <sup>2</sup> ).	8750k-0.002uv
High voltage adjustment	High voltage	Dynamic mode	Phillips pattern (PAL-I)	Between T461 and Z450	① Connect a voltmeter between T461 and Z450 and adjust the high voltage with R450. (User adjustment standard)	30.7 ± 0.2kV

## Focus adjustment method (1/2)

Model	Adjustment points	Adjustment methods
40PW03G 40PW03B	<p data-bbox="565 1423 716 1797">Adjustment points</p> <p data-bbox="724 1423 841 1797">Electrical focus</p> <p data-bbox="849 1423 1099 1797">Lens focus  (Precautions)</p>	<p data-bbox="565 149 716 1423"> <b>Conditions:</b>                      (1) RED, BLUE: Internal Retoma signals (PAL)                      (2) GREEN: Internal crosshatch signal (white crosshatch on black background)                      (3) User adjustment: Dynamic mode, cinema mode                      (4) Carry out electrical focus and lens focus after rough adjustment.                      (5) Use the jig to protect everything, except the color subjected to adjustment, from exposure to light.                 </p> <p data-bbox="724 149 841 1423">                     (1) Receive the internal Retoma signals, use the focus VR of the focus pack (Z410), and adjust the electrical focus of each R and B projection tube to the position where the center of the screen gets optimally focused.                      (2) Receive the internal crosshatch signals, use the focus VR of the focus pack (Z410), and adjust the electrical focus of G so that the vertical scanning lines on the screen center can appear most clearly.                 </p> <p data-bbox="849 149 1099 1423">                     (1) R, B: Receive the internal Retoma signals, watch the screen center and its periphery, and make adjustment to the best possible focus.                      (2) G: Adjust this by the method introduced in the next page.                       ① Carry out anticipated adjustment on the G lens, considering the time until the lens focus stabilizes.                      ② The level of anticipated adjustment on the G lens results in a required level of correction, if an adjustment point is set on the screen.                      ③ During a heat run, be sure to keep lower the G's screen VR of the focus pack from turning on the power of the set until immediately before the cutoff adjustment in order to stabilize the G's coupling liquid temperature.                 </p>

## Focus adjustment method (2/2) GREEN lens focus adjustment

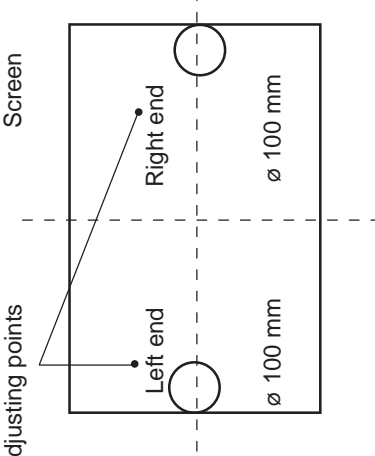
Model	Metodo di regolazione
<p>[1] 40PW03 series</p>  <p>(Point of observation) Inside the circle of 100mm that is in contact with left and right bezels.</p>	<p>(1) Receive internal crosshatch signals, use the lens cap, and concentrate on the single color of G.  (2) Watch the horizon of both the left and right ends on the horizontal axis of the screen, adjust the lens focus of G to the very best, and check that the left-and-right focus balance is appropriate.  (3) Check left-and right balance of G lens focus  ① Use the left (or right) end crosshatch and make the best adjustment on the G's lens focus.  ② Check the right (or left) end focus.  (4) If the left and right lens focus is not properly balanced (tendency for flare), divide and adjust it to the middle grade.  (5) Check on the periphery, and make certain that the focus grade lies within a tolerable level (including flare).</p>

## Completion of adjustment

Item	Name	Setting	Input signal	Measuring point	Adjusting method	Adjustment standard
Screen position adjustment		Dynamic mode	Phillips pattern (PAL-I)	Screen adjustment	(1) Adjust the vertical and horizontal screen positions and centering magnet so that the central + mark of the dummy screen and the + mark of the Phillips pattern can overlap in conformity. Carry this out individually on 3 tubes of R, G, and B (Note) Do not move HPOS, VPOS data	Less than $\varnothing 7\text{mm}$
HIT VLIN	Vertical amplitude adjustment (PAL WIDE)	Dynamic mode WIDE mode	Phillips pattern (PAL-I)	Screen adjustment	(1) Turn the screen size to WIDE. (2) In the first place, shorten the vertical amplitude using HIT data until the upper and lower flags emerge on the screen. (3) Then, extend the vertical amplitude with the HIT data until either upper or lower flag end conforms to the screen end (Adjust the vertical center of the pattern to the central mark of the screen.)	Upper and lower flags are to be in contact
HIT VLIN	Vertical amplitude adjustment (PAL Super-live)	Dynamic mode Super-live mode	Phillips pattern (PAL-I)	Screen adjustment	(1) Turn the screen size to Super-live. (2) Adjust with the HIT so that the top and bottom of the inner circle of Phillips pattern will contact the screen edge. (Note) VLIN adjustment is not performed.	The inner circle is to contact the screen edge
HIT VLIN	Vertical amplitude adjustment (PAL cinema)	Dynamic mode CINEMA mode	Phillips pattern (PAL-I)	Screen adjustment	(1) Turn the screen size to CINEMA. (2) Adjust the registers on the top and bottom of the Phillips pattern as shown in the next page. (Note) Do not touch the centering magnet	

## Completion of adjustment

Item	Name	Setting	Input signal	Measuring point	Adjusting method	Adjustment standard
HIT VLIN	Vertical amplitude adjustment (PAL SUB-TITLE)	Dynamic mode SUB-TITLE mode	Phillips pattern (PAL-I)	Screen adjustment	(1) Turn the screen size to SUB-TITLE. (2) Adjust the registers on the top and bottom of the Phillips pattern as shown in the next page. (Note) Do not touch the centering magnet	
WID	Vertical amplitude adjustment PAL WIDE	Dynamic mode WIDE mode	Phillips pattern (PAL-I)	Screen adjustment	(1) Turn the screen size to WIDE. (2) The left and right flags of the Phillips pattern are to contact the screen edge. (3) The user center position adjustment is to be 0.	
NHIT NLIN	Vertical amplitude adjustment NTSC WIDE	Dynamic mode WIDE mode	Monosco signals NTSC LEADER-435B	Screen adjustment	(1) Turn the screen size to WIDE mode. (2) The 1st line on the screen is to be hidden by the mask.	
NHIT	Vertical amplitude adjustment SUPER-LIVE NTSC	Dynamic mode SUPER-LIVE mode	Monosco signals NTSC LEADER-435B	Screen adjustment	(1) Turn the screen size to SUPER-LIVE mode. (2) Adjust so that the upper side 3rd line on the screen will contact the screen edge. (3) Do not adjust the NVLI.	
NHIT NLIN	Vertical amplitude adjustment CINEMA NTSC	Dynamic mode CINEMA mode	Monosco signals NTSC LEADER-435B	Screen adjustment	(1) Turn the screen size to CINEMA mode. (2) Adjust so that the character 30 on the upper, lower, and left-and-right ends will contact the screen edge.	
NHIT NLIN	Vertical amplitude adjustment SUB-TITLE NTSC	Dynamic mode SUB-TITLE mode	Monosco signals NTSC LEADER-435B	Screen adjustment	(1) Turn the screen size to SUB-TITLE mode. (2) Adjust so that the upper side 5th line of the register on the screen will contact the screen. (3) The NVLI is not to be adjusted.	

### Completion of adjustment

Item	Name	Setting	Input signal	Measuring point	Adjusting method	Adjustment standard
NWIDE	Horizontal amplitude adjustment WIDE NTSC	Dynamic mode WIDE mode	Monosco signals NTSC LEADER-435B	Screen adjustment	(1) Turn the screen size to WIDE. (2) Adjust the 2nd left register to the left edge of the screen. (3) When you change the NWID value on the WIDE screen also input the identical data to SUPER-LIVE and CINEMA.	

### Unit adjustment DIGITAL-CONVER

Item	Name	Setting	Input signal	Measuring point	Adjusting method	Adjustment standard
PLL Frequency adjustment				Q709 Emitter	(1) Apply +5V to #15, #16 terminals +9V to #13 terminal -9V to #14 terminal. (2) Adjust emitter's frequency to Q709 with L719.	32 ± 0.1 MHz

# CONVERGENCE ADJUSTMENT

## 1. Screen Adjustment

The four PAL screens Wide/4:3, Super Live, Cinema and Subtitle, and the four NTSC screens Wide/4:3, Super Live, Cinema and Subtitle are adjusted. When adjusting, input an external signal for matching the sync.

**CAUTION:** The convergence circuit eliminates screen distortion but cannot make large corrections such as changing the overall screen size. Use caution because the protection circuit will be activated if corrections are excessively large. Before starting to adjust the various screens, always adjust the vertical size (HIT) and horizontal size (WID) by changing the main deflection data.

Execute the adjustment screens in the sequence Wide/4:3 → Super Live → Cinema → Subtitle for both PAL and NTSC.

### 1-1. Entering Adjustmet Menu

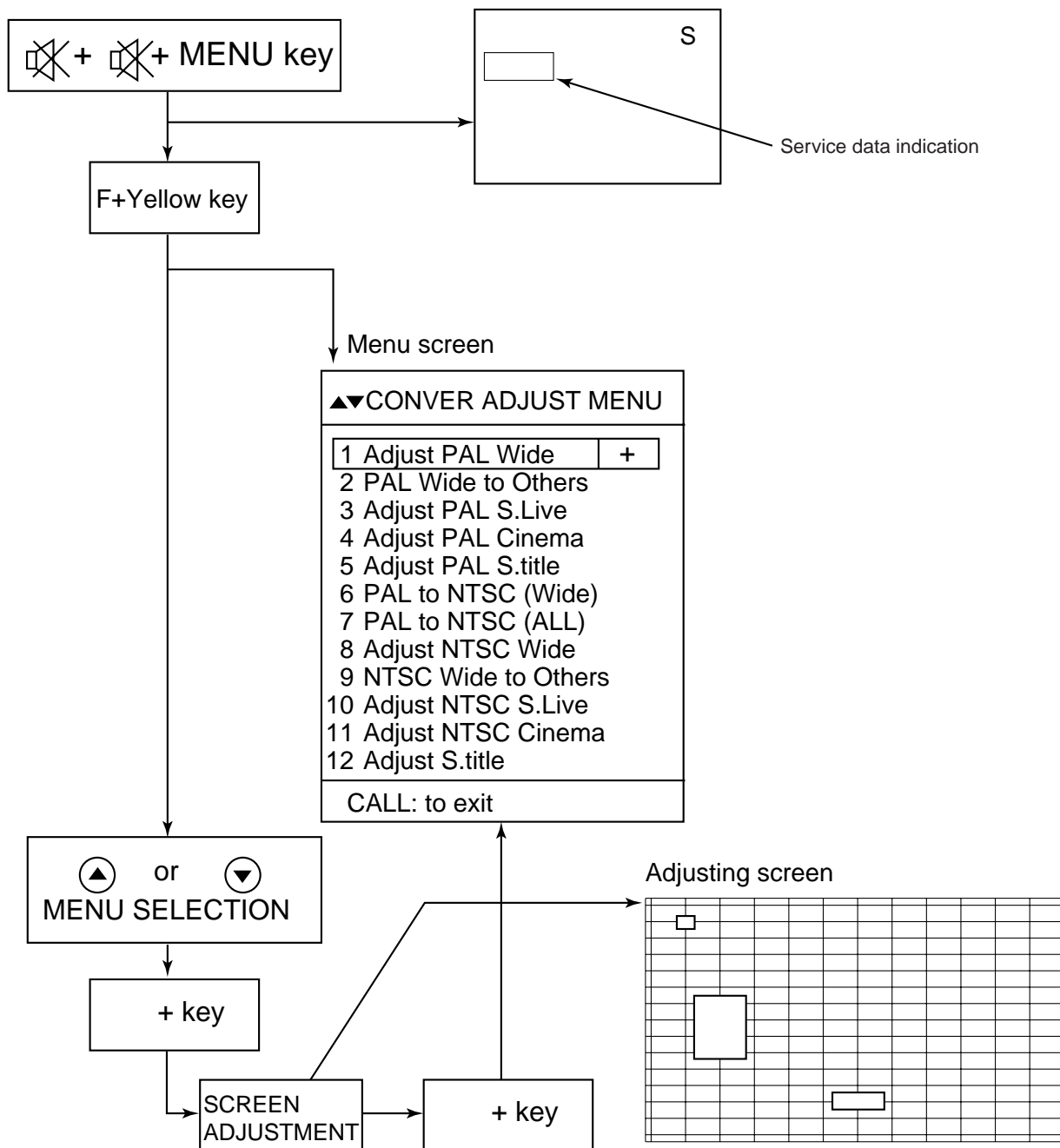

1-2. Remote Control Key

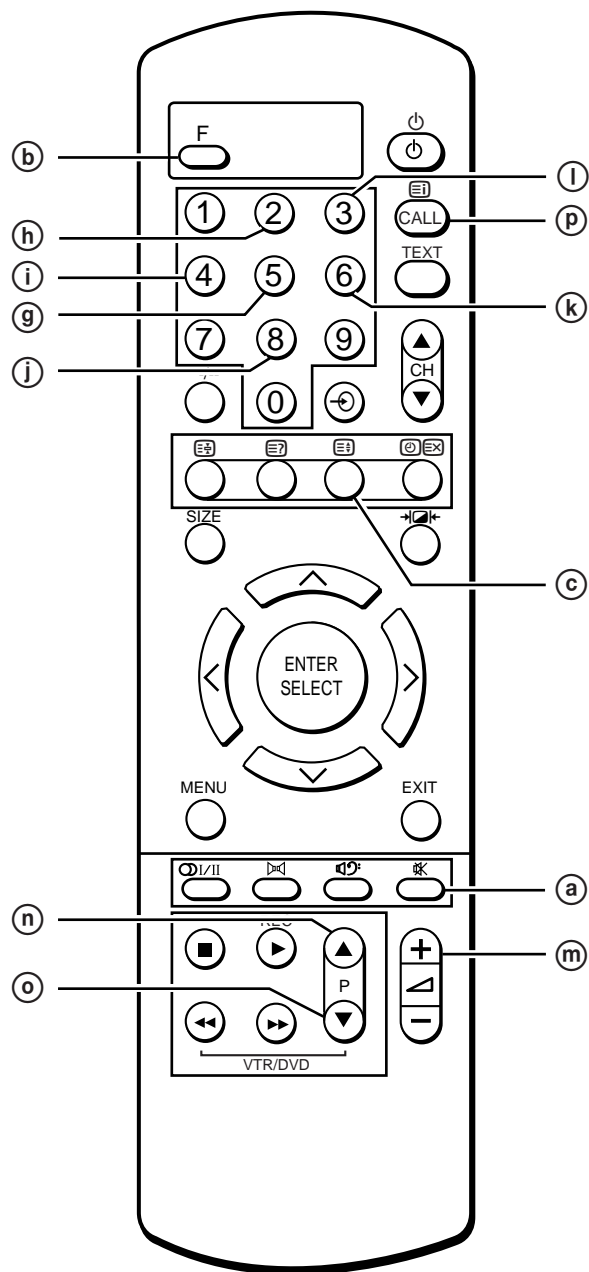

- (a) key ..... Push this key twice and the set console menu key to enter the service mode.
- (b) F key ..... Push this key and yellow key to enter the convergence menu.
- (c) Yellow or 7 key .. Convergence menu key.
- (g) 5 key ..... Cursor shift / data change mode change-over.
- (h) 2 key ..... Cursor up / adjusting point up.
- (i) 4 key ..... Cursor left / adjusting point left
- (j) 8 key ..... Cursor down / adjusting point down
- (k) 6 key ..... Cursor right / adjusting point right
- (l) 3 key ..... Cursor colour change (Adjusting colour selection).
- (m) + key ..... Execution key on convergence menu.
- (n) key ..... Up key on convergence menu.
- (o) key ..... Down key on convergence menu.
- (p) CALL key ..... Termination key on convergence menu.

Fig. 2



### 1-3. Adjusting Screen

#### 1) Adjusting menu

NO	Item	Description
1	Adjust PAL Wide	Used for manual adjustment of the Wide/4:3 screen in the PAL mode. Returns to the original screen data screen before data conversion, explained below.
2	PAL Wide to others	Automatically saves approximate supplementary data for the other PAL screens based on the PAL Wide/4:3 screen data. First, the PAL Wide/4:3 screen data are converted to Super Live and the values are saved. Next, the data are converted to Cinema and the values are saved. Finally, the data are converted to Subtitle and the values are saved, and then the operation ends. Manually check the other screen modes as described below and make corrections if distortion, etc., is present.  Please be aware that all PAL screens are re-adjusted when this menu is selected and executed.
3	Adjust PAL S.Live	Used for manual adjustment of the PAL Super Live screen. Select this mode for Super Live screen color matching and distortion adjustment. Use the specified dimensions when adjusting.
4	Adjust PAL Cinema	Used for manual adjustment of the PAL Cinema screen. Select this mode for Cinema screen color matching and distortion adjustment. Use the specified dimensions when adjusting.
5	Adjust PAL S.title	Used for manual adjustment of the PAL S.title screen. Select this mode for S.title screen color matching and distortion adjustment. Use the specified dimensions when adjusting.
6	PAL to NTSC (Wide)	PAL Wide/4:3 screen data is calculated, converted to NTSC Wide/4:3 approximate data and saved. To assure accurate adjustments, select the manual mode explained below and check, then apply color matching and distortion adjustments.
7	PAL to NTSC (All)	Data for all PAL screens is converted to approximate data for the NTSC screens and saved. To assure accurate adjustments, select the manual mode explained below and check, then apply color matching and distortion adjustments.
8	Adjust NTSC Wide	Used for manual adjustment of the NTSC Wide/4:3 screen. Select this mode for Wide/4:3 screen color matching and distortion adjustment. Use the specified dimensions when adjusting.
9	NTSC Wide to others	Approximate supplementary data for the other NTSC screens is automatically saved based on the NTSC Wide/4:3 screen data. First, the NTSC Wide/4:3 screen data are converted to Super Live and the values are saved. Next, the data are converted to Cinema and the values are saved. Finally, the data are converted to Subtitle and the values are saved, and then the operation ends. Manually check the other screen modes as described below and make corrections if distortion, etc., is present.  Please be aware that all NTSC screens are re-adjusted when this menu is selected and executed.

NO	Item	Description
10	Adjust NTSC S.Live	Used for manual adjustment of the NTSC Super Live screen. Select this mode for Super Live screen color matching and distortion adjustment. Use the specified dimensions when adjusting.
11	Adjust NTSC Cinema	Used for manual adjustment of the NTSC Cinema screen. Select this mode for Cinema screen color matching and distortion adjustment. Use the specified dimensions when adjusting.
12	Adjust NTSC S.title	Used for manual adjustment of the NTSC Subtitle screen. Select this mode for Subtitle screen color matching and distortion adjustment. Use the specified dimensions when adjusting.

2) Adjustment Screen

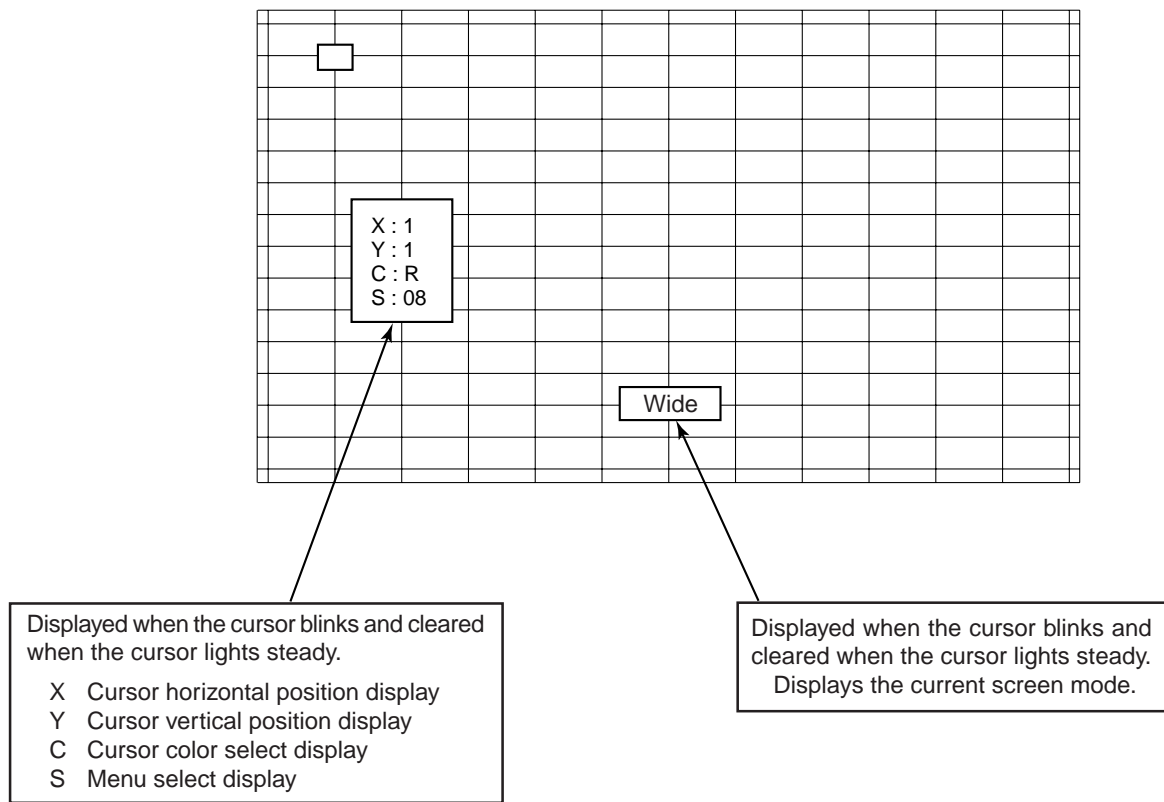

3) Adjustment Sequence

When the initial screen opens, X = 1, Y = 1, C = R and S = [Select Menu] are displayed as the defaults. The cursor can now be moved up, down, left and right using the (2), (8), (4) and (6) keys of the remote control. Select the desired adjustment and press the (5) key; the cursor will light steady and the screen display will be cleared. Again press the (2), (8), (4) and (6) keys of the remote control to adjust the shape of the screen. When adjustment has been completed, press the (+) key to return to the Adjustment Menu. When all of the screen adjustments have been completed, turn off the main power supply of the set to reset the menu.

## 2. Case Study

In many cases, color matching problems can be solved by returning the HIT and WID data for main deflection to the initial adjustment values. Convergence cannot be re-adjusted in the following cases.

### 2-1 When the CRT has been replaced

Main deflection re-adjustment and color matching are necessary when the CRT has been replaced. Use the following procedure.

1. Replace the blue and red CRTs.
2. Perform the blue and red yoke horizontal adjustments in relation to the green CRT. Press the yokes and speed modulation coils + alignments onto the CRTs and fasten after making sure that there are no gaps.
3. Adjust the blue and red alignments (refer to the detailed alignment adjustment item).
4. Use centering magnets to center the blue and red CRTs in relation to the green CRT.
5. Adjust the main deflection HIT and WID data, using the most accurate location in relation to the green as data.
6. Use convergence to match the colors for each screen. Green will not work at this time.
7. When the convergence adjustments have been completed for all screens, then replace the green CRT.

Repeat the procedures in steps 2 - 5 for the green CRT but this time use convergence to match the colors using red and blue as reference.

### 2-2 When replacing the convergence unit

Generally, all of the screens must be re-adjusted when the convergence unit is replaced, but the process can be greatly shortened by using the following method.

1. Replace the memory (Q711, Q712, Q713) of the new unit with the memory (Q711, Q712, Q713) of the defective unit. This makes it possible to quickly reproduce the previous screen status when installed in the set.
2. Install the new unit with the old memory in the set and turn on the power. The entire screen will move linearly in either the vertical or horizontal direction.
3. Use centering magnets to re-adjust the green, red and blue centers.
4. There is possibility of color mismatching or differences in screen size when the various screens are checked. In such case, adjust the main deflection and apply a slight amount of convergence color matching.

### 2-3 When none of the above cases apply (rare case)

An unexpected situation or major operational error, etc., could be considered but it is recommended that all screens be matched starting from the beginning. If the initial positions of the centering magnets are unknown, disconnect the connectors for the convergence sub-yoke outputs one at a time, adjust the CRT centering and then start the following adjustments.

1. Make sure that there is plenty of room for the static cross convergence to be moved left, right, up and down. If sufficient space is not available, move to an appropriate location and then re-adjust the centering.
2. Enter the convergence adjustment mode and call out the menu. (Leave the PAL signal connected.)
3. Select 1. Adjust PAL Wide and adjust the PAL mode Wide/4:3 screen manually in accordance with the dimension diagram.
4. When the Wide/4:3 screen adjustment has been completed, return to the Main Menu and select 2. PAL Wide to others.  
The screen will change automatically and the Wide, Cinema and Subtitle screens will be created automatically.
5. Next, select 3. Adjust PAL S.Live and mainly adjust in the horizontal direction in accordance with the dimension diagram.
6. Next, select 4. Adjust PAL Cinema and fine adjust to remove any Cinema screen distortion.
7. Next, select 5. Adjust PAL Subtitle and fine adjust to remove any Subtitle screen distortion.
8. Next, select 7. PAL to NTSC (ALL), then calculate and copy the data for all PAL screens in the NTSC mode. At this time, the calculations and screen shape changes will be performed automatically and the NTSC screen data corresponding to the PAL screens will be transferred.
9. Select in sequence 8. Adjust NTSC Wide, 10. Adjust NTSC S.Live, 11. Adjust NTSC Cinema and 12. Adjust NTSC Subtitle, check the respective NTSC screen modes and, if necessary, adjust for any distortion.

All of the screens can be adjusted with the above process but make every effort not to change the factory data unless absolutely necessary. Try not to change the convergence data any more than necessary.

### 3 Screen adjustment dimensions

#### 3-1 WIDE/4:3 (PAL mode)

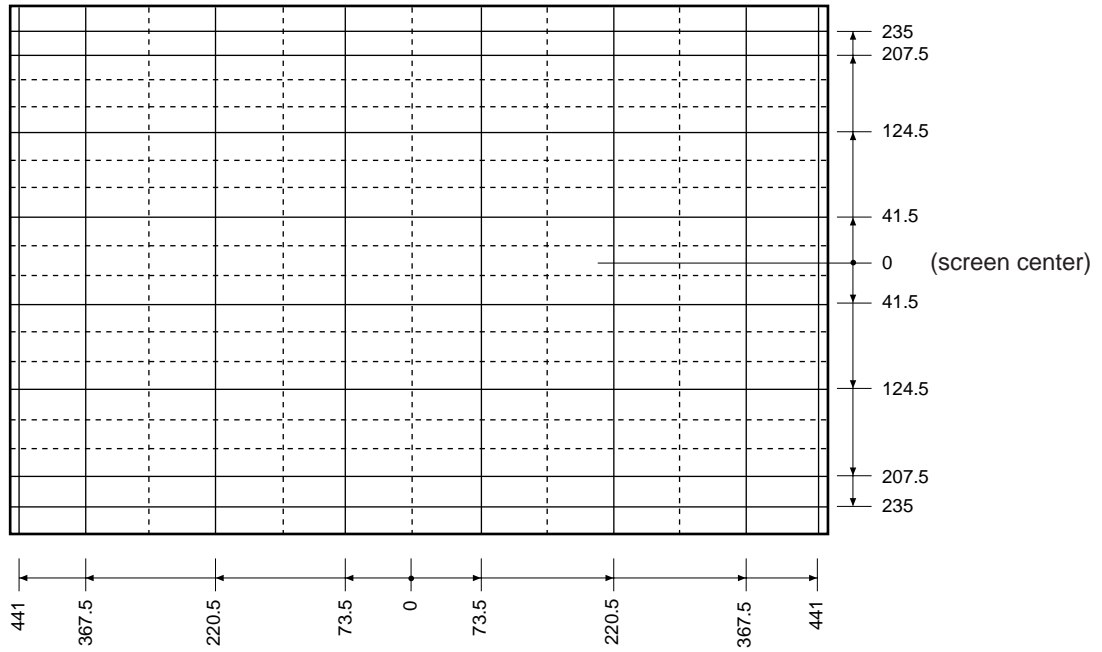

#### 3-2 Super Wide (PAL mode)

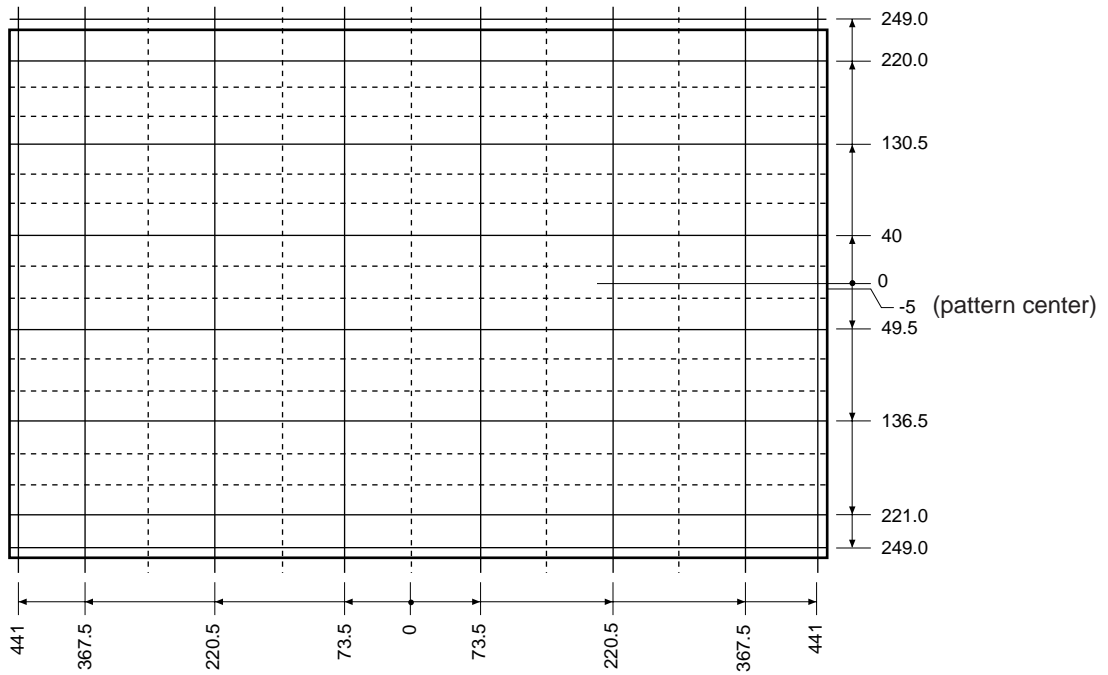

Caution: Do not perform the VLIN adjustment.

### 3-3 Cinema (PAL mode)

Note: The cursor will move outside the screen limits in the Cinema mode; therefore, be careful to consider the position of the cursor displayed on the screen when making adjustments.

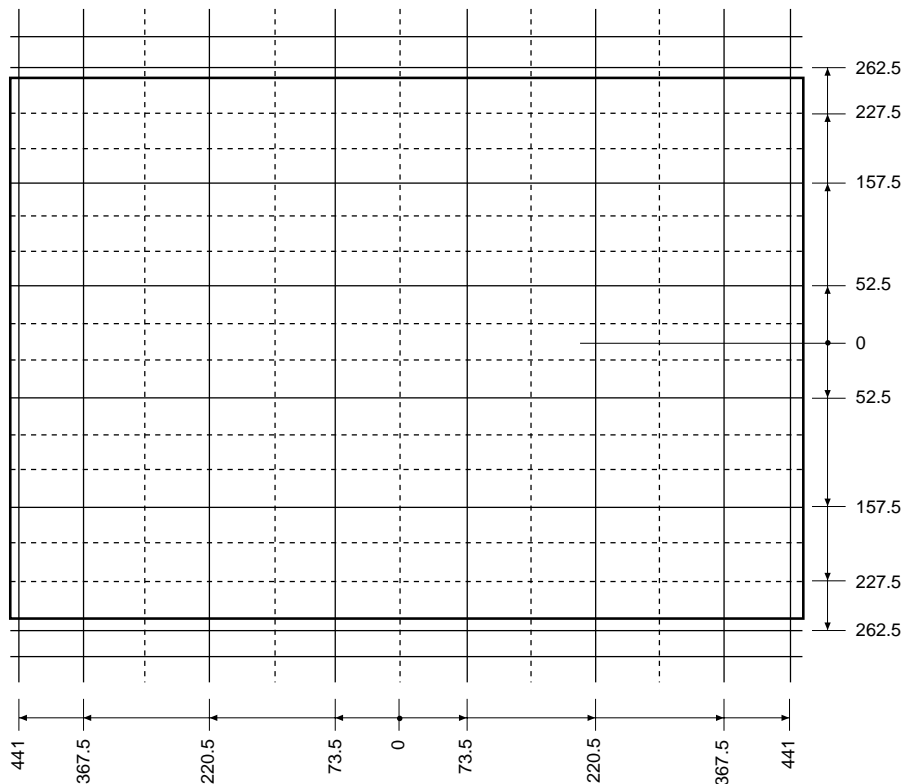

### 3-4 Subtitle (PAL mode)

Note: The cursor will move outside the screen limits in the Subtitle mode; therefore, be careful to consider the position of the cursor displayed on the screen when making adjustments.

Note: Please be aware that the Subtitle screen convergence pattern center is located at the center of the screen but the image center is located approximately 13mm above that.

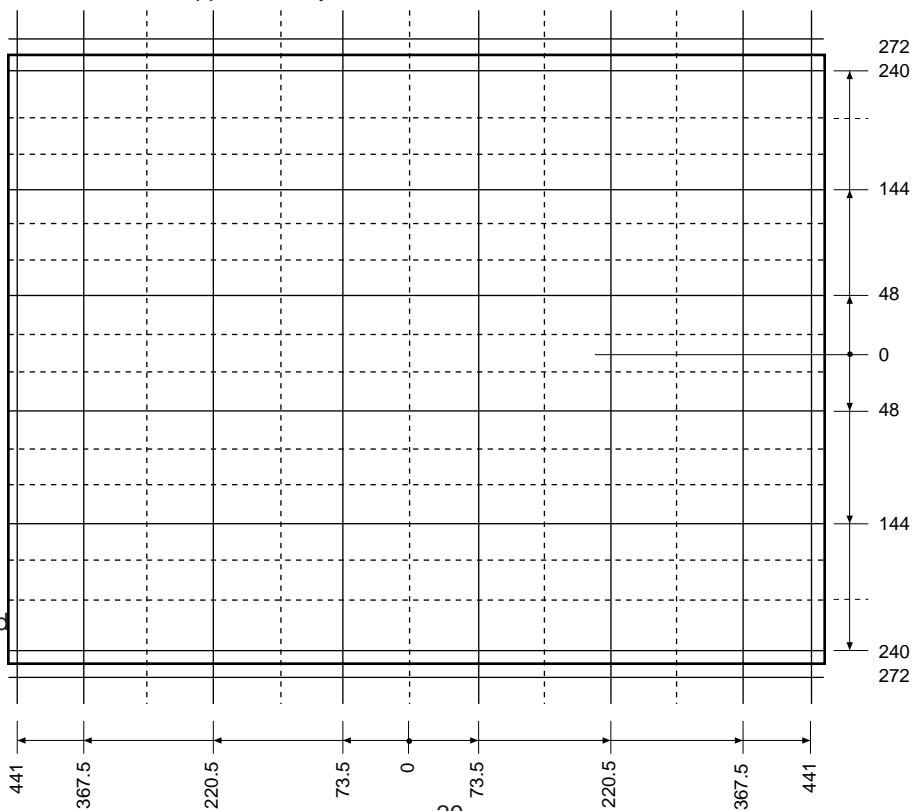

3-5 WIDE/4:3 (NTSC mode)

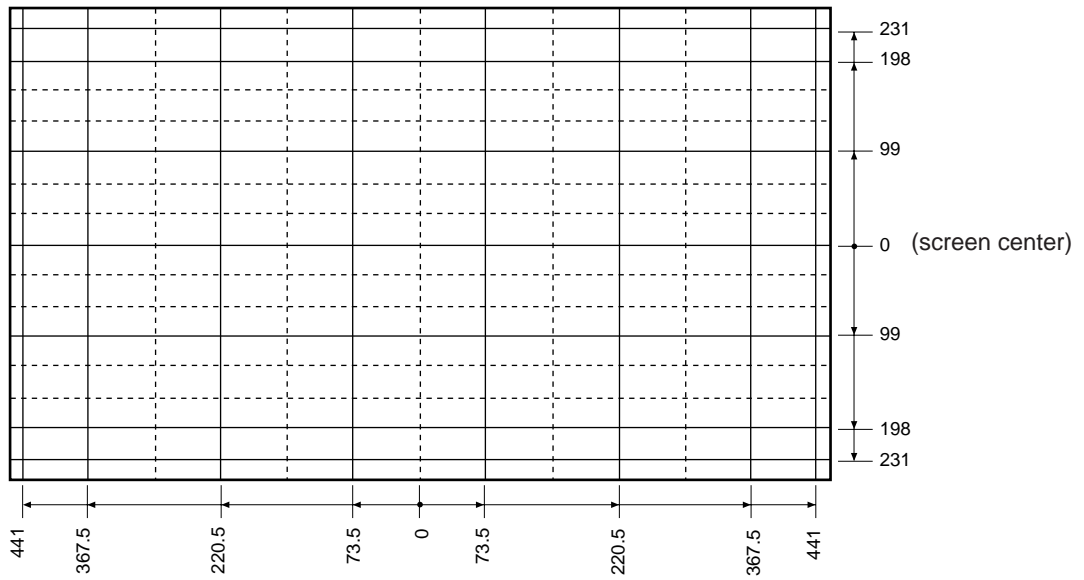

3-6 Super Live (NTSC mode)

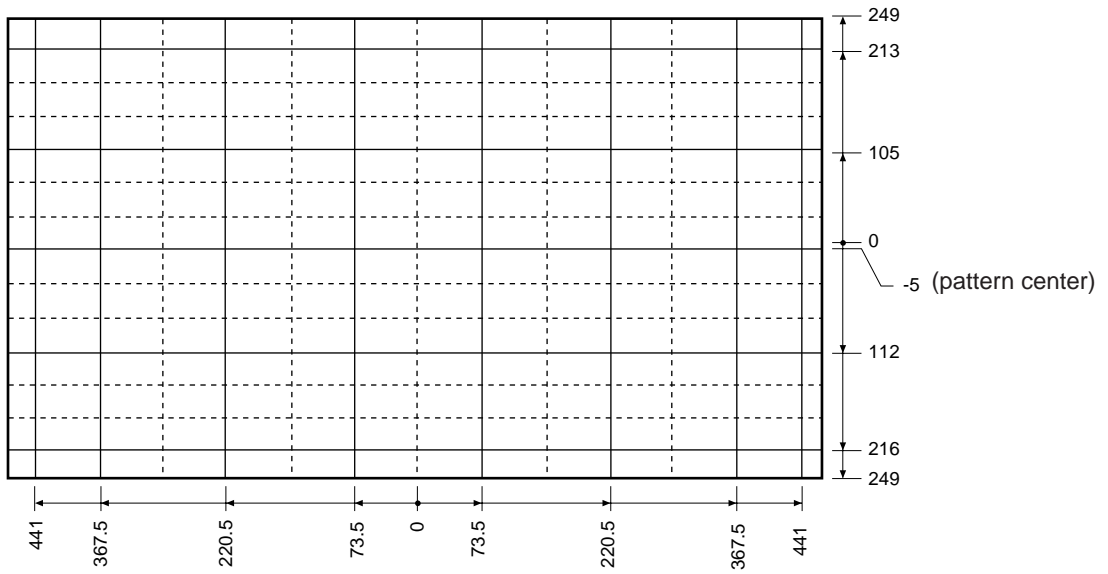

Caution: Do not perform the VLIN adjustment.

**3-7 Cinema (NTSC mode)**

Note: The cursor will move outside the screen limits in the Cinema mode; therefore, be careful to consider the position of the cursor displayed on the screen when making adjustments.

Note: Please be aware that the Cinema screen convergence pattern center is located at the center of the screen but the image center is located approximately 13mm above that.

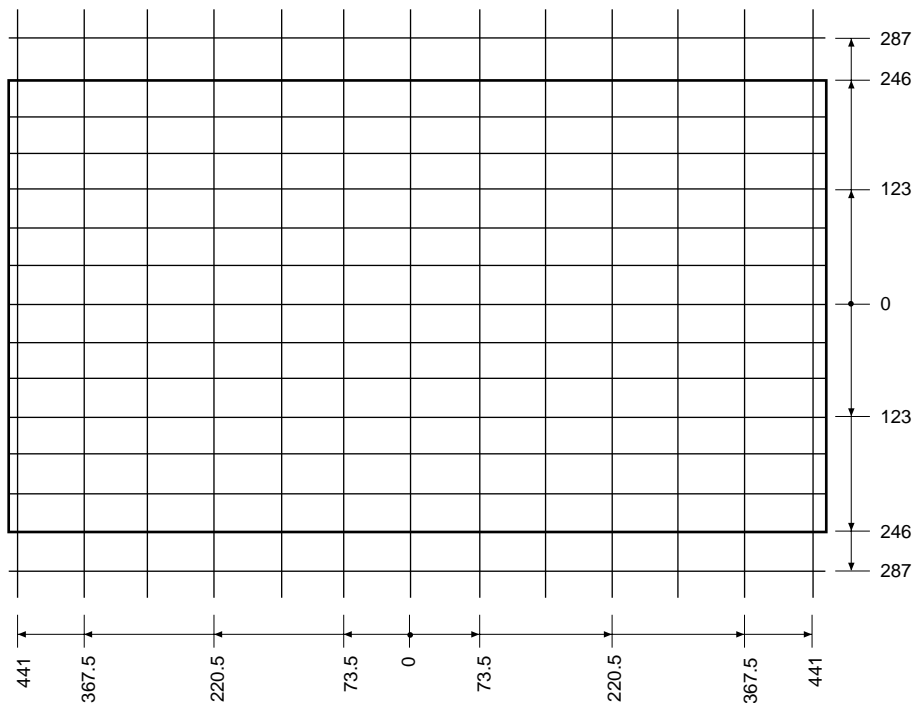

**3-8 Subtitle (NTSC mode)**

Note: The cursor will move outside the screen limits in the Subtitle mode; therefore, be careful to consider the position of the cursor displayed on the screen when making adjustments.

Note: Please be aware that the Subtitle screen convergence pattern center is located at the center of the screen but the image center is located approximately 32mm above that.

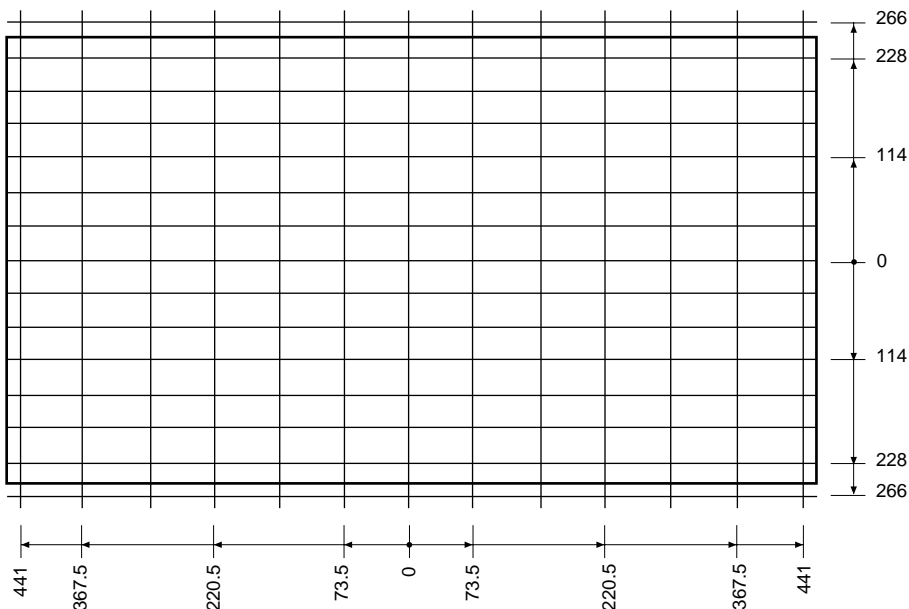

# SCREEN AND MIRROR ALIGNMENTS

## ASSEMBLING AND MOUNTING OF FRONT SCREEN

\* Please refer to MECHANICAL DISASSEMBLY page.38.

### CLEANING OF LENS AND MIRROR

**CAUTION :** Do not hold the optical system parts (lens and mirror) with bare hand to avoid finger-prints on the surface of those parts.

#### HOW TO CLEAN LENS AND MIRROR

1. Be sure to remove sand dust with an air brush, etc.
2. When it is stained slightly, breathe upon it and wipe away with the specified cleaning cloth.  
For other stains than the above, wipe the stains away with the specified cloth into which a cleaning liquid has been soaked.

Cleaning liquid ..... **LENS LUSTER** (Manufactured by Edmund Scientific Co.), etc.

#### HOW TO CLEAN SCREEN

When cleaning the screen, use a soft cloth so as not to damage the screen.

1. Wipe the stain away with a diluted neutral detergent soaked cloth.
2. Wipe the detergent away with a water soaked cloth.
3. Wipe the screen with a dry cloth to remove moisture on the screen.

**Note :** Absolutely do not use alcohol, benzine, thinner, etc. for cleaning in order not to wipe away the black print on the surface.



## CIRCUIT CHECKS

### HIGH VOLTAGE CHECK

**CAUTION:** There is no HIGH VOLTAGE ADJUSTMENT on this chassis. Checking should be done following the steps below.

1. Connect an accurate high voltage meter to the anode of the picture tube.
2. Turn on the receiver. Set the BRIGHTNESS and CONTRAST to minimum (zero beam current).
3. High voltage must be measured below (B) kV.

Refer to table-1 for high voltage (B).  
(See SETTING & ADJUSTING DATA on page 34)

4. Vary the BRIGHTNESS to both extremes to be sure the high voltage does not exceed the limit under any conditions.

### CAUTION:

When the following parts fail, check the High Voltage after replacing.

Location No.	Name	Name
T461	Flyback Trans.	TFB3078BD
D489	Zener Diode	MTZJ3.6B
Q480	Transistor	2SC2023
Q483	IC	TA7508P(J)
R435	Resistor	33k ohm, $\pm 5\%$
R489	Resistor	3.3k ohm, $\pm 5\%$
R490	Resistor	3.3k ohm, $\pm 5\%$
R450	VR	1k ohm
C440	Capacitor	1000pF, $\pm 3\%$
C443	Capacitor	6800pF, $\pm 3\%$
C444	Capacitor	5100pF, $\pm 3\%$

### ANODE VOLTAGE MEASURING METHOD

**CAUTION:** Take extra precaution when measuring this high voltage. High voltages are also present in surrounding circuit boards (CRT DRIVE assembly, DEFLECTION assembly, and POWER SUPPLY assembly).

1. Disconnect the FBT anode cable as outlined below. Measure high voltage at the point where the cable enters the FBT.
2. Holding the rubber cover firmly, turn it counterclockwise and check that the lock has been disengaged. (See Fig. b on page 8.)
3. Determine the extent of the rubber cover before disconnecting the cable.
4. Pull straight up the anode cable to disconnect.
5. When reconnecting the cable, proceed in the reverse order.  
After reconnecting, tug on the cable to check that it is secure.

## CHAPTER 2 SPECIFIC INFORMATIONS

### SETTING & ADJUSTING DATA

#### 【 SAFETY INSTRUCTIONS 】

		40"
HIGH VOLTAGE AT ZERO BEAM:	(A)	31.9 kV
MAX HIGH VOLTAGE:	(B)	32.5 kV
AV VOLTAGE	(C)	230 V

Table-1

#### 【 SERVICE MODE 】

##### ADJUSTING ITEMS AND DATAS IN THE SERVICE MODE:

Item	Adjustment	Reference data	Item	Adjustment	Reference data
RCUT	R CUTOFF (B/W)	40H	HPOS	50Hz H-POSITION	0CH
GCUT	G CUTOFF (B/W)	40H	VPOS	V-POSITION	01H
BCUT	B CUTOFF (B/W)	40H	HIT	HEIGHT	26H
RDRV	R DRIVE	40H	GMPS	V-POSITION (RASTER)	00H
BDRV	B DRIVE	40H	VLIN	V-LINEARITY	15H
CNTX	SUB CONTRAST MAX	7FH	VSC	V-S CORRECTION	26H
BRTC	SUB BRIGHT CEN	80H	VPS	V-SHIFT	12H
COLC	SUB COLOR CEN NTSC	FDH	VCP	V-COMPENSATION	05H
TNTC	SUB TINT CEN	45H	WID	PICTURE WIDTH	1EH
COLP	SUB COLOR CEN PAL	50H	PARA	E-W PARABOLA	02H
COLS	SUB COLOR CEN SECAM	38H	CNR	E-W CORNER	10H
SCNT	SUB CONTRAST	07H	TRAP	TRAPEZIUM	40H
BELL	SECAM BELL FILTER	80H	HCP	H-COMPENSATION	04H
SRY	SECAM R-Y	08H	VFC	V-F CORRECTION	0FH
SBY	SECAM B-Y	08H			

Table-2

#### 【 DESIGN MODE 】

##### ADJUSTING ITEMS AND DATAS IN THE DESIGN MODE:

Item	Name of adjustment	Preset Data	40PW03G	40PW03B	Remarks
RCUT					
OPT1	OPTION 1	4CH	4CH	4CH	
OPT0	OPTION 0	80H	80H	81H	
OSD					
.					
.					
.					
RCUT					

Table-3

# LOCATION OF CONTROLS

Front

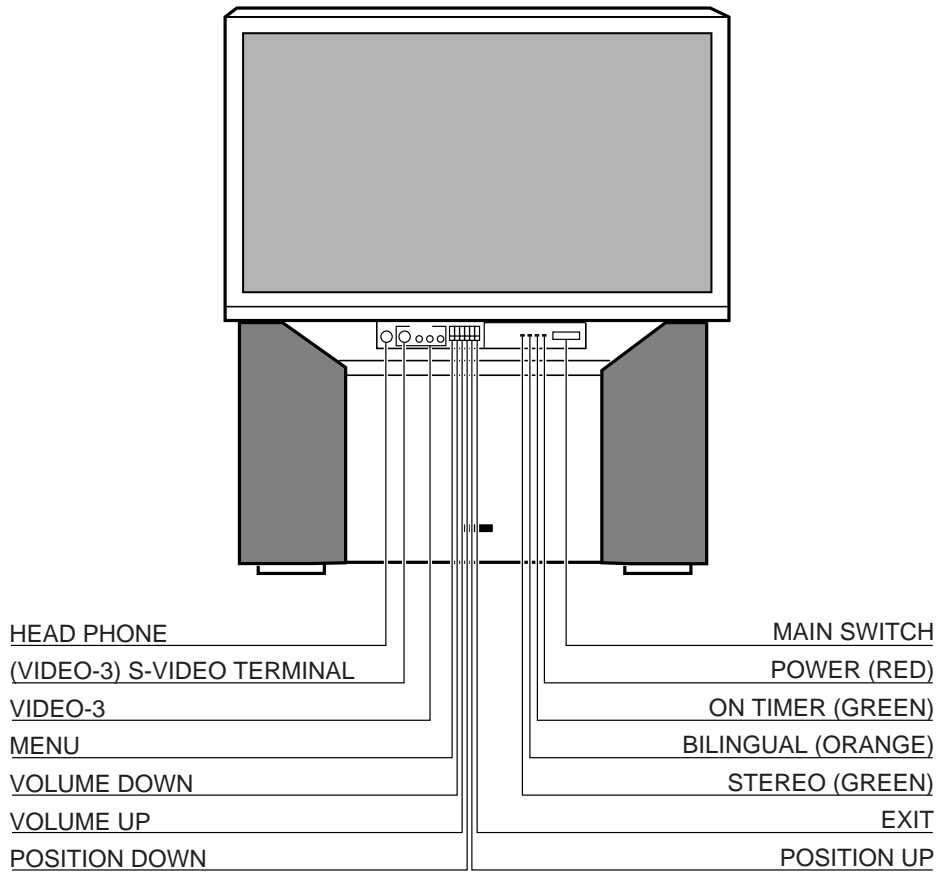

Back

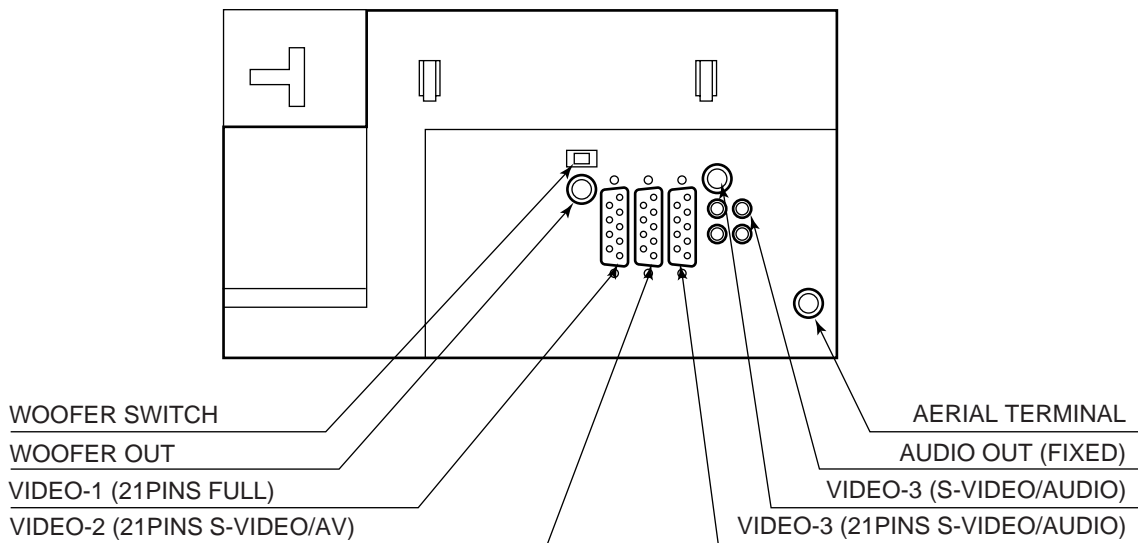

# Remote Controller

SPECIFIC INFORMATIONS

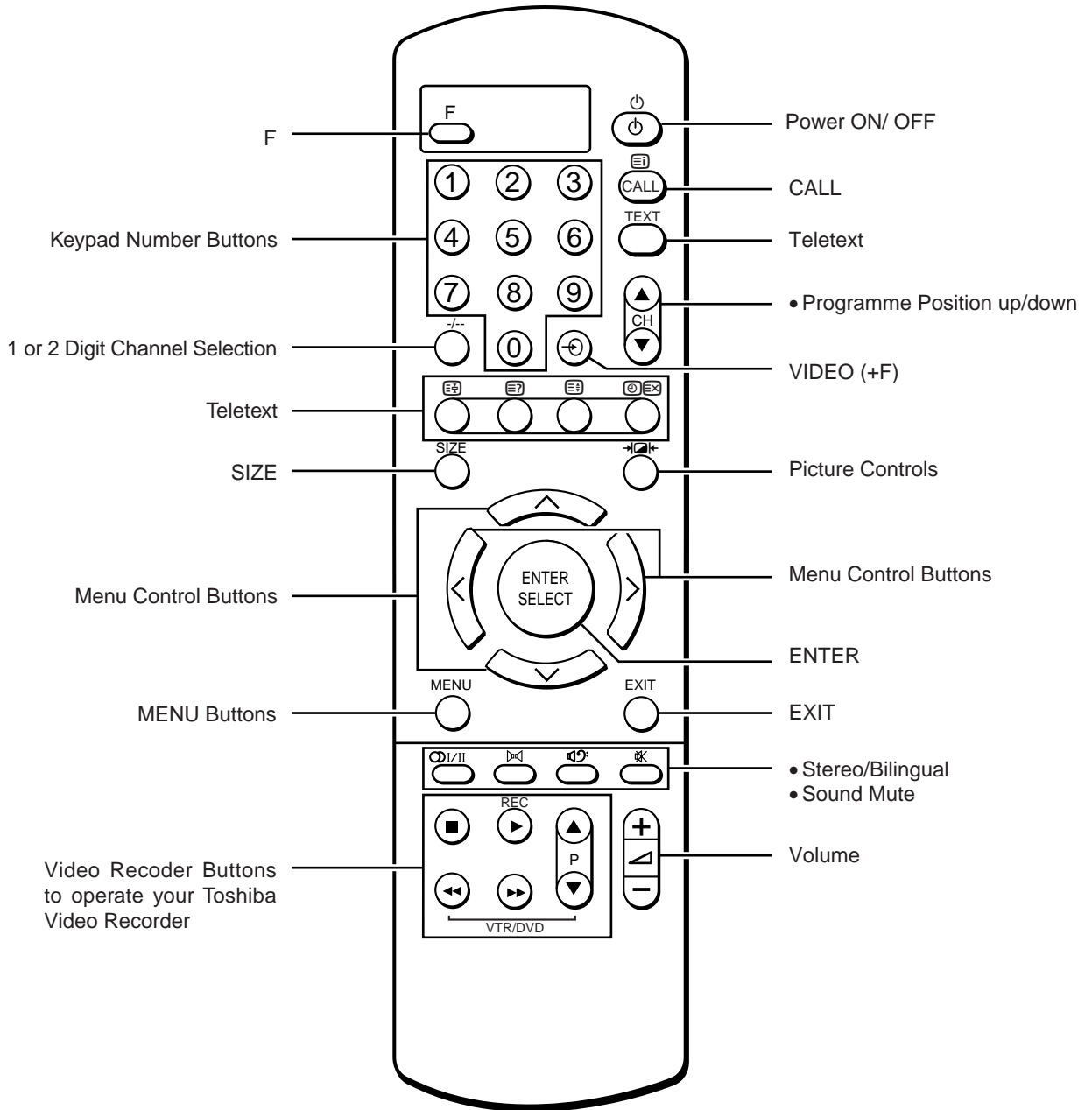

# CIRCUIT BLOCK DIAGRAM

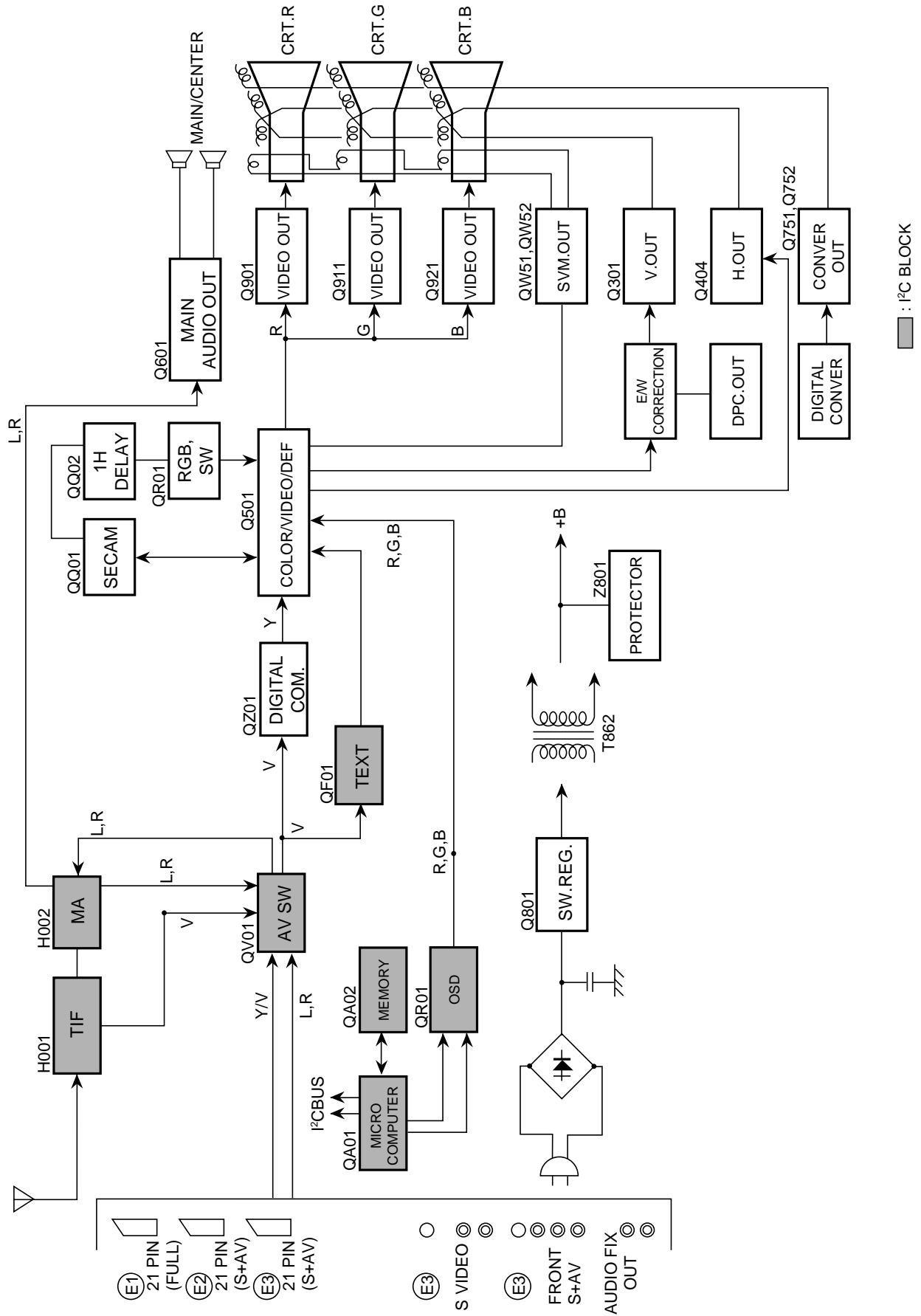

# MECHANICAL DISASSEMBLY

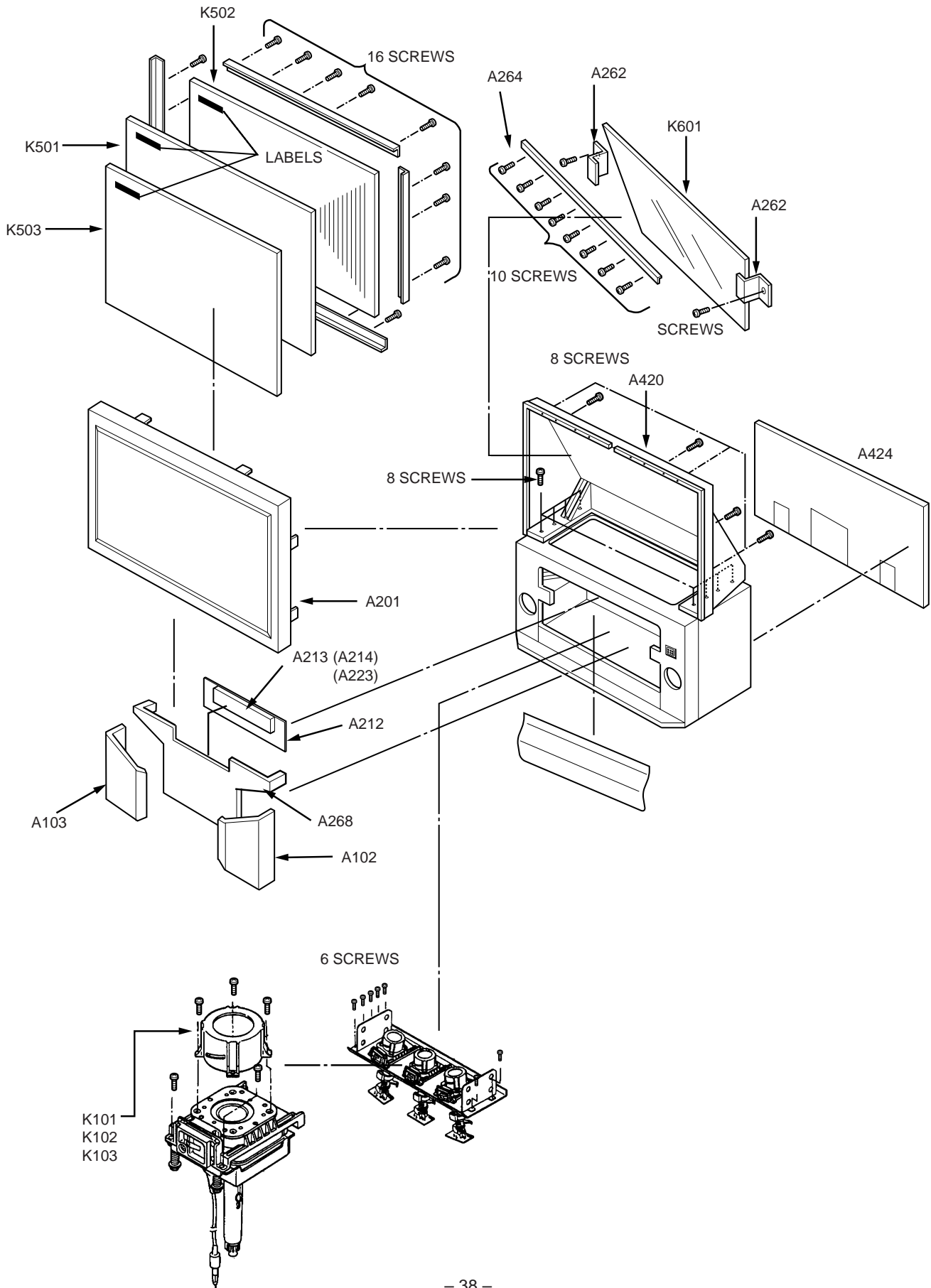

SPECIFIC INFORMATIONS

# CHASSIS AND CABINET REPLACEMENT PARTS LIST

**WARNING:** BEFORE SERVICING THIS CHASSIS, READ THE "X-RAY RADIATION PRECAUTION", "SAFETY PRECAUTION" AND "PRODUCT SAFETY NOTICE" ON PAGE 3 OF THIS MANUAL.

**CAUTION:** The international hazard symbols " $\triangle$ " in the schematic diagram and the parts list designate components which have special characteristics important for safety and should be replaced only with types identical to those in the original circuit or specified in the parts list. The mounting position of replacements is to be identical with originals. Before replacing any of these components, read carefully the PRODUCT SAFETY NOTICE. Do not degrade the safety of the receiver through improper servicing.

**NOTICE:**

- The part number must be used when ordering parts, in order to assist in processing, be sure to include the Model number and Description.
- The PC board assembly with \* mark is no longer available after the end of the production.

**ABBREVIATIONS:**

Capacitors ..... CD : Ceramic Disk      PF : Plastic Film      EL : Electrolytic  
 Resistors ..... CF : Carbon Film      CC : Carbon Composition      MF : Metal Film  
                          OMF : Oxide Metal Film      VR : Variable Resistor      FR : Fusible Resistor  
 (All CD and PF capacitors are  $\pm 5\%$ , 50V and all resistors,  $\pm 5\%$ , 1/6W unless otherwise noted.)

**Models : 40PW03G, 40PW03B**

Location No.	Part No.	Description	Location No.	Part No.	Description
<b>CAPACITORS</b>			C308	24669221	EL, 220 $\mu$ F, $\pm 20\%$ , 50V
C101	24793220	EL, 22 $\mu$ F, $\pm 20\%$ , 10V	C309	24212101	CD, 100pF, $\pm 10\%$
C102	24762221	EL, 220 $\mu$ F, $\pm 20\%$ , 10V	C310	24669222	EL, 2200 $\mu$ F, $\pm 20\%$ , 50V
C105	24212102	CD, 1000pF, $\pm 10\%$	C311	24214561	CD, 560pF, $\pm 10\%$ , 500V
C106	24797100	EL, 10 $\mu$ F, $\pm 20\%$ , 50V	C313	24082057	PF, 0.22 $\mu$ F, 100V
C115	24232103	CD, 0.01 $\mu$ F, +80%, -20%	C314	24591103	PF, 0.01 $\mu$ F
C116	24762221	EL, 220 $\mu$ F, $\pm 20\%$ , 10V	C315	24797229	EL, 2.2 $\mu$ F, $\pm 20\%$ , 50V
C150	24763102	EL, 1000 $\mu$ F, $\pm 20\%$ , 16V	C316	24232103	CD, 0.01 $\mu$ F, +80%, -20%
C183	24766479	EL, 4.7 $\mu$ F, $\pm 20\%$ , 50V	C318	24666222	EL, 2200 $\mu$ F, $\pm 20\%$ , 16V
C194	24232103	CD, 0.01 $\mu$ F, +80%, -20%	C319	24591102	PF, 1000pF
C201	24538104	PF, 0.1 $\mu$ F	C320	24669101	EL, 100 $\mu$ F, $\pm 20\%$ , 50V
C202	24814103	Chip, 0.01 $\mu$ F, +80%, -20%	C321	24591183	PF, 0.018 $\mu$ F
C203	24538104	PF, 0.1 $\mu$ F	C322	24617915	EL, 1 $\mu$ F, $\pm 10\%$ , 50V
C204	24669010	EL, 1 $\mu$ F, $\pm 20\%$ , 50V	C323	24567474	PF, 0.47 $\mu$ F
C205	24669229	EL, 2.2 $\mu$ F, $\pm 20\%$ , 50V	C324	24567684	PF, 0.68 $\mu$ F
C206	24206220	EL, 22 $\mu$ F, $\pm 20\%$ , 50V	C330	24591104	PF, 0.1 $\mu$ F
C212	24794100	EL, 10 $\mu$ F, $\pm 20\%$ , 16V	C331	24669229	EL, 2.2 $\mu$ F, $\pm 20\%$ , 50V
C214	24591334	PF, 0.33 $\mu$ F	C344	24591103	PF, 0.01 $\mu$ F
C219	24781100	Chip, 10pF, $\pm 0.5\text{pF}\%$ , SL	C351	24667222	EL, 2200 $\mu$ F, $\pm 20\%$ , 25V
C220	24781100	Chip, 10pF, $\pm 0.5\text{pF}\%$ , SL	C355	24669010	EL, 1 $\mu$ F, $\pm 20\%$ , 50V
C221	24781100	Chip, 10pF, $\pm 0.5\text{pF}\%$ , SL	C357	24669100	EL, 10 $\mu$ F, $\pm 20\%$ , 50V
C228	24814103	Chip, 0.01 $\mu$ F, +80%, -20%	C360	24667100	EL, 10 $\mu$ F, $\pm 20\%$ , 25V
C229	24669010	EL, 1 $\mu$ F, $\pm 20\%$ , 50V	C361	24669100	EL, 10 $\mu$ F, $\pm 20\%$ , 50V
C230	24763221	EL, 220 $\mu$ F, $\pm 20\%$ , 16V	C362	24591104	PF, 0.1 $\mu$ F
C231	24814103	Chip, 0.01 $\mu$ F, +80%, -20%	C363	24085942	EL, 10 $\mu$ F, $\pm 20\%$ , 16V, Non-Polar
C232	24669010	EL, 1 $\mu$ F, $\pm 20\%$ , 50V	C364	24666100	EL, 10 $\mu$ F, $\pm 20\%$ , 16V
C260	24085967	EL, 47 $\mu$ F, $\pm 20\%$ , 16V, Non-Polar	C370	24669101	EL, 100 $\mu$ F, $\pm 20\%$ , 50V
C261	24669101	EL, 100 $\mu$ F, $\pm 20\%$ , 50V	C371	24669100	EL, 10 $\mu$ F, $\pm 20\%$ , 50V
C262	24814103	Chip, 0.01 $\mu$ F, +80%, -20%	C372	24591104	PF, 0.1 $\mu$ F
C264	24781150	Chip, 15pF, SL	C388	24591334	PF, 0.33 $\mu$ F
C273	24206229	EL, 2.2 $\mu$ F, $\pm 20\%$ , 50V	C403	24591223	PF, 0.022 $\mu$ F
C281	24763101	EL, 100 $\mu$ F, $\pm 20\%$ , 16V	C403	24828124	PF, 0.12 $\mu$ F, 200V
C282	24232103	CD, 0.01 $\mu$ F, +80%, -20%	C404	24797229	EL, 2.2 $\mu$ F, $\pm 20\%$ , 50V
C283	24794100	EL, 10 $\mu$ F, $\pm 20\%$ , 16V	C413	24214821	CD, 820pF, $\pm 10\%$ , 500V
C284	24794100	EL, 10 $\mu$ F, $\pm 20\%$ , 16V	C415	24815392	Chip, 3900pF, $\pm 10\%$
C295	24232103	CD, 0.01 $\mu$ F, +80%, -20%	C416	24678100	EL, 10 $\mu$ F, $\pm 20\%$ , 200V
C303	24214471	CD, 470pF, $\pm 10\%$ , 500V	C417	24214391	CD, 390pF, $\pm 10\%$ , 500V
C305	24617912	EL, 2.2 $\mu$ F, $\pm 10\%$ , 50V	C418	24095883	PF, 0.015 $\mu$ F, $\pm 3\%$ , 630V
C306	24617858	EL, 3300 $\mu$ F, $\pm 20\%$ , 35V	C419	24095803	PF, 0.062 $\mu$ F, 400V
C307	24082270	PF, 0.033 $\mu$ F, 100V	C420	24666101	EL, 100 $\mu$ F, $\pm 20\%$ , 16V

Location No.	Part No.	Description
C423	24095779	PF, 0.062 $\mu$ F, 400V
C430	24814103	Chip, 0.01 $\mu$ F, +80%, -20%
C431	24763102	EL, 1000 $\mu$ F, $\pm$ 20%, 16V
C440	24082326	PF, 1300pF, $\pm$ 3%, 1500V
C443	24082348	PF, 6800pF, $\pm$ 3%, 1500V
C444	24082287	PF, 5100pF, $\pm$ 3%, 1800V
C445	24828473	PF, 0.047 $\mu$ F, 200V
C446	24679330	EL, 33 $\mu$ F, $\pm$ 20%, 250V
C447	24667102	EL, 1000 $\mu$ F, $\pm$ 20%, 25V
C448	24640908	EL, 33 $\mu$ F, $\pm$ 20%, 160V
C460	24669331	EL, 330 $\mu$ F, $\pm$ 20%, 50V
C463	24212152	CD, 1500pF, $\pm$ 10%
C464	24640872	EL, 10 $\mu$ F, $\pm$ 20%, 100V
C465	24591332	PF, 3300pF
C466	24567394	PF, 0.39 $\mu$ F
C467	24820153	PF, 0.015 $\mu$ F, 630V
C468	24567474	PF, 0.47 $\mu$ F
C471	24206479	EL, 4.7 $\mu$ F, $\pm$ 20%, 50V
C475	24820103	PF, 0.01 $\mu$ F, 630V
C477	24092347	CD, 1500pF, $\pm$ 10%, 2kV
C481	24567104	PF, 0.1 $\mu$ F
C482	24591152	PF, 1500pF
C483	24567224	PF, 0.22 $\mu$ F
C484	24567104	PF, 0.1 $\mu$ F
C485	24669101	EL, 100 $\mu$ F, $\pm$ 20%, 50V
C493	24591124	PF, 0.12 $\mu$ F
C501	24781101	Chip, 100pF, SL
C502	24814103	Chip, 0.01 $\mu$ F, +80%, -20%
C503	24763221	EL, 220 $\mu$ F, $\pm$ 20%, 16V
C504	24591222	PF, 2200pF
C505	24774120	Chip, 12pF, CH
C507	24774120	Chip, 12pF, CH
C508	24669010	EL, 1 $\mu$ F, $\pm$ 20%, 50V
C509	24763101	EL, 100 $\mu$ F, $\pm$ 20%, 16V
C510	24763101	EL, 100 $\mu$ F, $\pm$ 20%, 16V
C511	24814103	Chip, 0.01 $\mu$ F, +80%, -20%
C512	24206228	EL, 0.22 $\mu$ F, $\pm$ 20%, 50V
C513	24814103	Chip, 0.01 $\mu$ F, +80%, -20%
C514	24538104	PF, 0.1 $\mu$ F
C515	24538104	PF, 0.1 $\mu$ F
C516	24781102	Chip, 1000pF, SL
C517	24774010	Chip, 1pF, $\pm$ 0.25pF, CH
C519	24774010	Chip, 1pF, $\pm$ 0.25pF, CH
C520	24781102	Chip, 1000pF, SL
C521	24781102	Chip, 1000pF, SL
C524	24781122	Chip, 1200pF, SL
C525	24774181	Chip, 180pF, CH
C554	24814103	Chip, 0.01 $\mu$ F, +80%, -20%
C555	24669010	EL, 1 $\mu$ F, $\pm$ 20%, 50V
C556	24669010	EL, 1 $\mu$ F, $\pm$ 20%, 50V
C601	24590102	PF, 1000pF
C602	24590102	PF, 1000pF
C603	24669100	EL, 10 $\mu$ F, $\pm$ 20%, 50V
C604	24669100	EL, 10 $\mu$ F, $\pm$ 20%, 50V
C605	24667101	EL, 100 $\mu$ F, $\pm$ 20%, 25V
C606	24667101	EL, 100 $\mu$ F, $\pm$ 20%, 25V
C607	24538104	PF, 0.1 $\mu$ F(40PW03G)
C607	24567104	PF, 0.1 $\mu$ F(40PW03B)
C608	24538104	PF, 0.1 $\mu$ F(40PW03G)
C608	24567104	PF, 0.1 $\mu$ F(40PW03B)
C609	24669102	EL, 1000 $\mu$ F, $\pm$ 20%, 50V
C610	24669102	EL, 1000 $\mu$ F, $\pm$ 20%, 50V
C611	24667221	EL, 220 $\mu$ F, $\pm$ 20%, 25V
C613	24666471	EL, 470 $\mu$ F, $\pm$ 20%, 16V

Location No.	Part No.	Description
C636	24666100	EL, 10 $\mu$ F, $\pm$ 20%, 16V
C661	24436101	CD, 100pF
C665	24669229	EL, 2.2 $\mu$ F, $\pm$ 20%, 50V
C666	24669229	EL, 2.2 $\mu$ F, $\pm$ 20%, 50V
C671	24669100	EL, 10 $\mu$ F, $\pm$ 20%, 50V
C672	24232103	CD, 0.01 $\mu$ F, +80%, -20%
C673	24781102	Chip, 1000pF, SL
C674	24669100	EL, 10 $\mu$ F, $\pm$ 20%, 50V
C674	24781102	Chip, 1000pF, SL
C675	24669100	EL, 10 $\mu$ F, $\pm$ 20%, 50V
C675	24781102	Chip, 1000pF, SL
C676	24669100	EL, 10 $\mu$ F, $\pm$ 20%, 50V
C676	24781102	Chip, 1000pF, SL
C677	24668221	EL, 220 $\mu$ F, $\pm$ 20%, 35V
C678	24781102	Chip, 1000pF, SL
C679	24781102	Chip, 1000pF, SL
C680	24669222	EL, 2200 $\mu$ F, $\pm$ 20%, 50V
C681	24781102	Chip, 1000pF, SL
C682	24669010	EL, 1 $\mu$ F, $\pm$ 20%, 50V
C682	24781102	Chip, 1000pF, SL
C696	24762102	EL, 1000 $\mu$ F, $\pm$ 20%, 10V
C701	24781330	Chip, 33pF, SL
C702	24781330	Chip, 33pF, SL
C711	24206100	EL, 10 $\mu$ F, $\pm$ 20%, 50V
C714	24092293	Chip, 0.1 $\mu$ F, +80%, -20%, 25V
C715	24092441	Chip, 1 $\mu$ F, +80%, -20%, 16V
C716	24815822	Chip, 0.0082 $\mu$ F, $\pm$ 10%
C717	24774470	Chip, 47pF, CH
C718	24774470	Chip, 47pF, CH
C719	24794101	EL, 100 $\mu$ F, $\pm$ 20%, 16V
C720	24092293	Chip, 0.1 $\mu$ F, +80%, -20%, 25V
C721	24567104	PF, 0.1 $\mu$ F
C722	24092293	Chip, 0.1 $\mu$ F, +80%, -20%, 25V
C724	24092293	Chip, 0.1 $\mu$ F, +80%, -20%, 25V
C725	24092293	Chip, 0.1 $\mu$ F, +80%, -20%, 25V
C726	24092293	Chip, 0.1 $\mu$ F, +80%, -20%, 25V
C727	24092293	Chip, 0.1 $\mu$ F, +80%, -20%, 25V
C728	24763221	EL, 220 $\mu$ F, $\pm$ 20%, 16V
C729	24092293	Chip, 0.1 $\mu$ F, +80%, -20%, 25V
C730	24567104	PF, 0.1 $\mu$ F
C731	24766010	EL, 1 $\mu$ F, $\pm$ 20%, 50V
C732	24590822	PF, 0.0082 $\mu$ F
C735	24092293	Chip, 0.1 $\mu$ F, +80%, -20%, 25V
C736	24794470	EL, 47 $\mu$ F, $\pm$ 20%, 16V
C739	24092293	Chip, 0.1 $\mu$ F, +80%, -20%, 25V
C740	24092293	Chip, 0.1 $\mu$ F, +80%, -20%, 25V
C741	24794470	EL, 47 $\mu$ F, $\pm$ 20%, 16V
C742	24794470	EL, 47 $\mu$ F, $\pm$ 20%, 16V
C743	24092293	Chip, 0.1 $\mu$ F, +80%, -20%, 25V
C744	24092293	Chip, 0.1 $\mu$ F, +80%, -20%, 25V
C745	24794470	EL, 47 $\mu$ F, $\pm$ 20%, 16V
C746	24794470	EL, 47 $\mu$ F, $\pm$ 20%, 16V
C747	24092293	Chip, 0.1 $\mu$ F, +80%, -20%, 25V
C748	24092293	Chip, 0.1 $\mu$ F, +80%, -20%, 25V
C749	24794470	EL, 47 $\mu$ F, $\pm$ 20%, 16V
C750	24794470	EL, 47 $\mu$ F, $\pm$ 20%, 16V
C756	24781391	Chip, 390pF, SL
C761	24590182	PF, 1800pF
C762	24590562	PF, 5600pF
C763	24774391	Chip, 390pF, CH
C765	24590182	PF, 1800pF
C766	24590562	PF, 5600pF
C767	24774391	Chip, 390pF, CH
C769	24590182	PF, 1800pF



Location No.	Part No.	Description
C770	24590562	PF, 5600pF
C771	24774391	Chip, 390pF, CH
C773	24590182	PF, 1800pF
C774	24590562	PF, 5600pF
C775	24774391	Chip, 390pF, CH
C777	24590182	PF, 1800pF
C778	24590562	PF, 5600pF
C779	24774391	Chip, 390pF, CH
C781	24590182	PF, 1800pF
C782	24590562	PF, 5600pF
C783	24774391	Chip, 390pF, CH
C795	24761221	EL, 220 $\mu$ F, $\pm$ 20%, 6.3V
C798	24763101	EL, 100 $\mu$ F, $\pm$ 20%, 16V
C799	24763101	EL, 100 $\mu$ F, $\pm$ 20%, 16V
△C801	24082374	PF, 0.22 $\mu$ F, $\pm$ 20%, AC250V
△C802	24092557	CD, 220pF, $\pm$ 20%, AC250V
△C803	24092557	CD, 220pF, $\pm$ 20%, AC250V
△C804	24092570	CD, 3300pF, $\pm$ 20%, AC250V
△C805	24082374	PF, 0.22 $\mu$ F, $\pm$ 20%, AC250V
C807	24073058	EL, 2200 $\mu$ F, $\pm$ 20%, 25V
C808	24617787	EL, 470 $\mu$ F, $\pm$ 20%, 16V
C809	24567105	PF, 1 $\mu$ F
C810	24086935	EL, 560 $\mu$ F, $\pm$ 20%, 400V
C811	24676478	EL, 0.47 $\mu$ F, $\pm$ 20%, 100V
C812	24092281	CD, 4700pF, $\pm$ 20%, AC250V
C813	24092281	CD, 4700pF, $\pm$ 20%, AC250V
C814	24678229	EL, 2.2 $\mu$ F, $\pm$ 20%, 200V
C815	24567474	PF, 0.47 $\mu$ F
C816	24617817	EL, 22 $\mu$ F, $\pm$ 20%, 50V
C817	24567224	PF, 0.22 $\mu$ F
C819	24214102	CD, 1000pF, $\pm$ 10%, 500V
C820	24567224	PF, 0.22 $\mu$ F
C821	24092480	CD, 680pF, $\pm$ 10%, 2kV
C822	24092481	CD, 820pF, $\pm$ 10%, 2kV
C823	24092478	CD, 470pF, $\pm$ 10%, 2kV
C824	24214103	CD, 0.01 $\mu$ F, $\pm$ 10%, 500V
C825	24591472	PF, 4700pF
C826	24092474	CD, 220pF, $\pm$ 10%, 2kV
C828	24820683	PF, 0.068 $\mu$ F, 630V
C829	24617820	EL, 100 $\mu$ F, $\pm$ 20%, 50V
C830	24567105	PF, 1 $\mu$ F
C831	24669220	EL, 22 $\mu$ F, $\pm$ 20%, 50V
C853	24668102	EL, 1000 $\mu$ F, $\pm$ 20%, 35V
C855	24214471	CD, 470pF, $\pm$ 10%, 500V
C856	24214471	CD, 470pF, $\pm$ 10%, 500V
C857	24214471	CD, 470pF, $\pm$ 10%, 500V
C858	24214471	CD, 470pF, $\pm$ 10%, 500V
C859	24214471	CD, 470pF, $\pm$ 10%, 500V
C860	24669471	EL, 470 $\mu$ F, $\pm$ 20%, 50V
C861	24668332	EL, 3300 $\mu$ F, $\pm$ 20%, 35V
C862	24668471	EL, 470 $\mu$ F, $\pm$ 20%, 35V
C863	24668332	EL, 3300 $\mu$ F, $\pm$ 20%, 35V
C864	24668471	EL, 470 $\mu$ F, $\pm$ 20%, 35V
C865	24214471	CD, 470pF, $\pm$ 10%, 500V
C866	24214471	CD, 470pF, $\pm$ 10%, 500V
C867	24214471	CD, 470pF, $\pm$ 10%, 500V
C868	24214471	CD, 470pF, $\pm$ 10%, 500V
C869	24669222	EL, 2200 $\mu$ F, $\pm$ 20%, 50V
C870	24214471	CD, 470pF, $\pm$ 10%, 500V
C871	24214471	CD, 470pF, $\pm$ 10%, 500V
C872	24214471	CD, 470pF, $\pm$ 10%, 500V
C873	24214471	CD, 470pF, $\pm$ 10%, 500V
C874	24212102	CD, 1000pF, $\pm$ 10%
C875	24667472	EL, 4700 $\mu$ F, $\pm$ 20%, 25V

Location No.	Part No.	Description
C876	24086916	EL, 330 $\mu$ F, $\pm$ 20%, 160V
C877	24092475	CD, 220pF, $\pm$ 10%, 2kV
C878	24092475	CD, 220pF, $\pm$ 10%, 2kV
C879	24092475	CD, 220pF, $\pm$ 10%, 2kV
C880	24092475	CD, 220pF, $\pm$ 10%, 2kV
C881	24567474	PF, 0.47 $\mu$ F
C882	24617817	EL, 22 $\mu$ F, $\pm$ 20%, 50V
C883	24082229	PF, 0.1 $\mu$ F, $\pm$ 10%, 250V
C884	24617816	EL, 10 $\mu$ F, $\pm$ 20%, 50V
C885	24617813	EL, 2.2 $\mu$ F, $\pm$ 20%, 50V
C886	24677470	EL, 47 $\mu$ F, $\pm$ 20%, 160V
C889	24669010	EL, 1 $\mu$ F, $\pm$ 20%, 50V
C891	24669010	EL, 1 $\mu$ F, $\pm$ 20%, 50V
C901	24211102	CD, 1000pF, $\pm$ 10%, 2kV
C902	24794100	EL, 10 $\mu$ F, $\pm$ 20%, 16V
C903	24232103	CD, 0.01 $\mu$ F, +80%, -20%
C904	24436391	CD, 390pF
C905	24214102	CD, 1000pF, $\pm$ 10%, 500V
C911	24211102	CD, 1000pF, $\pm$ 10%, 2kV
C912	24794100	EL, 10 $\mu$ F, $\pm$ 20%, 16V
C913	24232103	CD, 0.01 $\mu$ F, +80%, -20%
C914	24436561	CD, 560pF
C915	24679330	EL, 33 $\mu$ F, $\pm$ 20%, 250V
C915A	23960136	Adhesive, TSE3843-W
C916	24794101	EL, 100 $\mu$ F, $\pm$ 20%, 16V
C921	24211102	CD, 1000pF, $\pm$ 10%, 2kV
C922	24794100	EL, 10 $\mu$ F, $\pm$ 20%, 16V
C924	24232103	CD, 0.01 $\mu$ F, +80%, -20%
C926	24436471	CD, 470pF
C941	24797478	EL, 0.47 $\mu$ F, $\pm$ 20%, 50V
C943	24667102	EL, 1000 $\mu$ F, $\pm$ 20%, 25V
C944	24206100	EL, 10 $\mu$ F, $\pm$ 20%, 50V
C961	24666101	EL, 100 $\mu$ F, $\pm$ 20%, 16V
C962	24203100	EL, 10 $\mu$ F, $\pm$ 20%, 16V
C963	24232103	CD, 0.01 $\mu$ F, +80%, -20%
C964	24591104	PF, 0.1 $\mu$ F
C6101	24232103	CD, 0.01 $\mu$ F, +80%, -20%
C6102	24232103	CD, 0.01 $\mu$ F, +80%, -20%
C7701	24761221	EL, 220 $\mu$ F, $\pm$ 20%, 6.3V
C7703	24232103	CD, 0.01 $\mu$ F, +80%, -20%
C7721	24212102	CD, 1000pF, $\pm$ 10%
C7722	24436101	CD, 100pF
C7724	24667101	EL, 100 $\mu$ F, $\pm$ 20%, 25V
C7725	24667101	EL, 100 $\mu$ F, $\pm$ 20%, 25V
C7726	24212102	CD, 1000pF, $\pm$ 10%
C7727	24436101	CD, 100pF
C7729	24212102	CD, 1000pF, $\pm$ 10%
C7730	24436101	CD, 100pF
C7732	24212102	CD, 1000pF, $\pm$ 10%
C7733	24436101	CD, 100pF
C7735	24667101	EL, 100 $\mu$ F, $\pm$ 20%, 25V
C7736	24669101	EL, 100 $\mu$ F, $\pm$ 20%, 50V
C7737	24212102	CD, 1000pF, $\pm$ 10%
C7738	24436101	CD, 100pF
C7740	24212102	CD, 1000pF, $\pm$ 10%
C7741	24436101	CD, 100pF
C7742	24436330	CD, 33pF
C7743	24436330	CD, 33pF
C7747	24667101	EL, 100 $\mu$ F, $\pm$ 20%, 25V
C7748	24567104	PF, 0.1 $\mu$ F
C7749	24567104	PF, 0.1 $\mu$ F
C7750	24667101	EL, 100 $\mu$ F, $\pm$ 20%, 25V
C7751	24667101	EL, 100 $\mu$ F, $\pm$ 20%, 25V
C7752	24567104	PF, 0.1 $\mu$ F

Location No.	Part No.	Description
C7753	24567104	PF, 0.1 $\mu$ F
C7754	24667101	EL, 100 $\mu$ F, $\pm$ 20%, 25V
C7755	24667101	EL, 100 $\mu$ F, $\pm$ 20%, 25V
C7756	24567104	PF, 0.1 $\mu$ F
C7757	24567104	PF, 0.1 $\mu$ F
C7758	24667101	EL, 100 $\mu$ F, $\pm$ 20%, 25V
C7760	24667470	EL, 47 $\mu$ F, $\pm$ 20%, 25V
C7761	24667470	EL, 47 $\mu$ F, $\pm$ 20%, 25V
C7762	24669100	EL, 10 $\mu$ F, $\pm$ 20%, 50V
C7763	24667470	EL, 47 $\mu$ F, $\pm$ 20%, 25V
C7764	24598331	PF, 330pF
C7767	24667470	EL, 47 $\mu$ F, $\pm$ 20%, 25V
C7768	24567104	PF, 0.1 $\mu$ F
C7769	24232103	CD, 0.01 $\mu$ F, +80%, -20%
C7770	24669470	EL, 47 $\mu$ F, $\pm$ 20%, 50V
C7771	24567103	PF, 0.01 $\mu$ F
C7772	24667101	EL, 100 $\mu$ F, $\pm$ 20%, 25V
C7773	24669101	EL, 100 $\mu$ F, $\pm$ 20%, 50V
C7774	24436331	CD, 330pF
C7775	24667101	EL, 100 $\mu$ F, $\pm$ 20%, 25V
C7776	24667470	EL, 47 $\mu$ F, $\pm$ 20%, 25V
C7777	24669470	EL, 47 $\mu$ F, $\pm$ 20%, 50V
C7778	24567104	PF, 0.1 $\mu$ F
C7779	24669479	EL, 4.7 $\mu$ F, $\pm$ 20%, 50V
C7780	24591102	PF, 1000pF
C8301	24666101	EL, 100 $\mu$ F, $\pm$ 20%, 16V
C8303	24669100	EL, 10 $\mu$ F, $\pm$ 20%, 50V
C8304	24666101	EL, 100 $\mu$ F, $\pm$ 20%, 16V
C8306	24666470	EL, 47 $\mu$ F, $\pm$ 20%, 16V
C8307	24591334	PF, 0.33 $\mu$ F
C9602	24794100	EL, 10 $\mu$ F, $\pm$ 20%, 16V
CA14	24232103	CD, 0.01 $\mu$ F, +80%, -20%
CA15	24232103	CD, 0.01 $\mu$ F, +80%, -20%
CA19	24436101	CD, 100pF
CA24	24436101	CD, 100pF
CA41	24436101	CD, 100pF
CA42	24436101	CD, 100pF
CA43	24436101	CD, 100pF
CA68	24794100	EL, 10 $\mu$ F, $\pm$ 20%, 16V
CA69	24232103	CD, 0.01 $\mu$ F, +80%, -20%
CA106	24436101	CD, 100pF
CA107	24538104	PF, 0.1 $\mu$ F(40PW03G)
CA107	24567104	PF, 0.1 $\mu$ F(40PW03B)
CA108	24538103	PF, 0.01 $\mu$ F(40PW03G)
CA108	24590103	PF, 0.01 $\mu$ F(40PW03B)
CA109	24538103	PF, 0.01 $\mu$ F(40PW03G)
CA109	24590103	PF, 0.01 $\mu$ F(40PW03B)
CA420	24794100	EL, 10 $\mu$ F, $\pm$ 20%, 16V
CA430	24232103	CD, 0.01 $\mu$ F, +80%, -20%
CA440	24232103	CD, 0.01 $\mu$ F, +80%, -20%
CB01	24794470	EL, 47 $\mu$ F, $\pm$ 20%, 16V
CB90	24232103	CD, 0.01 $\mu$ F, +80%, -20%
CC08	24815102	Chip, 0.001 $\mu$ F, $\pm$ 10%
CC10	24781820	Chip, 82pF, SL
CC15	24212102	CD, 1000pF, $\pm$ 10%
CC23	24814103	Chip, 0.01 $\mu$ F, +80%, -20%
CC28	24232103	CD, 0.01 $\mu$ F, +80%, -20%
CC29	24232103	CD, 0.01 $\mu$ F, +80%, -20%
CC30	24567474	PF, 0.47 $\mu$ F
CC39	24232103	CD, 0.01 $\mu$ F, +80%, -20%
CC40	24781470	Chip, 47pF, SL
CC41	24781470	Chip, 47pF, SL
CC42	24781470	Chip, 47pF, SL
CC45	24774050	CD, 5pF, $\pm$ 0.25pF, CH

Location No.	Part No.	Description
CC46	24774050	CD, 5pF, $\pm$ 0.25pF, CH
CC47	24232103	CD, 0.01 $\mu$ F, +80%, -20%
CC48	24232103	CD, 0.01 $\mu$ F, +80%, -20%
CF03	24567104	PF, 0.1 $\mu$ F
CF04	24766101	EL, 100 $\mu$ F, $\pm$ 20%, 50V
CF05	24766101	EL, 100 $\mu$ F, $\pm$ 20%, 50V
CF06	24774220	Chip, 22pF, CH
CF07	24774220	Chip, 22pF, CH
CF08	24567104	PF, 0.1 $\mu$ F
CF09	24567104	PF, 0.1 $\mu$ F
CF10	24206100	EL, 10 $\mu$ F, $\pm$ 20%, 50V
CF11	24567104	PF, 0.1 $\mu$ F
CF12	24814103	Chip, 0.01 $\mu$ F, +80%, -20%
CF14	24814103	Chip, 0.01 $\mu$ F, +80%, -20%
CF16	24567224	PF, 0.22 $\mu$ F
CF18	24794101	EL, 100 $\mu$ F, $\pm$ 20%, 16V
CF19	24814103	Chip, 0.01 $\mu$ F, +80%, -20%
CF20	24766010	EL, 1 $\mu$ F, $\pm$ 20%, 50V
CQ01	24781102	Chip, 1000pF, SL
CQ02	24781820	Chip, 82pF, SL
CQ03	24781102	Chip, 1000pF, SL
CQ04	24203100	EL, 10 $\mu$ F, $\pm$ 20%, 16V
CQ05	24591563	PF, 0.056 $\mu$ F
CQ07	24591203	PF, 0.02 $\mu$ F
CQ08	24567683	PF, 0.068 $\mu$ F
CQ09	24206229	EL, 2.2 $\mu$ F, $\pm$ 20%, 50V
CQ10	24591223	PF, 0.022 $\mu$ F
CQ11	24206229	EL, 2.2 $\mu$ F, $\pm$ 20%, 50V
CQ12	24781820	Chip, 82pF, SL
CQ13	24669010	EL, 1 $\mu$ F, $\pm$ 20%, 50V
CQ14	24669010	EL, 1 $\mu$ F, $\pm$ 20%, 50V
CQ15	24763101	EL, 100 $\mu$ F, $\pm$ 20%, 16V
CQ16	24814103	Chip, 0.01 $\mu$ F, +80%, -20%
CQ17	24774150	Chip, 15pF, CH
CQ18	24781820	Chip, 82pF, SL
CQ19	24590103	PF, 0.01 $\mu$ F
CQ20	24567104	PF, 0.1 $\mu$ F
CQ21	24794470	EL, 47 $\mu$ F, $\pm$ 20%, 16V
CQ22	24814103	Chip, 0.01 $\mu$ F, +80%, -20%
CQ23	24567104	PF, 0.1 $\mu$ F
CQ24	24567104	PF, 0.1 $\mu$ F
CQ25	24797100	EL, 10 $\mu$ F, $\pm$ 20%, 50V
CQ26	24567104	PF, 0.1 $\mu$ F
CQ27	24567104	PF, 0.1 $\mu$ F
CQ28	24797478	EL, 0.47 $\mu$ F, $\pm$ 20%, 50V
CQ29	24794101	EL, 100 $\mu$ F, $\pm$ 20%, 16V
CQ30	24814103	Chip, 0.01 $\mu$ F, +80%, -20%
CQ31	24797478	EL, 0.47 $\mu$ F, $\pm$ 20%, 50V
CQ32	24590103	PF, 0.01 $\mu$ F
CQ33	24567104	PF, 0.1 $\mu$ F
CQ34	24567104	PF, 0.1 $\mu$ F
CQ35	24206478	EL, 0.47 $\mu$ F, $\pm$ 20%, 50V
CQ36	24206478	EL, 0.47 $\mu$ F, $\pm$ 20%, 50V
CQ37	24669010	EL, 1 $\mu$ F, $\pm$ 20%, 50V
CQ38	24669010	EL, 1 $\mu$ F, $\pm$ 20%, 50V
CQ39	24669010	EL, 1 $\mu$ F, $\pm$ 20%, 50V
CQ40	24781820	Chip, 82pF, SL
CQ41	24781090	Chip, 9pF, $\pm$ 0.5pF, SL
CQ42	24781090	Chip, 9pF, $\pm$ 0.5pF, SL
CQ43	24781090	Chip, 9pF, $\pm$ 0.5pF, SL
CQ45	24781102	Chip, 1000pF, SL
CQ46	24781102	Chip, 1000pF, SL
CQ61	24781102	Chip, 1000pF, SL
CQ62	24781470	Chip, 47pF, SL

Location No.	Part No.	Description
CQ63	24781470	Chip, 47pF, SL
CR01	24206010	EL, 1 $\mu$ F, $\pm$ 20%, 50V
CR01	24567104	PF, 0.1 $\mu$ F
CR02	24232103	CD, 0.01 $\mu$ F, +80%, -20%
CR02	24567104	PF, 0.1 $\mu$ F
CR03	24436101	CD, 100pF
CR03	24567104	PF, 0.1 $\mu$ F
CR04	24567104	PF, 0.1 $\mu$ F
CR05	24567104	PF, 0.1 $\mu$ F
CR06	24567104	PF, 0.1 $\mu$ F
CR07	24814103	Chip, 0.01 $\mu$ F, +80%, -20%
CR08	24794100	EL, 10 $\mu$ F, $\pm$ 20%, 16V
CR09	24538104	PF, 0.1 $\mu$ F(40PW03G)
CR09	24567104	PF, 0.1 $\mu$ F
CR09	24814103	Chip, 0.01 $\mu$ F, +80%, -20%
CR10	24794470	EL, 47 $\mu$ F, $\pm$ 20%, 16V
CR11	24538104	PF, 0.1 $\mu$ F(40PW03G)
CR11	24567104	PF, 0.1 $\mu$ F(40PW03B)
CR12	24567104	PF, 0.1 $\mu$ F
CR13	24567104	PF, 0.1 $\mu$ F
CR14	24567104	PF, 0.1 $\mu$ F
CR18	24538104	PF, 0.1 $\mu$ F(40PW03G)
CR18	24567104	PF, 0.1 $\mu$ F(40PW03B)
CR19	24538104	PF, 0.1 $\mu$ F(40PW03G)
CR19	24567104	PF, 0.1 $\mu$ F(40PW03B)
CR20	24538104	PF, 0.1 $\mu$ F(40PW03G)
CR20	24567104	PF, 0.1 $\mu$ F(40PW03B)
CS01	24085944	EL, 2.2 $\mu$ F, $\pm$ 20%, 50V, Non-Polar
CS02	24085944	EL, 2.2 $\mu$ F, $\pm$ 20%, 50V, Non-Polar
CS03	24206229	EL, 2.2 $\mu$ F, $\pm$ 20%, 50V
CS04	24206229	EL, 2.2 $\mu$ F, $\pm$ 20%, 50V
CS05	24206229	EL, 2.2 $\mu$ F, $\pm$ 20%, 50V
CS06	24206229	EL, 2.2 $\mu$ F, $\pm$ 20%, 50V
CS07	24206229	EL, 2.2 $\mu$ F, $\pm$ 20%, 50V
CS08	24206229	EL, 2.2 $\mu$ F, $\pm$ 20%, 50V
CS12	24781102	Chip, 1000pF, SL
CS13	24781102	Chip, 1000pF, SL
CS14	24206100	EL, 10 $\mu$ F, $\pm$ 20%, 50V
CS15	24206100	EL, 10 $\mu$ F, $\pm$ 20%, 50V
CS17	24203100	EL, 10 $\mu$ F, $\pm$ 20%, 16V
CS18	24203100	EL, 10 $\mu$ F, $\pm$ 20%, 16V
CS19	24206478	EL, 0.47 $\mu$ F, $\pm$ 20%, 50V
CS22	24203100	EL, 10 $\mu$ F, $\pm$ 20%, 16V
CS23	24203100	EL, 10 $\mu$ F, $\pm$ 20%, 16V
CS53	24781102	Chip, 1000pF, SL
CV01	24567103	PF, 0.01 $\mu$ F
CV02	24085970	EL, 10 $\mu$ F, $\pm$ 20%, 16V, Non-Polar
CV03	24203100	EL, 10 $\mu$ F, $\pm$ 20%, 16V
CV04	24203100	EL, 10 $\mu$ F, $\pm$ 20%, 16V
CV05	24814103	Chip, 0.01 $\mu$ F, +80%, -20%
CV06	24203100	EL, 10 $\mu$ F, $\pm$ 20%, 16V
CV08	24763102	EL, 1000 $\mu$ F, $\pm$ 20%, 16V
CV10	24085970	EL, 10 $\mu$ F, $\pm$ 20%, 16V, Non-Polar
CV11	24781331	Chip, 330pF, SL
CV12	24092178	Chip, 0.1 $\mu$ F, $\pm$ 10%, 25V
CV13	24814103	Chip, 0.01 $\mu$ F, +80%, -20%
CV14	24781102	Chip, 1000pF, SL
CV15	24781102	Chip, 1000pF, SL
CV16	24781102	Chip, 1000pF, SL
CV17	24781102	Chip, 1000pF, SL

Location No.	Part No.	Description
CV18	24781102	Chip, 1000pF, SL
CV19	24781102	Chip, 1000pF, SL
CV20	24781430	Chip, 43pF, SL
CV23	24203101	EL, 100 $\mu$ F, $\pm$ 20%, 16V
CV24	24814103	Chip, 0.01 $\mu$ F, +80%, -20%
CV25	24763471	EL, 470 $\mu$ F, $\pm$ 20%, 16V
CV31	24781102	Chip, 1000pF, SL
CV34	24781102	Chip, 1000pF, SL
CV35	24814103	Chip, 0.01 $\mu$ F, +80%, -20%
CV37	24781102	Chip, 1000pF, SL
CV39	24203101	EL, 100 $\mu$ F, $\pm$ 20%, 16V
CV40	24814103	Chip, 0.01 $\mu$ F, +80%, -20%
CV46	24212332	CD, 3300pF, $\pm$ 10%
CV47	24212332	CD, 3300pF, $\pm$ 10%
CV48	24212102	CD, 1000pF, $\pm$ 10%
CV65	24203101	EL, 100 $\mu$ F, $\pm$ 20%, 16V
CV66	24203101	EL, 100 $\mu$ F, $\pm$ 20%, 16V
CV67	24763471	EL, 470 $\mu$ F, $\pm$ 20%, 16V
CV68	24763471	EL, 470 $\mu$ F, $\pm$ 20%, 16V
CV78	24781330	Chip, 33pF, SL
CW01	24781121	Chip, 120pF, SL
CW02	24781121	Chip, 120pF, SL
CW03	24781470	Chip, 47pF, SL
CW04	24085945	EL, 2.2 $\mu$ F, $\pm$ 20%, 50V, Non-Polar
CW04	24591822	PF, 8200pF
CW05	24212103	CD, 0.01 $\mu$ F, $\pm$ 10%
CW05	24781121	Chip, 120pF, SL
CW06	24781121	Chip, 120pF, SL
CW07	24206229	EL, 2.2 $\mu$ F, $\pm$ 20%, 50V
CW07	24666470	EL, 47 $\mu$ F, $\pm$ 20%, 16V
CW08	24781121	Chip, 120pF, SL
CW09	24781121	Chip, 120pF, SL
CW10	24206229	EL, 2.2 $\mu$ F, $\pm$ 20%, 50V
CW11	24781330	Chip, 33pF, SL
CW12	24666470	EL, 47 $\mu$ F, $\pm$ 20%, 16V
CW12	24781820	Chip, 82pF, SL
CW13	24781330	Chip, 33pF, SL
CW13	24790100	EL, 10 $\mu$ F, $\pm$ 20%, 160V
CW14	24436101	CD, 100pF
CW14	24781820	Chip, 82pF, SL
CW15	24214472	CD, 4700pF, $\pm$ 10%, 500V
CW15	24781330	Chip, 33pF, SL
CW16	24436101	CD, 100pF
CW16	24781820	Chip, 82pF, SL
CW17	24214472	CD, 4700pF, $\pm$ 10%, 500V
CW18	24666470	EL, 47 $\mu$ F, $\pm$ 20%, 16V
CW19	24435560	CD, 56pF, 500V
CW20	24790100	EL, 10 $\mu$ F, $\pm$ 20%, 160V
CW21	24794470	EL, 47 $\mu$ F, $\pm$ 20%, 16V
CW22	24212561	CD, 560pF, $\pm$ 10%
CW26	24212102	CD, 1000pF, $\pm$ 10%
CW27	24085986	EL, 10 $\mu$ F, $\pm$ 20%, 10V, Non-Polar
CW28	24085986	EL, 10 $\mu$ F, $\pm$ 20%, 10V, Non-Polar
CW29	24085986	EL, 10 $\mu$ F, $\pm$ 20%, 10V, Non-Polar
CW30	24202221	EL, 220 $\mu$ F, $\pm$ 20%, 10V
CW31	24092294	Chip, 0.33 $\mu$ F, +80%, -20%, 16V
CW32	24781331	Chip, 330pF, SL
CW33	24092294	Chip, 0.33 $\mu$ F, +80%, -20%, 16V

Location No.	Part No.	Description
CW34	24814103	Chip, 0.01 $\mu$ F, +80%, -20%
CW35	24092293	Chip, 0.1 $\mu$ F, +80%, -20%, 25V
CW36	24814103	Chip, 0.01 $\mu$ F, +80%, -20%
CW37	24814103	Chip, 0.01 $\mu$ F, +80%, -20%
CW38	24202101	EL, 100 $\mu$ F, $\pm$ 20%, 10V
CW39	24092293	Chip, 0.1 $\mu$ F, +80%, -20%, 25V
CW40	24203101	EL, 100 $\mu$ F, $\pm$ 20%, 16V
CW41	24092293	Chip, 0.1 $\mu$ F, +80%, -20%, 25V
CW42	24201101	EL, 100 $\mu$ F, 6.3V
CW43	24092293	Chip, 0.1 $\mu$ F, +80%, -20%, 25V
CW44	24201101	EL, 100 $\mu$ F, 6.3V
CW45	24092293	Chip, 0.1 $\mu$ F, +80%, -20%, 25V
CW46	24206010	EL, 1 $\mu$ F, $\pm$ 20%, 50V
CW47	24092293	Chip, 0.1 $\mu$ F, +80%, -20%, 25V
CW48	24092293	Chip, 0.1 $\mu$ F, +80%, -20%, 25V
CW49	24092293	Chip, 0.1 $\mu$ F, +80%, -20%, 25V
CW50	24202221	EL, 220 $\mu$ F, $\pm$ 20%, 10V
CW51	24092293	Chip, 0.1 $\mu$ F, +80%, -20%, 25V
CW52	24092293	Chip, 0.1 $\mu$ F, +80%, -20%, 25V
CW53	24092293	Chip, 0.1 $\mu$ F, +80%, -20%, 25V
CW54	24092293	Chip, 0.1 $\mu$ F, +80%, -20%, 25V
CW55	24815472	Chip, 0.0047 $\mu$ F, $\pm$ 10%
CW56	24781221	Chip, 220pF, SL
CW60	24092441	Chip, 1 $\mu$ F, +80%, -20%, 16V
CW61	24781182	Chip, 1800pF, SL
CW62	24781182	Chip, 1800pF, SL
CW68	24092293	Chip, 0.1 $\mu$ F, +80%, -20%, 25V
CW70	24814103	Chip, 0.01 $\mu$ F, +80%, -20%
CW72	24567103	PF, 0.01 $\mu$ F
CW73	24774471	Chip, 470pF, CH
CW74	24814103	Chip, 0.01 $\mu$ F, +80%, -20%
CW75	24092293	Chip, 0.1 $\mu$ F, +80%, -20%, 25V
CW80	24092441	Chip, 1 $\mu$ F, +80%, -20%, 16V
CW81	24092441	Chip, 1 $\mu$ F, +80%, -20%, 16V
CW82	24781330	Chip, 33pF, SL
CW83	24781330	Chip, 33pF, SL
CW85	24781330	Chip, 33pF, SL
CW86	24781330	Chip, 33pF, SL
CW87	24781330	Chip, 33pF, SL
CW88	24781330	Chip, 33pF, SL
CW89	24781330	Chip, 33pF, SL
CW90	24781330	Chip, 33pF, SL
CW91	24781330	Chip, 33pF, SL
CW92	24781330	Chip, 33pF, SL
CW93	24781330	Chip, 33pF, SL
CW94	24781101	Chip, 100pF, SL
CW95	24781101	Chip, 100pF, SL
CW97	24781101	Chip, 100pF, SL
CZ03	24092442	Chip, 0.47 $\mu$ F, +80%, -20%, 16V
CZ05	24814103	Chip, 0.01 $\mu$ F, +80%, -20%
CZ07	24092178	Chip, 0.1 $\mu$ F, $\pm$ 10%, 25V
CZ09	24781220	Chip, 22pF, SL
CZ10	24781100	Chip, 10pF, $\pm$ 0.5pF%, SL
CZ11	24781220	Chip, 22pF, SL
CZ12	24814103	Chip, 0.01 $\mu$ F, +80%, -20%
CZ13	24814103	Chip, 0.01 $\mu$ F, +80%, -20%
CZ14	24203100	EL, 10 $\mu$ F, $\pm$ 20%, 16V
CZ17	24814103	Chip, 0.01 $\mu$ F, +80%, -20%
CZ19	24781181	Chip, 180pF, SL
CZ20	24815103	Chip, 0.01 $\mu$ F, $\pm$ 10%
CZ21	24781122	Chip, 1200pF, SL
CZ22	24203100	EL, 10 $\mu$ F, $\pm$ 20%, 16V
CZ23	24814103	Chip, 0.01 $\mu$ F, +80%, -20%

Location No.	Part No.	Description
CZ24	24814103	Chip, 0.01 $\mu$ F, +80%, -20%
CZ25	24203100	EL, 10 $\mu$ F, $\pm$ 20%, 16V
CZ26	24814103	Chip, 0.01 $\mu$ F, +80%, -20%
CZ28	24814103	Chip, 0.01 $\mu$ F, +80%, -20%
CZ29	24814103	Chip, 0.01 $\mu$ F, +80%, -20%
CZ30	24203100	EL, 10 $\mu$ F, $\pm$ 20%, 16V
CZ31	24092178	Chip, 0.1 $\mu$ F, $\pm$ 10%, 25V
CZ32	24781470	Chip, 47pF, SL
CZ33	24781470	Chip, 47pF, SL
CZ34	24781470	Chip, 47pF, SL
CZ35	24781470	Chip, 47pF, SL
CZ45	24781100	Chip, 10pF, $\pm$ 0.5pF%, SL

### RESISTORS

R101	24382223	OMF, 22k ohm, 1W
R201	24872101	Chip, 100 ohm, 1/16W
R204	24872104	Chip, 100k ohm, 1/16W
R205	24872101	Chip, 100 ohm, 1/16W
R206	24872471	Chip, 470 ohm, 1/16W
R207	24872103	Chip, 10k ohm, 1/16W
R208	24872103	Chip, 10k ohm, 1/16W
R209	24872103	Chip, 10k ohm, 1/16W
R210	24872101	Chip, 100 ohm, 1/16W
R211	24872101	Chip, 100 ohm, 1/16W
R212	24872101	Chip, 100 ohm, 1/16W
R213	24872681	Chip, 680 ohm, 1/16W
R214	24872681	Chip, 680 ohm, 1/16W
R215	24872681	Chip, 680 ohm, 1/16W
R216	24872103	Chip, 10k ohm, 1/16W
R218	24872101	Chip, 100 ohm, 1/16W
R219	24872101	Chip, 100 ohm, 1/16W
R220	24872101	Chip, 100 ohm, 1/16W
R222	24872333	Chip, 33k ohm, 1/16W
R223	24872332	Chip, 3300 ohm, 1/16W
R229	24872272	Chip, 2700 ohm, 1/16W
R231	24000824	Chip, Jumper, 2125 type
R239	24000824	Chip, Jumper, 2125 type
R260	24872153	Chip, 15k ohm, 1/16W
R261	24872682	Chip, 6800 ohm, 1/16W
R266	24872102	Chip, 1k ohm, 1/16W
R267	24872182	Chip, 1800 ohm, 1/16W
R268	24872101	Chip, 100 ohm, 1/16W
R269	24872821	Chip, 820 ohm, 1/16W
R273	24872473	Chip, 47k ohm, 1/16W
R274	24872102	Chip, 1k ohm, 1/16W
R275	24872101	Chip, 100 ohm, 1/16W
R276	24872683	Chip, 68k ohm, 1/16W
R277	24872103	Chip, 10k ohm, 1/16W
R281	24366821	CF, 820 ohm
R282	24366102	CF, 1k ohm
R283	24366472	CF, 4700 ohm
R291	24366123	CF, 12k ohm
R292	24366103	CF, 10k ohm
R293	24366333	CF, 33k ohm
R295	24366102	CF, 1k ohm
R296	24366101	CF, 100 ohm
R297	24366102	CF, 1k ohm
R298	24366113	CF, 11k ohm
R299	24366153	CF, 15k ohm
R301	24366102	CF, 1k ohm
R302	24366101	CF, 100 ohm
R303	24321129	MF, 1.2 ohm, 1/2W
R304	24366223	CF, 22k ohm
R305	24322828	MF, 0.82 ohm, 1W

Location No.	Part No.	Description
R306	24366333	CF, 33k ohm
R307	24366224	CF, 220k ohm
R308	24382391	OMF, 390 ohm, 1W
R312	24366103	CF, 10k ohm
R313	24366153	CF, 15k ohm
R315	24366102	CF, 1k ohm
R316	24366105	CF, 1M ohm
R317	24366104	CF, 100k ohm
R318	24366101	CF, 100 ohm
R319	24366101	CF, 100 ohm
R321	24872682	Chip, 6800 ohm, 1/16W
R327	24000187	FR, 3.3 ohm, 1W
R329	24366103	CF, 10k ohm
R330	24366102	CF, 1k ohm
R331	24366152	CF, 1500 ohm
R332	24366222	CF, 2200 ohm
R333	24366823	CF, 82k ohm
R334	24366823	CF, 82k ohm
R335	24366104	CF, 100k ohm
R336	24383221	OMF, 220 ohm, 2W
R341	24366622	CF, 6200 ohm
R343	24366153	CF, 15k ohm
R346	24366102	CF, 1k ohm
R351	24552101	OMF, 100 ohm, 1/2W
R352	24366222	CF, 2200 ohm
R353	24366682	CF, 6800 ohm
R354	24366222	CF, 2200 ohm
R356	24366562	CF, 5600 ohm
R357	24382114	OMF, 110k ohm, 1W
R358	24366682	CF, 6800 ohm
R359	24366103	CF, 10k ohm
R360	24366102	CF, 1k ohm
R361	24366113	CF, 11k ohm
R362	24366754	CF, 750k ohm
R363	24366103	CF, 10k ohm
R364	24366103	CF, 10k ohm
R365	24366103	CF, 10k ohm
R366	24366103	CF, 10k ohm
R367	24366473	CF, 47k ohm
R368	24366473	CF, 47k ohm
R369	24366102	CF, 1k ohm
R370	24321159	MF, 1.5 ohm, 1/2W
R371	24366682	CF, 6800 ohm
R372	24366472	CF, 4700 ohm
R373	24366152	CF, 1500 ohm
R374	24366473	CF, 47k ohm
R375	24366102	CF, 1k ohm
R376	24384221	OMF, 220 ohm, 3W
R377	24384221	OMF, 220 ohm, 3W
R378	24366102	CF, 1k ohm
R379	24366562	CF, 5600 ohm
R386	24366472	CF, 4700 ohm
R388	24366392	CF, 3900 ohm
R390	24382561	OMF, 560 ohm, 1W
R391	24382561	OMF, 560 ohm, 1W
R392	24382561	OMF, 560 ohm, 1W
R393	24366184	CF, 180k ohm
R394	24366153	CF, 15k ohm
R400	24942102	CC, 1k ohm, 1/2W
R401	24366103	CF, 10k ohm
R401	24872391	Chip, 390 ohm, 1/16W
R402	24366333	CF, 33k ohm
R402	24872103	Chip, 10k ohm, 1/16W
R403	24366332	CF, 3300 ohm

Location No.	Part No.	Description
R403	24872302	Chip, 3k ohm, 1/16W
R404	24383270	OMF, 27 ohm, 2W
R405	24382332	OMF, 3300 ohm, 1W
R407	24872103	Chip, 10k ohm, 1/16W
R408	24321209	MF, 2 ohm, 1/2W
R409	24381103	OMF, 10k ohm, 1/2W
R410	24366331	CF, 330 ohm
R411	24366471	CF, 470 ohm
R415	24553272	OMF, 2700 ohm, 1W
R416	24510562	Cement, 5600 ohm, 5W
R421	24872334	Chip, 330k ohm, 1/16W
R422	24872152	Chip, 1500 ohm, 1/16W
R423	24872152	Chip, 1500 ohm, 1/16W
R424	24546338	FR, 0.33 ohm, 1/2W
R425	24552331	OMF, 330 ohm, 1/2W
R425	24872153	Chip, 15k ohm, 1/16W
R426	24366821	CF, 820 ohm
R427	24366432	CF, 4300 ohm
R428	24366561	CF, 560 ohm
R429	24552330	OMF, 33 ohm, 1/2W
R431	24382100	OMF, 10 ohm, 1W
R432	24532560	FR, 56 ohm, 1W
R434	24366102	CF, 1k ohm
R435	24366333	CF, 33k ohm
R436	24327224	MF, 220k ohm, $\pm 1\%$ , 1/4W
R439	24366472	CF, 4700 ohm
R441	24383102	OMF, 1k ohm, 2W
R443	24310109	MF, 1.0 ohm, 1/2W
R444	24338398	MF, 0.39 ohm, 1W
R445	24382332	OMF, 3300 ohm, 1W
R446	24382332	OMF, 3300 ohm, 1W
R447	24382473	OMF, 47k ohm, 1W
R448	24338828	MF, 0.82 ohm, 1W
R450	24066879	VR, 1k ohm, 0.3W
R451	24376223	CF, 22k ohm, 1/2W
R452	24376223	CF, 22k ohm, 1/2W
R453	24376223	CF, 22k ohm, 1/2W
R454	24366223	CF, 22k ohm
R455	24366333	CF, 33k ohm
R460	24552332	OMF, 3300 ohm, 1/2W
R461	24366332	CF, 3300 ohm
R462	24366102	CF, 1k ohm
R462	24366912	CF, 9100 ohm
R463	24339109	MF, 1 ohm, 2W
R464	24366273	CF, 27k ohm
R465	24366114	CF, 110k ohm
R466	24366152	CF, 1500 ohm
R469	24000465	FR, 9.1 ohm, 1W
R472	24552270	OMF, 27 ohm, 1/2W
R476	24366821	CF, 820 ohm
R477	24383121	OMF, 120 ohm, 2W
R478	24376333	CF, 33k ohm, 1/2W
R479	24366101	CF, 100 ohm
R480	24553332	OMF, 3300 ohm, 1W
R481	24366473	CF, 47k ohm
R482	24366103	CF, 10k ohm
R483	24366154	CF, 150k ohm
R484	24366473	CF, 47k ohm
R485	24552271	OMF, 270 ohm, 1/2W
R487	24366472	CF, 4700 ohm
R488	24366474	CF, 470k ohm
R489	24366332	CF, 3300 ohm
R490	24366332	CF, 3300 ohm
R492	24366102	CF, 1k ohm



Location No.	Part No.	Description
R493	24552392	OMF, 3900 ohm, 1/2W
R494	24366183	CF, 18k ohm
R495	24366682	CF, 6800 ohm
R496	24382114	OMF, 110k ohm, 1W
R498	24366153	CF, 15k ohm
R499	24366824	CF, 820k ohm
R501	24872223	Chip, 22k ohm, 1/16W
R502	24872101	Chip, 100 ohm, 1/16W
R503	24872101	Chip, 100 ohm, 1/16W
R505	24872102	Chip, 1k ohm, 1/16W
R506	24872103	Chip, 10k ohm, 1/16W
R508	24872102	Chip, 1k ohm, 1/16W
R509	24872102	Chip, 1k ohm, 1/16W
R510	24872472	Chip, 4700 ohm, 1/16W
R511	24872101	Chip, 100 ohm, 1/16W
R515	24366102	CF, 1k ohm
R516	24366101	CF, 100 ohm
R516	24872101	Chip, 100 ohm, 1/16W
R517	24872101	Chip, 100 ohm, 1/16W
R518	24872472	Chip, 4700 ohm, 1/16W
R519	24872101	Chip, 100 ohm, 1/16W
R520	24872103	Chip, 10k ohm, 1/16W
R521	24872223	Chip, 22k ohm, 1/16W
R522	24872473	Chip, 47k ohm, 1/16W
R532	24000824	Chip, Jumper, 2125 type
R533	24000824	Chip, Jumper, 2125 type
R534	24000824	Chip, Jumper, 2125 type
R601	24366332	CF, 3300 ohm
R602	24366332	CF, 3300 ohm
R603	24366222	CF, 2200 ohm
R604	24366222	CF, 2200 ohm
R605	24366229	CF, 2.2 ohm
R606	24366229	CF, 2.2 ohm
R607	24366682	CF, 6800 ohm
R608	24366682	CF, 6800 ohm
R610	24366104	CF, 100k ohm
R611	24366103	CF, 10k ohm
R612	24366103	CF, 10k ohm
R613	24366224	CF, 220k ohm
R614	24366103	CF, 10k ohm
R635	24366224	CF, 220k ohm
R636	24366104	CF, 100k ohm
R661	24366103	CF, 10k ohm
R670	24552182	OMF, 1800 ohm, 1/2W
R671	24366153	CF, 15k ohm
R672	24366153	CF, 15k ohm
R673	24366563	CF, 56k ohm
R674	24366563	CF, 56k ohm
R675	24366103	CF, 10k ohm
R676	24872223	Chip, 22k ohm, 1/16W
R677	24366104	CF, 100k ohm
R677	24872223	Chip, 22k ohm, 1/16W
R678	24366103	CF, 10k ohm
R678	24872223	Chip, 22k ohm, 1/16W
R679	24366103	CF, 10k ohm
R679	24872223	Chip, 22k ohm, 1/16W
R680	24872223	Chip, 22k ohm, 1/16W
R681	24872223	Chip, 22k ohm, 1/16W
R682	24366473	CF, 47k ohm
R683	24366223	CF, 22k ohm
R684	24366223	CF, 22k ohm
R688	24366222	CF, 2200 ohm
R688	24552391	OMF, 390 ohm, 1/2W
R690	24552391	OMF, 390 ohm, 1/2W

Location No.	Part No.	Description
R690	24872681	Chip, 680 ohm, 1/16W
R691	24872681	Chip, 680 ohm, 1/16W
R692	24872681	Chip, 680 ohm, 1/16W
R693	24872681	Chip, 680 ohm, 1/16W
R701	24872221	Chip, 220 ohm, 1/16W
R702	24872221	Chip, 220 ohm, 1/16W
R703	24872472	Chip, 4700 ohm, 1/16W
R704	24872472	Chip, 4700 ohm, 1/16W
R705	24872472	Chip, 4700 ohm, 1/16W
R706	24872472	Chip, 4700 ohm, 1/16W
R707	24872100	Chip, 10 ohm, 1/16W
R708	24872100	Chip, 10 ohm, 1/16W
R709	24872100	Chip, 10 ohm, 1/16W
R710	24872100	Chip, 10 ohm, 1/16W
R711	24872100	Chip, 10 ohm, 1/16W
R712	24872100	Chip, 10 ohm, 1/16W
R713	24872100	Chip, 10 ohm, 1/16W
R714	24872100	Chip, 10 ohm, 1/16W
R715	24872153	Chip, 15k ohm, 1/16W
R716	24872103	Chip, 10k ohm, 1/16W
R717	24872622	Chip, 6200 ohm, 1/16W
R718	24872152	Chip, 1500 ohm, 1/16W
R720	24872103	Chip, 10k ohm, 1/16W
R721	24872223	Chip, 22k ohm, 1/16W
R722	24872222	Chip, 2200 ohm, 1/16W
R725	24872754	Chip, 750k ohm, 1/16W
R726	24872331	Chip, 330 ohm, 1/16W
R727	24871221	Chip, 220 ohm, 1/8W
R728	24872393	Chip, 39k ohm, 1/16W
R729	24872153	Chip, 15k ohm, 1/16W
R735	24872911	Chip, 910 ohm, 1/16W
R736	24872911	Chip, 910 ohm, 1/16W
R737	24872152	Chip, 1500 ohm, 1/16W
R738	24872332	Chip, 3300 ohm, 1/16W
R739	24872362	Chip, 3600 ohm, 1/16W
R740	24872911	Chip, 910 ohm, 1/16W
R741	24872911	Chip, 910 ohm, 1/16W
R742	24872152	Chip, 1500 ohm, 1/16W
R743	24872332	Chip, 3300 ohm, 1/16W
R744	24872362	Chip, 3600 ohm, 1/16W
R745	24872911	Chip, 910 ohm, 1/16W
R746	24872911	Chip, 910 ohm, 1/16W
R747	24872152	Chip, 1500 ohm, 1/16W
R748	24872332	Chip, 3300 ohm, 1/16W
R749	24872362	Chip, 3600 ohm, 1/16W
R750	24872911	Chip, 910 ohm, 1/16W
R751	24872911	Chip, 910 ohm, 1/16W
R752	24872152	Chip, 1500 ohm, 1/16W
R753	24872332	Chip, 3300 ohm, 1/16W
R754	24872362	Chip, 3600 ohm, 1/16W
R755	24872911	Chip, 910 ohm, 1/16W
R756	24872911	Chip, 910 ohm, 1/16W
R757	24872152	Chip, 1500 ohm, 1/16W
R758	24872332	Chip, 3300 ohm, 1/16W
R759	24872362	Chip, 3600 ohm, 1/16W
R760	24872911	Chip, 910 ohm, 1/16W
R761	24872911	Chip, 910 ohm, 1/16W
R762	24872152	Chip, 1500 ohm, 1/16W
R763	24872332	Chip, 3300 ohm, 1/16W
R764	24872362	Chip, 3600 ohm, 1/16W
R778	24872101	Chip, 100 ohm, 1/16W
R779	24872101	Chip, 100 ohm, 1/16W
R780	24872101	Chip, 100 ohm, 1/16W
R781	24872101	Chip, 100 ohm, 1/16W

Location No.	Part No.	Description
R782	24872101	Chip, 100 ohm, 1/16W
R783	24872101	Chip, 100 ohm, 1/16W
R786	24872472	Chip, 4700 ohm, 1/16W
R787	24872472	Chip, 4700 ohm, 1/16W
R801	24366473	CF, 47k ohm
R802	24366102	CF, 1k ohm
R803	24366683	CF, 68k ohm
R805	24366101	CF, 100 ohm
R806	24366101	CF, 100 ohm
R807	24367273	CF, 27k ohm, $\pm 2\%$
R808	24552470	OMF, 47 ohm, 1/2W
R809	24321689	OMF, 6.8 ohm, 1/2W
R810	24383680	OMF, 68 ohm, 2W
R811	24552121	OMF, 120 ohm, 1/2W
R812	24552390	OMF, 39 ohm, 1/2W
R814	24552821	OMF, 820 ohm, 1/2W
R816	24384223	OMF, 22k ohm, 3W
△ R819	24009954	Metal-Glazed Resistor, 2.2M ohm, 1/2W
R820	24007061	Cement, 1.8 ohm, $\pm 10\%$ , 2W
R821	24510479	Cement, 4.7 ohm, 5W
R822	24366102	CF, 1k ohm
R823	24554470	OMF, 47 ohm, 2W
R851	24545109	FR, 1 ohm, 1/4W
R852	24366272	CF, 2700 ohm
R853	24338568	MF, 0.56 ohm, 1W
R854	24553121	OMF, 120 ohm, 1W
R855	24553271	OMF, 270 ohm, 1W
R856	24366152	CF, 1500 ohm
R857	24381682	OMF, 6800 ohm, 1/2W
R858	24366102	CF, 1k ohm
R859	24382333	OMF, 33k ohm, 1W
R860	24366102	CF, 1k ohm
△ R861	24005015	Metal-Glazed Resistor, 8.2M ohm, 1W
R862	24366223	CF, 22k ohm
R863	24366101	CF, 100 ohm
R870	24552100	OMF, 10 ohm, 1/2W
R901	24366101	CF, 100 ohm
R903	24942102	CC, 1k ohm, 1/2W
R905	24366390	CF, 39 ohm
R906	24366621	CF, 620 ohm
R908	24366680	CF, 68 ohm
R909	24366151	CF, 150 ohm
R911	24366101	CF, 100 ohm
R913	24942102	CC, 1k ohm, 1/2W
R915	24366390	CF, 39 ohm
R916	24366621	CF, 620 ohm
R918	24366680	CF, 68 ohm
R921	24366101	CF, 100 ohm
R923	24942102	CC, 1k ohm, 1/2W
R925	24366151	CF, 150 ohm
R926	24366621	CF, 620 ohm
R928	24366101	CF, 100 ohm
R931	24555153	OMF, 15k ohm, 3W
R932	24555153	OMF, 15k ohm, 3W
R933	24000929	FR, 1.5 ohm, 1W
R935	24366150	CF, 15 ohm
R936	24366330	CF, 33 ohm
R941	24555153	OMF, 15k ohm, 3W
R942	24555153	OMF, 15k ohm, 3W
R943	24366103	CF, 10k ohm
R944	24366150	CF, 15 ohm
R945	24366680	CF, 68 ohm

Location No.	Part No.	Description
R946	24366330	CF, 33 ohm
R949	24366121	CF, 120 ohm
R951	24555153	OMF, 15k ohm, 3W
R952	24555153	OMF, 15k ohm, 3W
R953	24366390	CF, 39 ohm
R956	24366102	CF, 1k ohm
R957	24366330	CF, 33 ohm
R961	24366102	CF, 1k ohm
R962	24366361	CF, 360 ohm
R964	24366332	CF, 3300 ohm
R965	24366471	CF, 470 ohm
R966	24366821	CF, 820 ohm
R967	24366102	CF, 1k ohm
R968	24366680	CF, 68 ohm
R969	24366103	CF, 10k ohm
R970	24366222	CF, 2200 ohm
R971	24367152	CF, 1500 ohm, $\pm 2\%$
R972	24367471	CF, 470 ohm, $\pm 2\%$
R973	24367681	CF, 680 ohm, $\pm 2\%$
R974	24367681	CF, 680 ohm, $\pm 2\%$
R975	24366242	CF, 2400 ohm
R976	24367562	CF, 5600 ohm, $\pm 2\%$
R977	24367472	CF, 4700 ohm, $\pm 2\%$
R978	24367681	CF, 680 ohm, $\pm 2\%$
R6101	24366473	CF, 47k ohm
R6102	24366103	CF, 10k ohm
R6103	24366331	CF, 330 ohm
R7703	24366473	CF, 47k ohm
R7704	24366103	CF, 10k ohm
R7705	24366472	CF, 4700 ohm
R7706	24366222	CF, 2200 ohm
R7707	24366472	CF, 4700 ohm
R7708	24366472	CF, 4700 ohm
R7710	24384680	OMF, 68 ohm, 3W
R7711	24323229	MF, 2.2 ohm, 2W
R7712	24366472	CF, 4700 ohm
R7713	24366472	CF, 4700 ohm
R7715	24384680	OMF, 68 ohm, 3W
R7716	24323229	MF, 2.2 ohm, 2W
R7717	24366472	CF, 4700 ohm
R7718	24366472	CF, 4700 ohm
R7720	24384680	OMF, 68 ohm, 3W
R7721	24323229	MF, 2.2 ohm, 2W
R7722	24366472	CF, 4700 ohm
R7723	24366472	CF, 4700 ohm
R7725	24384680	OMF, 68 ohm, 3W
R7726	24323229	MF, 2.2 ohm, 2W
R7727	24366472	CF, 4700 ohm
R7728	24366472	CF, 4700 ohm
R7730	24384680	OMF, 68 ohm, 3W
R7731	24323229	MF, 2.2 ohm, 2W
R7732	24366472	CF, 4700 ohm
R7733	24366472	CF, 4700 ohm
R7735	24384680	OMF, 68 ohm, 3W
R7736	24323229	MF, 2.2 ohm, 2W
R7738	24383101	OMF, 100 ohm, 2W
R7741	24366471	CF, 470 ohm
R7742	24366472	CF, 4700 ohm
R7743	24366223	CF, 22k ohm
R7744	24366102	CF, 1k ohm
R7745	24366222	CF, 2200 ohm
R7746	24366223	CF, 22k ohm
R7747	24366222	CF, 2200 ohm
R7749	24366331	CF, 330 ohm

Location No.	Part No.	Description
R7750	24323278	MF, 0.27 ohm, 2W
R7751	24366471	CF, 470 ohm
R7752	24366101	CF, 100 ohm
R7753	24366101	CF, 100 ohm
R7754	24366101	CF, 100 ohm
R7755	24366102	CF, 1k ohm
R7757	24366223	CF, 22k ohm
R7758	24366222	CF, 2200 ohm
R7763	24366471	CF, 470 ohm
R7764	24366331	CF, 330 ohm
R7765	24339398	MF, 0.39 ohm, 2W
R7766	24366223	CF, 22k ohm
R7767	24366223	CF, 22k ohm
R7768	24366102	CF, 1k ohm
R7770	24366153	CF, 15k ohm
R7771	24366102	CF, 1k ohm
R7772	24366102	CF, 1k ohm
R7775	24366273	CF, 27k ohm
R7776	24366472	CF, 4700 ohm
R7777	24366273	CF, 27k ohm
R7778	24366472	CF, 4700 ohm
R7779	24366102	CF, 1k ohm
R7780	24366102	CF, 1k ohm
R7781	24366333	CF, 33k ohm
R7782	24339828	MF, 0.82 ohm, 2W
R7783	24366331	CF, 330 ohm
R7784	24366471	CF, 470 ohm
R7785	24366222	CF, 2200 ohm
R7786	24366103	CF, 10k ohm
R7787	24366104	CF, 100k ohm
R7788	24366103	CF, 10k ohm
R7789	24366471	CF, 470 ohm
R7790	24552182	OMF, 1800 ohm, 1/2W
R7791	24552681	OMF, 680 ohm, 1/2W
R7792	24366471	CF, 470 ohm
R7793	24552182	OMF, 1800 ohm, 1/2W
R7794	24366223	CF, 22k ohm
R8301	24366473	CF, 47k ohm
R8302	24366273	CF, 27k ohm
R9601	24366101	CF, 100 ohm
R9602	24366362	CF, 3600 ohm
R9603	24366392	CF, 3900 ohm
R9604	24366272	CF, 2700 ohm
R9605	24366682	CF, 6800 ohm
R9606	24366362	CF, 3600 ohm
R9613	24366560	CF, 56 ohm
R9614	24366560	CF, 56 ohm
R9615	24366101	CF, 100 ohm
R9616	24366102	CF, 1k ohm
RA01	24366102	CF, 1k ohm
RA02	24366102	CF, 1k ohm
RA03	24366102	CF, 1k ohm
RA06	24366102	CF, 1k ohm
RA07	24366102	CF, 1k ohm
RA08	24366102	CF, 1k ohm
RA09	24366102	CF, 1k ohm
RA10	24366102	CF, 1k ohm
RA11	24366102	CF, 1k ohm
RA13	24366102	CF, 1k ohm
RA14	24366102	CF, 1k ohm
RA15	24366103	CF, 10k ohm
RA19	24366331	CF, 330 ohm
RA20	24366102	CF, 1k ohm
RA21	24366102	CF, 1k ohm

Location No.	Part No.	Description
RA22	24366102	CF, 1k ohm
RA24	24366153	CF, 15k ohm
RA31	24366103	CF, 10k ohm
RA32	24366103	CF, 10k ohm
RA36	24366102	CF, 1k ohm
RA37	24366102	CF, 1k ohm
RA53	24366101	CF, 100 ohm
RA55	24366101	CF, 100 ohm
RA57	24366101	CF, 100 ohm
RA59	24366102	CF, 1k ohm
RA61	24366102	CF, 1k ohm
RA62	24366102	CF, 1k ohm
RA63	24366102	CF, 1k ohm
RA70	24366333	CF, 33k ohm
RA71	24366103	CF, 10k ohm
RA71	24366683	CF, 68k ohm
RA72	24366103	CF, 10k ohm
RA72	24366223	CF, 22k ohm
RA73	24366103	CF, 10k ohm
RA75	24366333	CF, 33k ohm
RA76	24366103	CF, 10k ohm
RA77	24366223	CF, 22k ohm
RA78	24366683	CF, 68k ohm
RA91	24366103	CF, 10k ohm
RA92	24366472	CF, 4700 ohm
RA93	24366103	CF, 10k ohm
RA96	24366103	CF, 10k ohm
RA97	24366472	CF, 4700 ohm
RA98	24366103	CF, 10k ohm
RA99	24366562	CF, 5600 ohm
RA104	24366682	CF, 6800 ohm
RA105	24366103	CF, 10k ohm
RA106	24366682	CF, 6800 ohm
RA107	24366472	CF, 4700 ohm
RA108	24366472	CF, 4700 ohm
RA120	24366472	CF, 4700 ohm
RA140	24366153	CF, 15k ohm
RA150	24366103	CF, 10k ohm
RA310	24366101	CF, 100 ohm
RA410	24366273	CF, 27k ohm
RB01	24366271	CF, 270 ohm
RB02	24366471	CF, 470 ohm
RB03	24366101	CF, 100 ohm
RB04	24366223	CF, 22k ohm
RB05	24366223	CF, 22k ohm
RB07	24366271	CF, 270 ohm
RB08	24366271	CF, 270 ohm
RB09	24366470	CF, 47 ohm
RB10	24366101	CF, 100 ohm
RB11	24366103	CF, 10k ohm
RB12	24366471	CF, 470 ohm
RB40	24366103	CF, 10k ohm
RB43	24366822	CF, 8200 ohm
RB44	24366103	CF, 10k ohm
RB45	24366101	CF, 100 ohm
RB81	24366122	CF, 1200 ohm
RB82	24366123	CF, 12k ohm
RB83	24366123	CF, 12k ohm
RB84	24366562	CF, 5600 ohm
RB90	24366392	CF, 3900 ohm
RB91	24366473	CF, 47k ohm
RB92	24366271	CF, 270 ohm
RB93	24366271	CF, 270 ohm
RB94	24366222	CF, 2200 ohm



Location No.	Part No.	Description
RB95	24366222	CF, 2200 ohm
RB96	24366273	CF, 27k ohm
RB97	24366273	CF, 27k ohm
RB98	24366102	CF, 1k ohm
RF01	24872332	Chip, 3300 ohm, 1/16W
RF03	24872682	Chip, 6800 ohm, 1/16W
RF04	24872223	Chip, 22k ohm, 1/16W
RF06	24872102	Chip, 1k ohm, 1/16W
RF08	23103832	Chip (Ferrite Bead), TEM2125M
RF09	23103832	Chip (Ferrite Bead), TEM2125M
RF10	23103832	Chip (Ferrite Bead), TEM2125M
RF11	24872103	Chip, 10k ohm, 1/16W
RF12	24872101	Chip, 100 ohm, 1/16W
RF13	24872101	Chip, 100 ohm, 1/16W
RF14	24872101	Chip, 100 ohm, 1/16W
RF15	24872103	Chip, 10k ohm, 1/16W
RF16	24872471	Chip, 470 ohm, 1/16W
RF20	24872472	Chip, 4700 ohm, 1/16W
RF21	24000824	Chip, Jumper, 2125 type
RF22	24872102	Chip, 1k ohm, 1/16W
RF24	24872102	Chip, 1k ohm, 1/16W
RF26	24872102	Chip, 1k ohm, 1/16W
RF27	24872103	Chip, 10k ohm, 1/16W
RF28	24872102	Chip, 1k ohm, 1/16W
RF29	24872103	Chip, 10k ohm, 1/16W
RF30	24872103	Chip, 10k ohm, 1/16W
RF38	24872153	Chip, 15k ohm, 1/16W
RF39	24872472	Chip, 4700 ohm, 1/16W
RJ02	24872101	Chip, 100 ohm, 1/16W
RQ01	24872102	Chip, 1k ohm, 1/16W
RQ03	24872102	Chip, 1k ohm, 1/16W
RQ04	24872511	Chip, 510 ohm, 1/16W
RQ05	24872471	Chip, 470 ohm, 1/16W
RQ06	24872471	Chip, 470 ohm, 1/16W
RQ07	24872103	Chip, 10k ohm, 1/16W
RQ08	24872102	Chip, 1k ohm, 1/16W
RQ09	24872102	Chip, 1k ohm, 1/16W
RQ10	24872102	Chip, 1k ohm, 1/16W
RQ11	24872561	Chip, 560 ohm, 1/16W
RQ12	24872561	Chip, 560 ohm, 1/16W
RQ13	24872203	Chip, 20k ohm, 1/16W
RQ14	24872273	Chip, 27k ohm, 1/16W
RQ20	24872563	Chip, 56k ohm, 1/16W
RR01	24366102	CF, 1k ohm
RR02	24366104	CF, 100k ohm
RR03	24366222	CF, 2200 ohm
RR04	24366101	CF, 100 ohm
RR04	24872102	Chip, 1k ohm, 1/16W
RR05	24366102	CF, 1k ohm
RR05	24872102	Chip, 1k ohm, 1/16W
RR06	24000824	Chip, Jumper, 2125 type
RR06	24366223	CF, 22k ohm
RR07	24000824	Chip, Jumper, 2125 type
RR07	24366152	CF, 1500 ohm
RR08	24366332	CF, 3300 ohm
RR09	24000824	Chip, Jumper, 2125 type
RR09	24366222	CF, 2200 ohm
RR10	24366102	CF, 1k ohm
RR10	24872103	Chip, 10k ohm, 1/16W
RR11	24366152	CF, 1500 ohm
RR11	24872473	Chip, 47k ohm, 1/16W

Location No.	Part No.	Description
RR12	24366152	CF, 1500 ohm
RR12	24872102	Chip, 1k ohm, 1/16W
RR13	24366152	CF, 1500 ohm
RR13	24872622	Chip, 6200 ohm, 1/16W
RR15	24366391	CF, 390 ohm
RR16	24366391	CF, 390 ohm
RR17	24366391	CF, 390 ohm
RR20	24872103	Chip, 10k ohm, 1/16W
RR22	24366103	CF, 10k ohm
RR23	24366103	CF, 10k ohm
RR24	24000824	Chip, Jumper, 2125 type
RR25	24872102	Chip, 1k ohm, 1/16W
RR28	24872473	Chip, 47k ohm, 1/16W
RR29	24872473	Chip, 47k ohm, 1/16W
RR31	24366331	CF, 330 ohm
RR32	24366331	CF, 330 ohm
RR32	24872331	Chip, 330 ohm, 1/16W
RR33	24366331	CF, 330 ohm
RR33	24872331	Chip, 330 ohm, 1/16W
RR34	24366102	CF, 1k ohm
RR34	24872331	Chip, 330 ohm, 1/16W
RR35	24366392	CF, 3900 ohm
RR36	24366392	CF, 3900 ohm
RR37	24366392	CF, 3900 ohm
RR40	24366102	CF, 1k ohm
RR41	24366332	CF, 3300 ohm
RR48	24366222	CF, 2200 ohm
RR62	24366102	CF, 1k ohm
RR63	24366332	CF, 3300 ohm
RR64	24366152	CF, 1500 ohm
RR65	24366102	CF, 1k ohm
RR66	24366101	CF, 100 ohm
RR67	24366271	CF, 270 ohm
RR68	24366332	CF, 3300 ohm
RR69	24366152	CF, 1500 ohm
RR70	24366102	CF, 1k ohm
RR71	24366332	CF, 3300 ohm
RR72	24366332	CF, 3300 ohm
RR73	24366332	CF, 3300 ohm
RR81	24366271	CF, 270 ohm
RR82	24366101	CF, 100 ohm
RR83	24366271	CF, 270 ohm
RR84	24366101	CF, 100 ohm
RR85	24366102	CF, 1k ohm
RR86	24366152	CF, 1500 ohm
RR87	24366332	CF, 3300 ohm
RR88	24366101	CF, 100 ohm
RR99	24366473	CF, 47k ohm
RS01	24872681	Chip, 680 ohm, 1/16W
RS02	24872681	Chip, 680 ohm, 1/16W
RS03	24872101	Chip, 100 ohm, 1/16W
RS04	24872101	Chip, 100 ohm, 1/16W
RS05	24872472	Chip, 4700 ohm, 1/16W
RS06	24872472	Chip, 4700 ohm, 1/16W
RS07	24872472	Chip, 4700 ohm, 1/16W
RS08	24872472	Chip, 4700 ohm, 1/16W
RS09	24872472	Chip, 4700 ohm, 1/16W
RS10	24872472	Chip, 4700 ohm, 1/16W
RS13	24872101	Chip, 100 ohm, 1/16W
RS14	24872101	Chip, 100 ohm, 1/16W
RS15	24872104	Chip, 100k ohm, 1/16W
RS16	24872104	Chip, 100k ohm, 1/16W
RS17	24872223	Chip, 22k ohm, 1/16W
RS18	24872223	Chip, 22k ohm, 1/16W

Location No.	Part No.	Description
RS19	24872681	Chip, 680 ohm, 1/16W
RS20	24872681	Chip, 680 ohm, 1/16W
RS21	24872222	Chip, 2200 ohm, 1/16W
RS22	24872222	Chip, 2200 ohm, 1/16W
RS23	24872101	Chip, 100 ohm, 1/16W
RS24	24872101	Chip, 100 ohm, 1/16W
RS27	24872104	Chip, 100k ohm, 1/16W
RS28	24872104	Chip, 100k ohm, 1/16W
RS29	24872223	Chip, 22k ohm, 1/16W
RS30	24872223	Chip, 22k ohm, 1/16W
RS31	24872103	Chip, 10k ohm, 1/16W
RS32	24872104	Chip, 100k ohm, 1/16W
RS35	24872223	Chip, 22k ohm, 1/16W
RS36	24872223	Chip, 22k ohm, 1/16W
RS37	24872104	Chip, 100k ohm, 1/16W
RS38	24872104	Chip, 100k ohm, 1/16W
RS43	24872681	Chip, 680 ohm, 1/16W
RS44	24872681	Chip, 680 ohm, 1/16W
RS56	24872102	Chip, 1k ohm, 1/16W
RS57	24872223	Chip, 22k ohm, 1/16W
RS58	24872223	Chip, 22k ohm, 1/16W
RS59	24872681	Chip, 680 ohm, 1/16W
RS60	24872102	Chip, 1k ohm, 1/16W
RV01	24872101	Chip, 100 ohm, 1/16W
RV02	24872101	Chip, 100 ohm, 1/16W
RV03	24872101	Chip, 100 ohm, 1/16W
RV04	24872101	Chip, 100 ohm, 1/16W
RV05	24872101	Chip, 100 ohm, 1/16W
RV06	24872101	Chip, 100 ohm, 1/16W
RV07	24872162	Chip, 1600 ohm, 1/16W
RV08	24872162	Chip, 1600 ohm, 1/16W
RV09	24872101	Chip, 100 ohm, 1/16W
RV10	24872101	Chip, 100 ohm, 1/16W
RV12	24872681	Chip, 680 ohm, 1/16W
RV13	24872681	Chip, 680 ohm, 1/16W
RV16	24872271	Chip, 270 ohm, 1/16W
RV18	24872123	Chip, 12k ohm, 1/16W
RV19	24872101	Chip, 100 ohm, 1/16W
RV20	24872101	Chip, 100 ohm, 1/16W
RV21	24872151	Chip, 150 ohm, 1/16W
RV23	24552101	OMF, 100 ohm, 1/2W
RV25	24872101	Chip, 100 ohm, 1/16W
RV26	24366181	CF, 180 ohm
RV27	24872750	Chip, 75 ohm, 1/16W
RV28	24872683	Chip, 68k ohm, 1/16W
RV29	24872273	Chip, 27k ohm, 1/16W
RV30	24872750	Chip, 75 ohm, 1/16W
RV31	24872750	Chip, 75 ohm, 1/16W
RV32	24872750	Chip, 75 ohm, 1/16W
RV33	24872123	Chip, 12k ohm, 1/16W
RV34	24872123	Chip, 12k ohm, 1/16W
RV35	24872103	Chip, 10k ohm, 1/16W
RV36	24872101	Chip, 100 ohm, 1/16W
RV37	24872750	Chip, 75 ohm, 1/16W
RV60	24366681	CF, 680 ohm
RV60	24872102	Chip, 1k ohm, 1/16W
RV61	24366681	CF, 680 ohm
RV61	24552101	OMF, 100 ohm, 1/2W
RV62	24872101	Chip, 100 ohm, 1/16W
RV63	24552151	OMF, 150 ohm, 1/2W
RV64	24872750	Chip, 75 ohm, 1/16W
RV65	24552101	OMF, 100 ohm, 1/2W
RV66	24872101	Chip, 100 ohm, 1/16W
RV67	24552151	OMF, 150 ohm, 1/2W

Location No.	Part No.	Description
RV68	24872750	Chip, 75 ohm, 1/16W
RV70	24872101	Chip, 100 ohm, 1/16W
RV71	24872472	Chip, 4700 ohm, 1/16W
RV73	24872103	Chip, 10k ohm, 1/16W
RV74	24872104	Chip, 100k ohm, 1/16W
RV78	24872100	Chip, 10 ohm, 1/16W
RV79	24872102	Chip, 1k ohm, 1/16W
RV80	24872271	Chip, 270 ohm, 1/16W
RV81	24872750	Chip, 75 ohm, 1/16W
RV82	24872101	Chip, 100 ohm, 1/16W
RV85	24872750	Chip, 75 ohm, 1/16W
RV86	24872750	Chip, 75 ohm, 1/16W
RV87	24872750	Chip, 75 ohm, 1/16W
RV89	24872750	Chip, 75 ohm, 1/16W
RV90	24872681	Chip, 680 ohm, 1/16W
RV91	24872681	Chip, 680 ohm, 1/16W
RV92	24872100	Chip, 10 ohm, 1/16W
RV93	24872104	Chip, 100k ohm, 1/16W
RV94	24872103	Chip, 10k ohm, 1/16W
RV95	24872472	Chip, 4700 ohm, 1/16W
RV97	24872101	Chip, 100 ohm, 1/16W
RV800	24366100	CF, 10 ohm
RV801	24366222	CF, 2200 ohm
RW02	24366271	CF, 270 ohm
RW02	24872563	Chip, 56k ohm, 1/16W
RW03	24872393	Chip, 39k ohm, 1/16W
RW04	24872560	Chip, 56 ohm, 1/16W
RW05	24872102	Chip, 1k ohm, 1/16W
RW06	24872151	Chip, 150 ohm, 1/16W
RW07	24872222	Chip, 2200 ohm, 1/16W
RW08	24872821	Chip, 820 ohm, 1/16W
RW09	24366563	CF, 56k ohm
RW09	24872560	Chip, 56 ohm, 1/16W
RW10	24872152	Chip, 1500 ohm, 1/16W
RW11	24872561	Chip, 560 ohm, 1/16W
RW12	24872272	Chip, 2700 ohm, 1/16W
RW13	24366393	CF, 39k ohm
RW13	24872821	Chip, 820 ohm, 1/16W
RW14	24552121	OMF, 120 ohm, 1/2W
RW14	24872560	Chip, 56 ohm, 1/16W
RW15	24366223	CF, 22k ohm
RW15	24872152	Chip, 1500 ohm, 1/16W
RW16	24366273	CF, 27k ohm
RW16	24872561	Chip, 560 ohm, 1/16W
RW17	24366333	CF, 33k ohm
RW17	24872272	Chip, 2700 ohm, 1/16W
RW18	24366101	CF, 100 ohm
RW18	24872821	Chip, 820 ohm, 1/16W
RW19	24366100	CF, 10 ohm
RW20	24366392	CF, 3900 ohm
RW20	24872101	Chip, 100 ohm, 1/16W
RW21	24872102	Chip, 1k ohm, 1/16W
RW22	24366102	CF, 1k ohm
RW22	24872101	Chip, 100 ohm, 1/16W
RW23	24366471	CF, 470 ohm
RW23	24872821	Chip, 820 ohm, 1/16W
RW24	24366470	CF, 47 ohm
RW24	24872821	Chip, 820 ohm, 1/16W
RW25	24366182	CF, 1800 ohm
RW25	24872101	Chip, 100 ohm, 1/16W
RW26	24872101	Chip, 100 ohm, 1/16W
RW27	24872102	Chip, 1k ohm, 1/16W
RW28	24872271	Chip, 270 ohm, 1/16W
RW29	24872392	Chip, 3900 ohm, 1/16W

Location No.	Part No.	Description
RW30	24552100	OMF, 10 ohm, 1/2W
RW30	24872152	Chip, 1500 ohm, 1/16W
RW31	24552331	OMF, 330 ohm, 1/2W
RW31	24872101	Chip, 100 ohm, 1/16W
RW32	24366820	CF, 82 ohm
RW32	24872101	Chip, 100 ohm, 1/16W
RW33	24366683	CF, 68k ohm
RW33	24872102	Chip, 1k ohm, 1/16W
RW34	24366820	CF, 82 ohm
RW34	24872271	Chip, 270 ohm, 1/16W
RW35	24366683	CF, 68k ohm
RW35	24872392	Chip, 3900 ohm, 1/16W
RW36	24366330	CF, 33 ohm
RW36	24872152	Chip, 1500 ohm, 1/16W
RW37	24366152	CF, 1500 ohm
RW37	24872101	Chip, 100 ohm, 1/16W
RW38	24366102	CF, 1k ohm
RW39	24366152	CF, 1500 ohm
RW40	24366330	CF, 33 ohm
RW41	24366279	CF, 2.7 ohm
RW41	24872101	Chip, 100 ohm, 1/16W
RW42	24366279	CF, 2.7 ohm
RW42	24872101	Chip, 100 ohm, 1/16W
RW43	24554221	OMF, 220 ohm, 2W
RW43	24872182	Chip, 1800 ohm, 1/16W
RW44	24366122	CF, 1200 ohm
RW44	24872181	Chip, 180 ohm, 1/16W
RW45	24366122	CF, 1200 ohm
RW46	24872101	Chip, 100 ohm, 1/16W
RW47	24872222	Chip, 2200 ohm, 1/16W
RW60	24000824	Chip, Jumper, 2125 type
RW61	24872472	Chip, 4700 ohm, 1/16W
RW62	24872622	Chip, 6200 ohm, 1/16W
RW63	24872101	Chip, 100 ohm, 1/16W
RW64	24872101	Chip, 100 ohm, 1/16W
RW65	24872101	Chip, 100 ohm, 1/16W
RW66	24872681	Chip, 680 ohm, 1/16W
RW67	24872222	Chip, 2200 ohm, 1/16W
RW68	24872222	Chip, 2200 ohm, 1/16W
RW69	24872222	Chip, 2200 ohm, 1/16W
RW70	24872333	Chip, 33k ohm, 1/16W
RW71	24872182	Chip, 1800 ohm, 1/16W
RW72	24872182	Chip, 1800 ohm, 1/16W
RW73	24872103	Chip, 10k ohm, 1/16W
RW74	24872332	Chip, 3300 ohm, 1/16W
RW76	24872182	Chip, 1800 ohm, 1/16W
RW77	24000824	Chip, Jumper, 2125 type
RW78	24000824	Chip, Jumper, 2125 type
RW79	24000824	Chip, Jumper, 2125 type
RW80	24872331	Chip, 330 ohm, 1/16W
RW81	24872331	Chip, 330 ohm, 1/16W
RW82	24872102	Chip, 1k ohm, 1/16W
RW83	24872103	Chip, 10k ohm, 1/16W
RW84	24872102	Chip, 1k ohm, 1/16W
RW85	24000824	Chip, Jumper, 2125 type
RW89	24872102	Chip, 1k ohm, 1/16W
RW90	24000824	Chip, Jumper, 2125 type
RW91	24872103	Chip, 10k ohm, 1/16W
RW92	24872103	Chip, 10k ohm, 1/16W
RW93	24872101	Chip, 100 ohm, 1/16W
RW94	24872101	Chip, 100 ohm, 1/16W
RW95	24872101	Chip, 100 ohm, 1/16W
RW96	24872102	Chip, 1k ohm, 1/16W
RW100	24872563	Chip, 56k ohm, 1/16W

Location No.	Part No.	Description
RW101	24872393	Chip, 39k ohm, 1/16W
RW102	24872563	Chip, 56k ohm, 1/16W
RW103	24872393	Chip, 39k ohm, 1/16W
RW104	24872682	Chip, 6800 ohm, 1/16W
RW105	24872392	Chip, 3900 ohm, 1/16W
RW107	24872103	Chip, 10k ohm, 1/16W
RW108	24872333	Chip, 33k ohm, 1/16W
RW109	24872103	Chip, 10k ohm, 1/16W
RW110	24872333	Chip, 33k ohm, 1/16W
RW114	24872563	Chip, 56k ohm, 1/16W
RW116	24872222	Chip, 2200 ohm, 1/16W
RZ01	24872102	Chip, 1k ohm, 1/16W
RZ02	24872102	Chip, 1k ohm, 1/16W
RZ03	24872332	Chip, 3300 ohm, 1/16W
RZ04	24872102	Chip, 1k ohm, 1/16W
RZ05	24872221	Chip, 220 ohm, 1/16W
RZ06	24872821	Chip, 820 ohm, 1/16W
RZ07	24872101	Chip, 100 ohm, 1/16W
RZ08	24872471	Chip, 470 ohm, 1/16W
RZ09	24872101	Chip, 100 ohm, 1/16W
RZ10	24872222	Chip, 2200 ohm, 1/16W
RZ11	24872101	Chip, 100 ohm, 1/16W
RZ12	24872102	Chip, 1k ohm, 1/16W
RZ13	24872102	Chip, 1k ohm, 1/16W
RZ14	24872102	Chip, 1k ohm, 1/16W
RZ15	24872102	Chip, 1k ohm, 1/16W
RZ17	24872221	Chip, 220 ohm, 1/16W
RZ18	24872471	Chip, 470 ohm, 1/16W
RZ19	24872102	Chip, 1k ohm, 1/16W
RZ20	24872101	Chip, 100 ohm, 1/16W
RZ22	24872222	Chip, 2200 ohm, 1/16W
RZ29	24872331	Chip, 330 ohm, 1/16W
RZ30	24872331	Chip, 330 ohm, 1/16W
<b>COILS &amp; TRANSFORMERS</b>		
L101	23221803	Coil, Choke, TLN3040D
L200	23289479	Coil, Peaking, TRF44R7AF
L201	23289100	Coil, Peaking, TRF4100AF
L301	23103859	Coil (Ferrite Bead), TEM2011
L303	23237975	Coil, Peaking, TRF4101AC
L333	23238702	Coil, Peaking, TRF4101AJ
L400	23289101	Coil, Peaking, TRF4101AF
L441	23233977	Coil, Linearity, TLN2203AG
L441A	23960136	Adhesive, TSE3843-W
L442	23248186	Coil, Choke, TLN3346AD
L461	23248115	Coil, Choke, TLN3367D
△L462	23231220	Deflection Yoke, TDY707JT(R)
△L463	23231220	Deflection Yoke, TDY707JT(R)
△L464	23231220	Deflection Yoke, TDY707JT(R)
L465	23103880	Coil (Ferrite Bead), TEM2011Y
L472	23102441	Magnet, MAG-1094
L473	23102441	Magnet, MAG-1094
L474	23102441	Magnet, MAG-1094
L501	23289100	Coil, Peaking, TRF4100AF
L503	23289470	Coil, Peaking, TRF4470AF
L510	23238718	Coil, Peaking, TRF4479AJ
L512	23103845	Coil, TEM2030AY
L513	23103845	Coil, TEM2030AY
L676	23103832	Chip (Ferrite Bead), TEM2125M
L677	23103832	Chip (Ferrite Bead), TEM2125M
L682	23103832	Chip (Ferrite Bead), TEM2125M

Location No.	Part No.	Description
L683	23103832	Chip (Ferrite Bead), TEM2125M
L684	23289109	Coil, Peaking, TRF41R0AF
L685	23289109	Coil, Peaking, TRF41R0AF
L701	23238562	Coil, Peaking, TRF4109AJ
L702	23238562	Coil, Peaking, TRF4109AJ
L707	23238562	Coil, Peaking, TRF4109AJ
L708	23238562	Coil, Peaking, TRF4109AJ
L709	23238562	Coil, Peaking, TRF4109AJ
L710	23238562	Coil, Peaking, TRF4109AJ
L711	23238562	Coil, Peaking, TRF4109AJ
L712	23238562	Coil, Peaking, TRF4109AJ
L713	23238562	Coil, Peaking, TRF4109AJ
L714	23238562	Coil, Peaking, TRF4109AJ
L719	23232878	Coil, Variable, TRF3503K
L720	23289102	Coil, Peaking, TRF4102AJ
L721	23237805	Coil, Peaking, TRF4222
L722	23289102	Coil, Peaking, TRF4102AJ
L723	23237805	Coil, Peaking, TRF4222
L724	23289102	Coil, Peaking, TRF4102AJ
L725	23237805	Coil, Peaking, TRF4222
L726	23289102	Coil, Peaking, TRF4102AJ
L727	23237805	Coil, Peaking, TRF4222
L728	23289102	Coil, Peaking, TRF4102AJ
L729	23237805	Coil, Peaking, TRF4222
L730	23289102	Coil, Peaking, TRF4102AJ
L731	23237805	Coil, Peaking, TRF4222
L737	23289560	Coil, Peaking, TRF4560AF
L738	23289560	Coil, Peaking, TRF4560AF
L739	23289560	Coil, Peaking, TRF4560AF
L740	23289560	Coil, Peaking, TRF4560AF
L742	23103866	Chip (Ferrite Bead), TEM2105T
L743	23103866	Chip (Ferrite Bead), TEM2105T
L744	23103866	Chip (Ferrite Bead), TEM2105T
L745	23103866	Chip (Ferrite Bead), TEM2105T
L746	23103866	Chip (Ferrite Bead), TEM2105T
L747	23103866	Chip (Ferrite Bead), TEM2105T
L748	23103866	Chip (Ferrite Bead), TEM2105T
L749	23103866	Chip (Ferrite Bead), TEM2105T
L801	23248213	Coil, Choke, TLN3481AH
L802	23248213	Coil, Choke, TLN3481AH
L803	23103859	Coil (Ferrite Bead), TEM2011
L804	23103859	Coil (Ferrite Bead), TEM2011
L853	23248035	Coil, Choke, TLN3278D
L854	23248073	Coil, Choke, TLN3299D
L855	23248073	Coil, Choke, TLN3299D
L856	23248073	Coil, Choke, TLN3299D
L857	23248073	Coil, Choke, TLN3299D
L858	23103859	Coil (Ferrite Bead), TEM2011
L859	23103859	Coil (Ferrite Bead), TEM2011
L860	23280022	Coil, Peaking, TRF4101AZ
L861	23103859	Coil (Ferrite Bead), TEM2011
L862	23248073	Coil, Choke, TLN3299D
L863	23103859	Coil (Ferrite Bead), TEM2011
L864	23103859	Coil (Ferrite Bead), TEM2011
L865	23103859	Coil (Ferrite Bead), TEM2011
L866	23248073	Coil, Choke, TLN3299D
L867	70211045	Coil, Choke, 0.02mH
L868	23103859	Coil (Ferrite Bead), TEM2011
L869	23103859	Coil (Ferrite Bead), TEM2011
L870	23248073	Coil, Choke, TLN3299D
L871	23248073	Coil, Choke, TLN3299D
L872	23248035	Coil, Choke, TLN3278D
L892	23238506	Coil, Peaking, TRF4229AJ

Location No.	Part No.	Description
L893	23238714	Coil, Peaking, TRF4100AJ
L911	23237987	Coil, Peaking, TRF4100AC
L961	23289100	Coil, Peaking, TRF4100AF
L962	23237991	Coil, Peaking, TRF4479AC
L963	23237975	Coil, Peaking, TRF4101AC
L6101	23103859	Coil (Ferrite Bead), TEM2011
L7701	23103859	Coil (Ferrite Bead), TEM2011
L7702	23103859	Coil (Ferrite Bead), TEM2011
L7703	23103859	Coil (Ferrite Bead), TEM2011
L7704	23103859	Coil (Ferrite Bead), TEM2011
L7705	23103859	Coil (Ferrite Bead), TEM2011
L7706	23103859	Coil (Ferrite Bead), TEM2011
LA01	23289100	Coil, Peaking, TRF4100AF
LC05	23238562	Coil, Peaking, TRF4109AJ
LC06	23103859	Coil (Ferrite Bead), TEM2011
LF01	23103775	Coil (Ferrite Bead), TEM2014
LF02	24366100	CF, 10 ohm
LF03	24366100	CF, 10 ohm
LF04	24366100	CF, 10 ohm
LF05	23238506	Coil, Peaking, TRF4229AJ
LF06	23238562	Coil, Peaking, TRF4109AJ
LF07	23238562	Coil, Peaking, TRF4109AJ
LF08	23238714	Coil, Peaking, TRF4100AJ
LF09	23238714	Coil, Peaking, TRF4100AJ
LF10	23238562	Coil, Peaking, TRF4109AJ
LF11	23289109	Coil, Peaking, TRF41R0AF
LF12	23289100	Coil, Peaking, TRF4100AF
LF13	23289100	Coil, Peaking, TRF4100AF
LF17	23289100	Coil, Peaking, TRF4100AF
LQ01	23238709	Coil, Peaking, TRF4270AJ
LQ02	23237991	Coil, Peaking, TRF4479AC
LQ03	23237991	Coil, Peaking, TRF4479AC
LQ04	23238718	Coil, Peaking, TRF4479AJ
LR01	23289100	Coil, Peaking, TRF4100AF
LR01	23289109	Coil, Peaking, TRF41R0AF
LR02	23289109	Coil, Peaking, TRF41R0AF
LR25	23103845	Coil, TEM2030AY
LR26	23103845	Coil, TEM2030AY
LS02	23103859	Coil (Ferrite Bead), TEM2011
LS45	23103832	Chip (Ferrite Bead), TEM2125M
LS46	23103832	Chip (Ferrite Bead), TEM2125M
LV06	23103832	Chip (Ferrite Bead), TEM2125M
LV07	23103832	Chip (Ferrite Bead), TEM2125M
LV08	23289330	Coil, Peaking, TRF4330AF
LV09	23289100	Coil, Peaking, TRF4100AF
LV10	23289220	Coil, Peaking, TRF4220AF
LV11	23289330	Coil, Peaking, TRF4330AF
LV42	23289100	Coil, Peaking, TRF4100AF
LV43	23289100	Coil, Peaking, TRF4100AF
LV47	23238562	Coil, Peaking, TRF4109AJ
LW01	23103806	Chip (Ferrite Bead), TEM2114T
LW02	23103806	Chip (Ferrite Bead), TEM2114T
LW02	23261974	Coil, Choke, HC5-035
LW03	23103806	Chip (Ferrite Bead), TEM2114T
LW04	23103859	Coil (Ferrite Bead), TEM2011
LW04	24000824	Chip Jumper, 2125 Type
LW05	23103822	Chip (Ferrite Bead), TEM2117T
LW05	23103859	Coil (Ferrite Bead), TEM2011
LW06	23103822	Chip (Ferrite Bead), TEM2117T
LW07	23103822	Chip (Ferrite Bead), TEM2117T



Location No.	Part No.	Description
LW08	23289100	Coil, Peaking, TRF4100AF
LW09	23103822	Chip (Ferrite Bead), TEM2117T
LW10	23103806	Chip (Ferrite Bead), TEM2114T
LW12	23238718	Coil, Peaking, TRF4479AJ
LW13	23238702	Coil, Peaking, TRF4101AJ
LW14	23238702	Coil, Peaking, TRF4101AJ
LW15	23238718	Coil, Peaking, TRF4479AJ
LW16	23238718	Coil, Peaking, TRF4479AJ
LW17	23238718	Coil, Peaking, TRF4479AJ
LW41	23103806	Chip (Ferrite Bead), TEM2114T
LW42	23103806	Chip (Ferrite Bead), TEM2114T
LW80	23238562	Coil, Peaking, TRF4109AJ
LW81	23238562	Coil, Peaking, TRF4109AJ
LZ01	23238710	Coil, Peaking, TRF4220AJ
LZ02	23238714	Coil, Peaking, TRF4100AJ
LZ03	23238714	Coil, Peaking, TRF4100AJ
LZ04	23238708	Coil, Peaking, TRF4330AJ
LZ05	23238709	Coil, Peaking, TRF4270AJ
LZ08	23238707	Coil, Peaking, TRF4390AJ
LZ09	70131060	Baze Filter, ZBF253D-00
LZ10	70131060	Baze Filter, ZBF253D-00
T400	23224364	Transformer, Focus, TLN2168AH
T401	23224367	Transformer, Horiz. Drive, TLN1098AH
△T461	23236552	Transformer, Flyback, TFB3078BD
△T461A	23192917	Anode Cap, TCCP5149
T461B	23960136	Adhesive, TSE3843-W
T461Z	23236508	Transformer, Flyback, TFB3078ZD
T801	23211670	Line Filter, TRF3164G
△T803	23217432	Transformer, Power, TPW1562AZ
T804	23217361	Transformer, Choke, TPW2009AZ
T805	23217413	Transformer, Choke, TPW2015AZ
△T862	23217433	Transformer, Converter, TPW3426AS
<b>SEMICONDUCTORS</b>		
Q201	A6335470	Transistor, 2SC2712-Y
Q202	A6541130	Transistor, 2SA1162-Y
Q203	A6541130	Transistor, 2SA1162-Y
Q204	A6541130	Transistor, 2SA1162-Y
Q205	A6541130	Transistor, 2SA1162-Y
Q261	A6335470	Transistor, 2SC2712-Y
Q262	A6541130	Transistor, 2SA1162-Y
Q270	A6004040	Transistor, RN1404
Q271	A6004040	Transistor, RN1404
Q272	A6014040	Transistor, RN2404
Q273	A6335470	Transistor, 2SC2712-Y
Q281	23904943	IC, MM1111XS
Q282	A6534040	Transistor, 2SA1015-Y
Q291	A6330069	Transistor, 2CS2482 FA-1
Q295	A6317440	Transistor, 2SC1815-Y
Q301	23319787	IC, LA7833S
Q301B	70391355	Screw, BITTB3X8 SZN
Q302	B0385853	IC, TA1241AN
Q330	A6317440	Transistor, 2SC1815-Y
Q331	A6534040	Transistor, 2SA1015-Y
Q352	A6002030	Transistor, RN1203
Q353	A6002030	Transistor, RN1203

Location No.	Part No.	Description
Q354	A6534145	Transistor, 2SA1020-Y(C)
Q360	B0350510	IC, TA75558S
Q361	23314548	Transistor, 2SC4256
Q370	A6534040	Transistor, 2SA1015-Y
Q371	A6534145	Transistor, 2SA1020-Y(C)
Q372	A6002030	Transistor, RN1203
Q402	A6330069	Transistor, 2CS2482 FA-1
Q404	A6873777	Transistor, 2SD2553
Q404B	72471082	Screw, BRDT2W3X10 SZN
Q420	23314141	Transistor, 2SC3852
Q420B	70391356	Screw, BITTB3X10 SZN
Q421	A6317440	Transistor, 2SC1815-Y
Q430	23314707	Transistor, 2SD1944, H
Q460	A6625365	Transistor, 2SB688-O(BS)
Q460B	72471082	Screw, BRDT2W3X10 SZN
Q461	A6317440	Transistor, 2SC1815-Y
Q462	A6317440	Transistor, 2SC1815-Y
Q470	A6317440	Transistor, 2SC1815-Y
Q480	23314246	Transistor, 2SC2023 LF-4
Q483	B0345651	IC, TA7508P(J)
Q491	A6734590	Transistor, 2SC752(G)TM-Y
Q501	B0386208	IC, TA1276AN
Q502	A6335470	Transistor, 2SC2712-Y
Q503	A6541130	Transistor, 2SA1162-Y
Q504	A6335470	Transistor, 2SC2712-Y
Q518	A6335470	Transistor, 2SC2712-Y
Q601	23318413	IC, LA4282
Q611	A6534040	Transistor, 2SA1015-Y
Q612	A6534040	Transistor, 2SA1015-Y
Q622	A6317440	Transistor, 2SC1815-Y
Q671	B0350000	IC, TA75458P
Q681	A6342200	Transistor, 2CS2878-A
Q682	A6342200	Transistor, 2CS2878-A
Q701	B0588213	IC, T7K64(Z)
Q703	23905014	IC, LC78816M
Q704	23905014	IC, LC78816M
Q705	23905014	IC, LC78816M
Q707	B0379550	IC, TA8667P
Q709	A6734590	Transistor, 2SC752(G)TM-Y
Q710	23314204	Transistor, 2SC2412K, Q
Q711	23905666	IC, AT24C1610PC
Q712	23905666	IC, AT24C1610PC
Q713	23905666	IC, AT24C1610PC
Q714	23318977	IC, MC14052BFEL
Q715	23319808	IC, M5218AP
Q717	23319808	IC, M5218AP
Q719	23319808	IC, M5218AP
Q751	23905094	IC, STR392-110
Q752	23905094	IC, STR392-110
Q754	23904521	IC, AN7805
Q754B	70391356	Screw, BITTB3X10 SZN
Q755	23904525	IC, AN7809
Q755B	70391356	Screw, BITTB3X10 SZN
Q756	23318841	IC, AN79M09F
Q756B	70391356	Screw, BITTB3X10 SZN
Q757	A6317440	Transistor, 2SC1815-Y
Q758	A6317440	Transistor, 2SC1815-Y
Q759	A6534040	Transistor, 2SA1015-Y
Q760	23314141	Transistor, 2SC3852
Q760B	70391356	Screw, BITTB3X10 SZN
Q761	A6534040	Transistor, 2SA1015-Y
Q762	A6317440	Transistor, 2SC1815-Y
Q764	B0487045	IC, TC74HC4049AP
Q765	A6317440	Transistor, 2SC1815-Y

Location No.	Part No.	Description
Q766	A6317440	Transistor, 2SC1815-Y
Q767	B0470188	IC, TC4066BP(N)
Q768	A6534040	Transistor, 2SA1015-Y
Q769	A6317440	Transistor, 2SC1815-Y
Q770	A6534040	Transistor, 2SA1015-Y
Q771	A6533730	Transistor, 2SA1012-Y
Q771B	23035308	Screw, BTB3X8SZN
Q771C	23960136	Adhesive, TSE3843-W
Q772	A6534040	Transistor, 2SA1015-Y
Q773	A6317440	Transistor, 2SC1815-Y
Q801	23906540	IC, STR-Z4267
Q810	23906689	IC, PQ05RR11
Q810B	70391355	Screw, BITTB3X8 SZN
Q811	A6002050	Transistor, RN1205
Q812	A6317440	Transistor, 2SC1815-Y
Q821	A6002010	Transistor, RN1201
Q831	23319941	IC, SI-3050C
Q831B	70391356	Screw, BITTB3X10 SZN
Q833	23905977	IC, PQ09RD11
Q833B	70391356	Screw, BITTB3X10 SZN
△ Q862	A8643112	Photo Coupler, TLP621(GRL-L
Q901	A6372621	Transistor, 2SC5360
Q902	A6317440	Transistor, 2SC1815-Y
Q911	A6372621	Transistor, 2SC5360
Q913	A6317440	Transistor, 2SC1815-Y
Q914	A6321240	Transistor, 2SC2120-Y
Q921	A6372621	Transistor, 2SC5360
Q922	A6317440	Transistor, 2SC1815-Y
Q961	A6317440	Transistor, 2SC1815-Y
Q962	A6509140	Transistor, 2SA562TM-Y
Q963	A6317440	Transistor, 2SC1815-Y
Q964	A6534040	Transistor, 2SA1015-Y
Q965	A6317440	Transistor, 2SC1815-Y
Q966	A6534040	Transistor, 2SA1015-Y
Q6101	A6317440	Transistor, 2SC1815-Y
Q9601	A6534040	Transistor, 2SA1015-Y
Q9602	A6534040	Transistor, 2SA1015-Y
Q9605	A6317440	Transistor, 2SC1815-Y
Q9606	A6534040	Transistor, 2SA1015-Y
QA01	23000389	IC, CXP750010-126S
QA02	23905666	IC, AT24C1610PC
QA03	A6534040	Transistor, 2SA1015-Y
QA91	A6317440	Transistor, 2SC1815-Y
QA92	A6534040	Transistor, 2SA1015-Y
QB01	A6534040	Transistor, 2SA1015-Y
QB03	A6002050	Transistor, RN1205
QB03	A6534040	Transistor, 2SA1015-Y
QB04	A6534040	Transistor, 2SA1015-Y
QB81	A6342200	Transistor, 2CS2878-A
QB82	A6342200	Transistor, 2CS2878-A
QB83	A6534040	Transistor, 2SA1015-Y
QB92	A6317440	Transistor, 2SC1815-Y
QB93	A6534040	Transistor, 2SA1015-Y
QB94	A6534040	Transistor, 2SA1015-Y
QB95	A6534040	Transistor, 2SA1015-Y
QB96	A6534040	Transistor, 2SA1015-Y
QF01	23000258	IC, SDA5273-3S
QF02	23314204	Transistor, 2SC2412K, Q
QF03	23314204	Transistor, 2SC2412K, Q
QF04	A6734590	Transistor, 2SC752(G)TM-Y
QF06	23314204	Transistor, 2SC2412K, Q
QF11	23906367	IC, PST9146NL
QQ01	B0385755	IC, TA1229N
QQ02	B0383881	IC, TA8772AN

Location No.	Part No.	Description
QQ03	A6335470	Transistor, 2SC2712-Y
QQ04	A6335470	Transistor, 2SC2712-Y
QR01	23000123	IC, MB90096-192
QR01	B0386235	IC, TA1287P
QR03	23114530	Transistor, 2SA933S-Q
QR05	A6317440	Transistor, 2SC1815-Y
QR21	A6335470	Transistor, 2SC2712-Y
QR24	A6335470	Transistor, 2SC2712-Y
QR35	A6317440	Transistor, 2SC1815-Y
QR36	A6317440	Transistor, 2SC1815-Y
QR37	A6534040	Transistor, 2SA1015-Y
QR38	A6317440	Transistor, 2SC1815-Y
QR39	A6534040	Transistor, 2SA1015-Y
QR40	A6317440	Transistor, 2SC1815-Y
QR41	A6534040	Transistor, 2SA1015-Y
QS01	A6359870	Transistor, 2SC3326-B
QS02	A6359870	Transistor, 2SC3326-B
QS03	A6335470	Transistor, 2SC2712-Y
QS04	A6335470	Transistor, 2SC2712-Y
QS05	A6359870	Transistor, 2SC3326-B
QS06	A6359870	Transistor, 2SC3326-B
QS07	A6014040	Transistor, RN2404
QS08	A6359870	Transistor, 2SC3326-B
QS09	A6359870	Transistor, 2SC3326-B
QS11	A6359870	Transistor, 2SC3326-B
QS12	A6014040	Transistor, RN2404
QV01	B0385650	IC, TA1218N
QV02	A6335470	Transistor, 2SC2712-Y
QV06	A6541130	Transistor, 2SA1162-Y
QV07	A6359870	Transistor, 2SC3326-B
QV08	A6335470	Transistor, 2SC2712-Y
QV09	23114528	Transistor, 2SC1740S, Q
QV10	A6335470	Transistor, 2SC2712-Y
QV11	A6335470	Transistor, 2SC2712-Y
QV12	23114528	Transistor, 2SC1740S, Q
QV14	23114528	Transistor, 2SC1740S, Q
QV15	A6359870	Transistor, 2SC3326-B
QV800	A6317440	Transistor, 2SC1815-Y
QW01	B0410841	IC, TC90A18AF(BH
QW02	23905013	IC, TLC29321PW
QW03	A6030640	IC, TC7S32F
QW04	A6030620	IC, TC7S04F
QW05	A6030640	IC, TC7S32F
QW06	A6030107	IC, TC7S14F
QW06	A6317440	Transistor, 2SC1815-Y
QW07	A6030685	IC, TC7S86F
QW07	A6734590	Transistor, 2SC752(G)TM-Y
QW08	B0485997	IC, TC74HC74AF
QW09	A6317440	Transistor, 2SC1815-Y
QW10	23314204	Transistor, 2SC2412K, Q
QW10	A6534040	Transistor, 2SA1015-Y
QW11	23314204	Transistor, 2SC2412K, Q
QW12	23314204	Transistor, 2SC2412K, Q
QW13	23314204	Transistor, 2SC2412K, Q
QW14	23314204	Transistor, 2SC2412K, Q
QW15	23314204	Transistor, 2SC2412K, Q
QW18	23314204	Transistor, 2SC2412K, Q
QW19	A6317440	Transistor, 2SC1815-Y
QW20	23314204	Transistor, 2SC2412K, Q
QW20	A6317440	Transistor, 2SC1815-Y
QW21	23314202	Transistor, 2SA1037K, Q
QW22	23314204	Transistor, 2SC2412K, Q
QW23	23314202	Transistor, 2SA1037K, Q
QW24	23314204	Transistor, 2SC2412K, Q

Location No.	Part No.	Description
QW25	23314202	Transistor, 2SA1037K, Q
QW30	A6335470	Transistor, 2SC2712-Y
QW31	23906295	IC, $\mu$ PC29M33HB
QW32	A6361770	Transistor, 2SC3437-Y
QW40	23314202	Transistor, 2SA1037K, Q
QW41	23314202	Transistor, 2SA1037K, Q
QW42	23314202	Transistor, 2SA1037K, Q
QW43	23314202	Transistor, 2SA1037K, Q
QW51	23314701	Transistor, 2SB1186A, E
QW52	23314705	Transistor, 2SD1763A, VE
QZ01	B0410895	IC, TC90A30AF(BH)
QZ02	A6335470	Transistor, 2SC2712-Y
QZ03	A6541130	Transistor, 2SA1162-Y
QZ04	A6541130	Transistor, 2SA1162-Y
QZ05	A6541130	Transistor, 2SA1162-Y
QZ06	A6541130	Transistor, 2SA1162-Y
QZ07	A6541130	Transistor, 2SA1162-Y
QZ08	A6335470	Transistor, 2SC2712-Y
D101	23316756	Diode, Zener, MTZJ33D
D201	23118041	Diode, MA111-(TX)
D301	23118479	Diode, BYD33J
D302	23118479	Diode, BYD33J
D303	23115599	Diode, 1N4148
D308	23118822	Diode, ERB12-02
D309	23118822	Diode, ERB12-02
D312	23115599	Diode, 1N4148
D316	23115599	Diode, 1N4148
D317	23115599	Diode, 1N4148
D331	23115599	Diode, 1N4148
D332	23316794	Diode, SC570ALFE2
D342	23115599	Diode, 1N4148
D351	23115599	Diode, 1N4148
D352	23115599	Diode, 1N4148
D353	23316672	Diode, Zener, MTZJ5.6B
D354	23115599	Diode, 1N4148
D360	23316677	Diode, Zener, MTZJ6.8A
D370	23316672	Diode, Zener, MTZJ5.6B
D371	23115599	Diode, 1N4148
D372	23118479	Diode, BYD33J
D401	23316687	Diode, Zener, MTZJ9.1B
D406	A7978850	Diode, S5295G
D408	23118338	Diode, RU-4AM LF-L1
D421	23118041	Diode, MA111-(TX)
D427	23316680	Diode, Zener, MTZJ7.5A
D428	23316751	Diode, Zener, MTZJ30C
D429	23316725	Diode, Zener, MTZJ15B
D430	23316568	Diode, Zener, MA8051-M, TX
D431	23316558	Diode, HSM2836C, TL
D432	23316568	Diode, Zener, MA8051-M, TX
D441	23316688	Diode, Zener, MTZJ9.1C
D443	23118338	Diode, RU-4AM LF-L1
D444	23118338	Diode, RU-4AM LF-L1
D448	23118479	Diode, BYD33J
D460	A7568480	Diode, TVR1G
D461	23316582	Diode, ERC20-06
D461C	23960136	Adhesive, TSE3843-W
D462	23115599	Diode, 1N4148
D463	23115599	Diode, 1N4148
D464	23316718	Diode, Zener, MTZJ12A
D465	23316718	Diode, Zener, MTZJ12A
D467	23118479	Diode, BYD33J
D470	23115599	Diode, 1N4148
D471	A7568460	Diode, TVR-1B
D474	23316719	Diode, Zener, MTZJ12B

Location No.	Part No.	Description
D481	23316726	Diode, Zener, MTZJ15C
D482	23118479	Diode, BYD33J
D483	23316720	Diode, Zener, MTZJ12C
D484	23316668	Diode, Zener, MTZJ5.1A
D486	23115599	Diode, 1N4148
D487	23118479	Diode, BYD33J
D488	23115599	Diode, 1N4148
D489	23316681	Diode, Zener, MTZJ7.5B
D503	23115599	Diode, 1N4148
D504	23115599	Diode, 1N4148
D506	23115599	Diode, 1N4148
D601	23115599	Diode, 1N4148
D602	23115599	Diode, 1N4148
D603	23115599	Diode, 1N4148
D604	23115599	Diode, 1N4148
D611	23115599	Diode, 1N4148
D612	23115599	Diode, 1N4148
D613	23115599	Diode, 1N4148
D614	23115599	Diode, 1N4148
D615	23115599	Diode, 1N4148
D635	23115599	Diode, 1N4148
D671	23316739	Diode, Zener, MTZJ22C
D701	23118859	Diode, 1SS133
D702	23118859	Diode, 1SS133
D703	23118859	Diode, 1SS133
D704	23118859	Diode, 1SS133
D801	23316962	Diode, S1WBA20 4101
D802	23357041	Diode, LN6SB60-F05
D802B	72471082	Screw, BRDT2W3X10 SZN
D803	23316718	Diode, Zener, MTZJ12A
D804	23316718	Diode, Zener, MTZJ12A
D805	23316686	Diode, Zener, MTZJ9.1A
D806	23316747	Diode, Zener, MTZJ27C
D809	23316753	Diode, Zener, MTZJ33A
D810	23316747	Diode, Zener, MTZJ27C
D811	23118057	Diode, AG01A
D812	23316688	Diode, Zener, MTZJ9.1C
D813	23118060	Diode, AL01Z
D814	23316672	Diode, Zener, MTZJ5.6B
D816	24000656	Varistor, TNR15G471K
D817	23115599	Diode, 1N4148
D818	23115599	Diode, 1N4148
D819	23115599	Diode, 1N4148
D820	23316671	Diode, Zener, MTZJ5.6A
D821	23316718	Diode, Zener, MTZJ12A
D822	23316662	Diode, Zener, MTZJ4.3A
D853	23316813	Diode, EG1
D854	23316813	Diode, EG1
D855	23357215	Diode, D4SBS6
D855B	70391355	Screw, BITTB3X8 SZN
D856	23357216	Diode, D4SBL20U
D856B	70391355	Screw, BITTB3X8 SZN
D857	23115532	Diode, ERB12-01
D858	23115599	Diode, 1N4148
D859	23357214	Diode, D4SBS4
D859B	70391355	Screw, BITTB3X8 SZN
D860	23357217	Diode, D4SBL40
D860B	70391355	Screw, BITTB3X8 SZN
D862	23115599	Diode, 1N4148
D863	23316553	Diode, 1SS145
D891	23115599	Diode, 1N4148
D892	23316745	Diode, Zener, MTZJ27A
D893	23316672	Diode, Zener, MTZJ5.6B
D901	23115599	Diode, 1N4148

Location No.	Part No.	Description
D902	23115599	Diode, 1N4148
D903	23115599	Diode, 1N4148
D911	23115599	Diode, 1N4148
D912	23115599	Diode, 1N4148
D913	23115599	Diode, 1N4148
D914	23115599	Diode, 1N4148
D915	23115599	Diode, 1N4148
D921	23115599	Diode, 1N4148
D922	23115599	Diode, 1N4148
D924	23115599	Diode, 1N4148
D925	23115599	Diode, 1N4148
D926	23115599	Diode, 1N4148
D965	23115599	Diode, 1N4148
D966	23115599	Diode, 1N4148
D7701	23115599	Diode, 1N4148
D7702	23115532	Diode, ERB12-01
D7703	23316751	Diode, Zener, MTZJ30C
D7705	23115599	Diode, 1N4148
D7706	23115599	Diode, 1N4148
D7707	23115599	Diode, 1N4148
D7708	23115599	Diode, 1N4148
D7709	23316675	Diode, Zener, MTZJ6.2B
D7710	23316716	Diode, Zener, MTZJ11B
D7711	23316716	Diode, Zener, MTZJ11B
D7717	23316675	Diode, Zener, MTZJ6.2B
D7718	23316675	Diode, Zener, MTZJ6.2B
D7719	23316675	Diode, Zener, MTZJ6.2B
D7720	23316675	Diode, Zener, MTZJ6.2B
D7721	23316675	Diode, Zener, MTZJ6.2B
D7722	23316675	Diode, Zener, MTZJ6.2B
D7723	23115599	Diode, 1N4148
D7724	23115599	Diode, 1N4148
D7725	23115599	Diode, 1N4148
D8301	23115532	Diode, ERB12-01
D8303	23115532	Diode, ERB12-01
DA01	23115599	Diode, 1N4148
DA43	23115599	Diode, 1N4148
DA44	23115599	Diode, 1N4148
DA45	23115599	Diode, 1N4148
DA46	23115599	Diode, 1N4148
DA420	23115599	Diode, 1N4148
DB01	23358504	Diode (LED), SCL003URC3FX
DB02	23358503	Diode (LED), SCL003MC3FX
DB03	23358515	Diode (LED), SCL003DC3FXG, Orange
DB04	23358503	Diode (LED), SCL003MC3FX
DF01	23316654	Diode, Zener, MTZJ3.0A
DF02	23115599	Diode, 1N4148
DR01	23115599	Diode, 1N4148
DR02	23115599	Diode, 1N4148
DR02	23316557	Diode, HSM221C, TL
DR03	23115599	Diode, 1N4148
DR03	23118351	Diode, Zener, RD4.7M-T1BB2
DR61	23115599	Diode, 1N4148
DR62	23115599	Diode, 1N4148
DR63	23115599	Diode, 1N4148
DR65	23115599	Diode, 1N4148
DV01	23118296	Diode, Zener, RD9.1M-T1BB2
DV02	23118296	Diode, Zener, RD9.1M-T1BB2
DV03	23118296	Diode, Zener, RD9.1M-T1BB2
DV04	23118296	Diode, Zener, RD9.1M-T1BB2
DV05	23118296	Diode, Zener, RD9.1M-T1BB2
DV06	23118296	Diode, Zener, RD9.1M-T1BB2
DV07	23118296	Diode, Zener, RD9.1M-T1BB2

Location No.	Part No.	Description
DV10	23316557	Diode, HSM221C, TL
DV11	23316557	Diode, HSM221C, TL
DV12	23118296	Diode, Zener, RD9.1M-T1BB2
DV14	23118296	Diode, Zener, RD9.1M-T1BB2
DV21	23316557	Diode, HSM221C, TL
DW04	23115599	Diode, 1N4148
DW05	23115599	Diode, 1N4148
DW21	23115599	Diode, 1N4148

**MISCELLANEOUS**

B224	23035412	Screw, BTB 4X12 SZN
B230	23037312	Screw, BTBW 3X12 SZN
B234	23037312	Screw, BTBW 3X12 SZN
B241	23035412	Screw, BTB 4X12 SZN
B330	23037312	Screw, BTBW 3X12 SZN
BB11A	23903022	Socket, 8P
BB11B	23903022	Socket, 8P
BB11C	23368627	Plug, 8P
BB12A	23903022	Socket, 8P
BB12B	23903022	Socket, 8P
BB12C	23368627	Plug, 8P
BB21A	23903022	Socket, 8P
BB21B	23903022	Socket, 8P
BB21C	23368627	Plug, 8P
BB22A	23903022	Socket, 8P
BB22B	23903022	Socket, 8P
BB22C	23368627	Plug, 8P
E921	23964147	Coolant EG/G TCP
E951	23964147	Coolant EG/G TCP
E981	23964147	Coolant EG/G TCP
△F801	23144507	Fuse, 3.15A, 250V
F801A	23165433	Holder, Fuse
F801B	23165433	Holder, Fuse
△F860	23144869	Fuse, 2.5A, 250V
F860A	23165433	Holder, Fuse
F860B	23165433	Holder, Fuse
△F870	23144867	Fuse, 4.0A, 250V
F870A	23165433	Holder, Fuse
F870B	23165433	Holder, Fuse
G005	23115599	Diode, 1N4148
G023	24327180	MF, 18 ohm, ±1%, 1/4W
G510	23289479	Coil, Peaking, TRF44R7AF
G527	24567104	PF, 0.1µF
G528	24567104	PF, 0.1µF
G529	24567104	PF, 0.1µF
G602	23238714	Coil, Peaking, TRF4100AJ
G603	23238714	Coil, Peaking, TRF4100AJ
GC05	23103937	Coil (Ferrite Bead), TEM2004
GC06	23103937	Coil (Ferrite Bead), TEM2004
GC07	23103937	Coil (Ferrite Bead), TEM2004
GJ02	24000824	Chip Jumper, 2125Type
GJ03	24000824	Chip Jumper, 2125Type
GJ04	24000824	Chip Jumper, 2125Type
GJ05	24000824	Chip Jumper, 2125Type
GJ06	24000824	Chip Jumper, 2125Type
GJ08	24000824	Chip Jumper, 2125Type
GJ08	24000824	Chip Jumper, 2125Type
GJ09	24000824	Chip Jumper, 2125Type
GJ09	24000824	Chip Jumper, 2125Type
GJ09	24000824	Chip Jumper, 2125Type
GJ09	24000824	Chip Jumper, 2125Type
GJ26	24000824	Chip Jumper, 2125Type
GJ27	24000824	Chip Jumper, 2125Type
GJ28	24000824	Chip Jumper, 2125Type
GJ61	24000824	Chip Jumper, 2125Type



Location No.	Part No.	Description
GJ62	24000824	Chip Jumper, 2125Type
GJ78	24000824	Chip Jumper, 2125Type
GJ79	24000824	Chip Jumper, 2125Type
GJ80	24000824	Chip Jumper, 2125Type
GJ81	24000824	Chip Jumper, 2125Type
GS01	24000824	Chip Jumper, 2125Type
GV05	23103832	Chip (Ferrite Bead), TEM2125M
GV07	24000824	Chip Jumper, 2125Type
GV08	24000824	Chip Jumper, 2125Type
GV11	24000824	Chip Jumper, 2125Type
GV13	24872681	Chip, 680 ohm, 1/16W
GV14	24000824	Chip Jumper, 2125Type
GV15	24000824	Chip Jumper, 2125Type
GV17	24000824	Chip Jumper, 2125Type
GV38	24000824	Chip Jumper, 2125Type
GV39	24000824	Chip Jumper, 2125Type
GV40	24000824	Chip Jumper, 2125Type
GV41	24872102	Chip, 1k ohm, 1/16W
GV97	24872101	Chip, 100 ohm, 1/16W
H002	23148352	Module, MPSN11A, NICAM/IGR A-PRO
KB01	23904946	Remote Sensor, RPM-676CBR-S
P507	23902655	Socket, B-B, 15P
P661	23365444	Jack, Earphone
P701	23368520	Plug, B-B, 20P
P702	23368520	Plug, B-B, 20P
P708	23902863	Socket, 20P
P709	23902863	Socket, 20P
P713	23164787	Plug, 7P
P714	23164787	Plug, 7P
P715	23164787	Plug, 7P
P720	23164786	Plug, 6P
△ P801	23372012	Power Cord(40PW03B)
△ P801	23372014	Power Cord(40PW03G)
P802	23164965	Plug, 4P
P881	23164965	Plug, 4P
PF01A	23367724	Plug, B-B,15P
PH01	23902604	Socket, 21P
PH02	23902604	Socket, 21P
PH03	23902604	Socket, 21P
PU01	23368634	Plug, 25P
PU01A	23903025	Socket, 25P
PU02	23368634	Plug, 25P
PU02A	23903025	Socket, 25P
PV10A	23902863	Socket, 20P
PV10B	23368520	Plug, B-B, 20P
PV11A	23902863	Socket, 20P
PV11B	23368520	Plug, B-B, 20P
PW01	23368130	Plug, B-B,10P
PW02	23368130	Plug, B-B,10P
PW06	23902213	Socket, B-B, 10P
PW07	23902213	Socket, B-B, 10P
S602	23145412	Switch, Slide, 2C2P
△ S801	23145434	Switch Power, 2C2P
SA01	23145226	Switch, Push, 1C1P
SA02	23145226	Switch, Push, 1C1P
SA03	23145226	Switch, Push, 1C1P
SA04	23145226	Switch, Push, 1C1P
SA06	23145226	Switch, Push, 1C1P
SA07	23145226	Switch, Push, 1C1P
△ SR81	23146572	Relay, DC5V, DG5D1-O(M)-2
△ V901A	23902019	Socket, CRT, 9P

Location No.	Part No.	Description
V901R	23004868	Protector Coupling R
△ V902A	23902019	Socket, CRT, 9P
V902G	23004869	Protector Coupling G
△ V903A	23902019	Socket, CRT, 9P
V903B	23004870	Protector Coupling B
W661	23351131	Speaker, SPK-1390, 120X120mm, 16 ohm
W662	23351131	Speaker, SPK-1390, 120X120mm, 16 ohm
X401	23153721	Ceramic Resonator, 503kHz, TCR1023
X501	23153961	Crystal, 3.58MHz
X503	23153979	Crystal, 4.43MHz
XA01	23153497	Crystal, 16.0 MHz
XF01	23153421	Crystal, 20.48MHz
XQ01	23153969	Crystal, 4.00MHz
XV01	23107519	Ceramic Video Trap, 4.43MHz, TCF1066
△ Z410	23110842	Focus Pack, TPA6031
Z410A	23505177	Focus Cable
△ Z450	24082877	CR Block, TPA5007
Z450A	23504953	Anode Cable
Z470	23110845	Focus Pack, TPA6032BH
Z702	23103823	Filter, TEM2027D
Z703	23103823	Filter, TEM2027D
Z704	23103823	Filter, TEM2027D
Z705	23103823	Filter, TEM2027D
Z706	23103823	Filter, TEM2027D
Z707	23103823	Filter, TEM2027D
Z711	23103823	Filter, TEM2027D
Z712	23103823	Filter, TEM2027D
△ Z801	23905010	IC, HIC1019
△ Z853	23144608	Fuse, 4.0A, DC60V
△ Z854	23144608	Fuse, 4.0A, DC60V
△ Z856	23144605	Fuse, 2.0A, DC60V
<b>PC BOARD ASSEMBLIES</b>		
* U901A	23783174	CRT-D R Board, PB8764A-1 (40PW03G)
* U901A	23784697	CRT-D R Board, PB8764D-1 (40PW03B)
* U901B	23783175	CRT-D G Board, PB8764A-2 (40PW03G)
* U901B	23784698	CRT-D G Board, PB8764D-2 (40PW03B)
* U901C	23783176	CRT-D B Board, PB8764A-3 (40PW03G)
* U901C	23784699	CRT-D B Board, PB8764D-3 (40PW03B)
* U901D	23783177	SVM Board, PB8764A-4 (40PW03G)
* U901D	23784701	SVM Board, PB8764D-4 (40PW03B)
* U902A	23784622	Signal Board, PB9402B (40PW03G)
* U902A	23784700	Signal Board, PB9402A (40PW03B)
* U903	23784625	ED-WAC Board, PB8892B
* U904	23784623	DEF Board, PB9403A
* U905	23784626	VCD Board, PB8768G
* U906A	23784631	TEXT Board, PB9411A
* U907	23784628	D-CONVER Board, PB9405A
* U908	23784624	Power Board, PB9404A
* U909	23783171	Conver Board, PB8773A

Location No.	Part No.	Description
* U910	23784627	BACK-T Board, PB8774C
* U911A	23784629	FRONT Board, PB9406A-1
* U911B	23784630	RMT Board, PB9406A-3
* U911C	23784643	LED Board, PB9406A-2
<b>PICTURE TUBE</b>		
△ V911R	23588477	Projection Tube CRT R
△ V912B	23588479	Projection Tube CRT B
△ V912G	23588478	Projection Tube CRT G
<b>TUNER</b>		
H001	23321344	Tuner, EGA22LWX1
<b>ACCESSORIES</b>		
K902	23306324	Remote Hand Unit, CT-90003
AT03	23588265	Battery Cover
Y101E	23563880	Owner's Manual, English, 40PW03G/40PW03B
Y101F	23563881	Owner's Manual, French, 40PW03G/40PW03B
Y101G	23563882	Owner's Manual, German, 40PW03G/40PW03B
Y101I	23563883	Owner's Manual, Italian, 40PW03G/40PW03B
Y101S	23563884	Owner's Manual, Spanish, 40PW03G/40PW03B
<b>CABINET PARTS</b>		
A102	23527078	Speaker Grille R
A103	23527079	Speaker Grille L
A125	23560038	Label
A201	23549940	Bezel
A212	23450231	Control Panel
A213	23427812	Door
A214	70368125	Push Catch for Door
A223	23445386	Button, Power
A268	23450237	Front Panel
A410	23564155	Label, Model No.(40PW03G)
A410	23564212	Label, Model No.(40PW03B)
△ A420	23549370	Back Cover
A424	23411329	Back Board
A501	23035412	Screw, BTB4X12SZN
A505	72471068	Screw, BIDT2 4X12BZ
A508	23035412	Screw, BTB4X12SZN
A510	23030815	Screw, PTD #6 X 3/4
A513	23035412	Screw, BTB4X12SZN
A514	23030815	Screw, PTD #6 X 3/4
A519	23030815	Screw, PTD #6 X 3/4
A521	23030815	Screw, PTD #6 X 3/4
A529	23037312	Screw, BTBW3X12SZN
A533	23030815	Screw, PTD #6 X 3/4
A535	23030815	Screw, PTD #6 X 3/4
A541	23030815	Screw, PTD #6 X 3/4
A543	72471068	Screw, BIDT2 4X12BZ
A544	23030815	Screw, PTD #6 X 3/4
A701	23064168	Carton
A703	23935998	Packing, Top
A710	23935999	Packing, Bottom
A721	23541008	Bag
A726	23845450	Joint
K101	23430512	Delta, DELTA67-A/B
K102	23430512	Delta, DELTA67-A/B

Location No.	Part No.	Description
K103	23430512	Delta, DELTA67-A/B
K501	23430744	Fresnel Sheet, SCREEN40KKEL
K502	23430632	Fresnel Sheet, SCREEN40KJ-F
K503	23430745	Screen Protector, SCR-PRO40AKE
K601	23430648	Millor, MIRROR40J

SIGNAL BOARD PB9402A  
BOTTOM (FOIL) SIDE

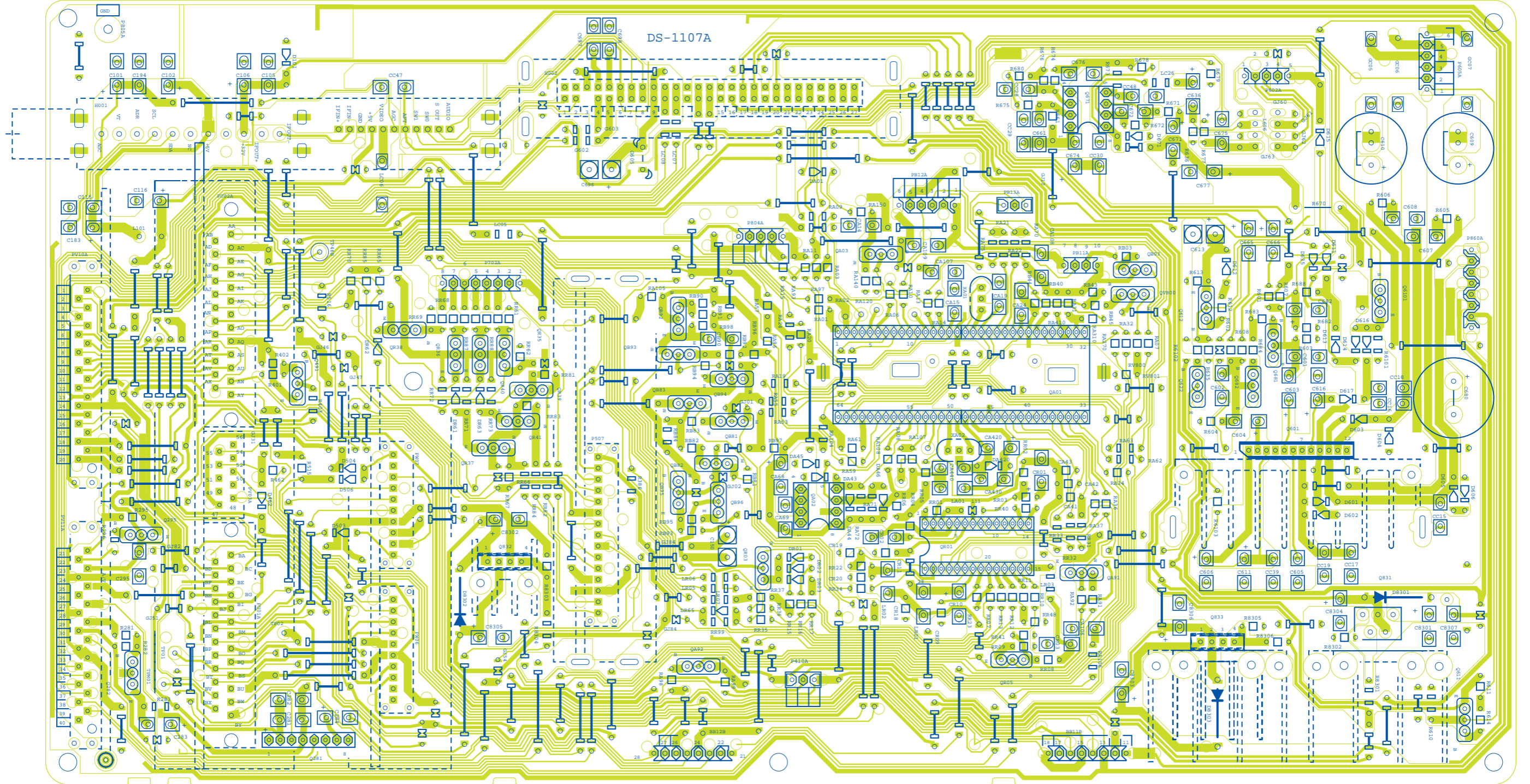





**POWER BOARD PB9404A**  
**BOTTOM (FOIL) SIDE**

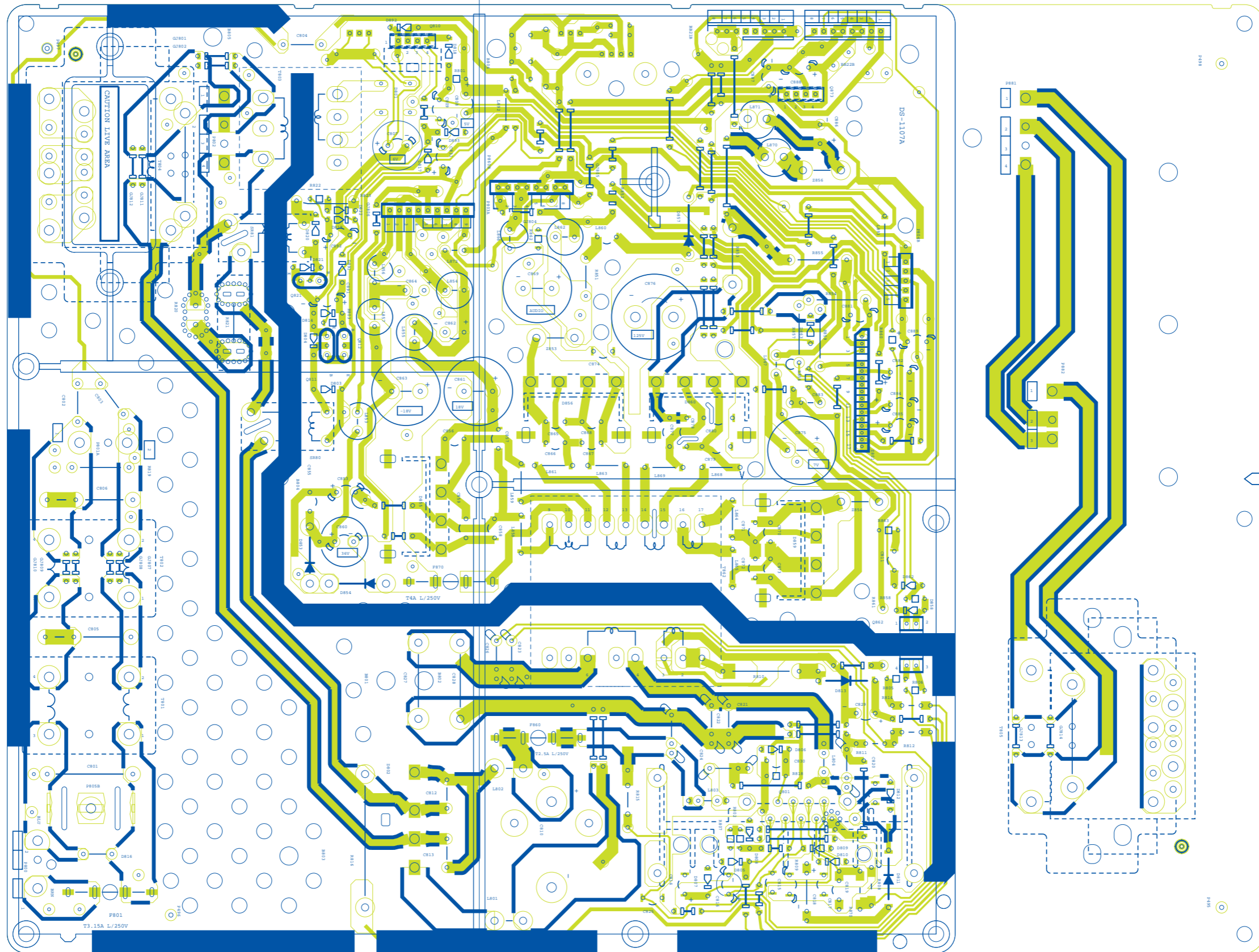



BACK/T BOARD PB8774C  
BOTTOM (FOIL) SIDE

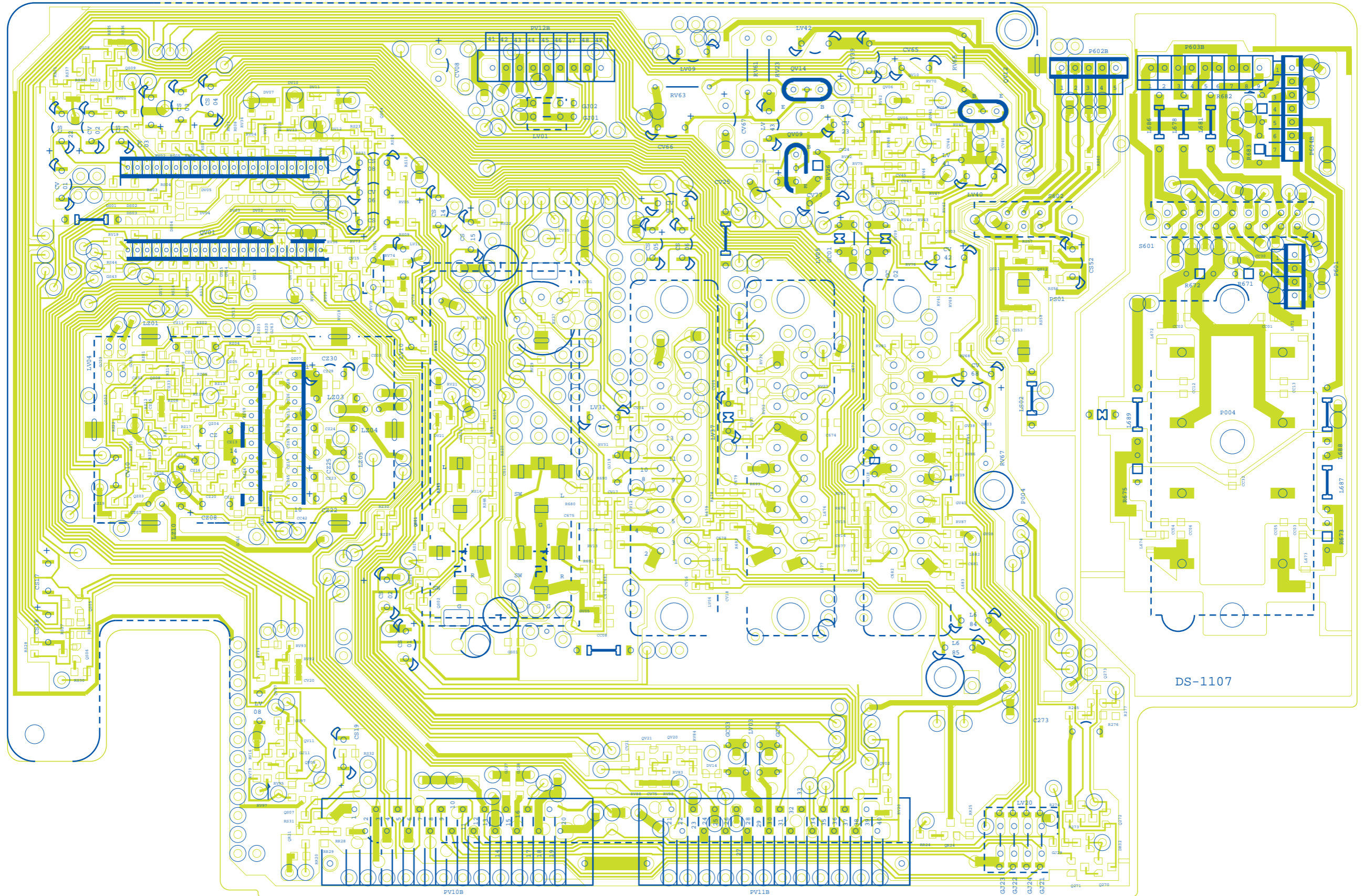

DS-1107

# CONVER BOARD PB8773A

## BOTTOM (FOIL) SIDE

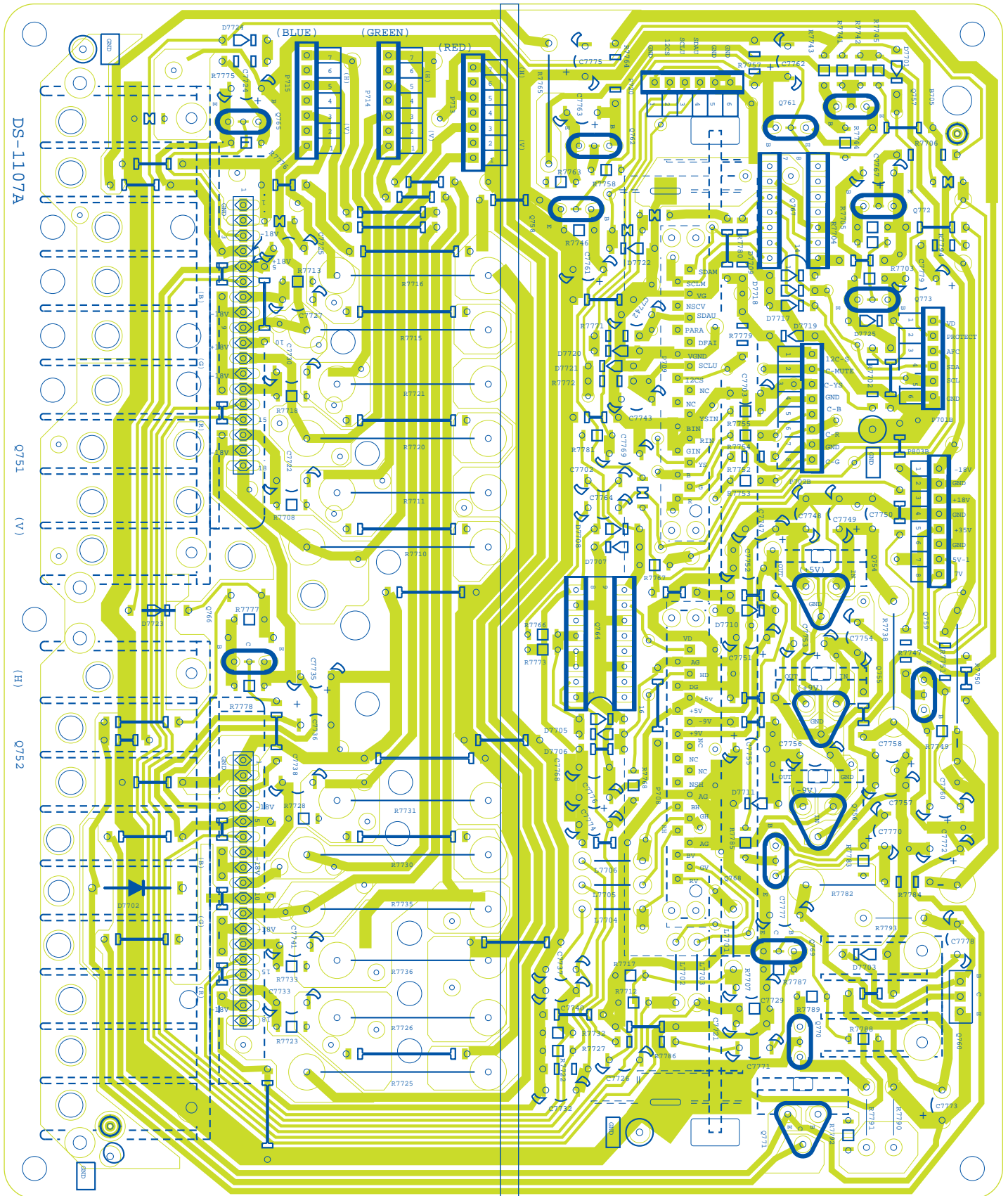





**R-DRIVE BOARD PB8764A-1**  
**BOTTOM (FOIL) SIDE**

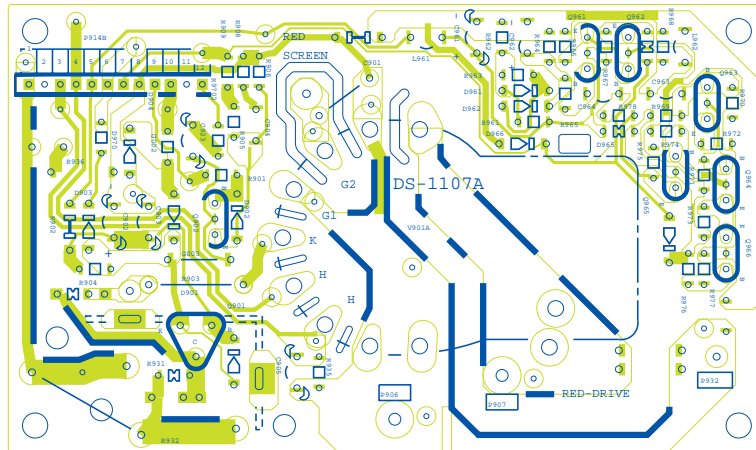

**G-DRIVE BOARD PB8764A-2**  
**BOTTOM (FOIL) SIDE**

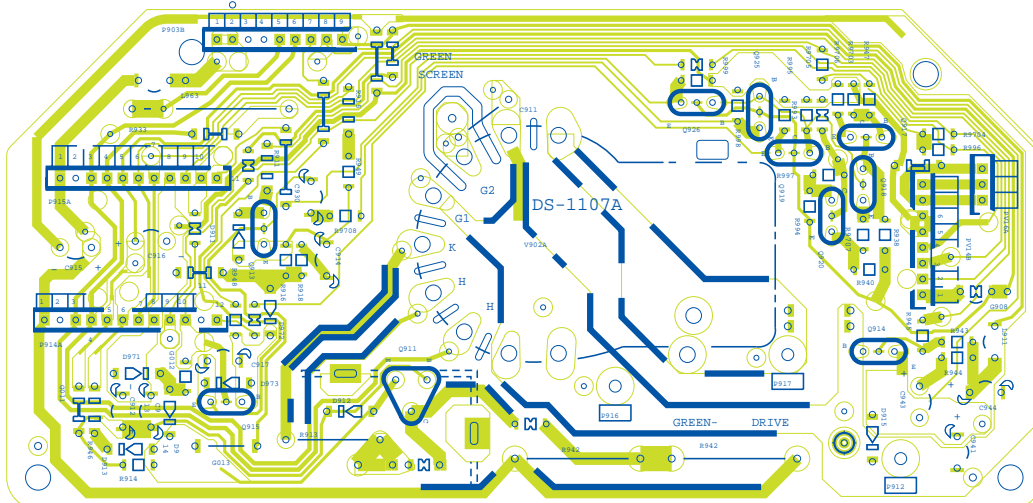

**B-DRIVE BOARD PB8764A-3**  
**BOTTOM (FOIL) SIDE**

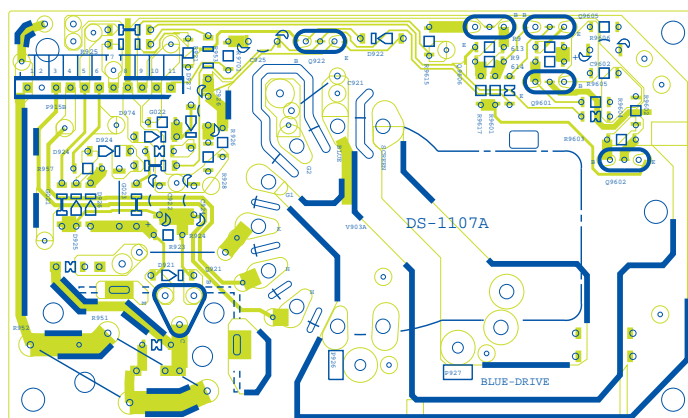

**SVM BOARD PB8764A-4**  
**BOTTOM (FOIL) SIDE**

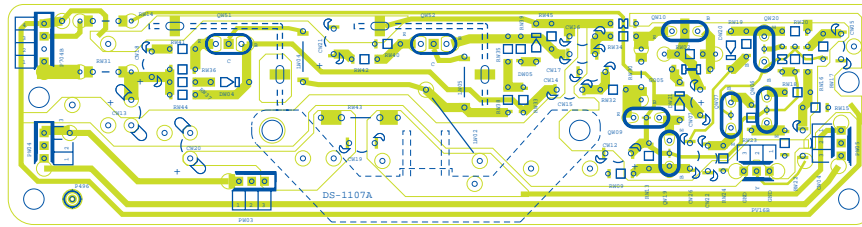

**FRONT BOARD PB9406A-1**  
**BOTTOM (FOIL) SIDE**

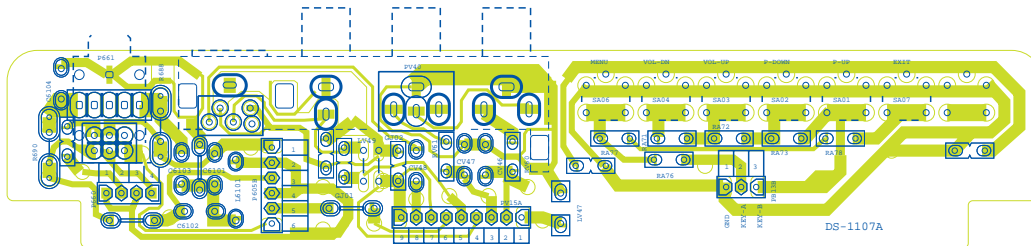

**LED BOARD PB9406A-2**  
**BOTTOM (FOIL) SIDE**

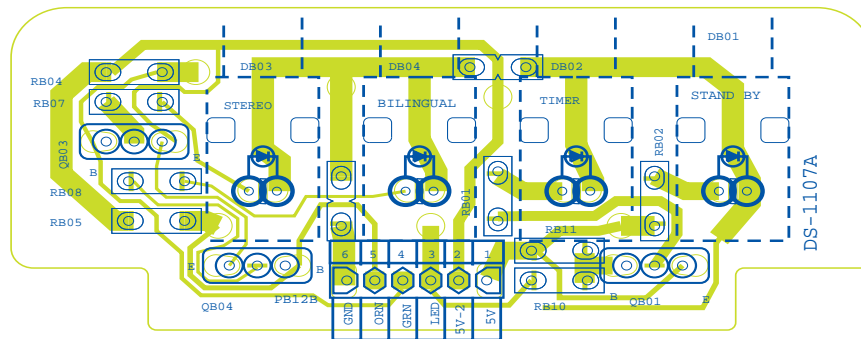

**RMT BOARD PB9406A-3**  
**BOTTOM (FOIL) SIDE**

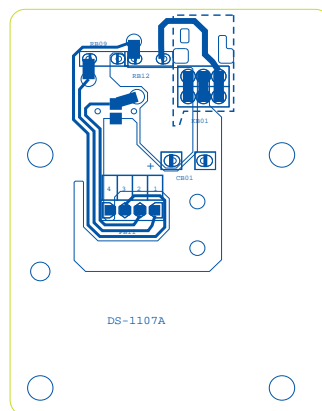

VCD BOARD PB8768G  
BOTTOM (FOIL) SIDE

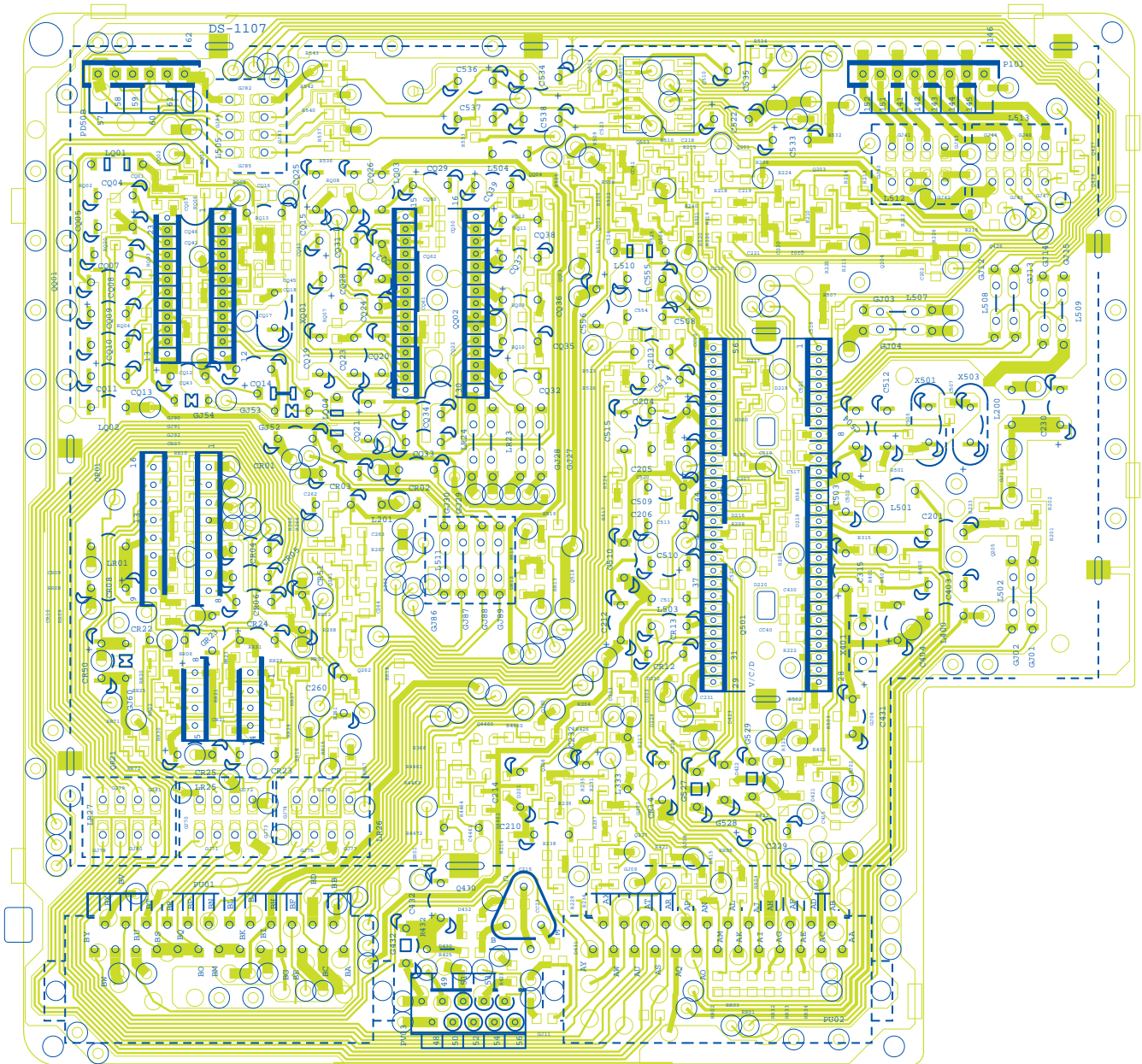



# TERMINAL VIEW OF TRANSISTORS

- ① 2SD2253  
(old)  
2SC5243

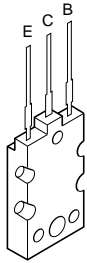

- ② 2SC3852  
2SD1763A  
2SC1569  
2SC4544  
2SA1788  
2SA1306  
2SA1186A

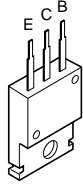

- ③ 2SC752GTM  
2SC2482  
2SC2655  
2SC4721P

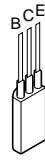

- ④ 2SC752  
2SA562TM  
2SA1015  
2SC1815  
2SC2878  
2SC1740S  
2SC2120  
2SA9335



- ⑤ 2SA1788

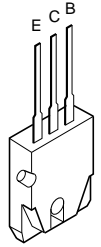

- ⑥ RN2203  
RN2201  
RN2004  
RN1203  
RN1204  
RN2204  
RN1205  
RN1202  
RN1201

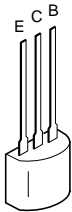

- ⑦ 2SD1554  
2SD2253  
2SD1556  
2SC5143  
2SD2553

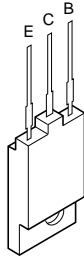

- ⑧ ON4409

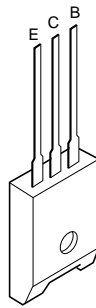

**SPECIFICATIONS (Representative : 40PW03G)**

Rated voltage		AC 230 V, 50/60 Hz				
Power consumption (at AC 220 V, 50 Hz)		150 W				
Dimensions (Width × Height × Depth)		963.2 mm × 1119.7 mm × 466 mm				
Mass		51.0 kg				
Screen size		Type 40				
Television system (Aerial input)	Channel coverage	<b>System</b>	<b>Channel</b>	<b>VHF</b>	<b>UHF</b>	<b>CATV</b>
	Special RF signal	<b>Colour system</b>	<b>Sound system</b>			
		PAL B/G	CCIR	2 – 12	21 – 69	X ~ Z+2, S1 ~ S41
		PAL I	UK	—	21 – 69	—
		SECAM L	CCIR	*	21 – 69	* VHF : B-C ; 1-6, B-Q, 71-86
		SECAM D/K	OIRT	1 – 12	21 – 69	X1 ~ X19
		4.43NTSC	5.5/6.0/6.5 MHz			
		PAL 60Hz	5.5/6.0/6.5 MHz			
Colour system		PAL/SECAM/4.43NTSC/3.58NTSC				
Sound output		14 W + 14 W				
Accessories		<ul style="list-style-type: none"> <li>• Remote control unit           × 1</li> <li>• Battery (R03, AAA)           × 2</li> </ul>				

\* Please refer to owner's manual in detail.

**TOSHIBA CORPORATION**  
1-1, SHIBAURA 1-CHOME, MINATO-KU, TOKYO 105-8001, JAPAN