



# 4126

## NPN EPITAXIAL SILICON TRANSISTOR

### HIGH FREQUENCY SWITCHING TRANSISTORS FOR BALLASTERS

■ DESCRIPTION

UTC 4126 is designed for specially used for electronic ballasters in 110VAC environment.

■ FEATURES

- \* Triple diffused technology.
- \* High switching speed

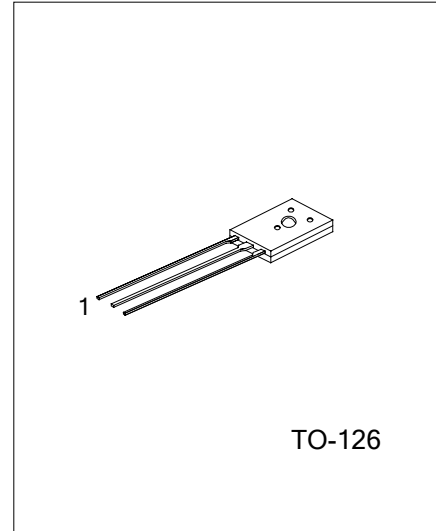

\*Pb-free plating product number: 4126L

■ PIN CONFIGURATION

PIN NO.	PIN NAME
1	Base
2	Collector
3	Emitter

[www.DataSheet4U.com](http://www.DataSheet4U.com)

■ ORDERING INFORMATION

Order Number		Package	Packing
Normal	Lead free		
4126-T60-T	4126L-T60-T	TO-126	Tube

■ ABSOLUTE MAXIMUM RATINGS ( $T_c = 25^\circ\text{C}$ )

PARAMETER	SYMBOL	RATINGS	UNIT
Collector-Base Voltage	$V_{CBO}$	400	V
Collector-Emitter Voltage	$V_{CEO}$	200	V
Collector-Emitter Voltage	$V_{EBO}$	7	V
Peak Collector Current	$I_C$	3	A
Peak Collector Consume Dissipation	$P_D$	40	W
Peak Junction Temperature	$T_J$	150	$^\circ\text{C}$
Storage Temperature	$T_{STG}$	-40 ~ +150	$^\circ\text{C}$

■ ELECTRICAL CHARACTERISTICS ( $T_a = 25^\circ\text{C}$ , unless otherwise specified)

PARAMETER	SYMBOL	TEST CONDITIONS	MIN	TYP	MAX	UNIT
Collector-Emitter Maintenance Voltage	$V_{CEO(SUS)}$	$I_C = 10\text{mA}, I_B = 0$	200			V
Collector-Base Breakdown Voltage	$V_{(BR)CBO}$	$I_C = 1\text{mA}, I_B = 0$	400			V
Emitter-Base Breakdown Voltage	$V_{(BR)EBO}$	$I_E = 1\text{mA}, I_C = 0$	7			V
Collector-Base Cutoff Current	$I_{CBO}$	$V_{CB} = 400\text{V}, I_E = 0$			100	$\mu\text{A}$
Collector-Emitter Cutoff Current	$I_{CEO}$	$V_{CE} = 200\text{V}, I_B = 0$			100	$\mu\text{A}$
Emitter-Base Cutoff Current	$I_{EBO}$	$V_{EB} = 7\text{V}, I_C = 0$			100	$\mu\text{A}$
DC Current Gain	$h_{FE(1)}$	$V_{CE} = 10\text{V}, I_C = 0.5\text{A}$	10		60	
	$h_{FE(2)}$	$V_{CE} = 5\text{V}, I_C = 3\text{A}$	5		40	
Collector-Emitter Saturation Voltage	$V_{CE(sat)}$	$I_C = 0.5\text{A}, I_B = 0.1\text{A}$			0.5	V
		$I_C = 2\text{A}, I_B = 0.5\text{A}$			1.5	V
Base-Emitter Saturation Voltage	$V_{BE(sat)}$	$I_C = 1\text{A}, I_B = 0.25\text{A}$			1.2	V
Fall Time	$t_f$	$I_C = 1\text{A}, I_{B1} = -I_{B2} = 0.2\text{A}$			0.7	$\mu\text{s}$
Storage Time	$t_s$	$I_C = 1\text{A}, I_{B1} = -I_{B2} = 0.2\text{A}$			4	$\mu\text{s}$
Feature Frequency	$f_T$	$V_{CE} = 10\text{V}, I_C = 0.1\text{A}$	4			MHz

■ TYPICAL CHARACTERISTICS

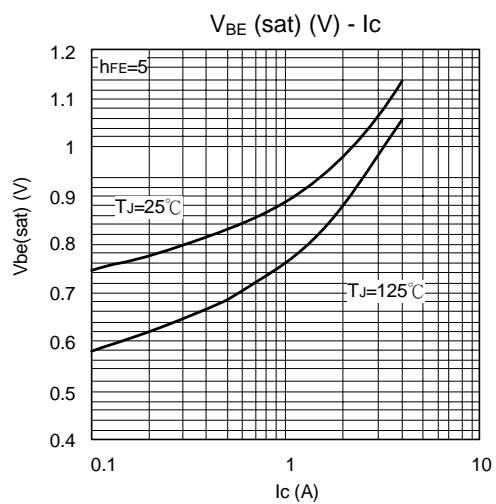
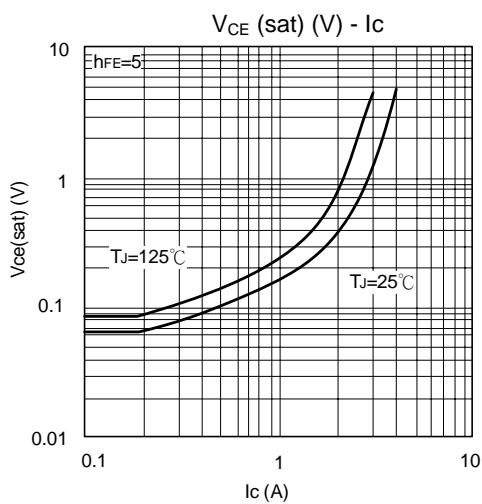
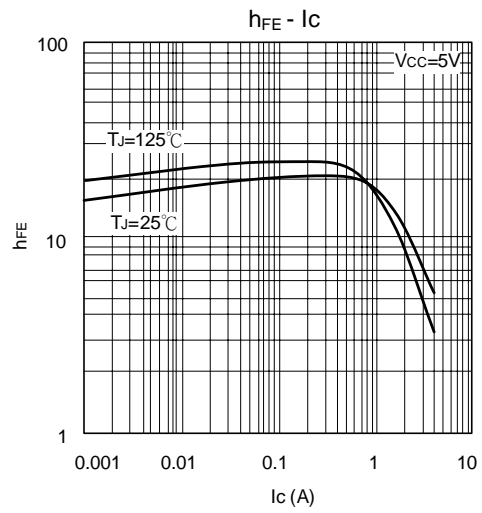
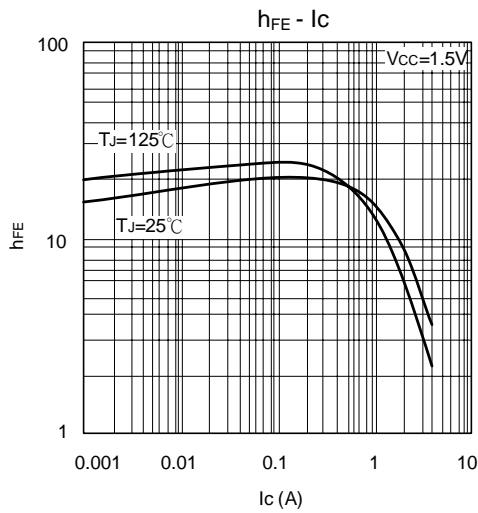
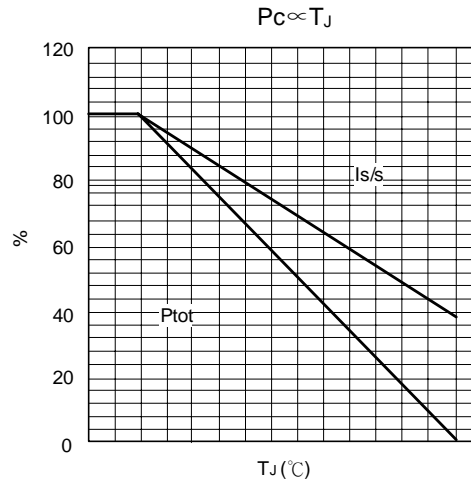
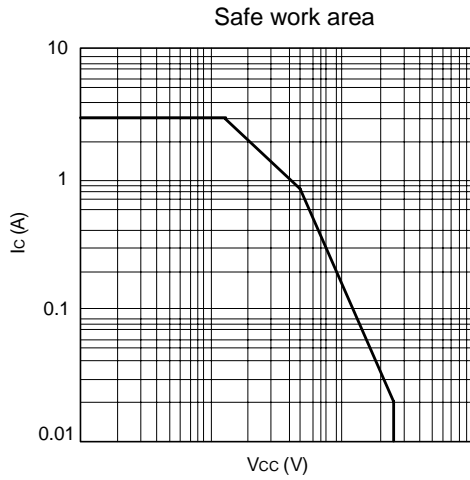

UTC assumes no responsibility for equipment failures that result from using products at values that exceed, even momentarily, rated values (such as maximum ratings, operating condition ranges, or other parameters) listed in products specifications of any and all UTC products described or contained herein. UTC products are not designed for use in life support appliances, devices or systems where malfunction of these products can be reasonably expected to result in personal injury. Reproduction in whole or in part is prohibited without the prior written consent of the copyright owner. The information presented in this document does not form part of any quotation or contract, is believed to be accurate and reliable and may be changed without notice.