



Internal Use Only

website:<http://biz.LGservice.com>

# LCD TV

# SERVICE MANUAL

CHASSIS : LD89F

**MODEL : 42LG6000    42LG6000-ZA**  
**42LG6100    42LG6100-ZB**

## CAUTION

BEFORE SERVICING THE CHASSIS,  
READ THE SAFETY PRECAUTIONS IN THIS MANUAL.

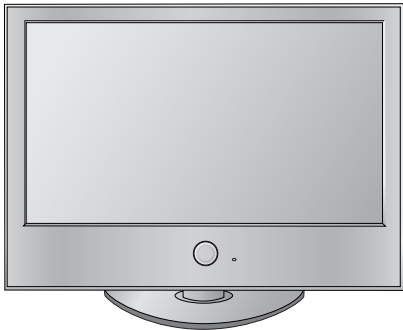

# CONTENTS

<b>CONTENTS .....</b>	<b>2</b>
<b>PRODUCT SAFETY .....</b>	<b>3</b>
<b>SPECIFICATION .....</b>	<b>6</b>
<b>ADJUSTMENT INSTRUCTION .....</b>	<b>13</b>
<b>TROUBLE SHOOTING .....</b>	<b>15</b>
<b>BLOCK DIAGRAM.....</b>	<b>22</b>
<b>EXPLODED VIEW .....</b>	<b>23</b>
<b>SVC. SHEET .....</b>	

# SAFETY PRECAUTIONS

## IMPORTANT SAFETY NOTICE

Many electrical and mechanical parts in this chassis have special safety-related characteristics. These parts are identified by  $\triangle$  in the Schematic Diagram and Replacement Parts List.

It is essential that these special safety parts should be replaced with the same components as recommended in this manual to prevent Shock, Fire, or other Hazards.

Do not modify the original design without permission of manufacturer.

### General Guidance

An **isolation Transformer should always be used** during the servicing of a receiver whose chassis is not isolated from the AC power line. Use a transformer of adequate power rating as this protects the technician from accidents resulting in personal injury from electrical shocks.

It will also protect the receiver and its components from being damaged by accidental shorts of the circuitry that may be inadvertently introduced during the service operation.

If any fuse (or Fusible Resistor) in this TV receiver is blown, replace it with the specified.

When replacing a high wattage resistor (Oxide Metal Film Resistor, over 1W), keep the resistor 10mm away from PCB.

Keep wires away from high voltage or high temperature parts.

### Before returning the receiver to the customer,

always perform an **AC leakage current check** on the exposed metallic parts of the cabinet, such as antennas, terminals, etc., to be sure the set is safe to operate without damage of electrical shock.

### Leakage Current Cold Check(Antenna Cold Check)

With the instrument AC plug removed from AC source, connect an electrical jumper across the two AC plug prongs. Place the AC switch in the on position, connect one lead of ohm-meter to the AC plug prongs tied together and touch other ohm-meter lead in turn to each exposed metallic parts such as antenna terminals, phone jacks, etc.

If the exposed metallic part has a return path to the chassis, the measured resistance should be between  $1M\Omega$  and  $5.2M\Omega$ .

When the exposed metal has no return path to the chassis the reading must be infinite.

An other abnormality exists that must be corrected before the receiver is returned to the customer.

### Leakage Current Hot Check (See below Figure)

Plug the AC cord directly into the AC outlet.

### Do not use a line Isolation Transformer during this check.

Connect 1.5K/10watt resistor in parallel with a 0.15uF capacitor between a known good earth ground (Water Pipe, Conduit, etc.) and the exposed metallic parts.

Measure the AC voltage across the resistor using AC voltmeter with 1000 ohms/volt or more sensitivity.

Reverse plug the AC cord into the AC outlet and repeat AC voltage measurements for each exposed metallic part. Any voltage measured must not exceed 0.75 volt RMS which corresponds to 0.5mA.

In case any measurement is out of the limits specified, there is possibility of shock hazard and the set must be checked and repaired before it is returned to the customer.

### Leakage Current Hot Check circuit

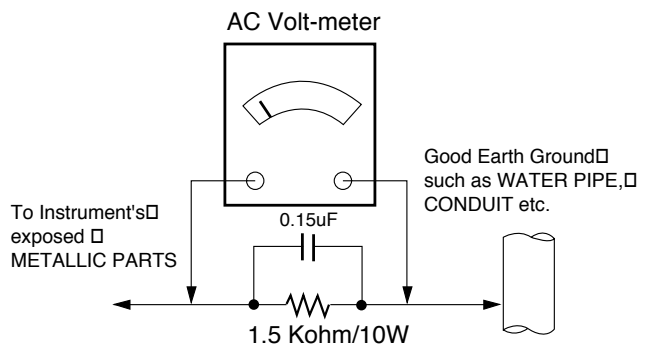

# SERVICING PRECAUTIONS

**CAUTION:** Before servicing receivers covered by this service manual and its supplements and addenda, read and follow the *SAFETY PRECAUTIONS* on page 3 of this publication.

**NOTE:** If unforeseen circumstances create conflict between the following servicing precautions and any of the safety precautions on page 3 of this publication, always follow the safety precautions. Remember: Safety First.

## General Servicing Precautions

1. Always unplug the receiver AC power cord from the AC power source before;
  - a. Removing or reinstalling any component, circuit board module or any other receiver assembly.
  - b. Disconnecting or reconnecting any receiver electrical plug or other electrical connection.
  - c. Connecting a test substitute in parallel with an electrolytic capacitor in the receiver.  
**CAUTION:** A wrong part substitution or incorrect polarity installation of electrolytic capacitors may result in an explosion hazard.

2. Test high voltage only by measuring it with an appropriate high voltage meter or other voltage measuring device (DVM, FETVOM, etc) equipped with a suitable high voltage probe. Do not test high voltage by "drawing an arc".

3. Do not spray chemicals on or near this receiver or any of its assemblies.

4. Unless specified otherwise in this service manual, clean electrical contacts only by applying the following mixture to the contacts with a pipe cleaner, cotton-tipped stick or comparable non-abrasive applicator; 10% (by volume) Acetone and 90% (by volume) isopropyl alcohol (90%-99% strength)

**CAUTION:** This is a flammable mixture.

Unless specified otherwise in this service manual, lubrication of contacts is not required.

5. Do not defeat any plug/socket B+ voltage interlocks with which receivers covered by this service manual might be equipped.
6. Do not apply AC power to this instrument and/or any of its electrical assemblies unless all solid-state device heat sinks are correctly installed.
7. Always connect the test receiver ground lead to the receiver chassis ground before connecting the test receiver positive lead.

Always remove the test receiver ground lead last.

8. Use with this receiver only the test fixtures specified in this service manual.

**CAUTION:** Do not connect the test fixture ground strap to any heat sink in this receiver.

## Electrostatically Sensitive (ES) Devices

Some semiconductor (solid-state) devices can be damaged easily by static electricity. Such components commonly are called *Electrostatically Sensitive (ES) Devices*. Examples of typical ES devices are integrated circuits and some field-effect transistors and semiconductor "chip" components. The following techniques should be used to help reduce the incidence of component damage caused by static by static electricity.

1. Immediately before handling any semiconductor component or semiconductor-equipped assembly, drain off any electrostatic charge on your body by touching a known earth ground. Alternatively, obtain and wear a commercially available discharging wrist strap device, which should be removed to prevent potential shock reasons prior to applying power to the

unit under test.

2. After removing an electrical assembly equipped with ES devices, place the assembly on a conductive surface such as aluminum foil, to prevent electrostatic charge buildup or exposure of the assembly.
3. Use only a grounded-tip soldering iron to solder or unsolder ES devices.
4. Use only an anti-static type solder removal device. Some solder removal devices not classified as "anti-static" can generate electrical charges sufficient to damage ES devices.
5. Do not use freon-propelled chemicals. These can generate electrical charges sufficient to damage ES devices.
6. Do not remove a replacement ES device from its protective package until immediately before you are ready to install it. (Most replacement ES devices are packaged with leads electrically shorted together by conductive foam, aluminum foil or comparable conductive material).
7. Immediately before removing the protective material from the leads of a replacement ES device, touch the protective material to the chassis or circuit assembly into which the device will be installed.  
**CAUTION:** Be sure no power is applied to the chassis or circuit, and observe all other safety precautions.
8. Minimize bodily motions when handling unpackaged replacement ES devices. (Otherwise harmless motion such as the brushing together of your clothes fabric or the lifting of your foot from a carpeted floor can generate static electricity sufficient to damage an ES device.)

## General Soldering Guidelines

1. Use a grounded-tip, low-wattage soldering iron and appropriate tip size and shape that will maintain tip temperature within the range or 500 °F to 600 °F.
2. Use an appropriate gauge of RMA resin-core solder composed of 60 parts tin/40 parts lead.
3. Keep the soldering iron tip clean and well tinned.
4. Thoroughly clean the surfaces to be soldered. Use a mall wire-bristle (0.5 inch, or 1.25cm) brush with a metal handle. Do not use freon-propelled spray-on cleaners.
5. Use the following unsoldering technique
  - a. Allow the soldering iron tip to reach normal temperature. (500 °F to 600 °F)
  - b. Heat the component lead until the solder melts.
  - c. Quickly draw the melted solder with an anti-static, suction-type solder removal device or with solder braid.  
**CAUTION:** Work quickly to avoid overheating the circuitboard printed foil.
6. Use the following soldering technique.
  - a. Allow the soldering iron tip to reach a normal temperature (500 °F to 600 °F)
  - b. First, hold the soldering iron tip and solder the strand against the component lead until the solder melts.
  - c. Quickly move the soldering iron tip to the junction of the component lead and the printed circuit foil, and hold it there only until the solder flows onto and around both the component lead and the foil.  
**CAUTION:** Work quickly to avoid overheating the circuit board printed foil.
  - d. Closely inspect the solder area and remove any excess or splashed solder with a small wire-bristle brush.

## IC Remove/Replacement

Some chassis circuit boards have slotted holes (oblong) through which the IC leads are inserted and then bent flat against the circuit foil. When holes are the slotted type, the following technique should be used to remove and replace the IC. When working with boards using the familiar round hole, use the standard technique as outlined in paragraphs 5 and 6 above.

### Removal

1. Desolder and straighten each IC lead in one operation by gently prying up on the lead with the soldering iron tip as the solder melts.
2. Draw away the melted solder with an anti-static suction-type solder removal device (or with solder braid) before removing the IC.

### Replacement

1. Carefully insert the replacement IC in the circuit board.
2. Carefully bend each IC lead against the circuit foil pad and solder it.
3. Clean the soldered areas with a small wire-bristle brush.  
(It is not necessary to reapply acrylic coating to the areas).

## "Small-Signal" Discrete Transistor

### Removal/Replacement

1. Remove the defective transistor by clipping its leads as close as possible to the component body.
2. Bend into a "U" shape the end of each of three leads remaining on the circuit board.
3. Bend into a "U" shape the replacement transistor leads.
4. Connect the replacement transistor leads to the corresponding leads extending from the circuit board and crimp the "U" with long nose pliers to insure metal to metal contact then solder each connection.

## Power Output, Transistor Device

### Removal/Replacement

1. Heat and remove all solder from around the transistor leads.
2. Remove the heat sink mounting screw (if so equipped).
3. Carefully remove the transistor from the heat sink of the circuit board.
4. Insert new transistor in the circuit board.
5. Solder each transistor lead, and clip off excess lead.
6. Replace heat sink.

## Diode Removal/Replacement

1. Remove defective diode by clipping its leads as close as possible to diode body.
2. Bend the two remaining leads perpendicular y to the circuit board.
3. Observing diode polarity, wrap each lead of the new diode around the corresponding lead on the circuit board.
4. Securely crimp each connection and solder it.
5. Inspect (on the circuit board copper side) the solder joints of the two "original" leads. If they are not shiny, reheat them and if necessary, apply additional solder.

## Fuse and Conventional Resistor

### Removal/Replacement

1. Clip each fuse or resistor lead at top of the circuit board hollow stake.
2. Securely crimp the leads of replacement component around notch at stake top.
3. Solder the connections.

**CAUTION:** Maintain original spacing between the replaced component and adjacent components and the circuit board to prevent excessive component temperatures.

## Circuit Board Foil Repair

Excessive heat applied to the copper foil of any printed circuit board will weaken the adhesive that bonds the foil to the circuit board causing the foil to separate from or "lift-off" the board. The following guidelines and procedures should be followed whenever this condition is encountered.

### At IC Connections

To repair a defective copper pattern at IC connections use the following procedure to install a jumper wire on the copper pattern side of the circuit board. (Use this technique only on IC connections).

1. Carefully remove the damaged copper pattern with a sharp knife. (Remove only as much copper as absolutely necessary).
2. Carefully scratch away the solder resist and acrylic coating (if used) from the end of the remaining copper pattern.
3. Bend a small "U" in one end of a small gauge jumper wire and carefully crimp it around the IC pin. Solder the IC connection.
4. Route the jumper wire along the path of the out-away copper pattern and let it overlap the previously scraped end of the good copper pattern. Solder the overlapped area and clip off any excess jumper wire.

### At Other Connections

Use the following technique to repair the defective copper pattern at connections other than IC Pins. This technique involves the installation of a jumper wire on the component side of the circuit board.

1. Remove the defective copper pattern with a sharp knife. Remove at least 1/4 inch of copper, to ensure that a hazardous condition will not exist if the jumper wire opens.
2. Trace along the copper pattern from both sides of the pattern break and locate the nearest component that is directly connected to the affected copper pattern.
3. Connect insulated 20-gauge jumper wire from the lead of the nearest component on one side of the pattern break to the lead of the nearest component on the other side. Carefully crimp and solder the connections.  
**CAUTION:** Be sure the insulated jumper wire is dressed so the it does not touch components or sharp edges.

# SPECIFICATION

NOTE : Specifications and others are subject to change without notice for improvement.

## 1. General Specification(TV)

No.	Item	Specification	Remark
1.	Video input applicable system	PAL-D/K, B/G, I, SECAM	
2.	Receivable Broadcasting System	1) PAL/SECAM B/G 2) PAL/SECAM D/K 3) PAL I/II 4) SECAM L/L' 5) DVB-T	EU(PAL Market)
3.	RF Input Channel	VHF : E2 ~ E12 UHF : E21 ~ E69 CATV : S1 ~ S20 HYPER : S21~ S47	PAL
4.	Input Voltage	AC 100 ~ 240 V/50Hz, 60Hz	
5.	Picture Size	37 inch 42 inch 47 inch	37LG6000/42LG6000/47LG6000
6.	Tuning System	FVS 100 program	PAL, 200 PR.(Option)
7.	Operating Environment	1) Temp : 0 ~ 40 deg 2) Humidity : 10 ~ 90 %	LGE SPEC
8.	Storage Environment	3) Temp : -20 ~ 50 deg 4) Humidity : 10 ~ 90 %	LGE SPEC
9.	Display	LCD Module	LPL

## 2. General Specification(LCD Module)

No	Item	Specification	Unit	Remark		
1.	Panel	37" TFT WUXGA LCD 42" TFT WUXGA LCD 47" TFT WUXGA LCD		37LG6000 42LG6000 47LG6000		
2.	Frequency range	H : 64.1 ~ 67.5Khz, V : 57 ~ 63Hz H : 121.8 ~ 136.4Khz, V : 108.2 ~ 121.2Hz H : 121.8 ~ 136.4Khz, V : 108.2 ~ 121.2Hz		37 inch 42 inch 47 inch		
3.	Power consumption	37 inch 42 inch 47 inch	$\leq 10.76 + 132$ 9.4(Max) + 160.8(Typ) $\leq \text{TBD} + 240(\text{Max})$	W W W LCD + Backlight		
4.	LCD Module-LPL	Type Size	37"   877 x 516.8 x 55.5 42"   983.0 x 576.0 x 47.3 47"   1096.0 x 640.0 x 50	mm	(H)x (V)x(D)	
		Pixel Pitch	37"   0.42675 x 0.42675 42"   0.4845 x 0.4845 47"   0.5415 x 0.5415	mm		
		Pixel Format	1920 horiz. By 1080 vert. Pixels RGB stripe arrangement			37/42/47 inch
		Coating	Hard coating(3H), Anti-glare treatment of the front polarizer(Haze 13%)			
		Back Light	37"   16 Lamp(EEFL) 42"   18 Lamp(EEFL) 47"   22 Lamp(CCFL)			

### 3. Optical Feature(LCD Module)

No.	Item	Specification	Min.	Typ.	Max.	Remark	
1.	Viewing Angle(CR>10)	R/L, U/D		178, 178			
2.	Luminance	Luminance (cd/m2)	400	500		42" without PC (PC: min 300)	
		Variation		-	1.3	MAX / MIN	
3.	Contrast Ratio	CR(37")	1000	1400		All white/All black without PC (PC:min400)	
		CR(42")	1000	1400			
		CR(47")	TBD	1500			
4.	CIE Color Coordinates	White	WX	Typ -0.03	0.279	Typ +0.03	37 inch
			WY		0.292		
		RED	Xr	0.641			
			Yr	0.334			
		Green	Xg	0.291			
			Yg	0.614			
		Blue	Xb	0.145			
			Yb	0.062			
		White	WX	Typ -0.03	0.279	Typ +0.03	42 inch
			WY		0.292		
		RED	Xr	0.640			
			Yr	0.335			
		Green	Xg	0.289			
			Yg	0.610			
		Blue	Xb	0.144			
			Yb	0.066			
		White	WX	Typ -0.03	0.279	Typ +0.03	47 inch
			WY		0.292		
		RED	Xr	0.636			
			Yr	0.334			
		Green	Xg	0.291			
			Yg	0.613			
		Blue	Xb	0.146			
			Yb	0.061			

- 1) Standard Test Condition
- 2) Surrounding Brightness Level : dark
- 3) Surrounding Temperature : 25±2°C
- 4) warm-up Time : 30 Min
- 5) Input Signal : VESA XGA 60Hz
  - Contrast, Brightness : Max.
  - Clock/Clock Phase : accurate adjustment



#### 4. Optical Feature(SET)

No.	Item	Specification	Min.	Typ.	Max.	Remark
1.	Luminance	Luminance (cd/m <sup>2</sup> )	400	450		HDMI
			350	400		RF, AV, RGB
		Variation		-	1.3	MAX / MIN
2	Contrast Ratio	CR(37")	900	1400		All white/All black without PC (PC:min400)
		CR(42")	900	1400		
		CR(47")	900	1300		

#### 5. Component Video Input (Y, P<sub>B</sub>, P<sub>R</sub>)

No.	Specification			Remark
	Resolution	H-freq(kHz)	V-freq(Hz)	
1.	720x480	15.73	60.00	SDTV, DVD 480i
2.	720x480	15.63	59.94	SDTV, DVD 480i
3.	720x480	31.47	59.94	SDTV, 480p
4.	720x480	31.50	60.00	SDTV, 480p
5.	720x576	15.625	50.00	SDTV, DVD 625 Line
6.	720x576	31.25	50.00	HDTV 576p
7.	1280x720	45.00	60.00	HDTV 720p
8.	1280x720	44.96	59.94	HDTV 720p
9.	1280x720	37.50	50	HDTV 720p 50Hz
10.	1920x1080	31.25	50.00	HDTV 1080i
11.	1920x1080	33.75	60.00	HDTV 1080i
12.	1920x1080	33.72	59.94	HDTV 1080i
13.	1920x1080	56.25	50.00	HDTV 1080P
14.	1920x1080	67.433	59.94	HDTV 1080P
15.	1920x1080	67.50	60	HDTV 1080P

#### 6. RGB Input (PC)

No.	Resolution	H-freq(kHz)	V-freq.(Hz)	Pixel clock(MHz)	Proposed
1.	720x400	31.468	70.08	28.32	
2.	640x480	31.469	59.94	25.17	VESA
3.	800x600	37.879	60.31	40.00	VESA
4.	1024x768	48.363	60.00	65.00	VESA(XGA)
5.	1280x768	47.78	59.87	79.5	VESA(WXGA)
6.	1360x768	47.72	59.8	84.625	VESA(WXGA)
7.	1920x1080	66.647	59.988	138.625	WUXGA
8.	1280x1024	63.981	60.02	108	SXGA(Only FHD)
9.	1400x1050	65.317	59.978	121.75	SXGA(Only FHD)

## 7. HDMI DTV

No.	Resolution	H-freq(kHz)	V-freq(Hz)	Pixel clock(MHz)	Proposed	Remark
1.	640x480	31.469	59.94	25.175	SDTV 480p 60Hz	
2.	640x480	31.469	60	25.20	SDTV 480p 60Hz	
3.	720x480	31.47	59.94	27.00	SDTV 480p 60Hz	
4.	720x480	31.50	60	27.027	SDTV 480p 60Hz	
5.	720x576	31.25	50.00	27.000	SDTV 576p 50Hz	
6.	1280x720	37.50	50.00	74.176	HDTV 720p 50Hz	HDCP
7.	1280x720	44.96	59.94	74.176	HDTV 720p 60Hz	HDCP
8.	1280x720	45.00	60	74.250	HDTV 720p 60Hz	HDCP
9.	1920x1080	28.125	50.00	74.250	HDTV 1080i 50Hz	HDCP
10.	1920x1080	33.72	59.94	74.176	HDTV 1080i 60Hz	HDCP
11.	1920x1080	33.75	60	74.250	HDTV 1080i 60Hz	HDCP
12.	1920x1080	27.000	24.00	74.250	HDTV 1080P 24Hz	HDCP
13.	1920x1080	33.750	30	74.25	HDTV 1080P 30Hz	HDCP
14.	1920x1080	56.25	50.00	148.500	HDTV 1080P 50Hz	HDCP
15.	1920x1080	67.433	59.94	148.352	HDTV 1080P 60Hz	HDCP
16.	1920x1080	67.50	60	148.500	HDTV 1080P 60Hz	HDCP

## 8. HDMI input ( DTV )

No.	Resolution	H-freq(kHz)	V-freq(Hz)	Pixel clock(MHz)	Proposed	Remark
1.	720x400	31.468	70.08	28.32		
2.	640x480	31.469	59.94	25.17	VESA	
3.	800x600	37.879	60.31	40.00	VESA	
4.	1024x768	48.363	60.00	65.00	VESA(XGA)	
5.	1280x768	47.78	59.87	80.125	VESA(WXGA)	
6.	1360x768	47.72	59.8	84.625	VESA(WXGA)	
7.	1280x1024	63.981	60.02	108	SXGA(Only FHD)	
8.	1400x1050	65.317	59.978	121.75	SXGA(Only FHD)	
9.	1920x1080	66.647	59.988	138.625	WUXGA	

## 9. Mechanical specification

9-1. 37LG6000

No,	Item	Content				Remark
1	Product Dimenson		Width(W)	Length(D)	Height(H)	Unit
		Before Packing	929	374.7	707	mm
		After Packing	1015	277	782	mm
2	Product Weight	Only SET	21.7			Kg
		With Box	26.2			Kg
3	Container Loading Quantity	Individual or Palletizing	20ft		40ft	
			Indi	Wooden	Indi	Woonden
			291		291	88
4	Stand Assy	Type	Attachde(detachable)			
		Size(W x D x H)	460	375.4	234.1	mm
		Tilt Degree	-			
		Tilt force	-			
		Swivel Degree	Swivel(+/- 20degree)			
		Swivel Force	1.0 ~ 2.0kgf			
5	Appearance	Refer to Standard of LG(56)G4-9002				

9-2. 42LG6000

No,	Item	Content				Remark
1	Product Dimenson		Width(W)	Length(D)	Height(H)	Unit
		Before Packing	1037.6	378	795	mm
		After Packing	1330	257	844	mm
2	Product Weight	Only SET	22.7			Kg
		With Box	27.2			Kg
3	Container Loading Quantity	Individual or Palletizing	40ft		40ft(H-CUBIC)	
			Indi	Wooden	Indi	Woonden
			162		243	
4	Stand Assy	Type	Attachde(detachable)			
		Size(W x D x H)	520.1	379.5	265.1	mm
		Tilt Degree	-			
		Tilt force	-			
		Swivel Degree	Swivel(+/- 20degree)			
		Swivel Force	0.8 ~ 1.5kgf			
5	Appearance	Refer to Standard of LG(56)G4-9002				

9-3. 47LG6000

No,	Item	Content				Remark	
1	Product Dimenson	Width(W)	Length(D)	Height(H)	Unit		
		Before Packing	1152.8	434.5	867.6	mm	
		After Packing	1255	521	961	mm	
2	Product Weight	Only SET	32.6			Kg	
		With Box	37			Kg	
3	Container Loading Quantity	Individual or Palletizing	40ft		40ft(H-CUBIC)		
			Indi	Wooden	Indi	Woonden	
			82		82		
4	Stand Assy	Type	Attachde(detachable)				
		Size(W x D x H)	580	434.5	286.2	mm	
		Tilt Degree	-				
		Tilt force	-				
		Swivel Degree	Swivel(+/- 20degree)				
		Swivel Force	1.5 ~ 1.9kgf				
5	Appearance	Refer to Standard of LG(56)G4-9002					

# ADJUSTMENT INSTRUCTION

## 1. Application Range

This spec. sheet is applied to all of the LD89F chassis manufactured at LG TV Plant all over the world.

## 2. Specification

2.1 Because this is not a hot chassis, it is not necessary to use an isolation transformer. However, the use of isolation transformer will help protect test instrument.

2.2 Adjustment must be done in the correct order.

2.3 The adjustment must be performed in the circumstance of  $25\pm 5^{\circ}\text{C}$  of temperature and  $65\pm 10\%$  of relative humidity if there is no specific designation.

2.4 The input voltage of the receiver must keep 100~240V, 50/60Hz.

2.5 The receiver must be operated for about 15 minutes prior to the adjustment.

- After RGB Full White in HEAT-RUN Mode, the receiver must be operated prior to the adjustment.

- Enter into HEAT-RUN MODE

(1) Press the "POWER ON" KEY on Adjustment R/C.

(2) Press the "ADJ KEY" on Adjustment R/C.

(3) Select "3. Test Pattern" by using ▲/▼(CH +/-) and press ENTER(■)

(4) Select "White" by using ◀/▶(VOL +/-) and press ENTER(■)

• Set is activated HEAT run without signal generator in this mode.

• Single color pattern ( RED / BLUE / GREEN ) of HEAT RUN MODE uses to check panel.

• Caution : If you turn on a still pattern more than 20 minutes (Especially digital pattern, cross hatch pattern), an after image may be occur in the black level part of the screen.

## 3. PCB assembly adjustment method

=> Caution: Using 'power on' button of the Adjustment R/C , power on TV.

• ADC Calibration Protocol (RS232)

NO	Item	CMD 1	CMD 2	Data 0	
Enter Adjust MODE	Adjust 'Mode In'	A	D	0 0	When transfer the 'Mode In' Carry the command.
ADC adjust	ADC Adjust	A	D	1 0	Automatically adjustment (The use of a internal pattern)
	Adjust 'Mode Out'	A	D	9 0	
	Adjustment Confirmation	A	D	9 9	To check ADC Adjustment on Assembly line.

- Baud rate : 115200 bps

- RS232 Host : PC

- echo : none

## 4. ADC adjustment

RF input	AV / Component / RGB input
NO SIGNAL or White noise	NO SIGNAL

- Adjustment can be done using only internal ADC, so input signal is not necessary.
- Required equipment : Adjustment R/C.

1) Press ADJ key on adjustment R/C.

2) Select "1. ADC calibration" by using ▲/▼(CH +/-) and press ENTER(■)

3) Select "Start" by using ◀/▶(VOL +/-) and press ENTER(■)

4) ADC adjustment is executed automatically

## 5. PCMCIA CARD Checking Method

- You must adjust DTV 29 Channel and insert PCMCIA CARD to socket.

1) If PCMCIA CARD works normally, normal signals display on screen. But it works abnormally, "No CA module" words display on screen.

=> Caution: Set up "RF mode" before launching products.

## 6. Adjustment of White Balance

- Test Equipment
- Color Analyzer (CS-1000, CA-100+(CH.9), CA-210(CH.9) )
- \* Please adjust CA-100+ / CA-210 by CS-1000 before measuring

=> You should use Channel 9 which is Matrix compensated (White, Red, Green, Blue revised) by CS-1000 and adjust in accordance with White balance adjustment coordinate

- Color temperature standards according to CSM and Module

CSM	LCD
Cool	11000K
Medium	9300K
Warm	6500K

- Change target luminance and range of the Auto adjustment W/B equipment.

Target luminance	65
Range	20

- White balance adjustment coordinate and color temperature

Cool	CS-1000	CA-100+ (CH.9)	CA-210 (CH.9)
x	0.276	0.276±0.002	0.276±0.002
y	0.283	0.283±0.002	0.283±0.002
△uv	0.000	0.000	0.000
Medium	CS-1000	CA-100+ (CH.9)	CA-210 (CH.9)
x	0.285	0.285±0.002	0.285±0.002
y	0.293	0.293±0.002	0.293±0.002
△uv	0.000	0.000	0.000
Warm	CS-1000	CA-100+ (CH.9)	CA-210 (CH.9)
x	0.313	0.313±0.002	0.313±0.002
y	0.329	0.329±0.002	0.329±0.002
△uv	0.003	0.003	0.003

\* PC (for communication through RS-232C) => UART Baud rate : 115200 bps

### \* Connecting picture of the measuring instrument (On Automatic control)

Inside PATTERN is used when W/B is controlled. Connect to auto controller or push Adjustment R/C IN-START -> Enter the mode of White-Balance, the pattern will come out.

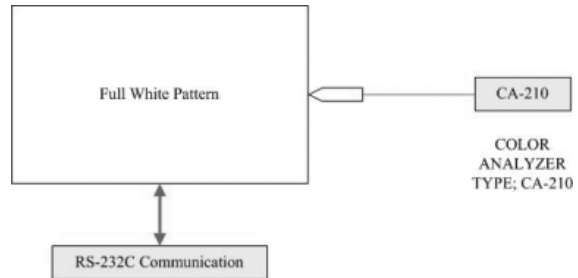

[Fig.5] connecting picture (On Automatic Control)

### Auto-control interface and directions

- Adjust in the place where the influx of light like floodlight around is blocked. (illumination is less than 10ux).
- Adhere closely the Color Analyzer (CA-210) to the module less than 10cm distance, keep it with the surface of the Module and Color Analyzer's Prove vertically.(80~100°).
- Aging time
  - After aging start, keep the power on (no suspension of power supply) and heat-run over 15 minutes.
  - Using 'no signal' or 'full white pattern' or the others, check the back light on.

## 6. Manual white Balance

- Press the ADJ KEY on Adjustment R/C.
  - Select "3. Test Pattern" by using ▲/▼(CH +/-) and press ENTER(■)
  - Select "White" by using ◀/▶(VOL +/-) and press ENTER(■) and heat run over 15 minutes.
- Zero Calibrate CA-100+ / CA-210, and when controlling, stick the sensor to the center of LCD module surface.
- Press the ADJ KEY on Adjustment R/C
- Select "2. White Balance" and press ▶(VOL +) Set test-pattern on and display inside pattern.
- Control is carried out on three color temperatures, COOL, MEDIUM, WARM.

(Control is carried out three times)

< Temperature: COOL >

- R-Cut / G-Cut / B-Cut is set to 64.

- Control R-Gain and G-Gain.

- Each gain is limited to 192.

< Temperature: MEDIUM >

- R-Cut / G-Cut / B-Cut is set to 64.

- Control R-Gain and B-Gain.

- Each gain is limited to 192.

< Temperature: WARM >

- R-Cut / G-Cut / B-Cut is set to 64.

- Control G-Gain and B-Gain.

- Each gain is limited to 192.

\* One of R Gain / G Gain / B Gain should be kept on 192, and adjust other two lower than 192.

(When R/G/B GAIN are all 192, it is the FULL DYNAMIC Range of Module)

# TROUBLE SHOOTING

## 1. Power Board

### 1-1. The whole flowchart which it follows in voltage output state

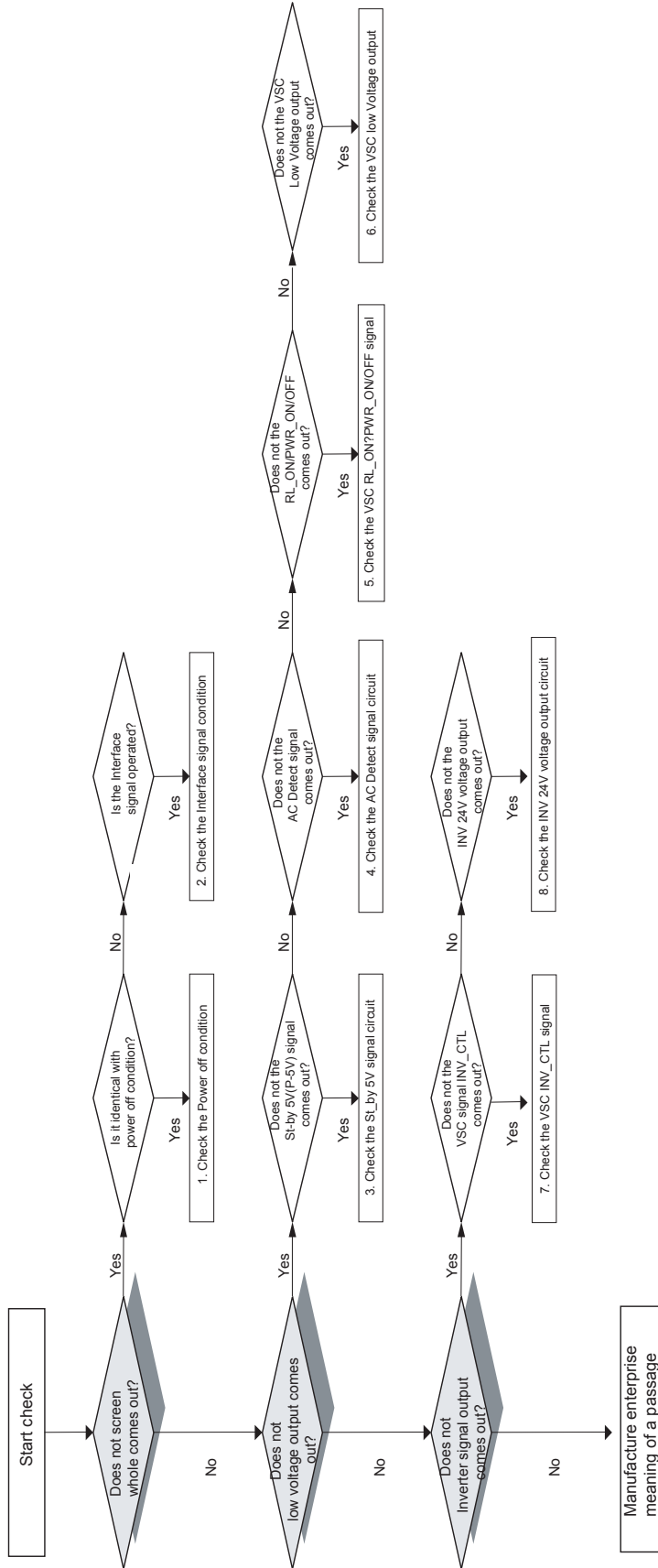

## 2. No Power



### Symptom

- 1) It does not charge at module.
- 2) Front LED does not work

Check the followings

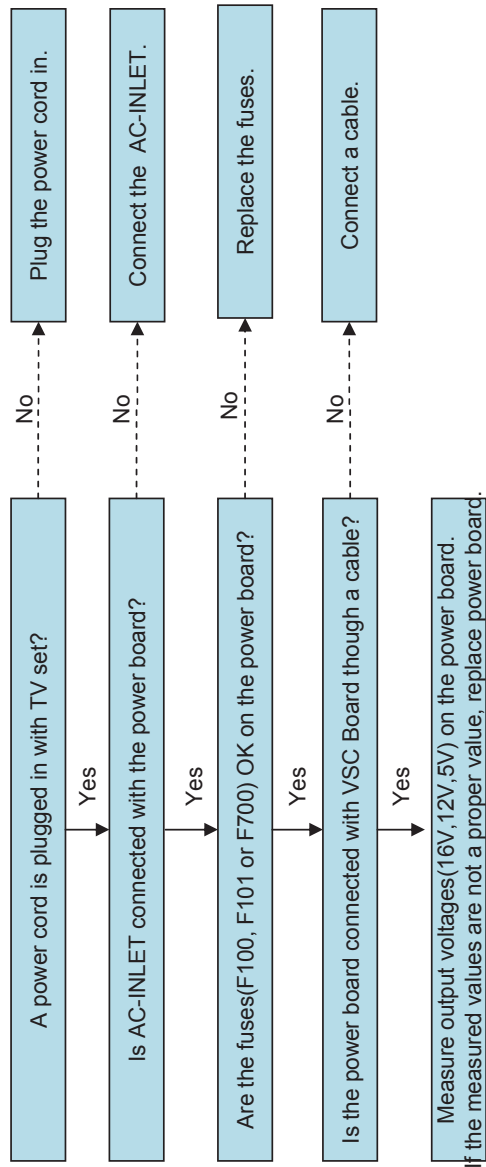



### 3. No Raster

#### Symptom

- 1) No OSD and image occur on the screen.
- 2) It maintains the condition with the front LED is white.

#### Check the followings

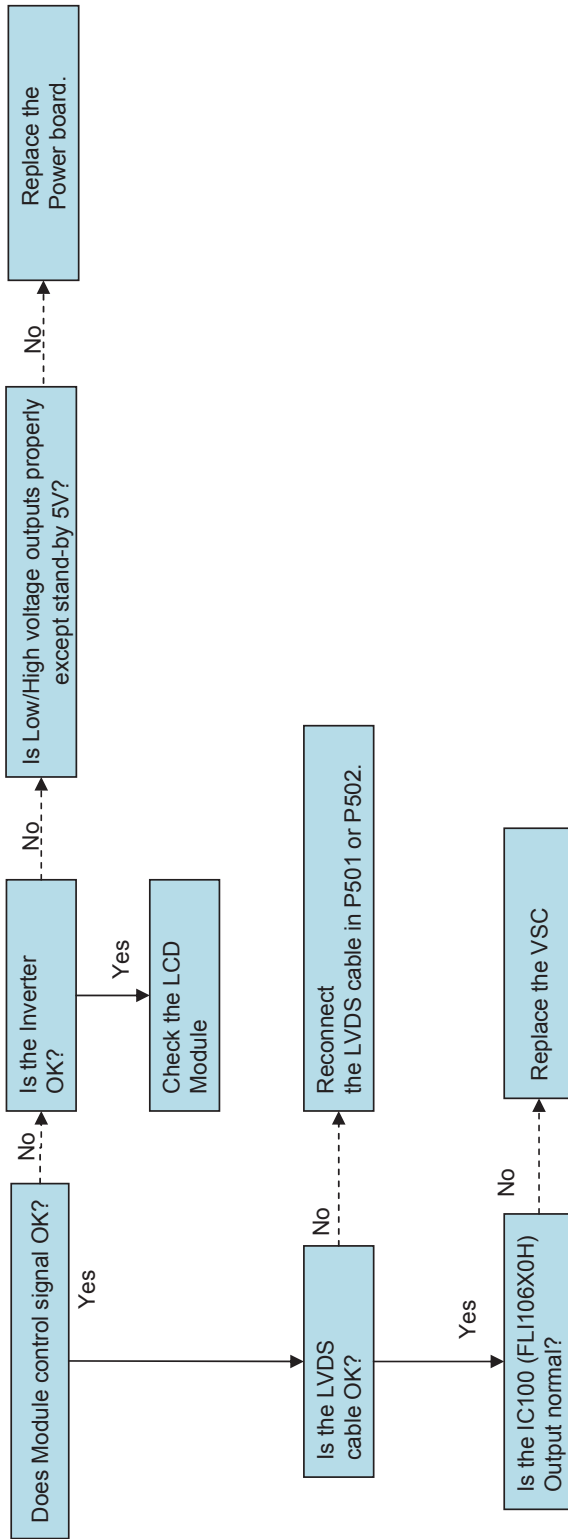

#### 4. In case of occur strange screen into specific mode

##### 1) In case of abnormal OSD display

###### Symptom

- 1) LED is white
- 2) The minute discharge continuously becomes accomplished from module

###### Check the followings

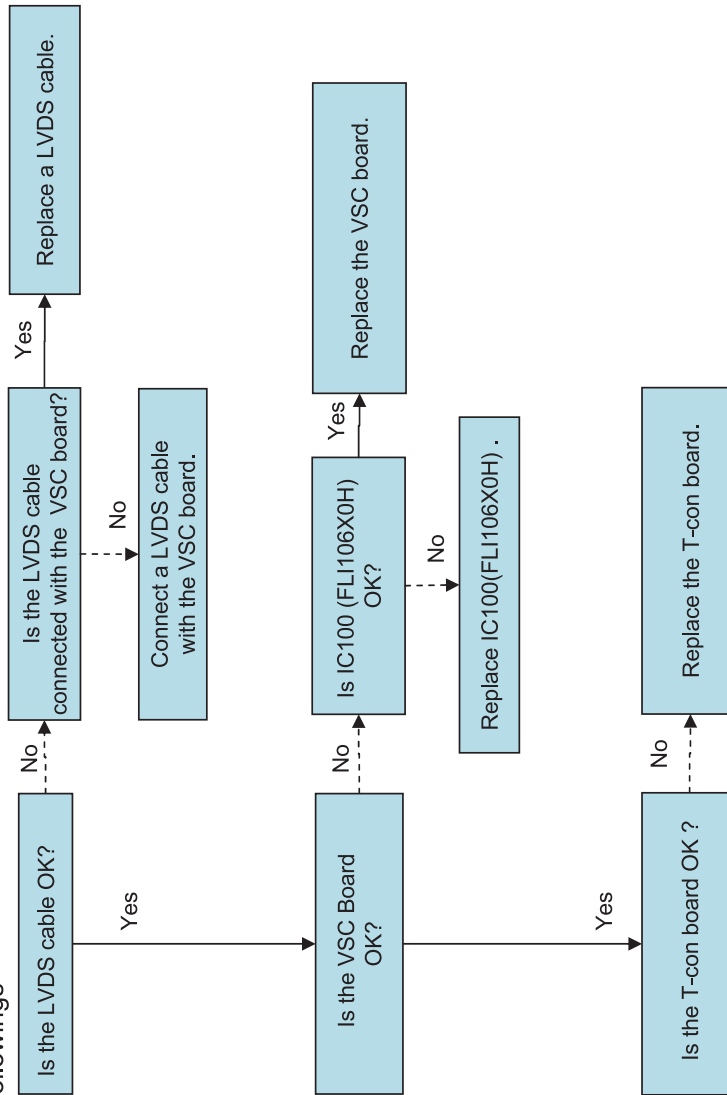

2) In case of abnormal display on the screen in specific mode

Symptom

- 1) The screen does not display the picture from specific input mode (RF,DTV, AV, Component, RGB, HDMI).

Check the followings

In case of abnormal display on the screen when RF mode.

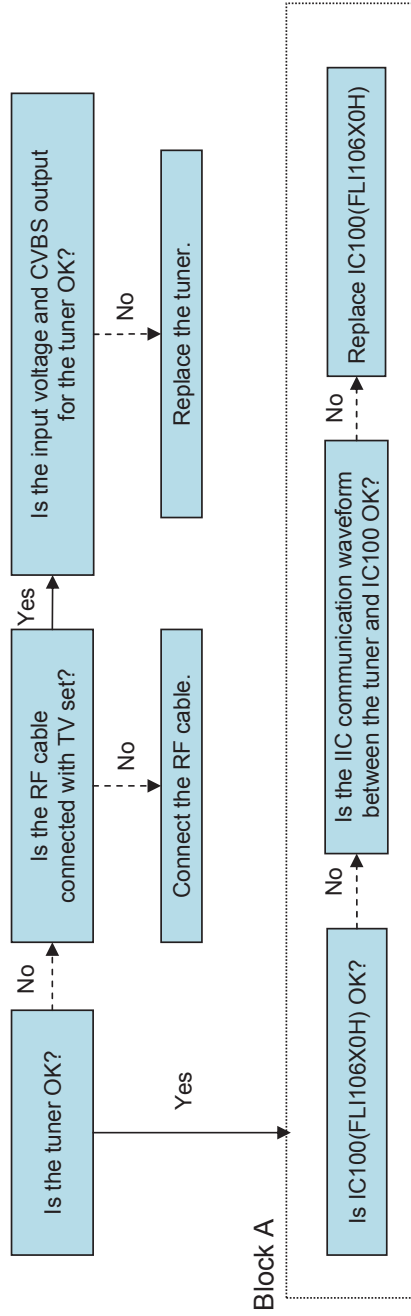

In the case of abnormal display on the screen when USB mode.

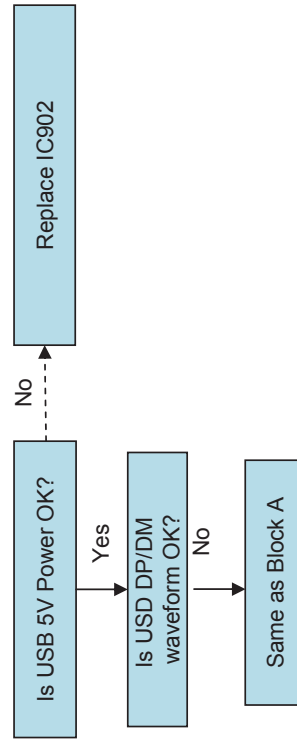

In the case of abnormal display on the screen when side AV1,2 / AV3 mode.

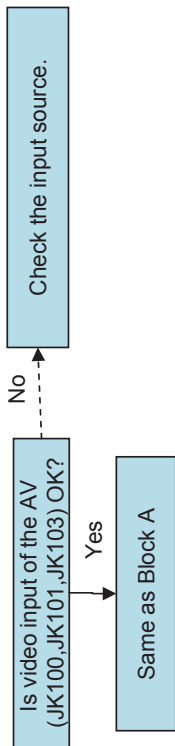

In the case of abnormal display on the screen when Component, RGB mode.

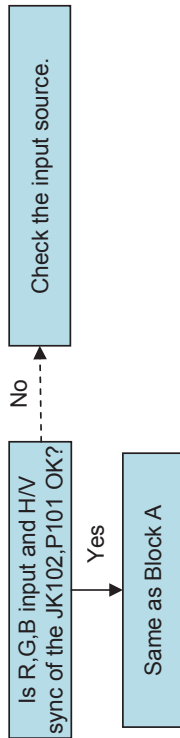

In the case of abnormal display on the screen when HDMI1,2,3 mode.

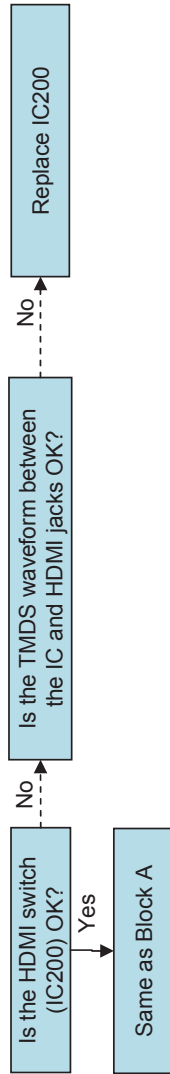

In the case of abnormal display on the screen when HDMI4 mode.

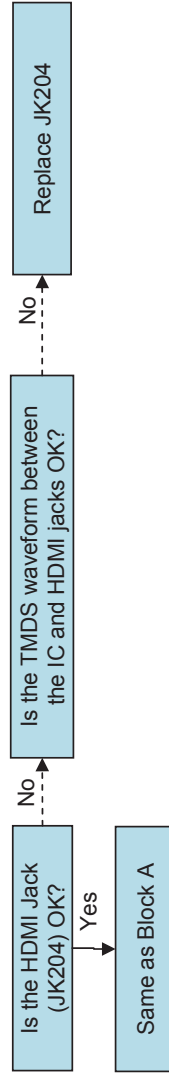

## 5. In case of no sound

### Symptom

- 1) LED is green
- 2) Screen display but sound is not output

### Check follow

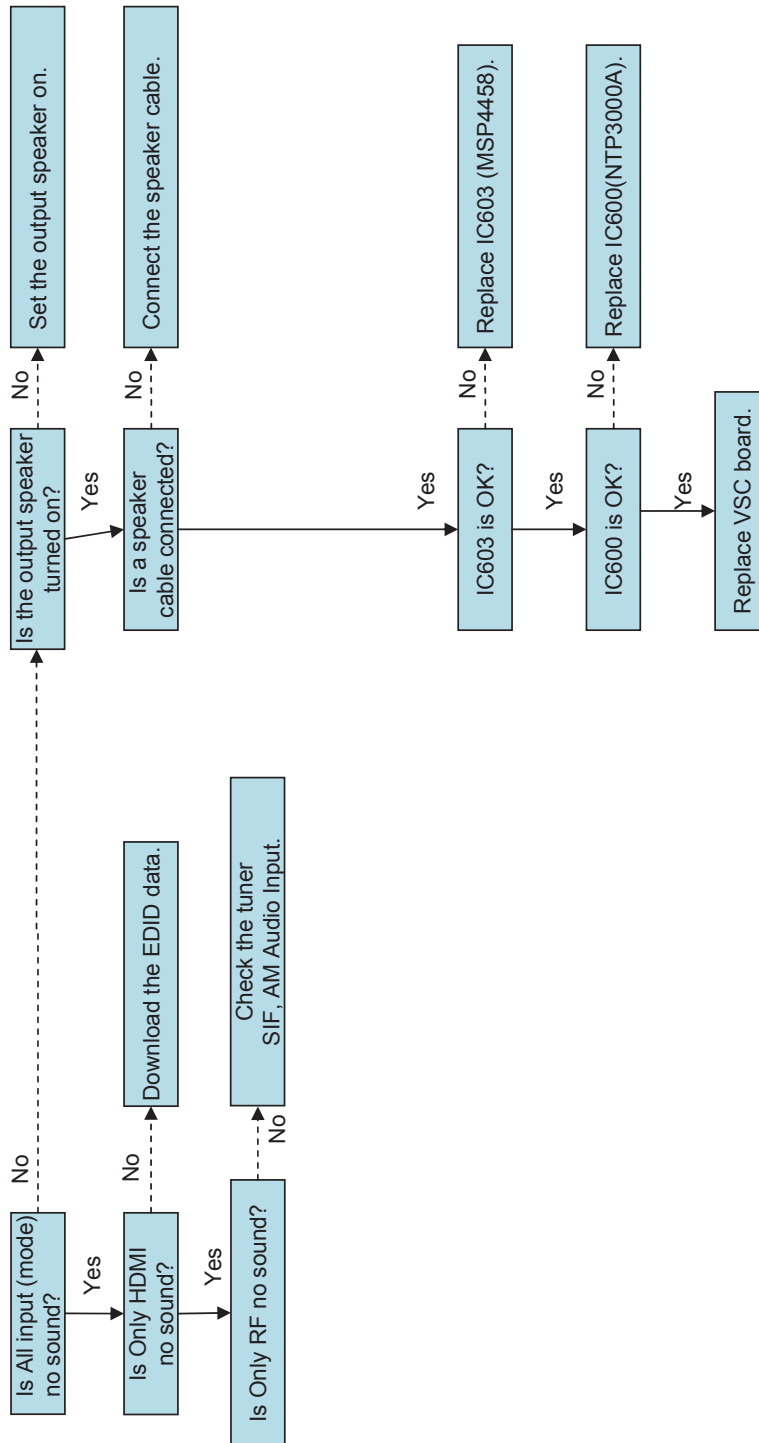



# EXPLODED VIEW

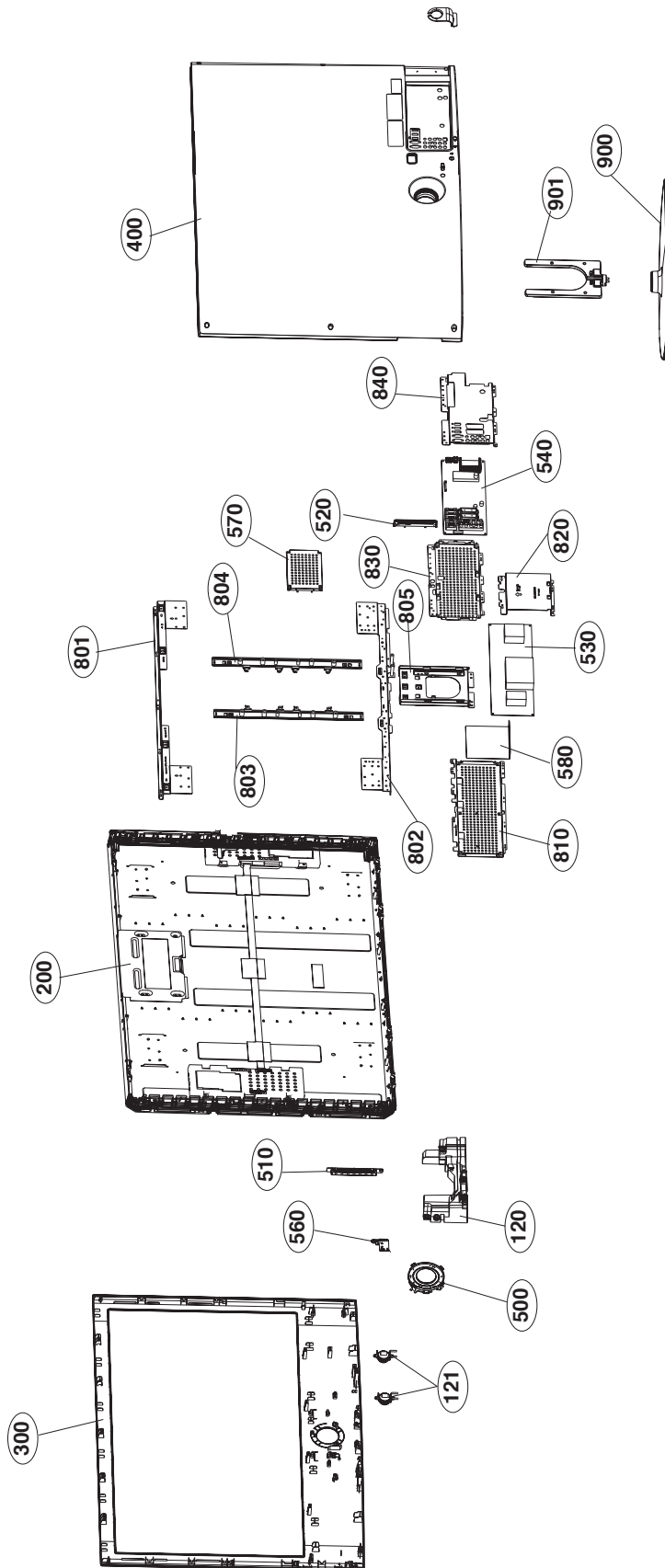











P/NO : MFL41557601

Jan., 2008  
Printed in Korea