



website:<http://biz.LGservice.com>
e-mail:<http://www.LGservice.com/techsup.html>

PLASMA TV

SERVICE MANUAL

CHASSIS : PP61A

MODEL : 42PC1RV/RVA
42PC1RV/RVA-ZJ

CAUTION

BEFORE SERVICING THE CHASSIS,
READ THE SAFETY PRECAUTIONS IN THIS MANUAL.

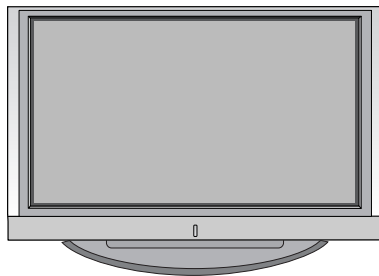

CONTENTS

SAFETY PRECAUTIONS	3
DESCRIPTION OF CONTROLS	4
SPECIFICATIONS.....	9
ADJUSTMENT INSTRUCTIONS	11
TROUBLE SHOOTING GUIDE	16
PRINTED CIRCUIT DIAGRAM	26
BLOCK DIAGRAM.....	29
EXPLODED VIEW	30
EXPLODED VIEW PARTS LIST	31
REPLACEMENT PARTS LIST.....	32
SCHEMATIC DIAGRAM.....	

SAFETY PRECAUTIONS

IMPORTANT SAFETY NOTICE

Many electrical and mechanical parts in this chassis have special safety-related characteristics. These parts are identified by \triangle in the Schematic Diagram and Replacement Parts List.

It is essential that these special safety parts should be replaced with the same components as recommended in this manual to prevent X-RADIATION, Shock, Fire, or other Hazards.

Do not modify the original design without permission of manufacturer.

General Guidance

An **isolation Transformer should always be used** during the servicing of a receiver whose chassis is not isolated from the AC power line. Use a transformer of adequate power rating as this protects the technician from accidents resulting in personal injury from electrical shocks.

It will also protect the receiver and its components from being damaged by accidental shorts of the circuitry that may be inadvertently introduced during the service operation.

If any fuse (or Fusible Resistor) in this monitor is blown, replace it with the specified.

When replacing a high wattage resistor (Oxide Metal Film Resistor, over 1W), keep the resistor 10mm away from PCB.

Keep wires away from high voltage or high temperature parts.

Due to high vacuum and large surface area of picture tube, extreme care should be used in **handling the Picture Tube**. Do not lift the Picture tube by its Neck.

Leakage Current Cold Check(Antenna Cold Check)

With the instrument AC plug removed from AC source, connect an electrical jumper across the two AC plug prongs. Place the AC switch in the on position, connect one lead of ohm-meter to the AC plug prongs tied together and touch other ohm-meter lead in turn to each exposed metallic parts such as antenna terminals, phone jacks, etc.

If the exposed metallic part has a return path to the chassis, the measured resistance should be between $1M\Omega$ and $5.2M\Omega$.

When the exposed metal has no return path to the chassis the reading must be infinite.

An other abnormality exists that must be corrected before the receiver is returned to the customer.

Leakage Current Hot Check (See below Figure)

Plug the AC cord directly into the AC outlet.

Do not use a line Isolation Transformer during this check.

Connect 1.5K/10watt resistor in parallel with a 0.15uF capacitor between a known good earth ground (Water Pipe, Conduit, etc.) and the exposed metallic parts.

Measure the AC voltage across the resistor using AC voltmeter with 1000 ohms/volt or more sensitivity.

Reverse plug the AC cord into the AC outlet and repeat AC voltage measurements for each exposed metallic part. Any voltage measured must not exceed 0.75 volt RMS which corresponds to 0.5mA.

In case any measurement is out of the limits specified, there is possibility of shock hazard and the set must be checked and repaired before it is returned to the customer.

Leakage Current Hot Check circuit

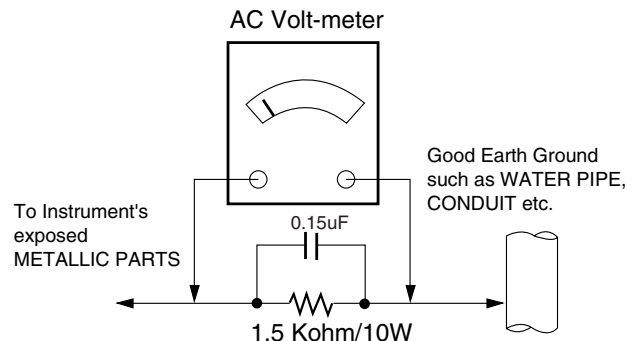

DESCRIPTION OF CONTROLS

POWER Switches the set on from standby or off to standby.

TV INPUT Returns from **AV1, AV2, S-Video2, AV3, AV4**(except 42PC3RV*), **Component, RGB, HDMI1/DVI** or **HDMI 2** to the TV mode. Switches the set on from standby.

INPUT If you press the button once, the input source OSD will appear on screen as shown. Press the **▲ / ▼** button and then **OK** button to select the desired input source (**TV, AV1, AV2, S-Video2, AV3, AV4**(except 42PC3R*), **Component, RGB, HDMI1/DVI** or **HDMI 2**).

ARC Selects your desired picture format.

Brightness adjustment Adjusts screen brightness. It returns to the default settings brightness by changing mode source.

Coloured buttons These buttons are used for teletext (only **TELETEXT** models) or **Programme edit**.

PIP Switches the sub picture PIP, DW, POP or off mode.

SIZE Adjusts the sub picture size.

POSITION Moves the sub picture.

PIP PR - / + Selects a programme for the sub picture.

PIP INPUT Selects the input source for the sub picture in PIP/Twin picture mode.

VCR/DVD control buttons Controls some video cassette recorders or DVD players when you have already selected DVD or VCR mode button.

EXIT Clears all on-screen displays and returns to TV viewing from any menu.

LIST Displays the programme table.

MENU Selects a menu.

I/II Selects the sound output.

SLEEP Sets the sleep timer.



- MODE Selects the remote operating modes.
- 1** TELETEXT BUTTONS These buttons are used for teletext. For further details, see the 'Teletext' section.
- THUMBSTICK (Up/Down/Left Right/ENTER) Allows you to navigate the on-screen menus and adjust the system settings to your preference.
 - OK Accepts your selection or displays the current mode.
- VOLUME UP /DOWN Adjusts the volume.
 - Q.VIEW Returns to the previously viewed programme.
 - MUTE Switches the sound on or off.
 - Programme UP/DOWN Selects available programmes.
 - 0~9 number button Selects a programme. Selects numbered items in a menu.
 - FAV Displays the selected favourite programme.
 - * No function

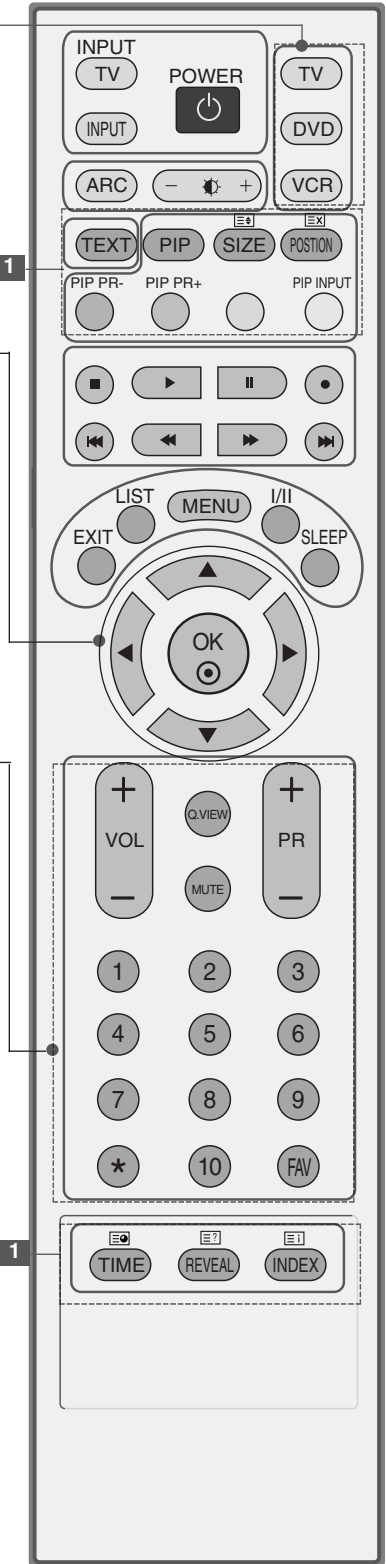

Front Panel Controls

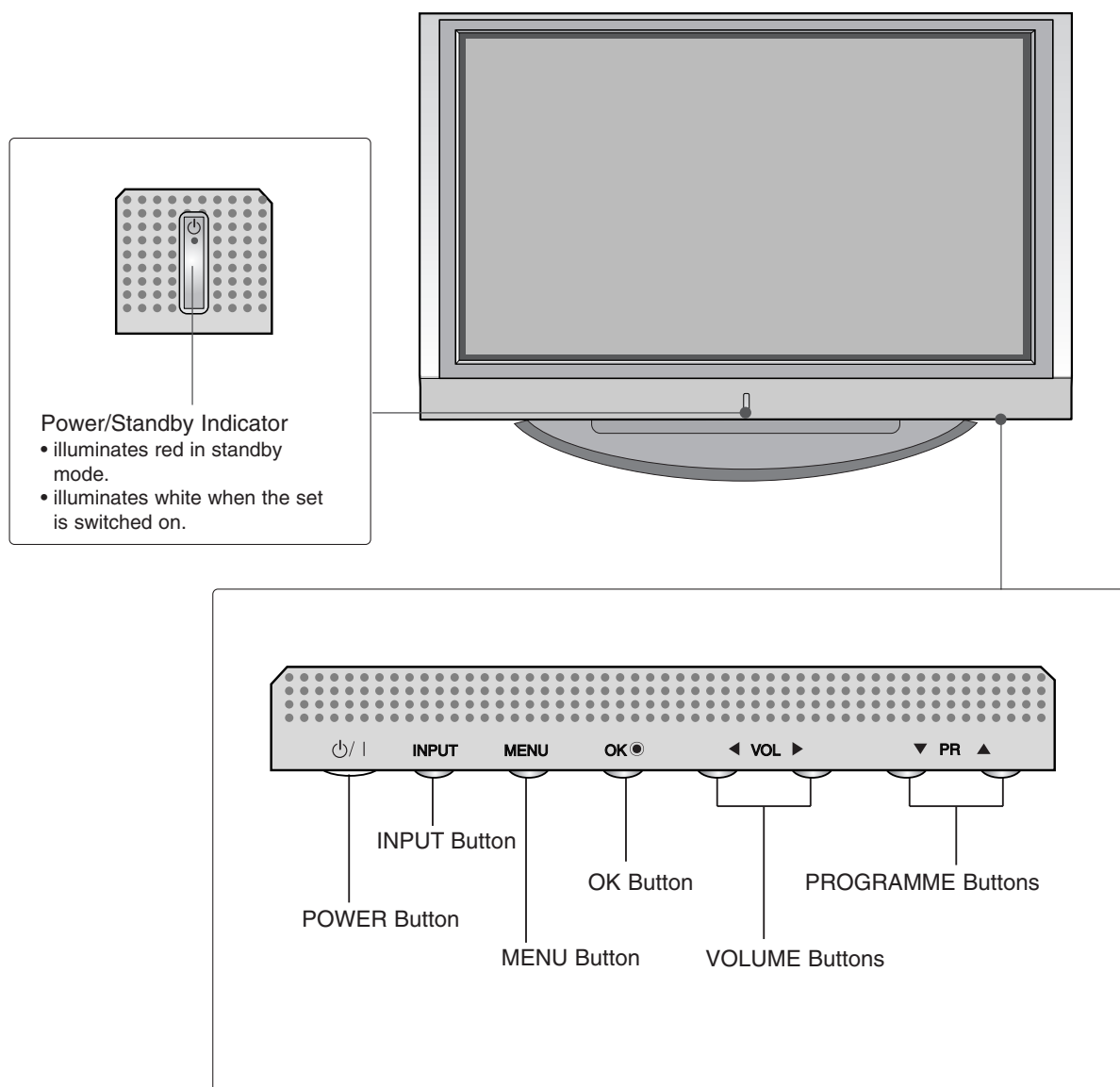

Back Connection Panel

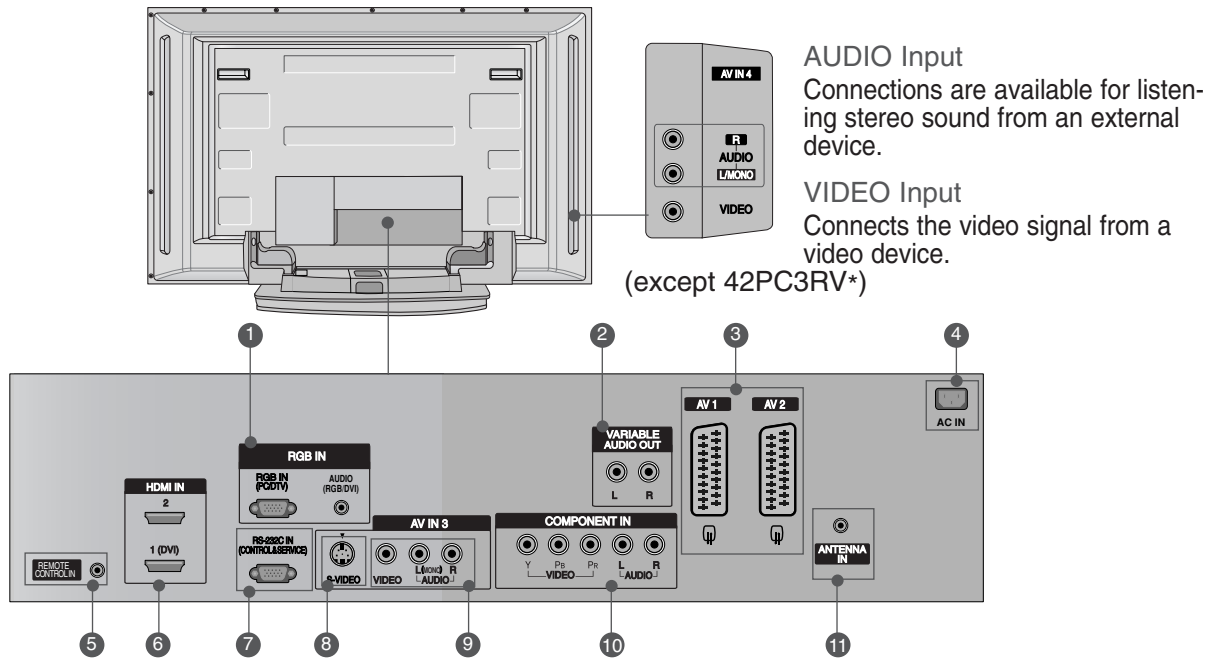

- 1** RGB/Audio Input
Connect the monitor output from a PC/DTV to the appropriate input port.
- 2** Variable Audio Output
Connect an external amplifier or add a subwoofer to your surround sound system.
- 3** Euro Scart Socket (AV1/AV2)
Connect scart socket input or output from an external device to these jacks.
- 4** Power Cord Socket
This TV operates on an AC power. The voltage is indicated on the Specifications page. Never attempt to operate the TV on DC power.
- 5** Remote Control Port
- 6** HDMI Input
Connect a HDMI signal to HDMI IN. Connect DVI(VIDEO) signal to HDMI/DVI port with DVI to HDMI cable.
- 7** RS-232C Input(CONTROL&SERVICE)Port
Connect the serial port of the control devices to the RS-232C jack.
- 8** S-Video Input
Connect S-Video out from an S-VIDEO device.
- 9** Audio/Video Input
Connect audio/video output from an external device to these jacks.
- 10** Component Input
Connect a component video/audio device to these jacks.
- 11** Antenna Input

ACCESSORIES

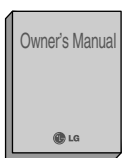

Owner's Manual

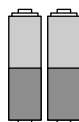

Batteries

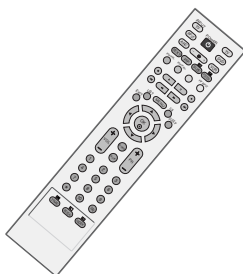

Remote Control

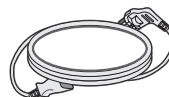

Power Cord

For 42PC1R*, 42PC3R*



2-Wall brackets



2-eye-bolts



2-bolt for stand assembly

STAND INSTALLATION (OPTION)

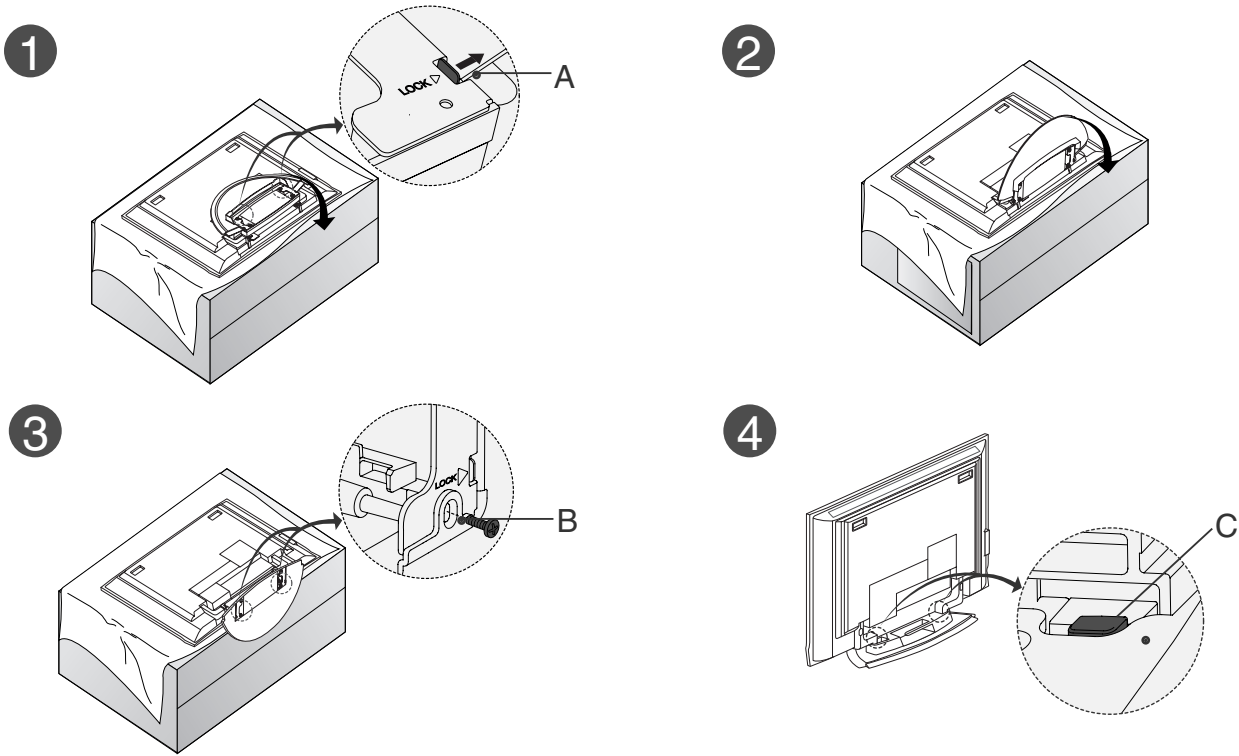

- Place the set with the screen facing down on a cushion or soft cloth as shown in Figures 1. Before unfolding the stand, please make sure two locks (A) on the bottom of the stand push outward.
- Pull the stand out as shown above in Figures 2 ~ 3. After unfolding the stand, please insert and tighten the screws in the holes (B) on the bottom of the stand.
- When connecting cables to the set, Do not disengage the lock (C). This may cause the set to fall, causing serious bodily injury and serious damage to the set.

* NOTE

Figures shown here may be slightly different from your set.

When closing the stand for storage

First remove the screws in the holes (B) on the bottom of the stand. And then pull two Hooks (D) of the stand bottom and fold the stand into the back of the set.

After folding, push two Locks (A) of the stand bottom outward.

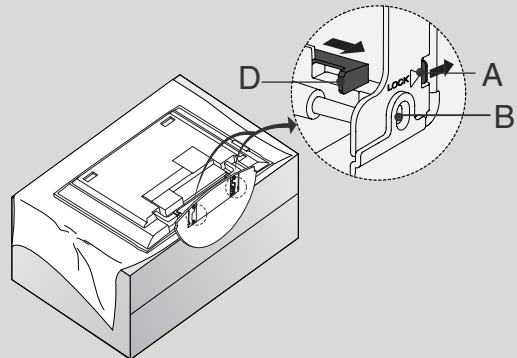

SPECIFICATIONS

NOTE : Specifications and others are subject to change without notice for improvement.

■ Application Range

This spec is applied to the 42" PDP TV used PP61A Chassis.

Chassis	Model Name	Market Place	Brand	Remark
PP61A	42PC1RV/RVA-ZJ	EU	LG	

■ Specification

Each part is tested as below without special appointment.

- 1) Temperature : 25±5°C (77±9°F), CST : 40±5
- 2) Relative Humidity: 65±10%
- 3) Power Voltage: Standard Input voltage (100-240V~, 50/60Hz)
* Standard Voltage of each product is marked by models.
- 4) Specification and performance of each parts are followed each drawing and specification by part number in accordance with BOM.
- 5) The receiver must be operated for about 20 minutes prior to the adjustment.

■ Test Method

- 1) Performance : LGE TV test method followed.
- 2) Demanded other specification
Safety : CE, IEC specification
EMC : CE, IEC

Model	Market	Appliance
42PC1RV/RVA-ZJ	EU	Safety : IEC/EN60065, EMI : EN55013, EMS : EN55020

■ General Specification

1. Module Specification(42"VGA(V8) MODULE)

No	Item	Specification	Remark
1	Display Screen Device	42 inch wide Color Display Module	PDP
2	Aspect Ratio	16:9	
3	PDP Module	PDP42V8, RGB Closed Type	Film Filter
4	Operating Environment	1)Temp. : 0~40deg 2)Humidity : 0~85%	LGE SPEC.
5	Storage Environment	3)Temp. : -20~60deg 4)Humidity : 0~85%	
6	Input Voltage	AC100~240V, 50/60Hz	Maker : LG

2. Model General Specification

No	Item	Specification			Remark
1	Market	EU			
2	Broadcasting system	PAL-BG//DK, NTSC			
3	Available Channel	BAND	PAL	NTSC	
		VHF/UHF	C1~C69	2~83	
		CATV	S1~S47	1~71	
4	Receiving system	Upper Heterodyne			
5	SCART Jack(2EA)	PAL, SECAM, NTSC			4 System : PAL, SECAM, NTSC, PAL60
6	Video Input (2EA)	PAL, SECAM, NTSC			4 System : PAL, SECAM, NTSC, PAL60
7	S-Video Input (1EA)	PAL, SECAM, NTSC			4 System : PAL, SECAM, NTSC, PAL60
8	Component Input (1EA)	Y/Cb/Cr, Y/Pb/Pr			
9	RGB Input(1EA)	RGB-PC, RGB-DTV			
10	HDMI Input(1EA)	HDMI-DTV			
11	Audio Input (4EA)	PC Audio, Component(1EA), AV (2EA)			L/R Input
12	Wired Control(1EA)				
13	Audio variable out(1EA)				

ADJUSTMENT INSTRUCTIONS

1. Application Object

These instructions is applied all of the 42" PDP TV, PP61A Chassis.

2. Specification

- (1) Because this is not a hot chassis, it is not necessary to use an isolation transformer. However, the use of isolation transformer will help protect test instrument.
- (2) Adjustment must be done in the correct order.
- (3) The adjustment must be performed in the circumstance of $25 \pm 5^\circ\text{C}$ of temperature and $65 \pm 10\%$ of relative humidity if there is no specific designation.
- (4) The input voltage of the receiver must keep 100-220V, 50/60Hz.
- (5) The receiver must be operated for about 15 minutes prior to the adjustment.

- After RGB Full white HEAT-RUN Mode, the receiver must be operated prior to adjustment.
- Enter into HEAT-RUN MODE
 - 1) Press the POWER ON KEY on R/C for adjustment.
 - 2) OSD display and screen display PATTERN MODE.

- * Set is activated HEAT-RUN without signal generator in this mode.
- * Single color pattern(RED/BLUE/GREEN) of HEAT-RUN mode uses to check PANEL.

Caution) If you turn on a still screen more than 20 minutes, (Especially digital pattern, cross hatch pattern) after image may be occur in the black level part of the screen.

3. S/W program download

3-1. Preliminary steps

- (1) Connect the download jig to D-sub jack.
- (2) Connect SCL with GND using switch at Jig.
- (3) Supply 5V and GND at PCB assembly.
- (4) Wait 3 second.
- (5) Disconnect SCL with GND using switch at Jig.
- (6) Execute 'vct69xyp_main_graphic.vi2c' program in PC, then a main widow will be opened.

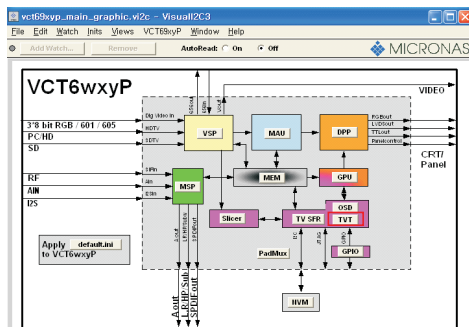

(7) Click "TVT" button, then the TVT window will be opened.

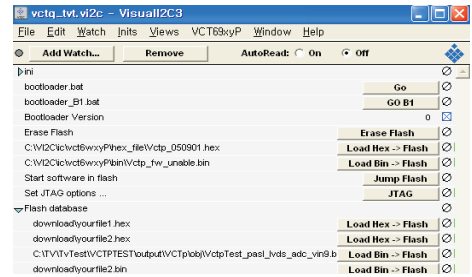

(8) Double click the blue box and confirm "Bootloader Version" as 40.

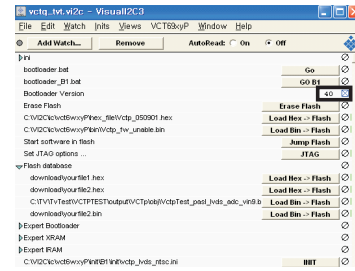

(9) Click the "Erase Flash" button.

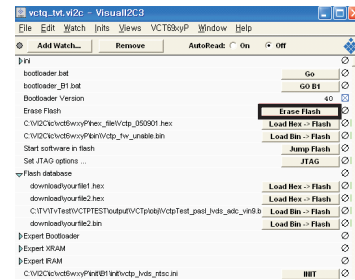

(10) Double click the download file low then, "edit" window will be opened.

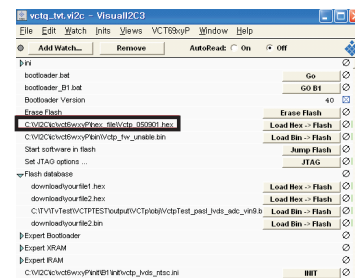

(11) Chck the choice button I n the "edit window", then "file choice window" will be opened.

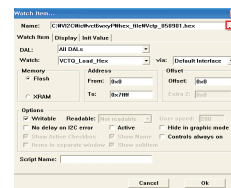

(12) Choose the Hex file in folder and execute downloading with click "open button".

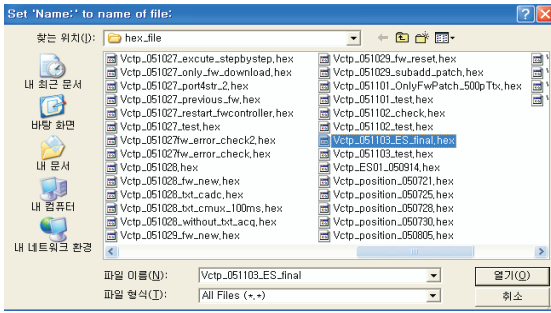

(13) Click OK button at the "edit window".

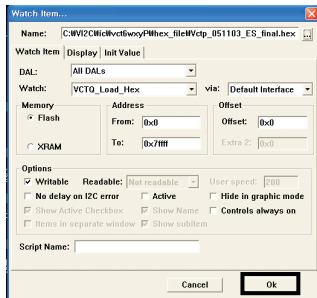

(14) Under Downloading progress.



(15) If download is failed, for example "No acknowledge from slave", execute download again from (1).

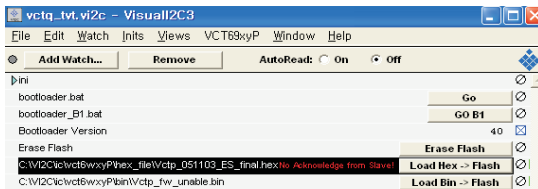

4. Channel memory download

(1) Push the NVM button.

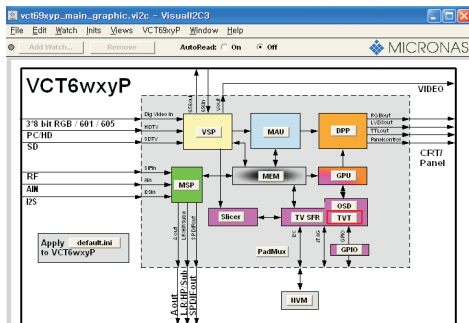

(2) Push the button change and select the Channel memory data.

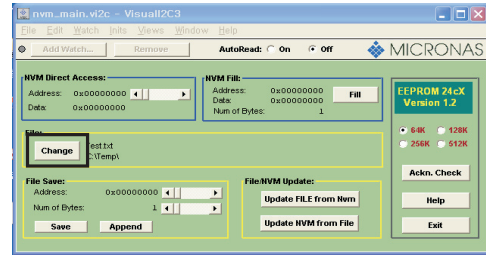

(3) Push the Update NVM from File.

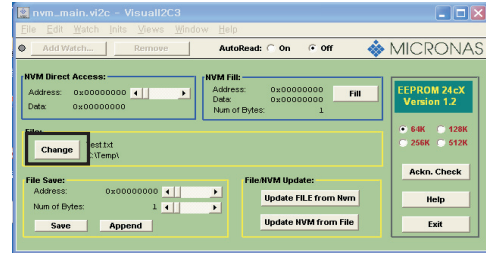

5. POWER PCB Assy Voltage Adjustments (Va, Vs Voltage adjustments)

5-1. Test Equipment : D.M.M. 1EA

5-2. Connection Diagram for Measuring : refer to Fig.1

5-3. Adjustment Method (Power board - P/N : 6709900019A)
(1) Va Adjustment

- 1) After receiving 100% Full White Pattern, HEAT RUN.
- 2) Connect + terminal of D. M.M. to Va pin of P812, connect -terminal to GND pin of P812.
- 3) After turning RV901, voltage of D.M.M adjustment as same as Va voltage which on label of panel right/top. (deviation; $\pm 0.5V$)

(2) Vs Adjustment

- 1) Connect + terminal of D.M.M. to Vs pin of P851, connect -terminal to GND pin of P812.
- 2) After turning RV 951, voltage of D.M.M adjustment as same as Vs voltage which on label of panel right/top. (deviation ; $\pm 0.5V$)

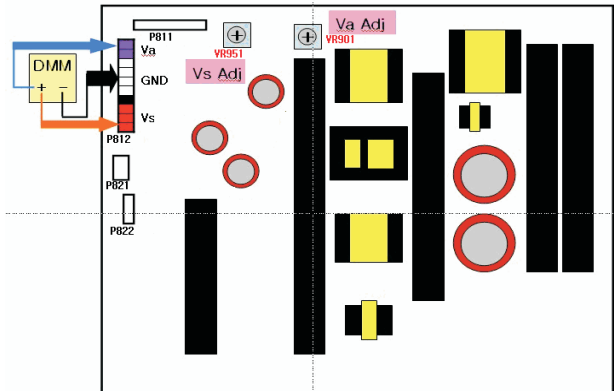

(Fig. 1) Connection diagram of power adjustment for measuring.

6. EDID (The Extended Display Identification Data)/ DDC (Display Data Channel) download

6-1. Required Test Equipment

- 1) Adjusting PC with S/W for writing EDID Data.(S/W : EDID TESTER Ver.2.5).
- 2) A Jig for EDID Download.
- 3) Cable : Serial(9Pin or USB) to D-sub 15Pin cable, D-sub 15Pin cable, DVI to HDMI cable.

6-2. Setting of device

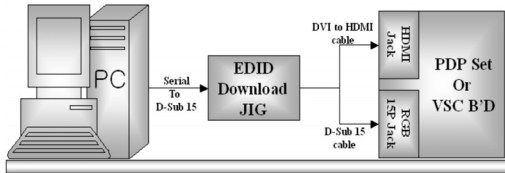

(Fig. 2) Connection Diagram of DDC download

6-3. Preparation for Adjustment

- 1) As above Fig.2, Connect the Set, EDID Download Jig, PC & Cable.
- 2) Turn on the PC & EDID Download Jig. And Execute the S/W : EDID TESTER Ver.,2.5.
- 3) Set up S/W option.

Repeat Number : 5
Device Address : A0
PageByte : 8

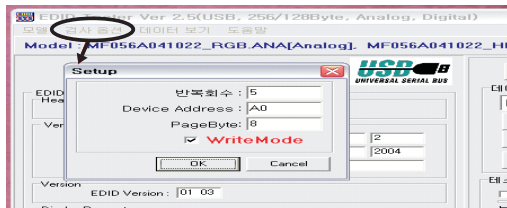

- 4) Power on the Set.

6-4. Sequence of Adjustment

(1) DDC data of Analog-RGB

- 1) Init the data.



- 2) Load the EDID data.(Open File).

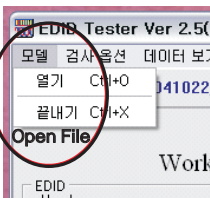

[Analog-RGB : PP61A/C_RGB.ANA]

[Digital-HDMI : PP61A/C_HDMI.DVI]

- 3) Set the S/W as below.

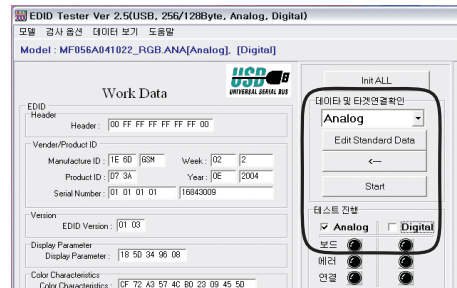

- 4) Push the "Write Data & Verify" button. And confirm "Yes".



- 5) If the writing is finished, you will see the "OK" message.

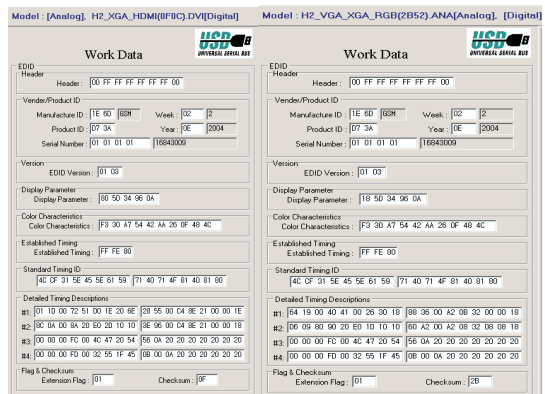

<EDID DATA Analog Set 128bytes> : 42PC(1/3)RV-TJ

00	01	02	03	04	05	06	07	08	09	0A	0B	0C	0D	0E	0F
00	00	FF	FF	FF	FF	FF	FF	00	1E	6D	D7	3A	01	01	01
10	02	10	01	03	18	5C	34	96	0A	F3	30	A7	54	42	AA
20	0F	42	4C	A1	08	00	31	40	01	01	45	40	01	01	61
30	01	01	01	01	01	01	D5	09	80	A0	20	E0	2D	10	08
40	22	00	98	06	32	08	08	18	64	19	00	40	41	00	26
50	18	88	36	00	98	06	32	00	00	18	00	00	00	FC	00
60	47	20	54	56	0A	20	20	20	20	20	20	20	00	00	FD
70	00	30	3E	1E	32	08	00	0A	20	20	20	20	20	20	10
80	02	03	1C	72	23	09	07	02	49	07	16	81	03	05	14
90	12	04	83	01	00	00	65	03	0C	00	10	00	01	1D	80
A0	71	1C	16	20	58	2C	25	00	C4	8E	21	00	00	9E	01
B0	80	D0	72	1C	16	20	10	2C	25	80	C4	8E	21	00	00
C0	01	1D	00	BC	52	D0	1E	20	B8	28	55	40	C4	8E	21
D0	00	1E	8C	0A	D0	90	20	40	31	20	0C	40	55	00	C4
E0	21	00	00	18	01	1D	00	72	51	D0	1E	20	6E	28	55
F0	C4	8E	21	00	00	1E	00	00	00	00	00	00	00	00	2F

<EDID DATA Analog Set 256bytes>

00	01	02	03	04	05	06	07	08	09	0A	0B	0C	0D	0E	0F
00	00	FF	FF	FF	FF	FF	FF	00	1E	6D	D7	3A	01	01	01
10	02	10	01	03	80	3C	34	96	0A	F3	30	A7	54	42	AA
20	0F	48	4C	00	00	00	01	01	01	01	01	01	01	01	01
30	01	01	01	01	01	01	8C	0A	D0	8A	20	B0	2D	10	10
40	96	00	C4	8E	21	00	00	18	00	00	00	FC	00	4C	47
50	54	56	0A	20	20	20	20	20	20	20	00	00	00	FD	00
60	41	19	30	08	00	0A	20	20	20	20	20	00	00	00	00
70	00	00	00	00	00	00	00	00	00	00	00	00	00	00	01
80	02	03	1C	72	23	09	07	02	49	07	16	81	03	05	14
90	12	04	83	01	00	00	65	03	0C	00	10	00	01	1D	80
A0	71	1C	16	20	58	2C	25	00	C4	8E	21	00	00	9E	01
B0	80	D0	72	1C	16	20	10	2C	25	80	C4	8E	21	00	00
C0	01	1D	00	BC	52	D0	1E	20	B8	28	55	40	C4	8E	21
D0	00	1E	8C	0A	D0	90	20	40	31	20	0C	40	55	00	C4
E0	21	00	00	18	01	1D	00	72	51	D0	1E	20	6E	28	55
F0	C4	8E	21	00	00	1E	00	00	00	00	00	00	00	00	2F

7. Adjustment of White Balance

7-1. Required Equipment

- 1) Remote controller for adjustment.
- 2) Color Analyzer (CA-100 or same product).
- 3) Auto W/B adjustment instrument(only for Auto adjustment).
- 4) AV Pattern Generator.

7-2. Connecting diagram of equipment for measuring (For Auto Adjustment)

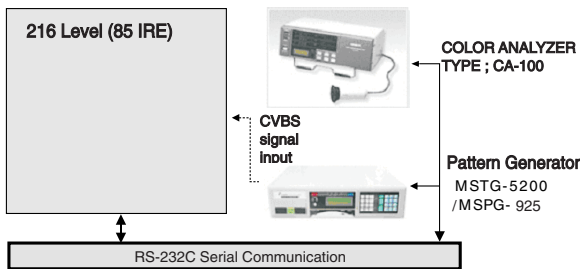

(Fig. 3) Connection Diagram of Auto W/B Adjustment

◆ Auto adjustment Map(RS-232C)

Type		PP61C : 42PC1RV-TJ				
Baud Rate		Data bit		Stop bit		Parity
115200		8		1		NONE
Protocol Setting	Index	Cmd1	Cmd2	Data	Min Value	Max Value
	R Gain	j	a		00(00)	255(FF)
	G Gain	j	b		00(00)	255(FF)
	B Gain	j	c		00(00)	255(FF)
	R Offset	j	d		00(00)	255(FF)
	G Offset	j	e		00(00)	255(FF)
	B Offset	j	f		00(00)	255(FF)

7-3. Adjustment of White Balance (For Manual adjustment)

- Operate the zero-calibration of the CA-100, then stick sensor to PDP module surface when you adjust.
- For manual adjustment, it is also possible by the following sequence.

- 1) Select white pattern of heat-run mode by pressing power on key on remote control for adjustment then operate heat run more than 15 minutes.
- 2) As below Fig.3, Supply 216Level (85 IRE) full screen pattern to Video input.
Side AV type (42PC1R-ZJ : AV3(Input 50Hz), 42PC1RV-TJ : AV1(Input 50Hz), 42PC3RV-TJ : AV1(Input 50Hz))
- 3) Press the TV/AV KEY on R/C for converting input mode.
- 4) Set the PSM to Standard mode in Picture menu.
- 5) Enter the White Balance adjustment mode by pressing the INSTART key twice(White Balance) on R/C.
- 6) Stick sensor to center of the screen and select each items (Red/Green/Blue Gain and Offset) using ▲/▼(CH +/-) key on R/C.
- 7) Adjust Only High Light with R Gain/ B Gain using ◀/▶ (VOL+/-) key on R/C.
- 8) Adjust it until color coordination becomes as below.

[PP61A : 42PC1RV-ZJ/TJ] - VGA 42"

Brightness : High Light : $80 \pm 20 \text{cd/m}^2$
Color-Coordinate : High Light : X : 0.283 ± 0.003
Y : 0.298 ± 0.003

Color Temperature : $9,300^\circ\text{K} \pm 500^\circ\text{K}$

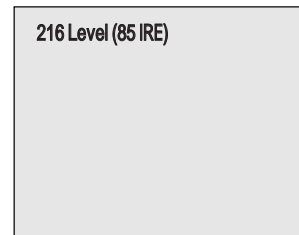

(Fig. 4) Pattern for Adjustment of White Balance

- 9) When adjustment is completed, Exit adjustment mode using EXIT key on R/C.

8. Input the Shipping Option Data

- 1) Push the IN-START key in a Adjust Remocon.
- 2) Input the Option Number that was specified in the BOM, into the Shipping area.
- 3) The work is finished, Push ■ Key.

9. Default value in adjustment mode

9-1. White Balance

White Balance(Hex)		
RED Gain		2A8
Green Gain		2A8
Blue Gain		2A8
Red Offset		00
Green Offset		00
Blue Offset		00
Reset	▶	To Set

(Fig. 5) Default Value on OSD.

10. Power-off History

- 1) This function indicated Power off history.
- 2) You can go into this mode by ADJ key in ADJ remoon.

PP62A Cortez Version 2.02	
Panel Used	9 Hr.
Tool Option1	3
Tool Option2	162
Area Option	20
OPTION1	106
OPTION2	23
OPTION3	2
OPTION4	128
System Control1	
System Control2	
System Control3	
BlkLine Detector	
Power-off History	
Panel Control	
Fan Control	

Power-off History	
Last Power	Remoon
History 1	Remoon
History 2	AC Detect
History 3	Remoon
History 4	AC Detect
History 5	AC Detect
History 6	Fan Alarm
History 7	AC Detect
History 8	Remoon
History 9	Remoon

(Fig. 6) Power-off History.

TROUBLE SHOOTING GUIDE

1. Power Board

1-1. The whole flowchart which it follows in voltage output state

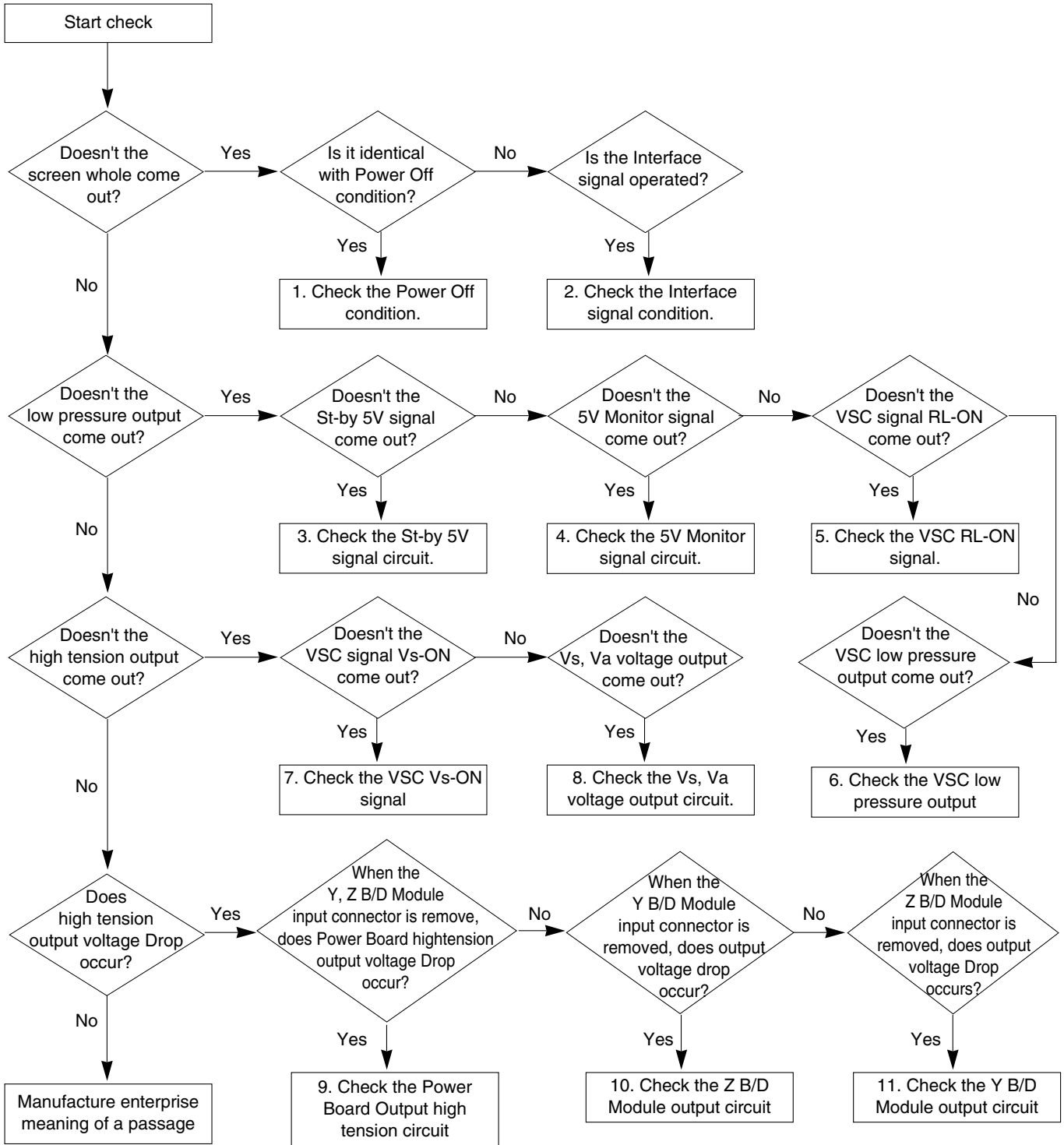

1-2. 42" Power Board Structure

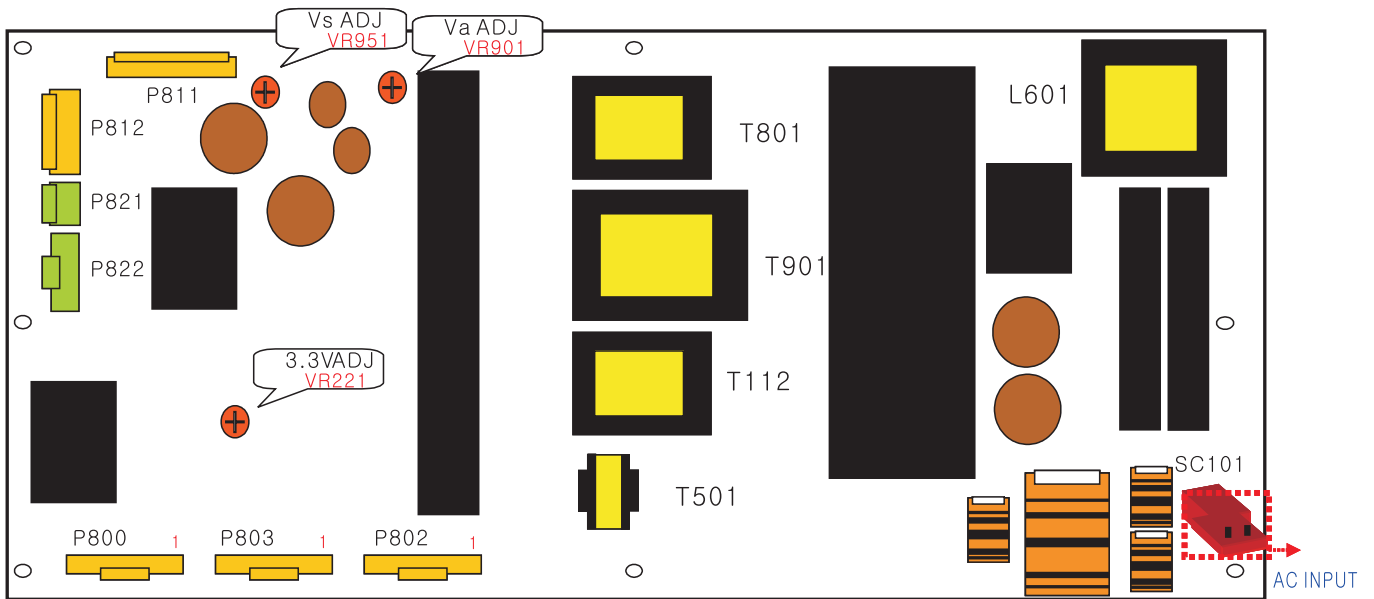

NO	AC INLET	ANALOG & DIGITAL BOARD			PDP MODULE		READY ¹⁾	
	SC1	P800	P803	P802	P811	P812	P821	P822
1	AC	AC Det	19V	3.4V	Vs	5V	5V	GND
2	NC	RL-ON	19V	3.4V	Vs	GND	5V	GND
3	AC	STB 5V	GND	GND	NC	Va	GND	GND
4		GND	GND	GND	GND	GND	GND	GND
5		Vs-ON	6V	6V	GND	GND		5V
6		5V Det	GND	6V	Va	GND		5V
7		3.4VON	3.4V	GND	GND	NC		5V
8		STB 5V	GND	GND	5V	Vs		5V
9		GND	12V	12V		Vs		
10		NC	GND	12V				
11		6V		GND				
12		GND		GND				
13		3.4VON						

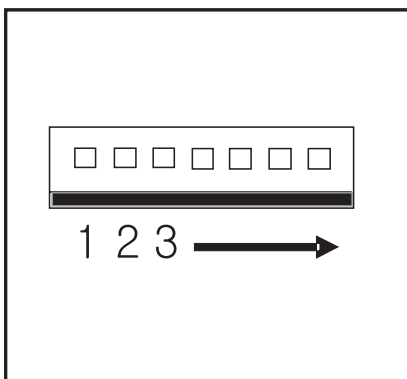

- T801: Vs Trans
- T901: Va Trans
- T112: Low Voltage Trans
- T501: ST-BY Trans
- T601: PFC Inductor

1-3. 50" Power Board Structure

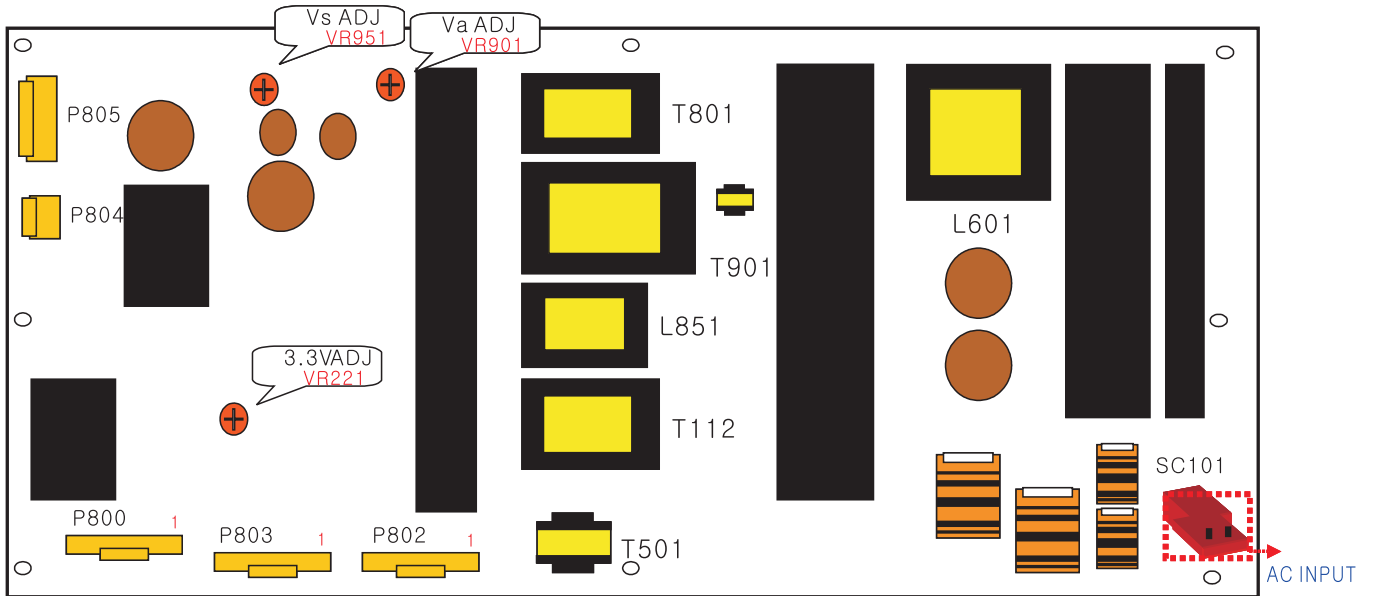

NO	AC INLET	ANALOG & DIGITAL BOARD			PDP MODULE		READY ¹⁾	
	SC1	P800	P803	P802	P811	P812	P821	P822
1	AC	AC Det	19V	3.4V	Vs	5V	5V	GND
2	NC	RL-ON	19V	3.4V	Vs	GND	5V	GND
3	AC	STB 5V	GND	GND	NC	Va	GND	GND
4		GND	GND	GND	GND	GND	GND	GND
5		Vs-ON	6V	6V	GND	GND		5V
6		5V Det	GND	6V	Va	GND		5V
7		3.4V-ON	3.4V	GND	GND	NC		5V
8		STB 5V	GND	GND	5V	Vs		5V
9		GND	12V	12V		Vs		
10		NC	GND	12V				
11		6V		GND				
12		GND		GND				
13		3.4V-ON						

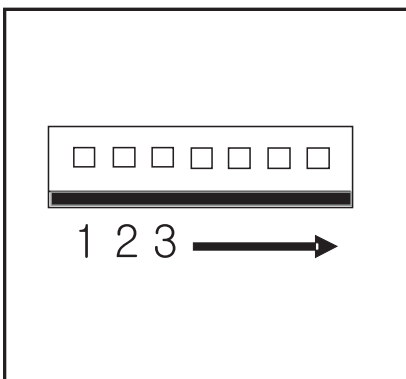

- T801: Vs Trans
- T901: Va Trans
- T902: Vs aux. Trans
- L851: Vs Inductor
- T112: Low Voltage Trans
- T501: ST-BY Trans
- T601: PFC Inductor

2. No Power

(1) Symptom

- 1) Front LED is NO light.
- 2) The Set doesn't discharge little.



(2) Check following

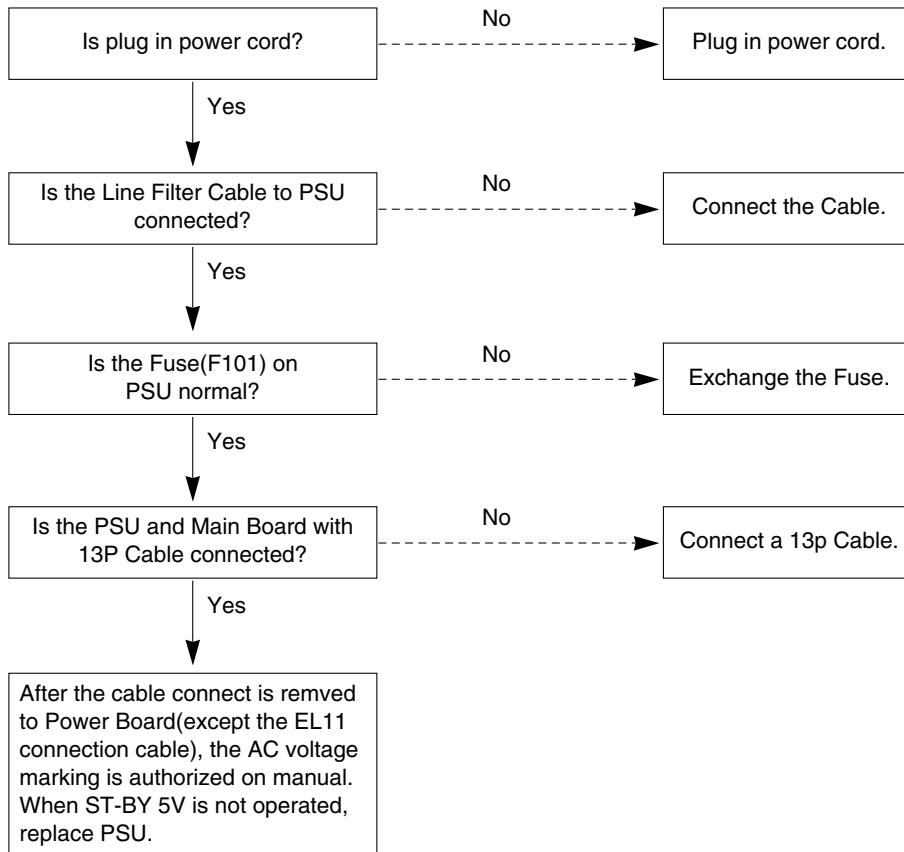

3. No Power

(1) Symptom

- 1) Front LED is NO light.
- 2) The Set doesn't discharge little.



(2) Check following

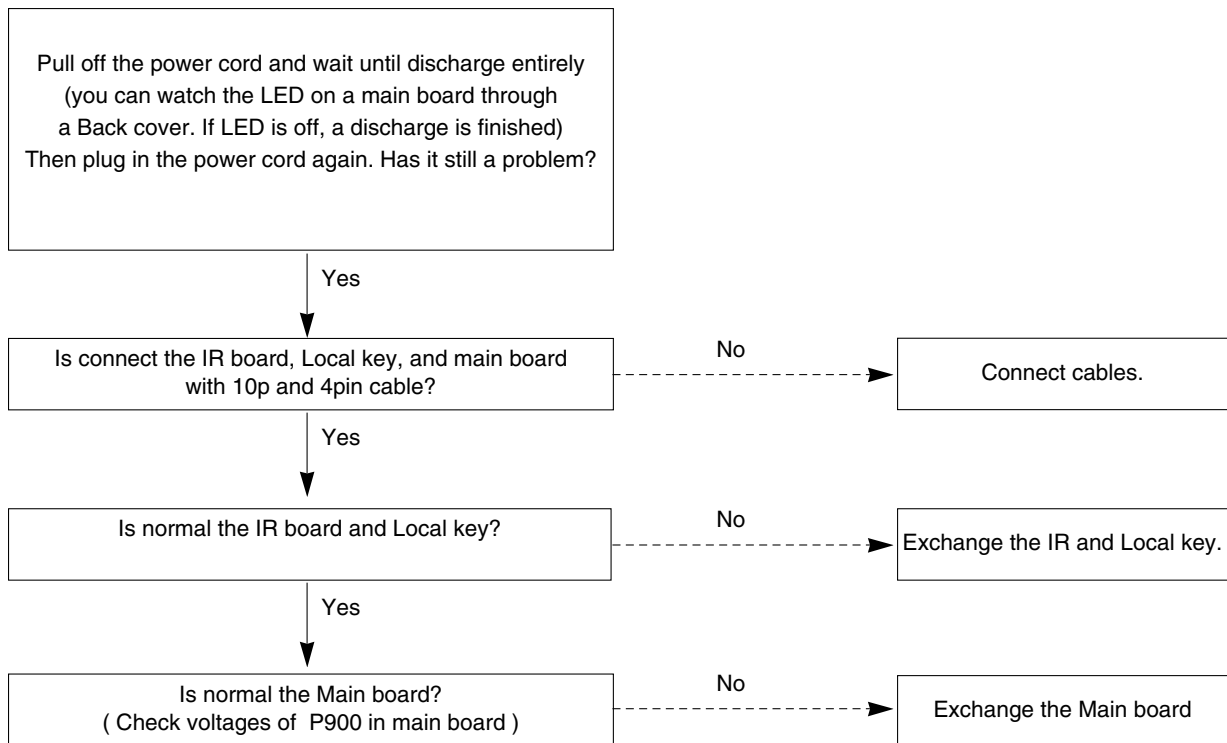

4. Protect Mode

(1) Symptom

- 1) After once shining, it does not discharge minutely from module.
- 2) The Rely falls down.(The sound is audible "click")
- 3) The front LED turn Green to Red.

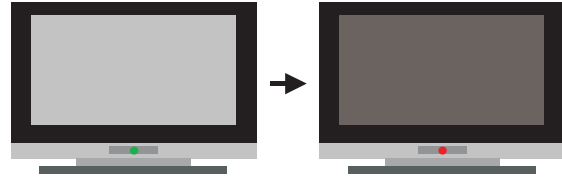

(2) Check following

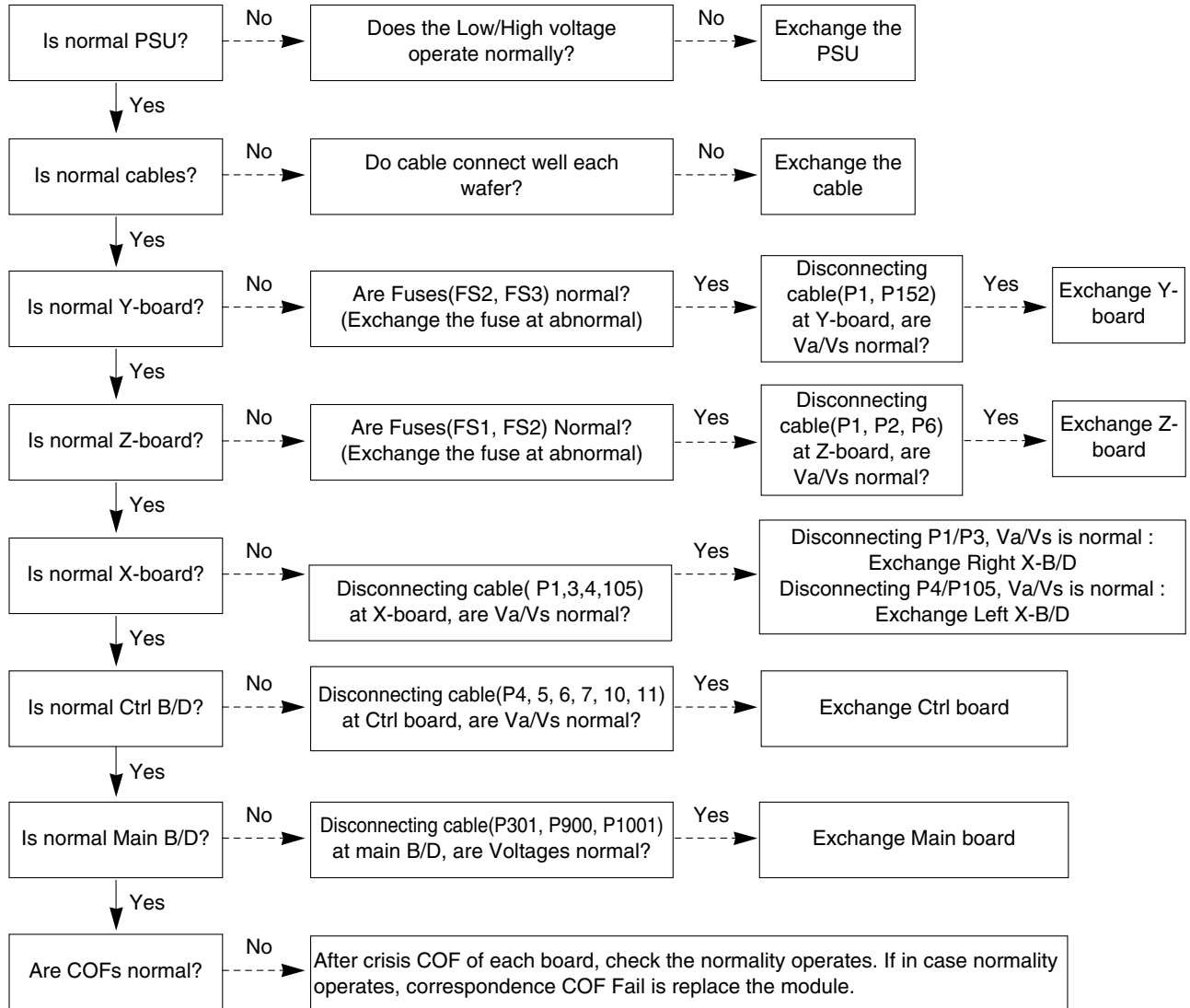

5. No Raster

(1) Symptom

- 1) Front LED is Green.
- 2) The Set doesn't discharge a little.



(2) Check following

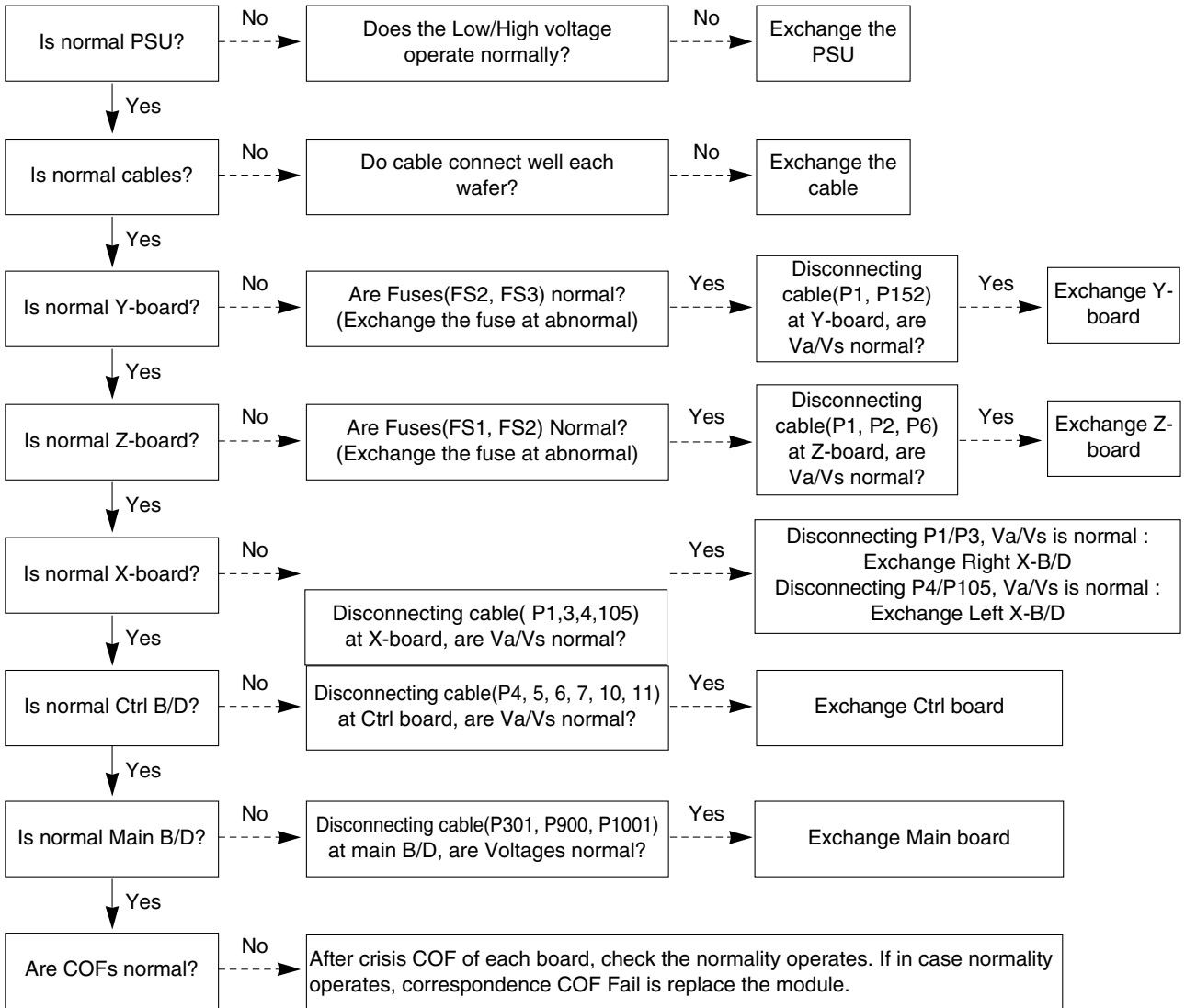

6. No Sound

(1) Symptom

- 1) Front LED is Green.
- 2) The Set display a screen, but a sound doesn't output.



(2) Check following

1) Speaker part

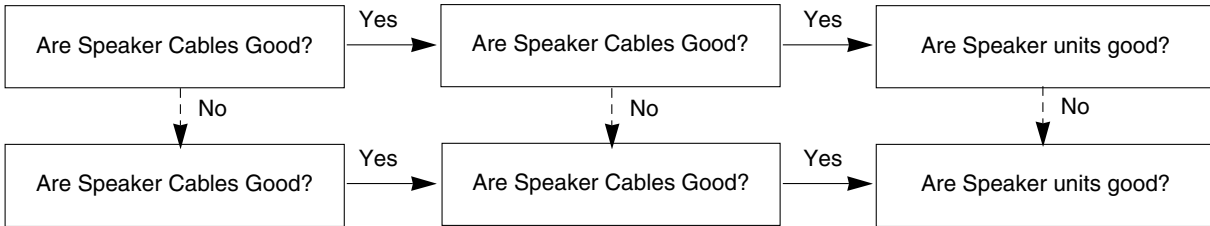

2) Main board part

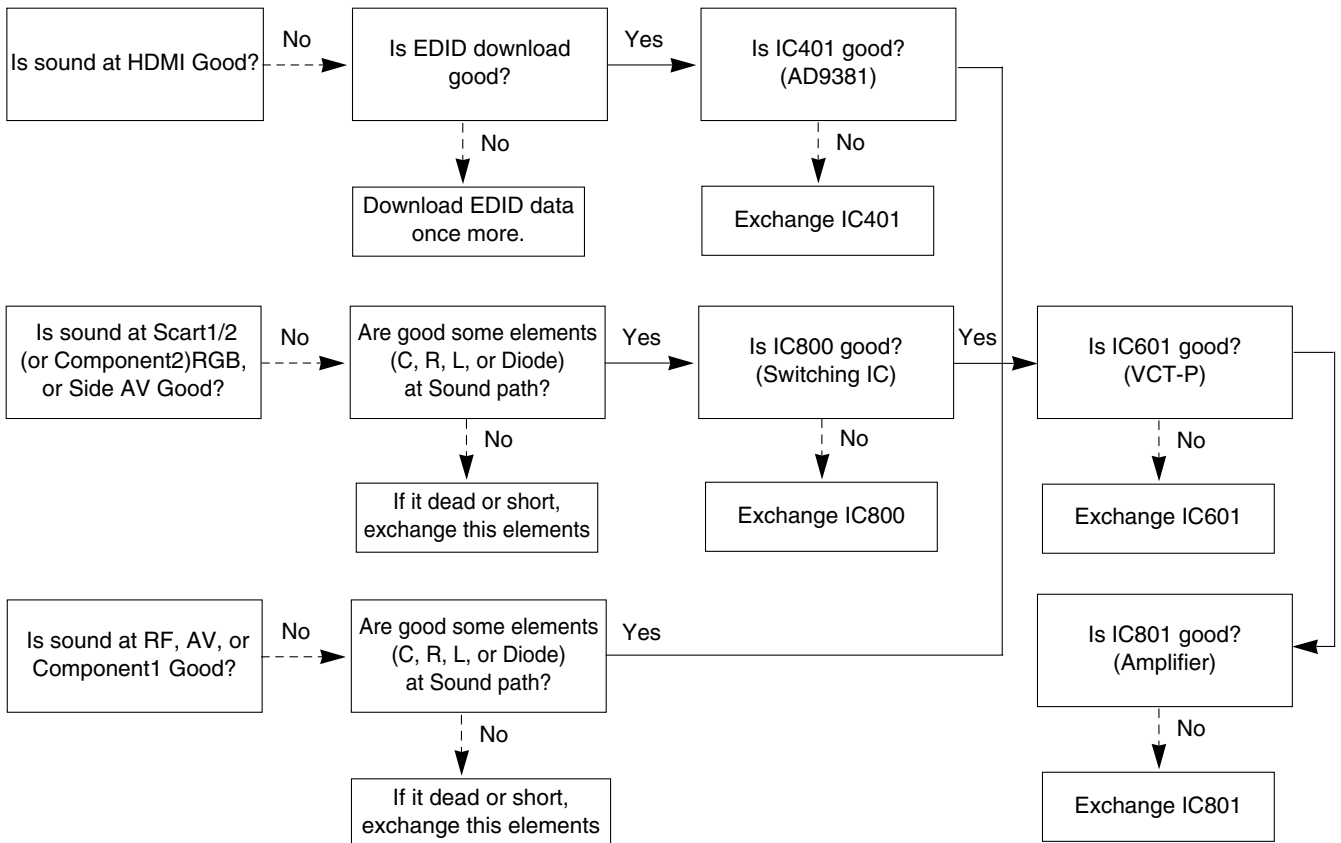

7. Display the screen abnormally

(1) Symptom

1) Display the screen abnormally at specific mode.

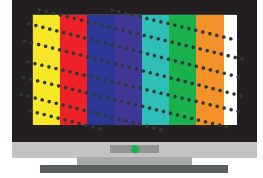

(2) Check following

1) Noise appears at RF mode.

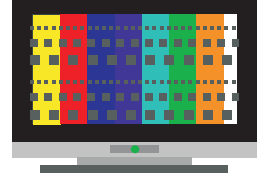
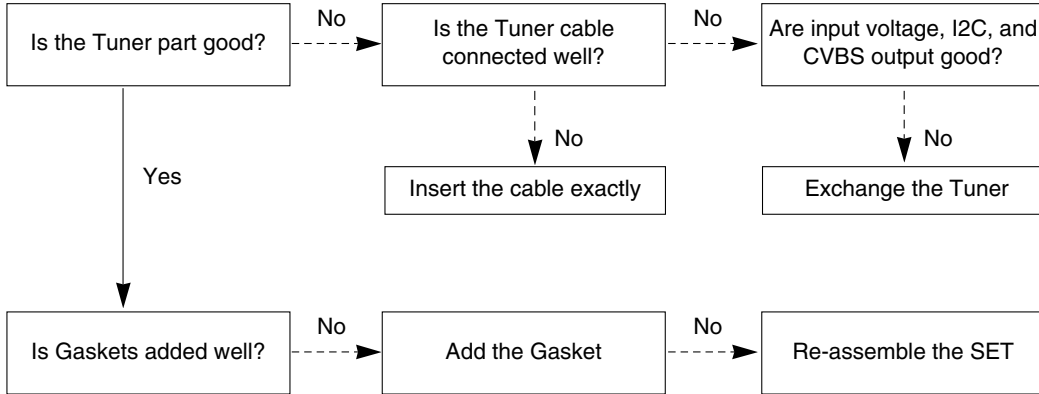

2) Noise appears at Side AV.

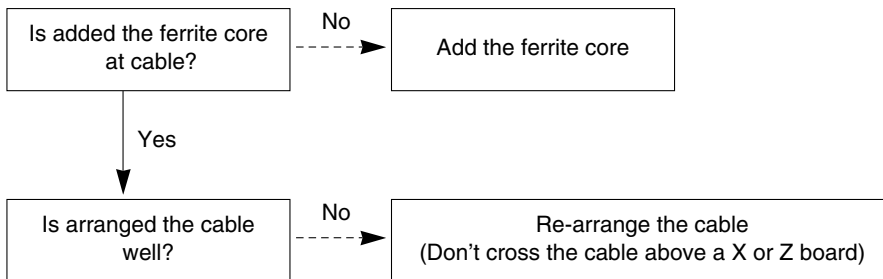

8. No Picture

(1) Symptom

- 1) Some mode doesn't display.
- 2) Front LED is green.
- 3) The set still discharge a little.



(2) Check following

1) RF-mode doesn't display

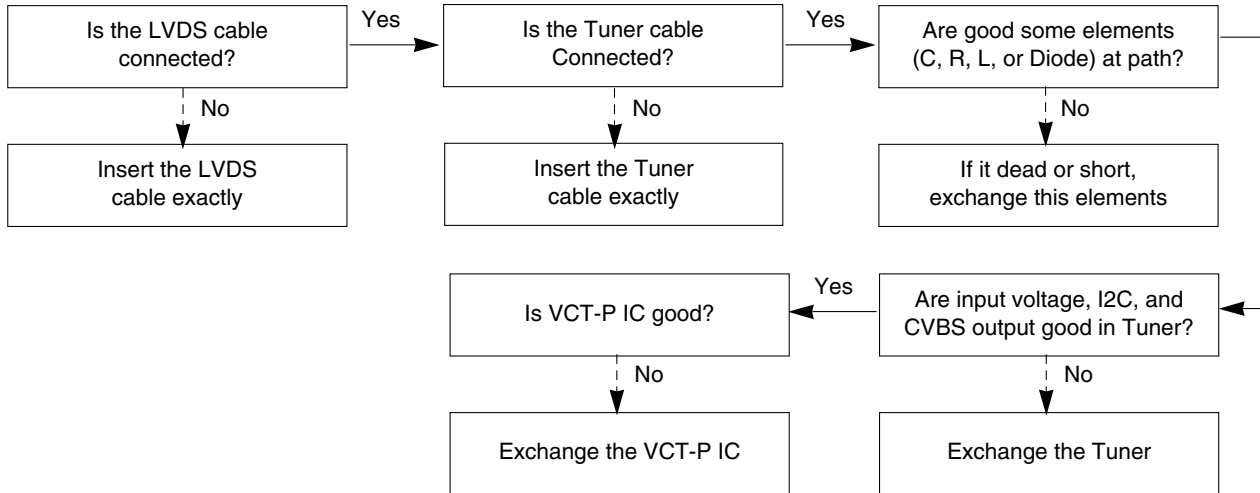

2) AV/Component-mode doesn't display.

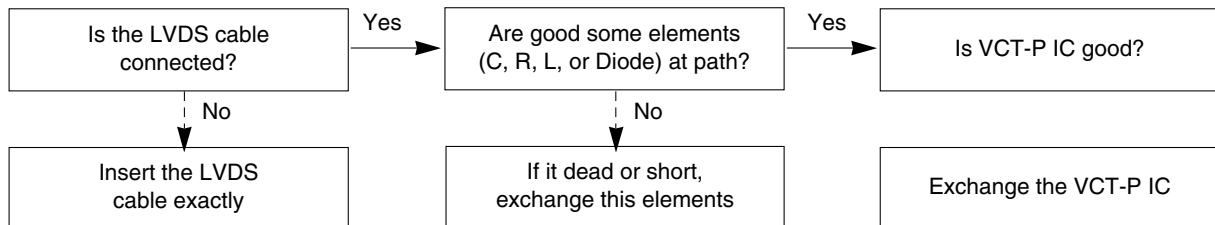

3) RGB/HDMI-mode doesn't display.

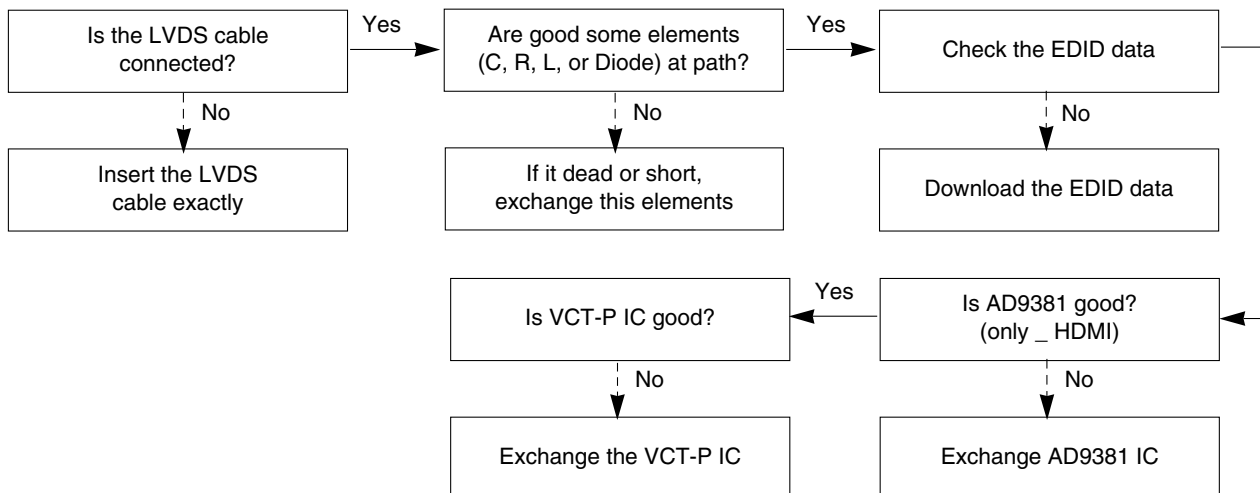

PRINTED CIRCUIT BOARD

MAIN(TOP)

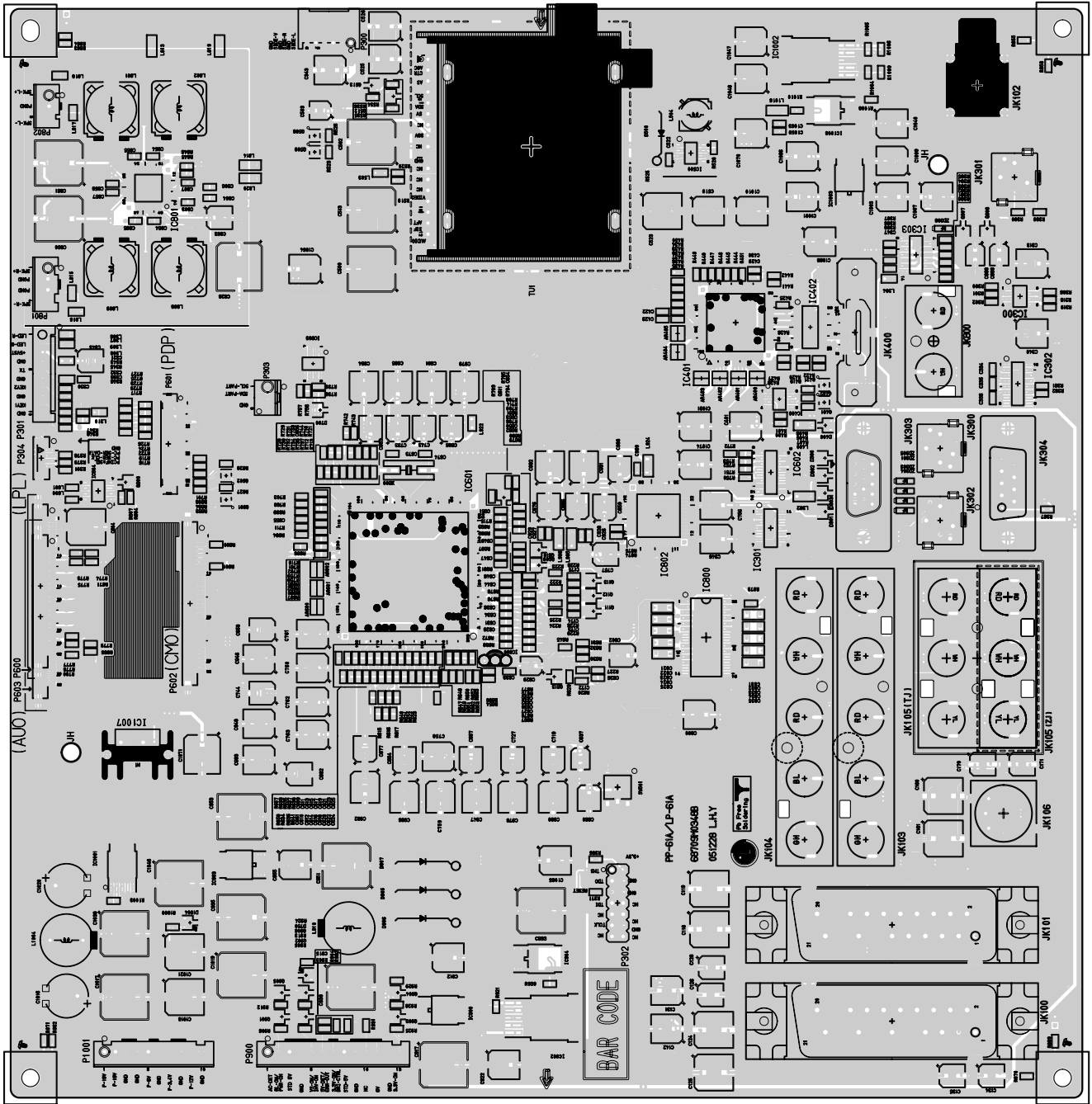

CONTROL

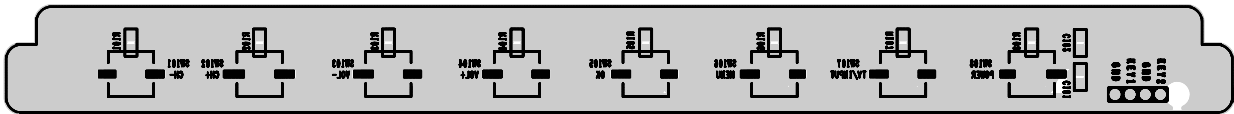

MAIN(BOTTOM)

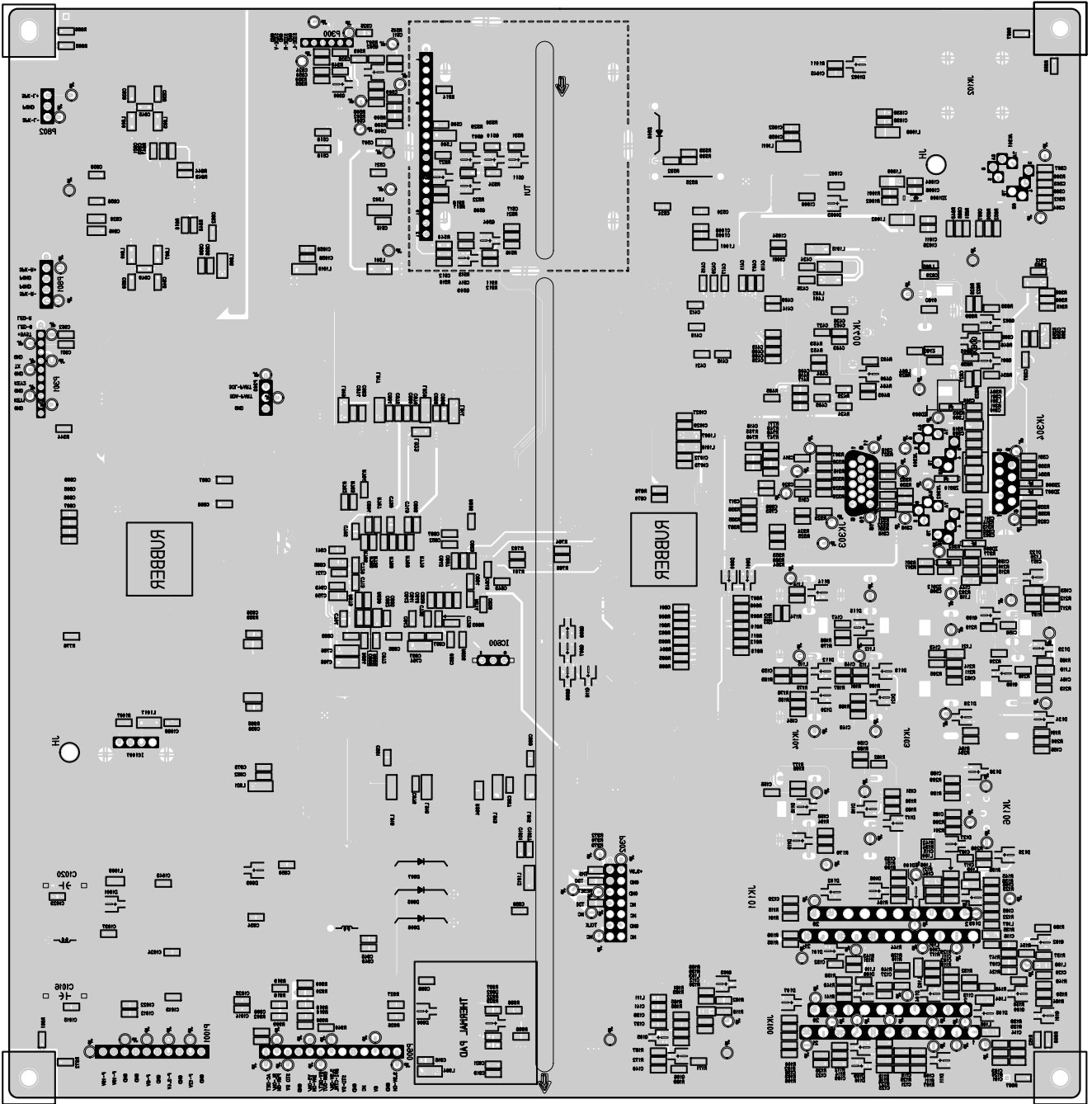

PRE-AMP

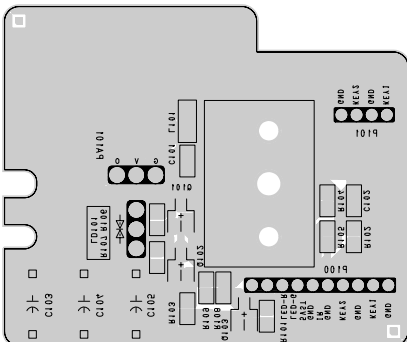

SIDE A/V

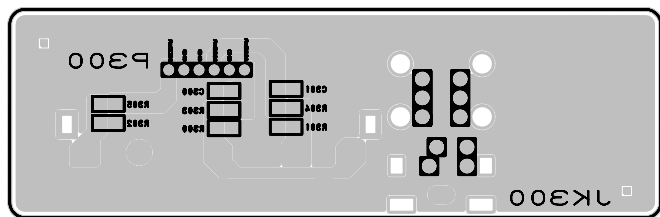

BLOCK DIAGRAM

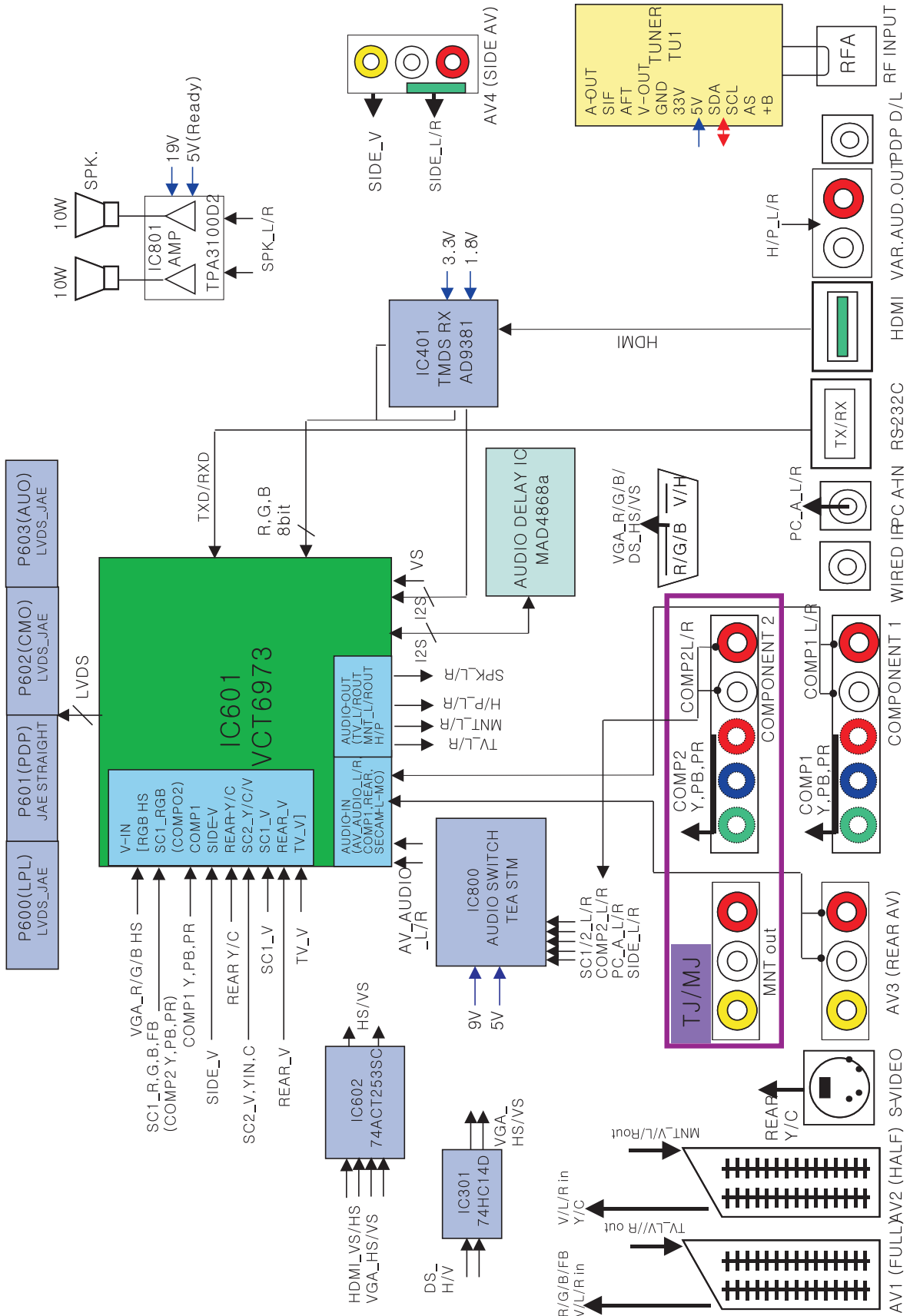

EXPLODED VIEW

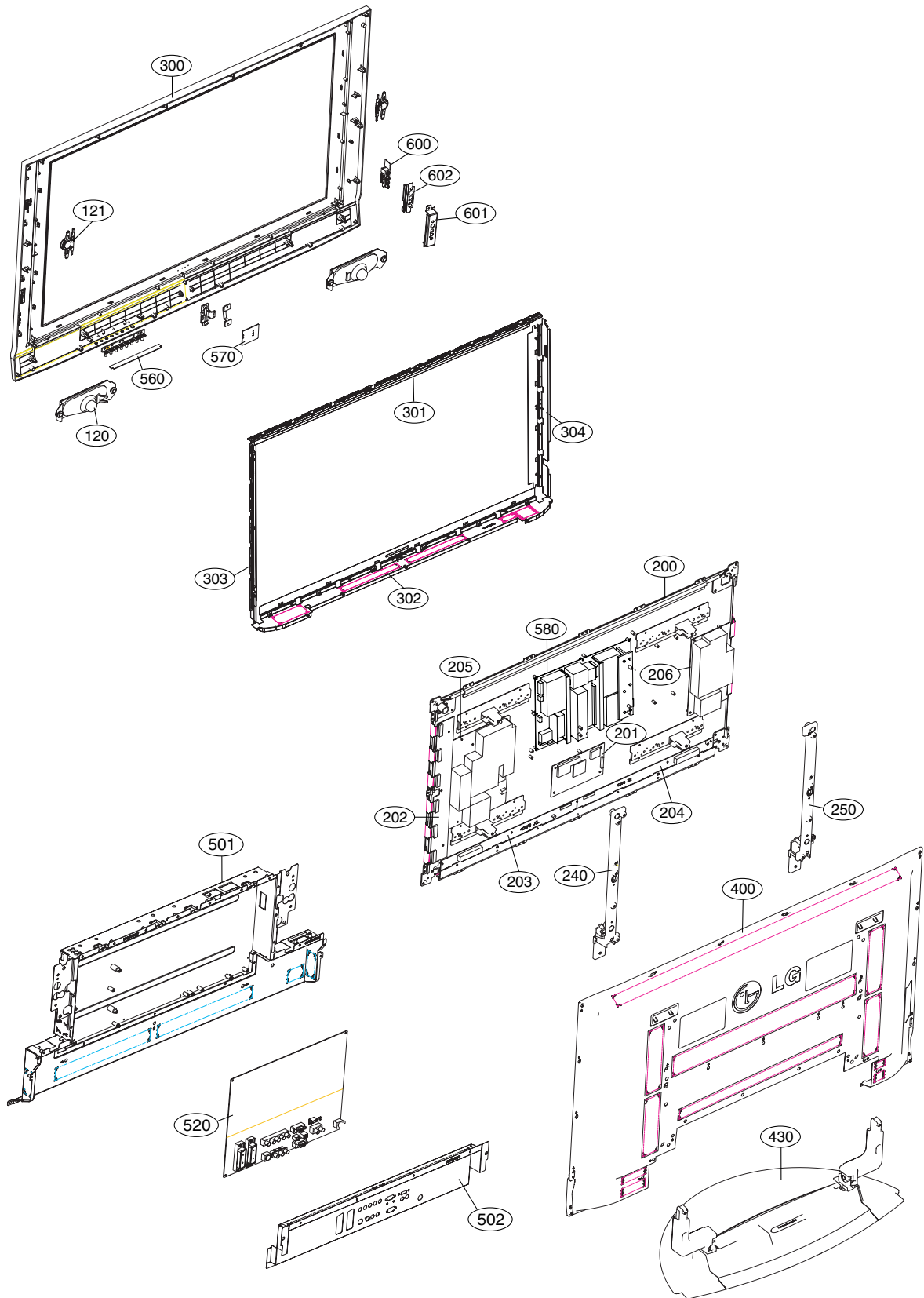

EXPLODED VIEW PARTS LIST

The components identified by mark  is critical for safety.
Replace only with part number specified.

No.	Part No.	Descriptions
120	6400WMCX03A	SPEAKER, WOOFER G1560102 MACOM WOOFER 8OHM 15/20W 82DB OTHERS 100HZ 193*57MM
121	6400DTTX02B	SPEAKER, TWEETER EN15D-6659 TOPTONE TWEETER(DOME) 8OHM 15/20W 78DB OTHERS PC1 MODEL
	6348Q-E113H	PDP, 42" 852*480 PDP42V80201.AKLG 42PC1RV-ZJ CIS SET
	6348Q-E127T	PDP, 42 852*480 PDP42V80201.ADLGB
	6871QCH074A	PWB(PCB) ASSEMBLY, DISPLAY CTRL ASSY HAND INSERT 42 42V8 4005 ASIC LVDS
	6871QDH118A	PWB(PCB) ASSEMBLY, DISPLAY YDRV ASSY HAND INSERT 42 42V8 80PIN SCAN IC APLICATION
	6871QLH057A	PWB(PCB) ASSEMBLY, DISPLAY XRLT ASSY HAND INSERT 42 42V8 XL 4004 ASIC LVDS
	6871QRH067A	PWB(PCB) ASSEMBLY, DISPLAY XRRT ASSY HAND INSERT 42 42V8 XR 4004 ASIC LVDS
	6871QYH048A	PWB(PCB) ASSEMBLY, DISPLAY YSUS ASSY HAND INSERT 42 42V8 Y SUS B/D
	6871QZH053A	PWB(PCB) ASSEMBLY, DISPLAY ZSUS ASSY HAND INSERT 42 42V8
240	4980900109A	SUPPORTER, ASSY AL 42PC1R-TA, VERTICAL RIGHT 42PC1RV-ZJ CIS SET
	4980900109C	SUPPORTER, ASSY AL 42PC1R-TA, VERTICAL RIGHT, C/SKD
250	4980900109B	SUPPORTER, ASSY AL 42PC1R-TA, VERTICAL LEFT 42PC1RV-ZJ CIS SET
	4980900109D	SUPPORTER, ASSY AL 42PC1R-TA, VERTICAL LEFT, C/SKD
	30919E0006A	CABINET ASSEMBLY, 42PC1RV-ZJ BRAND 30909E0001A 42PC1RV-ZJ CIS SET
	30919E0006C	CABINET ASSEMBLY, 42PC1RV-TJ(CHINA) BRAND 30909E0001A-> 42PC1RVA-ZJ
	30919E0006H	CABINET ASSEMBLY, 42PC1RV-ZJ BRAND 30909E0001A C/SKD -> 42PC1RV-ZJ
301	4980900113A	SUPPORTER, ASSY AL FILTER TOP 42PC1R-TA 42PC1RV-ZJ CIS SET
	4980900113B	SUPPORTER, ASSY AL FILTER TOP 42PC1R-TA C/SKD
302	4980900114A	SUPPORTER, ASSY AL FILTER BOTTOM 42PC1R-TA 42PC1RV-ZJ CIS SET
	4980900114B	SUPPORTER, ASSY AL FILTER BOTTOM 42PC1R-TA C/SKD
303	4980900115A	SUPPORTER, ASSY AL FILTER RIGHT 42PC1R-TA 42PC1RV-ZJ CIS SET
	4980900115B	SUPPORTER, ASSY AL FILTER RIGHT 42PC1R-TA, C/SKD
304	4980900116A	SUPPORTER, ASSY AL FILTER LEFT 42PC1-TA 42PC1RV-ZJ CIS SET
	4980900116B	SUPPORTER, ASSY AL FILTER LEFT 42PC1-TA, C/SKD
	3809900103A	BACK COVER ASSEMBLY, 42PC1R ANALOG 42PC1RV-ZJ CIS SET
	3809900103P	BACK COVER ASSEMBLY, 42PC1 LGEMA ASSY ONLY (ANALOG)
	3501900014A	BOARD ASSEMBLY, D/T SPK STAND AP-42DC11 MF056A FOLDING STAND 42PC1RV-ZJ CIS SET
	3501900014C	BOARD ASSEMBLY, D/T SPK STAND AP-42DC11 MF056A FOLDING STAND LGERS C/SKD
501	3301900095D	PLATE ASSEMBLY, AV 3301900098A 3300900017D(PRESS) 42PC VCTP
	3301900095Q	PLATE ASSEMBLY, AV 3301900098A 3300900017H(PRESS) H3-M C/SKD
502	3301900094B	PLATE ASSEMBLY, ASSY 3300900010D VCTP PDP PC SERIES COMMON 42PC1RV-ZJ CIS SET
	3301900094G	PLATE ASSEMBLY, ASSY 3300900010G H3 PDP PC SERIES EU, C/SKD
520	68719MMV88A	PWB(PCB) ASSEMBLY, MAIN MAIN1 M.I PP61A 42PC1RV ZJ
	68719MMW87A	PWB(PCB) ASSEMBLY, MAIN MAIN1 M.I PP61A 42PC1RV ZJ CKD MANUAL INSERT FOR CKD (KETLLMP)
560	68719SMJ63A	PWB(PCB) ASSEMBLY, SUB SUB M.I PP61A 42PC3RV Z LOCAL CLTR
	68719SMM24A	PWB(PCB) ASSEMBLY,SUB SUB M.I PP61A 42PC1RV Z CKD LOCAL (KETLLMP)
570	68719SMJ64A	PWB(PCB) ASSEMBLY, SUB SUB M.I PP61A 42PC3RV Z PREAMP+LED
	68719SMM25A	PWB(PCB) ASSEMBLY,SUB SUB M.I PP61A 42PC1RV Z CKD PREAMP (KETLLMP)
	6709900019A	POWER SUPPLY ASSEMBLY 42INCH UNIFICATION PSU PDP LGIT PA61B 400W 42PB2D
600	68719SMJ74A	PWB(PCB) ASSEMBLY,SUB SUB M.I PP61A 42PC3RV ZJ SIDEAV
	68719SMM26A	PWB(PCB) ASSEMBLY,SUB, SUB M.I PP61A 42PC1RV Z CKD SIDE AV (KETLLMP)
601	4811900021C	BRACKET ASSEMBLY, SIDE AV 42PC1R-ZH PP62A CORTEZ-A, EU 42PC1RV-ZJ CIS SET
	4811900021G	BRACKET ASSEMBLY, SIDE AV 42PC1R-ZH PP62A SKD
602	48149V0003A	SHIELD, SIDE AV 42PC1R

REPLACEMENT PARTS LIST

LOCA. NO	PART NO	DESCRIPTION	LOCA. NO	PART NO	DESCRIPTION
IC					
IC1001	0IPMGKE030A	KIA78R05F KEC 5PIN DPAK R/TP 1A,5V LDO	Q512	0TR387500AA	CHIP 2SC3875S(ALY) BK KEC
IC1002	0IPMG00027A	SC156515M-1.8TR SEMTECH 5P/TO-263-5	Q513	0TR387500AA	CHIP 2SC3875S(ALY) BK KEC
IC1003	0IMCRFA010A	KA7809R, FAIRCHILD 2P D-PAK, R/TP	Q600	0TR387500AA	CHIP 2SC3875S(ALY) BK KEC
IC300	0ICS240213A	CAT24W(F)C02J-TE13 8P SOP TP 2K	Q605	0TR102009AM	KRA102S KEC REEL TAPING SOT23 -50V
IC301	0IPH741400E	74HC14D 14SOP TP SHITTER TRIGGER	Q606	0TR150400BA	CHIP 2SA1504S(ASY) BK KEC
IC302	0IPRP00009A	ICL3232CBNZ INTERSIL 16P/SOP	Q607	0TR387500AA	CHIP 2SC3875S(ALY) BK KEC
IC303	0ISTL00031A	MC74HC4066ADR2G,LF ON SEMI 14P	Q608	0TR150400BA	CHIP 2SA1504S(ASY) BK KEC
IC400	0IMMRAL014B	AT24C02N-10SI-2.7 ATMEL 8P SOIC	Q611	0TR387500AA	CHIP 2SC3875S(ALY) BK KEC
IC401	0IPRP00701A	AD9381KSTZ ANALOG DEVICE 100P,LQFP	Q613	0TR150400BA	CHIP 2SA1504S(ASY) BK KEC
IC500	0IPMGON013B	MC34063ADR2G ON SEMI SO-8P R/TP DC-DC	Q614	0TR150400BA	CHIP 2SA1504S(ASY) BK KEC
IC600	0IFA752700A	KA75270Z 3 TP RE-SET IC MC-007	Q615	0TR150400BA	CHIP 2SA1504S(ASY) BK KEC
IC601	0IPRP00689A	VCT6973G-FA-B2-000 MICRONAS 208P	Q617	0TR150400BA	CHIP 2SA1504S(ASY) BK KEC
IC602	0IFA742530B	74ACT253SC FAIRCHILD 16P SOIC R/TP	Q801	0TR387500AA	CHIP 2SC3875S(ALY) BK KEC
IC603	0IMMRAL025A	AT24C32AN-10SI-2.7 ATMEL 8PIN SOP	Q802	0TR387500AA	CHIP 2SC3875S(ALY) BK KEC
IC800	0IPRP00665A	TEA6420D STM 28PIN SO28 REEL TAPING	Q901	0TR387500AA	CHIP 2SC3875S(ALY) BK KEC
IC801	0IPRP00700A	TPA3100D2PHPR TEXAS INSTRUMENT 48P	Q902	0TR387500AA	CHIP 2SC3875S(ALY) BK KEC
IC802	0IPRP00743A	MAD4868A MICRONAS 44P,PMQFP TRAY	Q903	0TR387500AA	CHIP 2SC3875S(ALY) BK KEC
IC900	0IMCRRH001A	BA033FP-E2 ROHM 3P-SOP,TO252-3	Q904	0TR387500AA	CHIP 2SC3875S(ALY) BK KEC
IC902	0IPMG00027A	SC156515M-1.8TR SEMTECH 5P/TO-263-5	Q905	0TR387500AA	CHIP 2SC3875S(ALY) BK KEC
IC903	0IMCRRH001A	BA033FP-E2 ROHM 3P-SOP,TO252-3	Q906	0TR387500AA	CHIP 2SC3875S(ALY) BK KEC
S1	692791152AA	SOFT WARE, 2.00V 8620 PDP PP61A 42PC3RV-ZJ	Q907	0TR387500AA	CHIP 2SC3875S(ALY) BK KEC
			Q908	0TR387500AA	CHIP 2SC3875S(ALY) BK KEC
TRANSISTOR			DIODE		
Q100	0TR387500AA	CHIP 2SC3875S(ALY) BK KEC	D1001	0DS226009AA	KDS226 TP KEC - 80V 4NSEC 0.5UA
Q101	0TR387500AA	CHIP 2SC3875S(ALY) BK KEC	D1002	0DS226009AA	KDS226 TP KEC - 80V 4NSEC 0.5UA
Q101	0TR387500AA	CHIP 2SC3875S(ALY) BK KEC	D1003	0DS226009AA	KDS226 TP KEC - 80V 4NSEC 0.5UA
Q102	0TR387500AA	CHIP 2SC3875S(ALY) BK KEC	D108	0DS226009AA	KDS226 TP KEC - 80V 4NSEC 0.5UA
Q102	0TR387500AA	CHIP 2SC3875S(ALY) BK KEC	D109	0DS226009AA	KDS226 TP KEC - 80V 4NSEC 0.5UA
Q102	0TR387500AA	CHIP 2SC3875S(ALY) BK KEC	D110	0DS226009AA	KDS226 TP KEC - 80V 4NSEC 0.5UA
Q103	0TR387500AA	CHIP 2SC3875S(ALY) BK KEC	D111	0DS226009AA	KDS226 TP KEC - 80V 4NSEC 0.5UA
Q105	0TR387500AA	CHIP 2SC3875S(ALY) BK KEC	D127	0DS226009AA	KDS226 TP KEC - 80V 4NSEC 0.5UA
Q106	0TR387500AA	CHIP 2SC3875S(ALY) BK KEC	D300	0DS226009AA	KDS226 TP KEC - 80V 4NSEC 0.5UA
Q108	0TR387500AA	CHIP 2SC3875S(ALY) BK KEC	D301	0DS226009AA	KDS226 TP KEC - 80V 4NSEC 0.5UA
Q109	0TR387500AA	CHIP 2SC3875S(ALY) BK KEC	D302	0DS226009AA	KDS226 TP KEC - 80V 4NSEC 0.5UA
Q110	0TR387500AA	CHIP 2SC3875S(ALY) BK KEC	D303	0DS226009AA	KDS226 TP KEC - 80V 4NSEC 0.5UA
Q111	0TR387500AA	CHIP 2SC3875S(ALY) BK KEC	D400	0DD184009AA	KDS184 TP KEC - 85V - 300MA
Q112	0TR387500AA	CHIP 2SC3875S(ALY) BK KEC	D500	0DS113379BA	1SS133 T-72 TP ROHM KOREA DO34 90V
Q113	0TR387500AA	CHIP 2SC3875S(ALY) BK KEC	D700	0DD184009AA	KDS184 TP KEC - 85V - 300MA
Q300	0TR387500AA	CHIP 2SC3875S(ALY) BK KEC	D800	0DD184009AA	KDS184 TP KEC - 85V - 300MA
Q400	0TR387500AA	CHIP 2SC3875S(ALY) BK KEC	D801	0DD184009AA	KDS184 TP KEC - 85V - 300MA
Q401	0TR830009BA	BSS83 TP PHILIPS N-CHANNEL S/W TR	D900	0DS226009AA	KDS226 TP KEC - 80V 4NSEC 0.5UA
Q402	0TR830009BA	BSS83 TP PHILIPS N-CHANNEL S/W TR	D902	0DS226009AA	KDS226 TP KEC - 80V 4NSEC 0.5UA
Q502	0TR387500AA	CHIP 2SC3875S(ALY) BK KEC	D903	0DS226009AA	KDS226 TP KEC - 80V 4NSEC 0.5UA
Q503	0TR150400BA	CHIP 2SA1504S(ASY) BK KEC	D905	0DD200009AF	RU2M V(1) TP SANKEN R-TMD 400V 1.1A
Q504	0TR387500AA	CHIP 2SC3875S(ALY) BK KEC	D906	0DD200009AF	RU2M V(1) TP SANKEN R-TMD 400V 1.1A
Q505	0TR150400BA	CHIP 2SA1504S(ASY) BK KEC	D907	0DD200009AF	RU2M V(1) TP SANKEN R-TMD 400V 1.1A
Q506	0TR150400BA	CHIP 2SA1504S(ASY) BK KEC	ZD1000	0DZKE00048A	KDZ8.2V USC KEC R/TP 200MW
Q507	0TR387500AA	CHIP 2SC3875S(ALY) BK KEC	ZD301	0DR050008AA	SD05.TC R/TP SEMTECH SOD323 5V 5A 15A
Q508	0TR830009BA	BSS83 TP PHILIPS N-CHANNEL S/W TR	ZD303	0DR050008AA	SD05.TC R/TP SEMTECH SOD323 5V 5A 15A
Q509	0TR830009BA	BSS83 TP PHILIPS N-CHANNEL S/W TR	ZD304	0DR050008AA	SD05.TC R/TP SEMTECH SOD323 5V 5A 15A
Q510	0TR150400BA	CHIP 2SA1504S(ASY) BK KEC	ZD305	0DR050008AA	SD05.TC R/TP SEMTECH SOD323 5V 5A 15A
Q511	0TR150400BA	CHIP 2SA1504S(ASY) BK KEC	ZD308	0DR050008AA	SD05.TC R/TP SEMTECH SOD323 5V 5A 15A

For Capacitor & Resistors, the characters at 2nd and 3rd digit in the P/No. means as follows;	CC, CX, CK, CN : Ceramic CQ : Polyester CE : Electrolytic	RD : Carbon Film RS : Metal Oxide Film RN : Metal Film RF : Fusible
--	---	--

LOCA. NO	PART NO	DESCRIPTION
CAPACITOR		
C1000	0CK104CK56A	0.1UF 1608 50V 10% R/TP X7R
C1001	0CE107WF6DC	100UF MVK 16V 20% R/TP(SMD) SMD
C1002	0CK104CK56A	0.1UF 1608 50V 10% R/TP X7R
C1003	0CE107WF6DC	100UF MVK 16V 20% R/TP(SMD) SMD
C1004	0CK104CK56A	0.1UF 1608 50V 10% R/TP X7R
C1005	0CK104CK56A	0.1UF 1608 50V 10% R/TP X7R
C1006	0CK103CK56A	0.01UF 1608 50V 10% R/TP X7R
C1007	0CE107WF6DC	100UF MVK 16V 20% R/TP(SMD) SMD
C1008	0CK103CK56A	0.01UF 1608 50V 10% R/TP X7R
C1009	0CE107WF6DC	100UF MVK 16V 20% R/TP(SMD) SMD
C1010	0CE107WF6DC	100UF MVK 16V 20% R/TP(SMD) SMD
C1011	0CK103CK56A	0.01UF 1608 50V 10% R/TP X7R
C1012	0CK104CK56A	0.1UF 1608 50V 10% R/TP X7R
C1013	0CK104CK56A	0.1UF 1608 50V 10% R/TP X7R
C1014	0CK104CK56A	0.1UF 1608 50V 10% R/TP X7R
C1015	0CK104CK56A	0.1UF 1608 50V 10% R/TP X7R
C1016	0CE477EJ618	470UF KMG 35V 20% FL TP 5
C1017	0CE477WF6DC	470UF MVK 16V 20% SMD R/TP(SMD)
C1018	0CE227WF6DC	220UF MVK 16V 20% R/TP(SMD) SMD
C1019	0CE477WF6DC	470UF MVK 16V 20% SMD R/TP(SMD)
C1020	0CE477EJ618	470UF KMG 35V 20% FL TP 5
C1021	0CE227WF6DC	220UF MVK 16V 20% R/TP(SMD) SMD
C1022	0CK104CK56A	0.1UF 1608 50V 10% R/TP X7R
C1023	0CK104CK56A	0.1UF 1608 50V 10% R/TP X7R
C1024	0CK104CK56A	0.1UF 1608 50V 10% R/TP X7R
C1025	0CK104CK56A	0.1UF 1608 50V 10% R/TP X7R
C1026	0CK103CK56A	0.01UF 1608 50V 10% R/TP X7R
C1027	0CK104CK56A	0.1UF 1608 50V 10% R/TP X7R
C1029	0CK103CK56A	0.01UF 1608 50V 10% R/TP X7R
C103	0CE4763F618	47UF SRE,SE 16V 20% FL TP 5
C1031	0CE107WF6DC	100UF MVK 16V 20% R/TP(SMD) SMD
C1036	0CK104CK56A	0.1UF 1608 50V 10% R/TP X7R
C1037	0CK104CK56A	0.1UF 1608 50V 10% R/TP X7R
C1038	0CE477WF6DC	470UF MVK 16V 20% SMD R/TP(SMD)
C1039	0CK103CK56A	0.01UF 1608 50V 10% R/TP X7R
C104	0CE4763F618	47UF SRE,SE 16V 20% FL TP 5
C1040	0CE476WF6DC	47UF MVK 16V 20% R/TP(SMD) SMD
C1043	0CK104CK56A	0.1UF 1608 50V 10% R/TP X7R
C1045	0CK104CK56A	0.1UF 1608 50V 10% R/TP X7R
C1046	0CE477WF6DC	470UF MVK 16V 20% SMD R/TP(SMD)
C1047	0CE107WF6DC	100UF MVK 16V 20% R/TP(SMD) SMD
C1048	0CE107WF6DC	100UF MVK 16V 20% R/TP(SMD) SMD
C105	0CE4763F618	47UF SRE,SE 16V 20% FL TP 5
C1050	0CK104CK56A	0.1UF 1608 50V 10% R/TP X7R
C1051	0CK104CK56A	0.1UF 1608 50V 10% R/TP X7R
C1052	0CK104CK56A	0.1UF 1608 50V 10% R/TP X7R
C1054	0CK104CK56A	0.1UF 1608 50V 10% R/TP X7R
C1056	0CK103CK56A	0.01UF 1608 50V 10% R/TP X7R
C1057	0CK103CK56A	0.01UF 1608 50V 10% R/TP X7R
C1058	0CK103CK56A	0.01UF 1608 50V 10% R/TP X7R

LOCA. NO	PART NO	DESCRIPTION
C1059	0CK104CK56A	0.1UF 1608 50V 10% R/TP X7R
C1061	0CK103CK56A	0.01UF 1608 50V 10% R/TP X7R
C1063	0CK103CK56A	0.01UF 1608 50V 10% R/TP X7R
C1064	0CE107WF6DC	100UF MVK 16V 20% R/TP(SMD) SMD
C1065	0CE107WF6DC	100UF MVK 16V 20% R/TP(SMD) SMD
C1066	0CE107WF6DC	100UF MVK 16V 20% R/TP(SMD) SMD
C1068	0CE107WF6DC	100UF MVK 16V 20% R/TP(SMD) SMD
C1069	0CK104CK56A	0.1UF 1608 50V 10% R/TP X7R
C1070	0CE476WF6DC	47UF MVK 16V 20% R/TP(SMD) SMD
C1071	0CE227WF6DC	220UF MVK 16V 20% R/TP(SMD) SMD
C1072	0CK104CK56A	0.1UF 1608 50V 10% R/TP X7R
C1073	0CK103CK56A	0.01UF 1608 50V 10% R/TP X7R
C1074	0CE107WF6DC	100UF MVK 16V 20% R/TP(SMD) SMD
C111	0CK103CK56A	0.01UF 1608 50V 10% R/TP X7R
C112	0CC102CK41A	1000PF 1608 50V 5% R/TP NP0
C113	0CK103CK56A	0.01UF 1608 50V 10% R/TP X7R
C114	0CC102CK41A	1000PF 1608 50V 5% R/TP NP0
C115	0CK103CK56A	0.01UF 1608 50V 10% R/TP X7R
C116	0CC102CK41A	1000PF 1608 50V 5% R/TP NP0
C117	0CK103CK56A	0.01UF 1608 50V 10% R/TP X7R
C118	0CE227WF6DC	220UF MVK 16V 20% R/TP(SMD) SMD
C119	0CE227WF6DC	220UF MVK 16V 20% R/TP(SMD) SMD
C120	0CC102CK41A	1000PF 1608 50V 5% R/TP NP0
C124	0CE227WF6DC	220UF MVK 16V 20% R/TP(SMD) SMD
C125	0CE227WF6DC	220UF MVK 16V 20% R/TP(SMD) SMD
C126	0CE106WH6DC	10UF MVK 25V 20% R/TP(SMD) SMD
C128	0CE106WH6DC	10UF MVK 25V 20% R/TP(SMD) SMD
C131	0CE476WF6DC	47UF MVK 16V 20% R/TP(SMD) SMD
C134	0CE106WH6DC	10UF MVK 25V 20% R/TP(SMD) SMD
C135	0CE106WH6DC	10UF MVK 25V 20% R/TP(SMD) SMD
C137	0CK104CK56A	0.1UF 1608 50V 10% R/TP X7R
C138	0CK104CK56A	0.1UF 1608 50V 10% R/TP X7R
C141	0CK104CK56A	0.1UF 1608 50V 10% R/TP X7R
C142	0CE476WF6DC	47UF MVK 16V 20% R/TP(SMD) SMD
C159	0CC102CK41A	1000PF 1608 50V 5% R/TP NP0
C162	0CC102CK41A	1000PF 1608 50V 5% R/TP NP0
C163	0CK103CK56A	0.01UF 1608 50V 10% R/TP X7R
C164	0CK103CK56A	0.01UF 1608 50V 10% R/TP X7R
C172	0CK682CK51A	6800PF 1608 50V 10% R/TP B(Y5P)
C173	0CK682CK51A	6800PF 1608 50V 10% R/TP B(Y5P)
C174	0CK682CK51A	6800PF 1608 50V 10% R/TP B(Y5P)
C175	0CK682CK51A	6800PF 1608 50V 10% R/TP B(Y5P)
C309	0CK103CK56A	0.01UF 1608 50V 10% R/TP X7R
C310	0CK103CK56A	0.01UF 1608 50V 10% R/TP X7R
C311	0CC470CK41A	47PF 1608 50V 5% R/TP NP0
C312	0CK104CK56A	0.1UF 1608 50V 10% R/TP X7R
C313	0CE476WF6DC	47UF MVK 16V 20% R/TP(SMD) SMD
C316	0CC120CK41A	12PF 1608 50V 5% R/TP NP0
C317	0CC120CK41A	12PF 1608 50V 5% R/TP NP0
C332	0CK104CK56A	0.1UF 1608 50V 10% R/TP X7R
C333	0CK104CK56A	0.1UF 1608 50V 10% R/TP X7R
C334	0CK104CK56A	0.1UF 1608 50V 10% R/TP X7R

For Capacitor & Resistors, the characters at 2nd and 3rd digit in the P/No. means as follows;

CC, CX, CK, CN : Ceramic	RD : Carbon Film
CQ : Polyester	RS : Metal Oxide Film
CE : Electrolytic	RN : Metal Film
	RF : Fusible

LOCA. NO	PART NO	DESCRIPTION
C335	0CK104CK56A	0.1UF 1608 50V 10% R/TP X7R
C336	0CK104CK56A	0.1UF 1608 50V 10% R/TP X7R
C337	0CK104CK56A	0.1UF 1608 50V 10% R/TP X7R
C338	0CK104CK56A	0.1UF 1608 50V 10% R/TP X7R
C339	0CK104CK56A	0.1UF 1608 50V 10% R/TP X7R
C340	0CE107WF6DC	100UF MVK 16V 20% R/TP(SMD) SMD
C343	0CE476WF6DC	47UF MVK 16V 20% R/TP(SMD) SMD
C345	0CE226WF6DC	22UF MVK 16V 20% R/TP(SMD) SMD
C346	0CE476WF6DC	47UF MVK 16V 20% R/TP(SMD) SMD
C347	0CK104CF56A	0.1UF 1608 16V 10% R/TP X7R
C350	0CK103CK56A	0.01UF 1608 50V 10% R/TP X7R
C351	0CK104CK56A	0.1UF 1608 50V 10% R/TP X7R
C352	0CK104CK56A	0.1UF 1608 50V 10% R/TP X7R
C400	0CK104CK56A	0.1UF 1608 50V 10% R/TP X7R
C401	0CE476WF6DC	47UF MVK 16V 20% R/TP(SMD) SMD
C406	0CK104CK56A	0.1UF 1608 50V 10% R/TP X7R
C407	0CK104CK56A	0.1UF 1608 50V 10% R/TP X7R
C408	0CK104CK56A	0.1UF 1608 50V 10% R/TP X7R
C409	0CK104CK56A	0.1UF 1608 50V 10% R/TP X7R
C410	0CK102CK56A	1000PF 1608 50V 0.1 R/TP X7R
C411	0CK102CK56A	1000PF 1608 50V 0.1 R/TP X7R
C412	0CK104CK56A	0.1UF 1608 50V 10% R/TP X7R
C413	0CK104CK56A	0.1UF 1608 50V 10% R/TP X7R
C414	0CK104CK56A	0.1UF 1608 50V 10% R/TP X7R
C415	0CK104CK56A	0.1UF 1608 50V 10% R/TP X7R
C416	0CK104CK56A	0.1UF 1608 50V 10% R/TP X7R
C417	0CK102CK56A	1000PF 1608 50V 0.1 R/TP X7R
C419	0CK104CK56A	0.1UF 1608 50V 10% R/TP X7R
C420	0CK102CK56A	1000PF 1608 50V 0.1 R/TP X7R
C421	0CK104CK56A	0.1UF 1608 50V 10% R/TP X7R
C424	0CK104CK56A	0.1UF 1608 50V 10% R/TP X7R
C425	0CK104CK56A	0.1UF 1608 50V 10% R/TP X7R
C426	0CK104CK56A	0.1UF 1608 50V 10% R/TP X7R
C429	0CK822CK46A	8.2NF 1608 50V 5% X7R R/TP
C430	0CK823CF56A	82NF 1608 16V 10% X7R R/TP
C500	0CE477WF6DC	470UF MVK 16V 20% SMD R/TP(SMD)
C502	0CE477WF6DC	470UF MVK 16V 20% SMD R/TP(SMD)
C503	0CE475SK6DC	4.7UF MVG 50V 20% SMD R/TP
C506	0CK103CK56A	0.01UF 1608 50V 10% R/TP X7R
C507	0CK103CK56A	0.01UF 1608 50V 10% R/TP X7R
C508	0CC270CK41A	27PF 1608 50V 5% R/TP NP0
C509	0CC270CK41A	27PF 1608 50V 5% R/TP NP0
C511	0CK103CK56A	0.01UF 1608 50V 10% R/TP X7R
C512	0CC101CK41A	100PF 1608 50V 5% R/TP NP0
C513	0CE477WF6DC	470UF MVK 16V 20% SMD R/TP(SMD)
C514	0CK273CK56A	27000PF 1608 50V 10% X7R R/TP
C515	0CK103CK56A	0.01UF 1608 50V 10% R/TP X7R
C516	0CK104CK56A	0.1UF 1608 50V 10% R/TP X7R
C517	0CK103CK56A	0.01UF 1608 50V 10% R/TP X7R
C517	0CK273CK56A	27000PF 1608 50V 10% X7R R/TP
C518	0CK104CK56A	0.1UF 1608 50V 10% R/TP X7R
C519	0CE107WF6DC	100UF MVK 16V 20% R/TP(SMD) SMD

LOCA. NO	PART NO	DESCRIPTION
C520	0CK104CK56A	0.1UF 1608 50V 10% R/TP X7R
C521	0CC271CK41A	270PF 1608 50V 5% R/TP NP0
C522	0CC271CK41A	270PF 1608 50V 5% R/TP NP0
C523	0CE476WK6DC	47UF MVK 50V 20% R/TP(SMD) SMD
C524	0CK104CK56A	0.1UF 1608 50V 10% R/TP X7R
C525	0CE107WF6DC	100UF MVK 16V 20% R/TP(SMD) SMD
C605	0CK104CK56A	0.1UF 1608 50V 10% R/TP X7R
C606	0CK104CK56A	0.1UF 1608 50V 10% R/TP X7R
C607	0CK104CK56A	0.1UF 1608 50V 10% R/TP X7R
C608	0CK104CK56A	0.1UF 1608 50V 10% R/TP X7R
C609	0CK104CK56A	0.1UF 1608 50V 10% R/TP X7R
C610	0CK104CK56A	0.1UF 1608 50V 10% R/TP X7R
C611	0CK104CK56A	0.1UF 1608 50V 10% R/TP X7R
C612	0CK104CK56A	0.1UF 1608 50V 10% R/TP X7R
C613	0CK104CK56A	0.1UF 1608 50V 10% R/TP X7R
C614	0CK104CK56A	0.1UF 1608 50V 10% R/TP X7R
C615	0CK104CK56A	0.1UF 1608 50V 10% R/TP X7R
C616	0CK104CK56A	0.1UF 1608 50V 10% R/TP X7R
C617	0CK104CK56A	0.1UF 1608 50V 10% R/TP X7R
C618	0CK104CK56A	0.1UF 1608 50V 10% R/TP X7R
C619	0CK104CK56A	0.1UF 1608 50V 10% R/TP X7R
C620	0CK104CK56A	0.1UF 1608 50V 10% R/TP X7R
C621	0CK104CK56A	0.1UF 1608 50V 10% R/TP X7R
C622	0CK104CK56A	0.1UF 1608 50V 10% R/TP X7R
C623	0CK104CK56A	0.1UF 1608 50V 10% R/TP X7R
C624	0CK104CK56A	0.1UF 1608 50V 10% R/TP X7R
C625	0CK104CK56A	0.1UF 1608 50V 10% R/TP X7R
C626	0CK103CK56A	0.01UF 1608 50V 10% R/TP X7R
C627	0CK474CH94A	0.47UF 1608 25V 80%,-20% R/TP F(Y5V)
C628	0CK474CH94A	0.47UF 1608 25V 80%,-20% R/TP F(Y5V)
C629	0CE475WJ6DC	4.7UF MVK 35V 20% R/TP(SMD) SMD
C630	0CK474CH94A	0.47UF 1608 25V 80%,-20% R/TP F(Y5V)
C631	0CK474CH94A	0.47UF 1608 25V 80%,-20% R/TP F(Y5V)
C632	0CK474CH94A	0.47UF 1608 25V 80%,-20% R/TP F(Y5V)
C633	0CK103CK56A	0.01UF 1608 50V 10% R/TP X7R
C634	0CK474CH94A	0.47UF 1608 25V 80%,-20% R/TP F(Y5V)
C635	0CK474CH94A	0.47UF 1608 25V 80%,-20% R/TP F(Y5V)
C636	0CK474CH94A	0.47UF 1608 25V 80%,-20% R/TP F(Y5V)
C637	0CE335WK6D8	3.3UF MVK,RC 50V 20% SMD TAPPING
C638	0CK104CK56A	0.1UF 1608 50V 10% R/TP X7R
C643	0CK332CK56A	3.3NF 1608 50V 10% R/TP X7R
C645	0CK332CK56A	3.3NF 1608 50V 10% R/TP X7R
C647	0CK332CK56A	3.3NF 1608 50V 10% R/TP X7R
C648	0CK332CK56A	3.3NF 1608 50V 10% R/TP X7R
C649	0CK104CK56A	0.1UF 1608 50V 10% R/TP X7R
C650	0CK682CK51A	6800PF 1608 50V 10% R/TP B(Y5P)
C651	0CC560CK41A	56PF 1608 50V 5% R/TP NP0
C652	0CC560CK41A	56PF 1608 50V 5% R/TP NP0
C653	0CK682CK51A	6800PF 1608 50V 10% R/TP B(Y5P)
C654	0CK103CK56A	0.01UF 1608 50V 10% R/TP X7R
C655	0CC220CK41A	22PF 1608 50V 5% R/TP NP0
C657	0CE226WF6DC	22UF MVK 16V 20% R/TP(SMD) SMD

For Capacitor & Resistors, the characters at 2nd and 3rd digit in the P/No. means as follows;	CC, CX, CK, CN : Ceramic CQ : Polyester CE : Electrolytic	RD : Carbon Film RS : Metal Oxide Film RN : Metal Film RF : Fusible
--	---	--

LOCA. NO	PART NO	DESCRIPTION
C658	0CE226WF6DC	22UF MVK 16V 20% R/TP(SMD) SMD
C659	0CE226WF6DC	22UF MVK 16V 20% R/TP(SMD) SMD
C660	0CE226WF6DC	22UF MVK 16V 20% R/TP(SMD) SMD
C661	0CK104CK56A	0.1UF 1608 50V 10% R/TP X7R
C662	0CK225DK94A	2.2UF 2012 50V 80%,-20% F(Y5V) R/TP
C663	0CK104CK56A	0.1UF 1608 50V 10% R/TP X7R
C664	0CK104CK56A	0.1UF 1608 50V 10% R/TP X7R
C665	0CK225DK94A	2.2UF 2012 50V 80%,-20% F(Y5V) R/TP
C666	0CK225DD66A	2.2UF 2012 10V 20% X7R R/TP
C673	0CC220CK41A	22PF 1608 50V 5% R/TP NP0
C674	0CC220CK41A	22PF 1608 50V 5% R/TP NP0
C676	0CE226WF6DC	22UF MVK 16V 20% R/TP(SMD) SMD
C677	0CE226WF6DC	22UF MVK 16V 20% R/TP(SMD) SMD
C682	0CE226WF6DC	22UF MVK 16V 20% R/TP(SMD) SMD
C683	0CE226WF6DC	22UF MVK 16V 20% R/TP(SMD) SMD
C684	0CE226WF6DC	22UF MVK 16V 20% R/TP(SMD) SMD
C685	0CE226WF6DC	22UF MVK 16V 20% R/TP(SMD) SMD
C686	0CE226WF6DC	22UF MVK 16V 20% R/TP(SMD) SMD
C687	0CK104CK56A	0.1UF 1608 50V 10% R/TP X7R
C688	0CK104CK56A	0.1UF 1608 50V 10% R/TP X7R
C693	0CK104CK56A	0.1UF 1608 50V 10% R/TP X7R
C694	0CK104CK56A	0.1UF 1608 50V 10% R/TP X7R
C695	0CK104CK56A	0.1UF 1608 50V 10% R/TP X7R
C696	0CK104CK56A	0.1UF 1608 50V 10% R/TP X7R
C697	0CK104CK56A	0.1UF 1608 50V 10% R/TP X7R
C704	0CK104CK56A	0.1UF 1608 50V 10% R/TP X7R
C705	0CK104CK56A	0.1UF 1608 50V 10% R/TP X7R
C713	0CK104CK56A	0.1UF 1608 50V 10% R/TP X7R
C719	0CE226WF6DC	22UF MVK 16V 20% R/TP(SMD) SMD
C721	0CK104CK56A	0.1UF 1608 50V 10% R/TP X7R
C726	0CK104CK56A	0.1UF 1608 50V 10% R/TP X7R
C727	0CE226WF6DC	22UF MVK 16V 20% R/TP(SMD) SMD
C729	0CK104CK56A	0.1UF 1608 50V 10% R/TP X7R
C733	0CE226WF6DC	22UF MVK 16V 20% R/TP(SMD) SMD
C735	0CK104CK56A	0.1UF 1608 50V 10% R/TP X7R
C739	0CK104CK56A	0.1UF 1608 50V 10% R/TP X7R
C743	0CE226WF6DC	22UF MVK 16V 20% R/TP(SMD) SMD
C744	0CE226WF6DC	22UF MVK 16V 20% R/TP(SMD) SMD
C749	0CK104CK56A	0.1UF 1608 50V 10% R/TP X7R
C750	0CK225DK94A	2.2UF 2012 50V 80%,-20% F(Y5V) R/TP
C753	0CK104CK56A	0.1UF 1608 50V 10% R/TP X7R
C756	0CE476WF6DC	47UF MVK 16V 20% R/TP(SMD) SMD
C757	0CE106WH6DC	10UF MVK 25V 20% R/TP(SMD) SMD
C758	0CE476WF6DC	47UF MVK 16V 20% R/TP(SMD) SMD
C759	0CE476WF6DC	47UF MVK 16V 20% R/TP(SMD) SMD
C760	0CE476WF6DC	47UF MVK 16V 20% R/TP(SMD) SMD
C761	0CE476WF6DC	47UF MVK 16V 20% R/TP(SMD) SMD
C762	0CE476WF6DC	47UF MVK 16V 20% R/TP(SMD) SMD
C763	0CE476WF6DC	47UF MVK 16V 20% R/TP(SMD) SMD
C764	0CK103CK56A	0.01UF 1608 50V 10% R/TP X7R
C764	0CK106EF56A	10UF 3216 16V 10% X7R R/TP
C765	0CK106EF56A	10UF 3216 16V 10% X7R R/TP

LOCA. NO	PART NO	DESCRIPTION
C766	0CK106EF56A	10UF 3216 16V 10% X7R R/TP
C800	0CE107WF6DC	100UF MVK 16V 20% R/TP(SMD) SMD
C801	0CK103CK56A	0.01UF 1608 50V 10% R/TP X7R
C802	0CE226WF6DC	22UF MVK 16V 20% R/TP(SMD) SMD
C803	0CK105CF94A	1UF 1608 16V 80%,-20% R/TP F(Y5V)
C804	0CK105CF94A	1UF 1608 16V 80%,-20% R/TP F(Y5V)
C806	0CK105CF94A	1UF 1608 16V 80%,-20% R/TP F(Y5V)
C807	0CK105CF94A	1UF 1608 16V 80%,-20% R/TP F(Y5V)
C816	0CK225DK94A	2.2UF 2012 50V 80%,-20% F(Y5V) R/TP
C820	0CK225DK94A	2.2UF 2012 50V 80%,-20% F(Y5V) R/TP
C821	0CK475EF67A	4.7UF 3216 16V 20% X5R R/TP
C822	0CK475EF67A	4.7UF 3216 16V 20% X5R R/TP
C823	0CK475EF67A	4.7UF 3216 16V 20% X5R R/TP
C824	0CK475EF67A	4.7UF 3216 16V 20% X5R R/TP
C825	0CK475EF67A	4.7UF 3216 16V 20% X5R R/TP
C827	0CC471CK41A	470PF 1608 50V 5% R/TP NP0
C828	0CE107WK6DC	100UF MVK 50V 20% R/TP(SMD) SMD
C829	0CC471CK41A	470PF 1608 50V 5% R/TP NP0
C830	0CK103CK56A	0.01UF 1608 50V 10% R/TP X7R
C831	0CK475EF67A	4.7UF 3216 16V 20% X5R R/TP
C832	0CK475EF67A	4.7UF 3216 16V 20% X5R R/TP
C833	0CK475EF67A	4.7UF 3216 16V 20% X5R R/TP
C834	0CK475EF67A	4.7UF 3216 16V 20% X5R R/TP
C835	0CK475EF67A	4.7UF 3216 16V 20% X5R R/TP
C836	0CK104CK56A	0.1UF 1608 50V 10% R/TP X7R
C838	0CK104CK56A	0.1UF 1608 50V 10% R/TP X7R
C839	0CK104CK56A	0.1UF 1608 50V 10% R/TP X7R
C840	0CK102CK56A	1000PF 1608 50V 0.1 R/TP X7R
C842	0CK102CK56A	1000PF 1608 50V 0.1 R/TP X7R
C845	0CK474CH94A	0.47UF 1608 25V 80%,-20% R/TP F(Y5V)
C848	0CK104CK56A	0.1UF 1608 50V 10% R/TP X7R
C849	0CK474CH94A	0.47UF 1608 25V 80%,-20% R/TP F(Y5V)
C850	0CK104CK56A	0.1UF 1608 50V 10% R/TP X7R
C851	0CK105CF94A	1UF 1608 16V 80%,-20% R/TP F(Y5V)
C853	0CK103CK56A	0.01UF 1608 50V 10% R/TP X7R
C854	0CK224CF56A	0.22UF 1608 16V 10% R/TP X7R
C855	0CK224CF56A	0.22UF 1608 16V 10% R/TP X7R
C856	0CK105CF94A	1UF 1608 16V 80%,-20% R/TP F(Y5V)
C857	0CK105CF94A	1UF 1608 16V 80%,-20% R/TP F(Y5V)
C858	0CK105CF94A	1UF 1608 16V 80%,-20% R/TP F(Y5V)
C859	0CK105CF94A	1UF 1608 16V 80%,-20% R/TP F(Y5V)
C860	0CE227WJ6DC	220UF MVK/RC 35V 20% SMD TAPPING
C861	0CE227WJ6DC	220UF MVK/RC 35V 20% SMD TAPPING
C862	0CK105CF94A	1UF 1608 16V 80%,-20% R/TP F(Y5V)
C863	0CE106WH6DC	10UF MVK 25V 20% R/TP(SMD) SMD
C864	0CK224CF56A	0.22UF 1608 16V 10% R/TP X7R
C865	0CK224CF56A	0.22UF 1608 16V 10% R/TP X7R
C866	0CK682CK51A	6800PF 1608 50V 10% R/TP B(Y5P)
C867	0CK682CK51A	6800PF 1608 50V 10% R/TP B(Y5P)
C868	0CE475WJ6DC	4.7UF MVK 35V 20% R/TP(SMD) SMD
C869	0CE475WJ6DC	4.7UF MVK 35V 20% R/TP(SMD) SMD
C906	0CK104CK56A	0.1UF 1608 50V 10% R/TP X7R

For Capacitor & Resistors, the characters at 2nd and 3rd digit in the P/No. means as follows;

CC, CX, CK, CN : Ceramic	RD : Carbon Film
CQ : Polyester	RS : Metal Oxide Film
CE : Electrolytic	RN : Metal Film
	RF : Fusible

LOCA. NO	PART NO	DESCRIPTION
C908	0CK474CH94A	0.47UF 1608 25V 80%,-20% R/TP F(Y5V)
C912	0CE476WF6DC	47UF MVK 16V 20% R/TP(SMD) SMD
C915	0CK474CH94A	0.47UF 1608 25V 80%,-20% R/TP F(Y5V)
C916	0CK104CK56A	0.1UF 1608 50V 10% R/TP X7R
C917	0CE477WF6DC	470UF MVK 16V 20% SMD R/TP(SMD)
C919	0CK104CK56A	0.1UF 1608 50V 10% R/TP X7R
C921	0CK103CK56A	0.01UF 1608 50V 10% R/TP X7R
C922	0CE476WF6DC	47UF MVK 16V 20% R/TP(SMD) SMD
C926	0CK104CK56A	0.1UF 1608 50V 10% R/TP X7R
C927	0CK104CK56A	0.1UF 1608 50V 10% R/TP X7R
C928	0CK103CK56A	0.01UF 1608 50V 10% R/TP X7R
C929	0CK103CK56A	0.01UF 1608 50V 10% R/TP X7R
C930	0CK104CK56A	0.1UF 1608 50V 10% R/TP X7R
C931	0CE476WF6DC	47UF MVK 16V 20% R/TP(SMD) SMD
C932	0CE476WF6DC	47UF MVK 16V 20% R/TP(SMD) SMD
C933	0CE477WF6DC	470UF MVK 16V 20% SMD R/TP(SMD)
C934	0CK104CK56A	0.1UF 1608 50V 10% R/TP X7R
C935	0CE477WF6DC	470UF MVK 16V 20% SMD R/TP(SMD)
C936	0CK104CK56A	0.1UF 1608 50V 10% R/TP X7R
C937	0CK104CK56A	0.1UF 1608 50V 10% R/TP X7R
C938	0CK104CK56A	0.1UF 1608 50V 10% R/TP X7R
C939	0CE477WF6DC	470UF MVK 16V 20% SMD R/TP(SMD)
C941	0CK103CK56A	0.01UF 1608 50V 10% R/TP X7R
C942	0CK103CK56A	0.01UF 1608 50V 10% R/TP X7R
C943	0CK103CK56A	0.01UF 1608 50V 10% R/TP X7R
C945	0CK104CK56A	0.1UF 1608 50V 10% R/TP X7R
C946	0CE107WF6DC	100UF MVK 16V 20% R/TP(SMD) SMD
C946	0CE476WF6DC	47UF MVK 16V 20% R/TP(SMD) SMD
C947	0CE107WF6DC	100UF MVK 16V 20% R/TP(SMD) SMD
C947	0CE476WF6DC	47UF MVK 16V 20% R/TP(SMD) SMD
C948	0CE107WF6DC	100UF MVK 16V 20% R/TP(SMD) SMD
C948	0CE476WF6DC	47UF MVK 16V 20% R/TP(SMD) SMD
C949	0CK103CK56A	0.01UF 1608 50V 10% R/TP X7R
C950	0CK104CK56A	0.1UF 1608 50V 10% R/TP X7R
C951	0CE477WF6DC	470UF MVK 16V 20% SMD R/TP(SMD)
C953	0CE477WF6DC	470UF MVK 16V 20% SMD R/TP(SMD)
C955	0CE107WF6DC	100UF MVK 16V 20% R/TP(SMD) SMD
C957	0CK104CK56A	0.1UF 1608 50V 10% R/TP X7R
C958	0CK104CK56A	0.1UF 1608 50V 10% R/TP X7R
C959	0CK104CK56A	0.1UF 1608 50V 10% R/TP X7R
C960	0CK104CK56A	0.1UF 1608 50V 10% R/TP X7R
C961	0CK104CK56A	0.1UF 1608 50V 10% R/TP X7R
C962	0CK104CK56A	0.1UF 1608 50V 10% R/TP X7R
C963	0CK104CK56A	0.1UF 1608 50V 10% R/TP X7R
C964	0CK104CK56A	0.1UF 1608 50V 10% R/TP X7R
C965	0CK104CK56A	0.1UF 1608 50V 10% R/TP X7R
C967	0CK103CK56A	0.01UF 1608 50V 10% R/TP X7R
C968	0CK103CK56A	0.01UF 1608 50V 10% R/TP X7R
C969	0CK103CK56A	0.01UF 1608 50V 10% R/TP X7R
C970	0CK103CK56A	0.01UF 1608 50V 10% R/TP X7R
C972	0CK103CK56A	0.01UF 1608 50V 10% R/TP X7R
C973	0CK103CK56A	0.01UF 1608 50V 10% R/TP X7R

LOCA. NO	PART NO	DESCRIPTION
C974	0CK103CK56A	0.01UF 1608 50V 10% R/TP X7R
C975	0CK103CK56A	0.01UF 1608 50V 10% R/TP X7R
C976	0CK103CK56A	0.01UF 1608 50V 10% R/TP X7R
C978	0CE476WF6DC	47UF MVK 16V 20% R/TP(SMD) SMD
C979	0CE476WF6DC	47UF MVK 16V 20% R/TP(SMD) SMD
C980	0CE476WF6DC	47UF MVK 16V 20% R/TP(SMD) SMD
C981	0CE476WF6DC	47UF MVK 16V 20% R/TP(SMD) SMD
C982	0CE476WF6DC	47UF MVK 16V 20% R/TP(SMD) SMD
C983	0CE476WF6DC	47UF MVK 16V 20% R/TP(SMD) SMD
C984	0CE476WF6DC	47UF MVK 16V 20% R/TP(SMD) SMD
C985	0CE476WF6DC	47UF MVK 16V 20% R/TP(SMD) SMD
C986	0CE476WF6DC	47UF MVK 16V 20% R/TP(SMD) SMD
C988	0CE106WH6DC	10UF MVK 25V 20% R/TP(SMD) SMD
C989	0CK103CK56A	0.01UF 1608 50V 10% R/TP X7R
COIL		
L1004	6140VB0004B	26UH 1UEWPHY 22.5TURN YL-9N 0.4
L801	6140VR0008A	SLF12575T-330M4R7 33UH SMD COIL
L802	6140VR0008A	SLF12575T-330M4R7 33UH SMD COIL
L808	6140VR0008A	SLF12575T-330M4R7 33UH SMD COIL
L809	6140VR0008A	SLF12575T-330M4R7 33UH SMD COIL
L910	6140VB0004B	26UH 1UEWPHY 22.5TURN YL-9N 0.4
CONNECTOR		
C1	6631900012C	10P 2.5MM 200MM H-H UL1007AWG24
C2	6631900027E	13P 2.5MM 300MM H-H UL1007AWG24
C3	6631900048C	4P 2.0MM 250MM H-H UL1061AWG26
C4	6631900050C	10P 2.0MM 1200MM H-H UL1185AWG26
C5	6631900097G	3P 2.5MM 950/700MM H-T UL1007AWG24
C6	6631900098G	4P 2.5MM 1050/700MM H-T UL1007AWG24
C7	6631900107A	4P 1.25MM 400MM H-H UL1061AWG28
C8	6631900108B	6P 2.0MM 700MM H-H UL1185AWG26
C9	6631T39004D	9P-9P H-H 220MM UL1007AWG18 TWI
C10	6631V39013N	8P 3.96MM 900MM H-H UL1617AWG22
JK303	6630G70016A	A03-7071-094 SPG 15P 2.29MM RGB
JK304	6630G70017A	A02-0915-101 SPG 9P 2.54MM RS232
RESISTOR		
R525	0RD0331H609	3.3 OHM 1/2 W 5.00% TA52
LED		
D1004	0DL233309AC	SAM2333 TP KWANG GREEN/RED
D750	0DL233309AC	SAM2333 TP KWANG GREEN/RED
LD101	0DLAU0410AA	AUK SAW5670 BULK AMBER/WHITE LAMP TYPE
SWITCH		
SW101	140-313B	TACT, 2LEAD 160G(TA) LG C&D 5V 0.001A
SW102	140-313B	TACT, 2LEAD 160G(TA) LG C&D 5V 0.001A
SW103	140-313B	TACT, 2LEAD 160G(TA) LG C&D 5V 0.001A
SW104	140-313B	TACT, 2LEAD 160G(TA) LG C&D 5V 0.001A
SW105	140-313B	TACT, 2LEAD 160G(TA) LG C&D 5V 0.001A
SW106	140-313B	TACT, 2LEAD 160G(TA) LG C&D 5V 0.001A

The components identified by mark  is critical for safety.
Replace only with part number specified.

LOCA. NO	PART NO	DESCRIPTION
SW107	140-313B	TACT, 2LEAD 160G(TA) LG C&D 5V 0.001A
SW108	140-313B	TACT, 2LEAD 160G(TA) LG C&D 5V 0.001A
SW501	6600VR1004A	TACT, SKHMPW 5P CHIP TACT J-ALPS .V .A
FILTER & CRYSTAL		
L100	6200J00005R	HB-1M1608-501JT CERATECH R/TP CHIP
L1000	6200J000013	MLB-321611-0500P-N2 MAG LAYERS R/TP
L1001	6200J000013	MLB-321611-0500P-N2 MAG LAYERS R/TP
L1002	6200J000013	MLB-321611-0500P-N2 MAG LAYERS R/TP
L1007	6200J000013	MLB-321611-0500P-N2 MAG LAYERS R/TP
L1008	6200J000013	MLB-321611-0500P-N2 MAG LAYERS R/TP
L101	6200J00005R	HB-1M1608-501JT CERATECH R/TP CHIP
L1010	6200J000013	MLB-321611-0500P-N2 MAG LAYERS R/TP
L1011	6200J000013	MLB-321611-0500P-N2 MAG LAYERS R/TP
L1012	6200J000013	MLB-321611-0500P-N2 MAG LAYERS R/TP
L1015	6200J000013	MLB-321611-0500P-N2 MAG LAYERS R/TP
L1016	6200J000013	MLB-321611-0500P-N2 MAG LAYERS R/TP
L1017	6200J000013	MLB-321611-0500P-N2 MAG LAYERS R/TP
L1018	6200J000013	MLB-321611-0500P-N2 MAG LAYERS R/TP
L110	6200J00005R	HB-1M1608-501JT CERATECH R/TP CHIP
L111	6200J00005R	HB-1M1608-501JT CERATECH R/TP CHIP
L112	6200J00005F	HB-1M1608-102JT CERATEC R/TP 1K OHM
L113	6200J00005F	HB-1M1608-102JT CERATEC R/TP 1K OHM
L114	6200J00005F	HB-1M1608-102JT CERATEC R/TP 1K OHM
L115	6200J00005F	HB-1M1608-102JT CERATEC R/TP 1K OHM
L300	6200JB8010L	MLB-201209-1000L-N2 MAG LAYERS R/TP
L301	6200JB8010L	MLB-201209-1000L-N2 MAG LAYERS R/TP
L302	6200J000013	MLB-321611-0500P-N2 MAG LAYERS R/TP
L303	6200J000013	MLB-321611-0500P-N2 MAG LAYERS R/TP
L304	6210TCE001E	HB-1M2012-800JT CERATEC 2012MM R/TP
L305	6200J000013	MLB-321611-0500P-N2 MAG LAYERS R/TP
L400	6200J000013	MLB-321611-0500P-N2 MAG LAYERS R/TP
L401	6200J000013	MLB-321611-0500P-N2 MAG LAYERS R/TP
L402	6200J000013	MLB-321611-0500P-N2 MAG LAYERS R/TP
L500	6200J000013	MLB-321611-0500P-N2 MAG LAYERS R/TP
L501	6200J000013	MLB-321611-0500P-N2 MAG LAYERS R/TP
L502	6200J000013	MLB-321611-0500P-N2 MAG LAYERS R/TP
L806	6200J000013	MLB-321611-0500P-N2 MAG LAYERS R/TP
L813	6200J000013	MLB-321611-0500P-N2 MAG LAYERS R/TP
L814	6200J000013	MLB-321611-0500P-N2 MAG LAYERS R/TP
L819	6200J000013	MLB-321611-0500P-N2 MAG LAYERS R/TP
L820	6200J000013	MLB-321611-0500P-N2 MAG LAYERS R/TP
L904	6200J000013	MLB-321611-0500P-N2 MAG LAYERS R/TP
L905	6200J000013	MLB-321611-0500P-N2 MAG LAYERS R/TP
L906	6200J000013	MLB-321611-0500P-N2 MAG LAYERS R/TP
L913	6200J000013	MLB-321611-0500P-N2 MAG LAYERS R/TP
L914	6200J000013	MLB-321611-0500P-N2 MAG LAYERS R/TP
L915	6200J000013	MLB-321611-0500P-N2 MAG LAYERS R/TP
L916	6200J000013	MLB-321611-0500P-N2 MAG LAYERS R/TP
L917	6200J000013	MLB-321611-0500P-N2 MAG LAYERS R/TP
L918	6200J000013	MLB-321611-0500P-N2 MAG LAYERS R/TP
L919	6200J000013	MLB-321611-0500P-N2 MAG LAYERS R/TP

LOCA. NO	PART NO	DESCRIPTION
L920	6200J000013	MLB-321611-0500P-N2 MAG LAYERS R/TP
L921	6200J000013	MLB-321611-0500P-N2 MAG LAYERS R/TP
L924	6200J000013	MLB-321611-0500P-N2 MAG LAYERS R/TP
X600	6202VDT002P	CRYSTAL, HC-49/SM 20.25000MHZ +/-30PPM
JACK		
JK100	6612J00043C	SCART, UPJ-R1-031 UGCOM S/T,SCART..
JK101	6612J00043C	SCART, UPJ-R1-031 UGCOM S/T,SCART..
JK102	6612J10025A	RCA, KCN-BT-0-0055 10MM PAL TUNER JACK
JK103	6612J10031A	RCA, PPJ209-02 PARK 5P RCA(GBRWR)
JK105	6612J10003W	RCA, PPJ148-13 PARK ELEC. S/T 3P YWR
JK106	6612F00024C	DIN, PSJ014-01 PARK ELEC. S-VHS JACK..
JK300	6612F00099A	PHONE, PEJ024-01 PARK 7P 10MM WITH S/W..
JK300	6612J10003X	RCA, PMJ6054-39 PARK ELEC. R/A 3P YWR..
JK301	6612F00099A	PHONE, PEJ024-01 PARK 7P 10MM WITH S/W..
JK302	6612F00099A	PHONE, PEJ024-01 PARK 7P 10MM WITH S/W..
JK400	6612B00015B	DIN, DC1R019WDH JAE 0.5MM,
JK800	6612J10043A	RCA, PPJ200-07 PARK 2P S/T SH LF
WAFER		
C11	366-036B	CONNECTOR (CIRC),WAFERSTAPLE
C12	366-036B	CONNECTOR (CIRC),WAFERSTAPLE
C13	366-036B	CONNECTOR (CIRC),WAFERSTAPLE
P1	6602T20009C	CONNECTOR (CIRC),WAFERSMAW200-04
P100	6602T20009J	CONNECTOR (CIRC),WAFERSMAW200-10
P1001	6602T25008J	WAFER, SMW250-10
P101	6602T20009C	CONNECTOR (CIRC),WAFERSMAW200-04
P300	6602T20009E	CONNECTOR (CIRC),WAFERSMAW200-06
P300	6602T20009E	CONNECTOR (CIRC),WAFERSMAW200-06
P301	6602T20008J	CONNECTOR (CIRC),WAFERSMW200-10
P302	6630V25002F	CONNECTOR (CIRC),WAFERYFDW254
P303	366-932B	CONNECTOR (CIRC),WAFERIL-G-03P
P304	6630VF00704	CONNECTOR (CIRC),WAFER12505WS-04A00
P601	6602T12007D	CONNECTOR (CIRC),WAFERGT121-31P-TD
P801	6602T25008C	CONNECTOR (CIRC),WAFERSMW250-04
P802	6602T25008B	CONNECTOR (CIRC),WAFERSMW250-03
P900	6602T25008M	WAFER, SMW250-13
MISCELLANEOUS		
CA1	6850J00005C	CABLE,DVILVDS UL20276 AWG30 600MM
CA2	68509A0004E	CABLE,COAXIAL RCA R/A UL 1365#26 VW-1
PA101	6712000011B	REMOTE CONTROLLER RECEIVER
TU1	6700MF0017C	TUNER, TAFV-W303P LGIT MULTI FS
ACCESSORIES		
A1	38289U0025B	MANUAL, USER LP61A BRAND 8LANS
	38289U0323B	MANUAL, USER 8LANS WESTERN EUROPE
	38289U0323R	MANUAL, USER LP61A RU/EN(2) 010G-TX
	38289U0025Z	MANUAL, USER All EU RS-232C
A2	6710900010G	REMOTE CONTROLLER, PP62A
 A3	64109EP003A	POWER CORD, LP34A+LS60 LONGWELL
A4	4972V00178B	FIXER, WALL ASSY FOLDING STAND ONLY

SI15100 Decoupling Capacitors

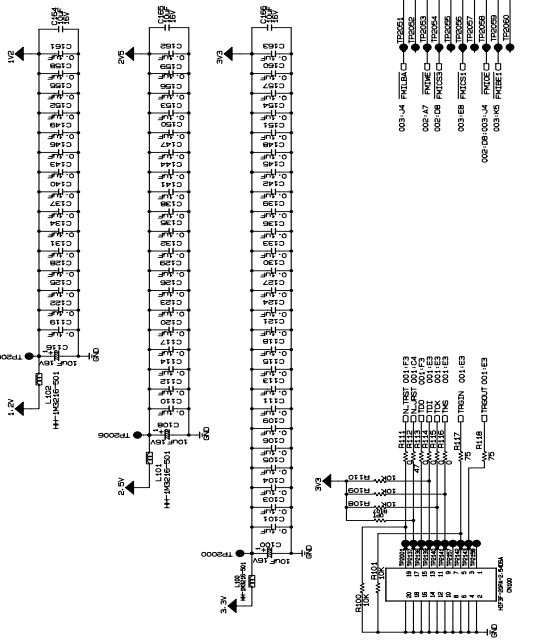

MAIN

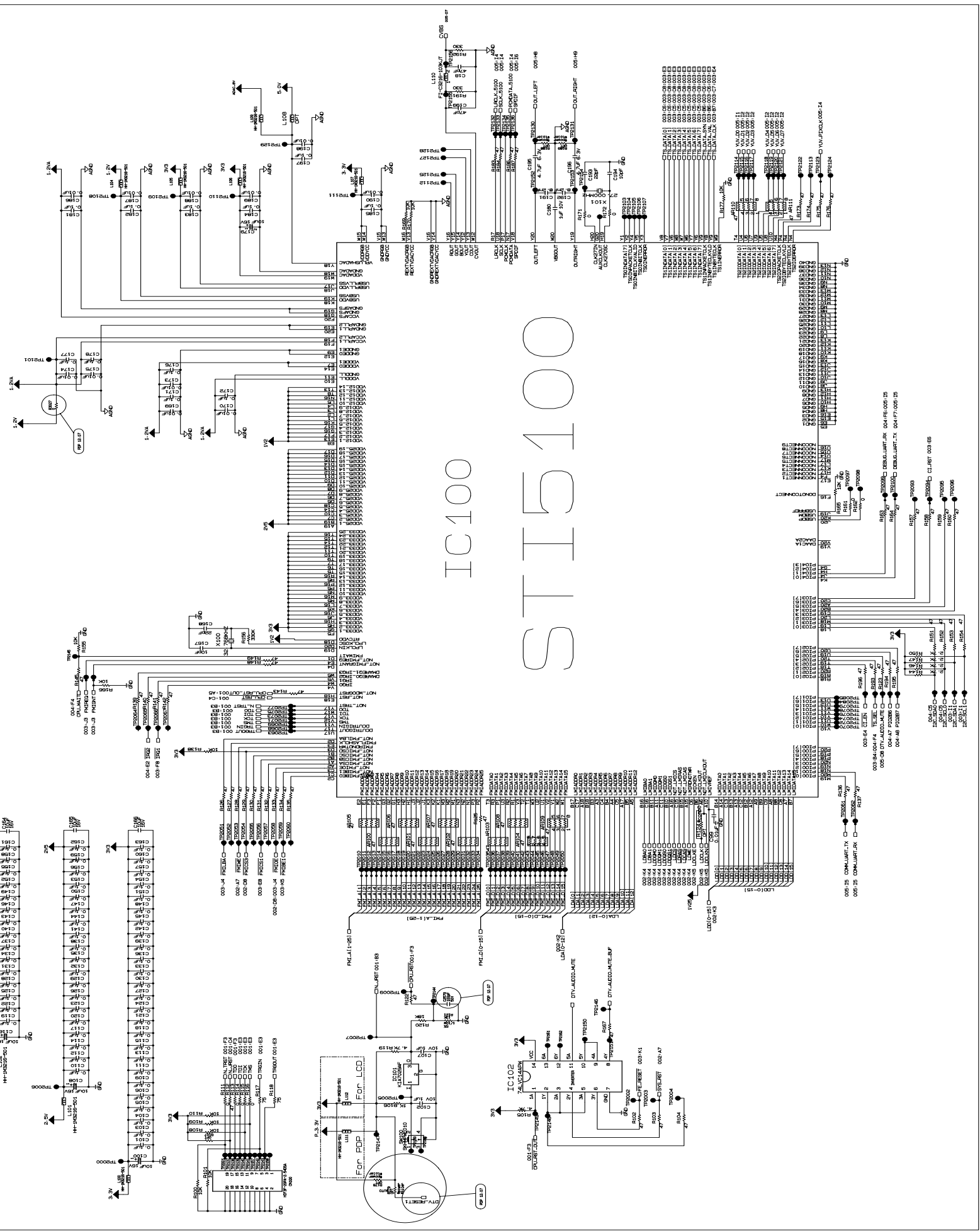

IC100
ST15100

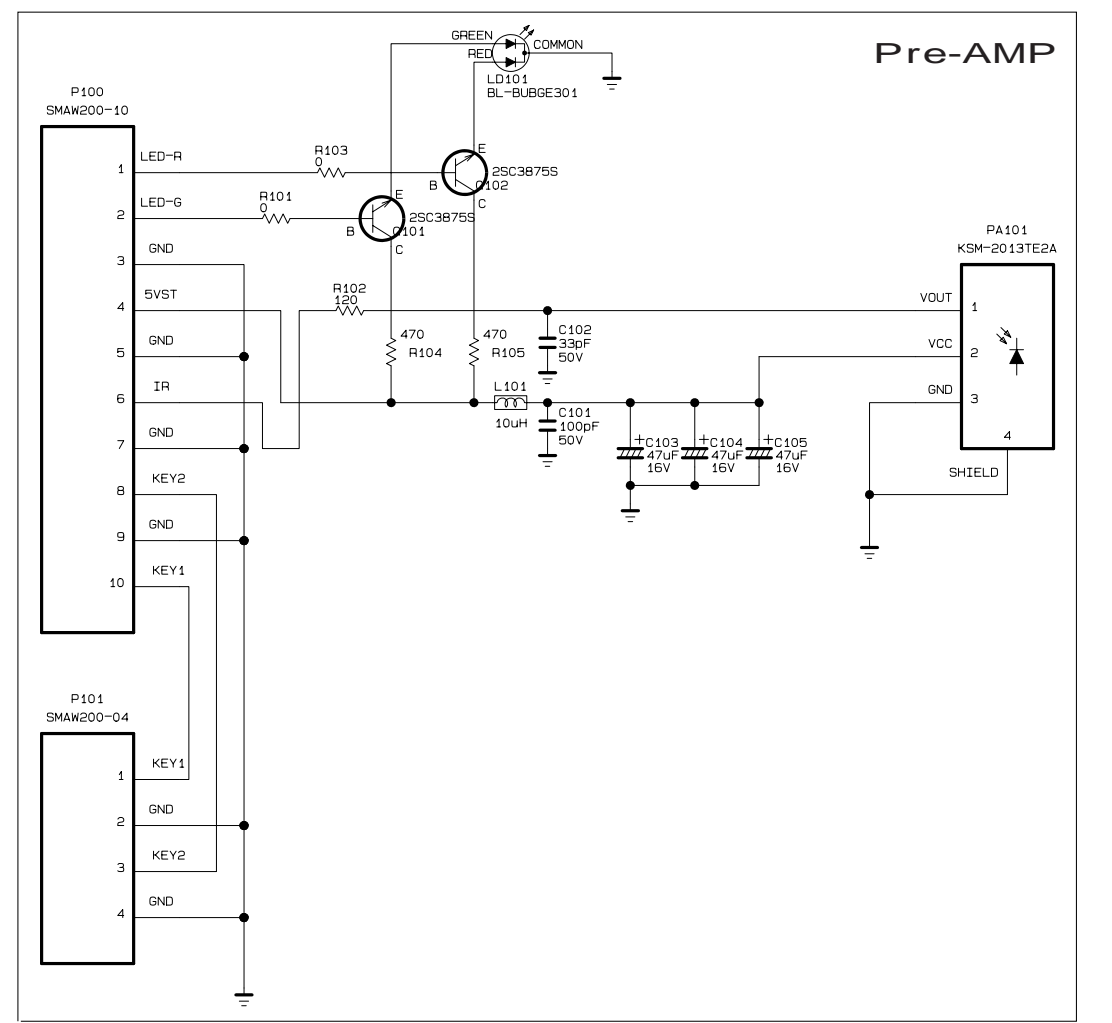
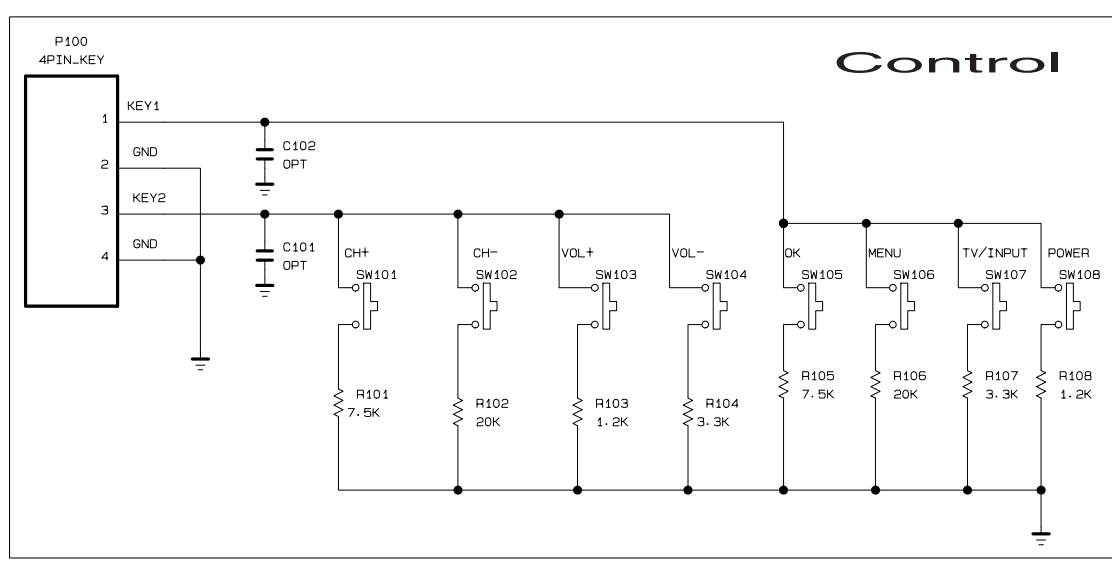

AV JACK

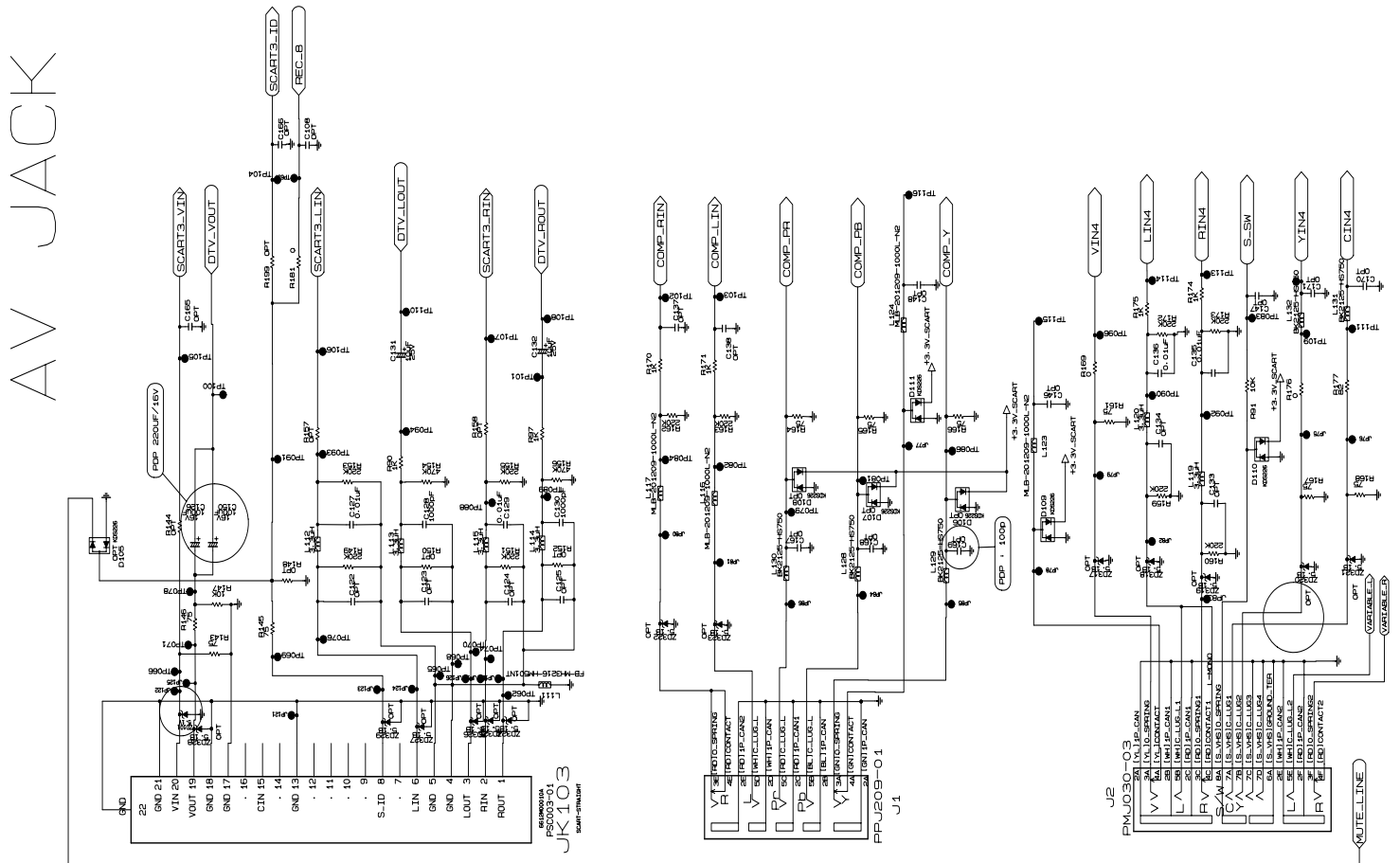
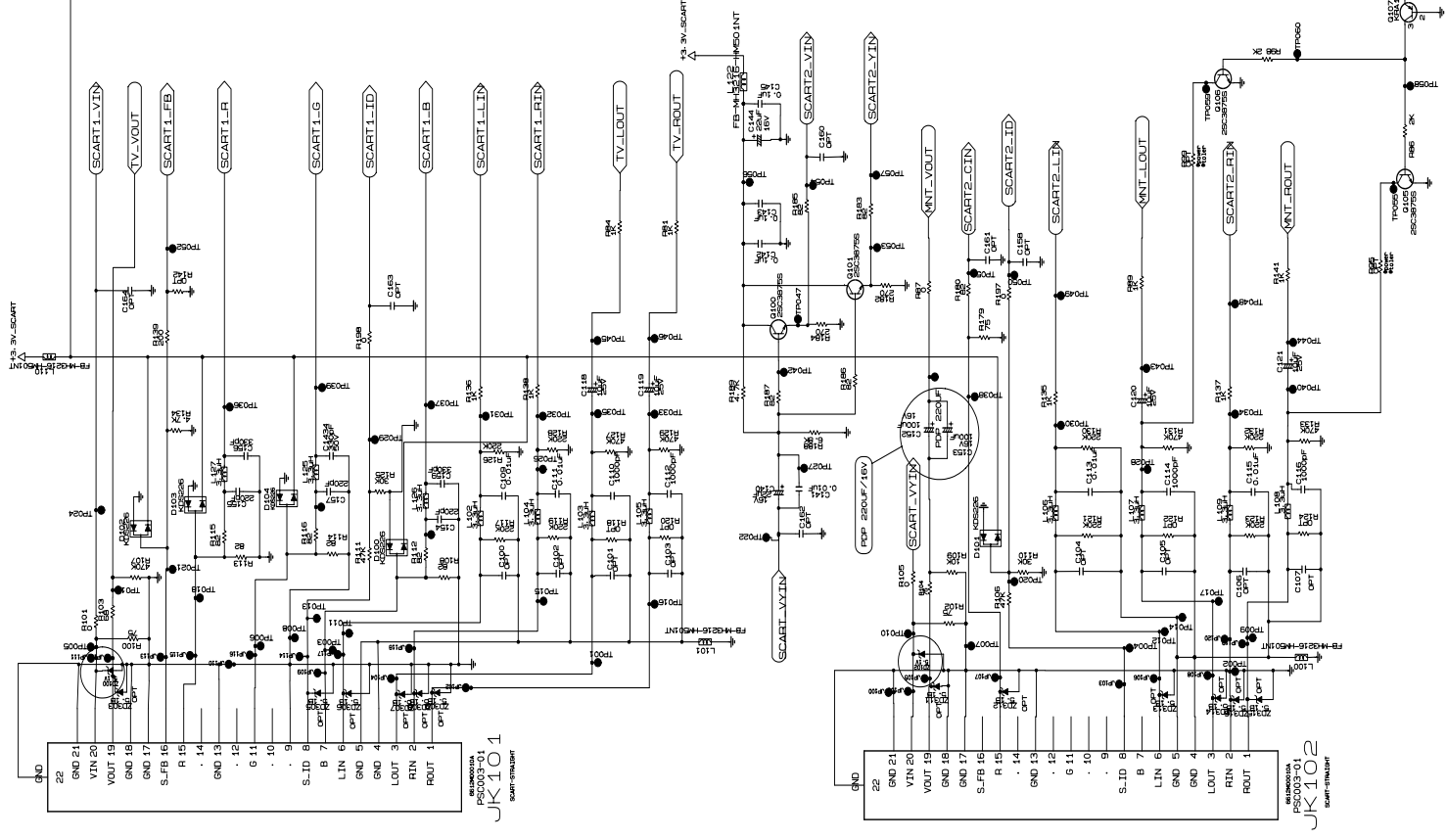

SIDE AV B/D

JK101
UJB-03-28A

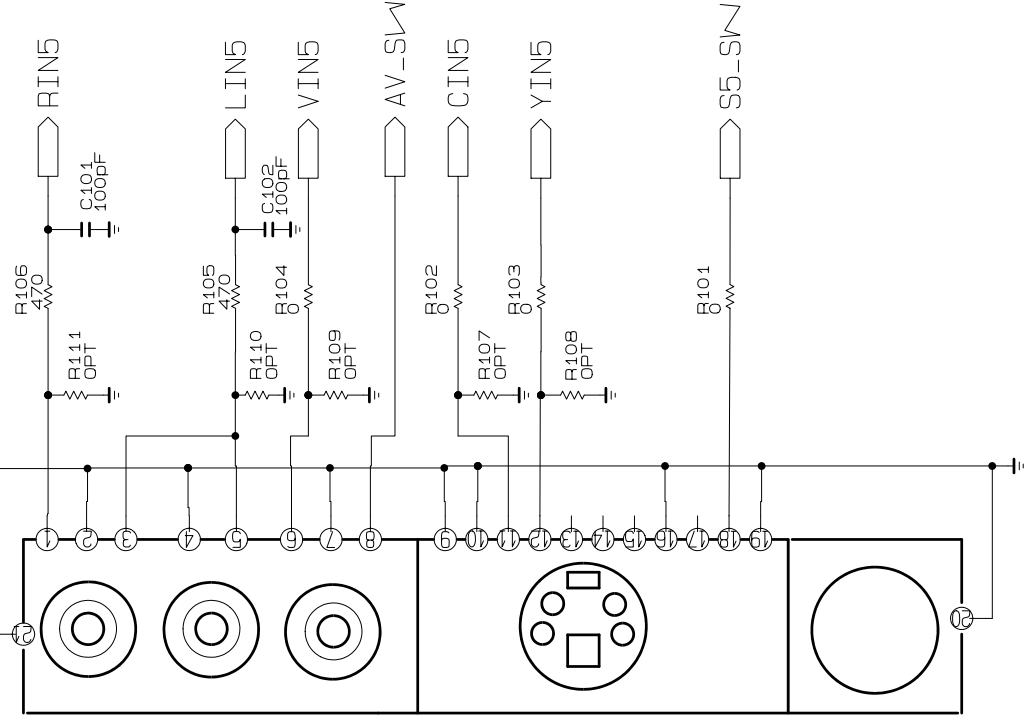

RT	RZ	VGA	RZ	XGA	NTSC
C101	100pF		100pF		OPT
C102	100pF		100pF		OPT
R101	0		0		0
R102	0		0		6200JB8010L
R103	0		0		6200JB8010L
R104	0		0		82
R105	3.3uH		470		6200JB8010L
R106	3.3uH		470		6200JB8010L
R107	OPT		OPT		68(S5-07489)
R108	OPT		OPT		82
R109	OPT		OPT		82
R110	OPT		OPT		220K
R111	OPT		OPT		220K

TO VSC BOARD

P101
SMAW200-12

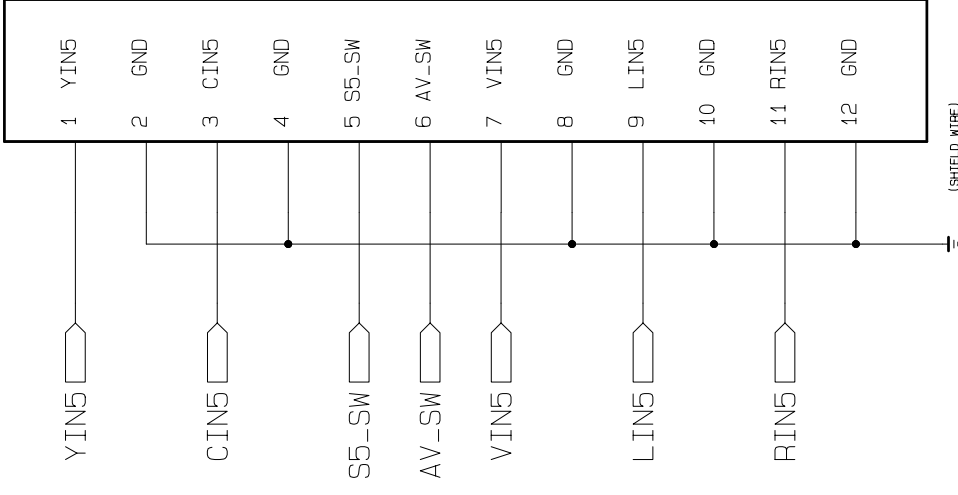

(SHIELD WIRE)



P/NO : 38289S0023C

Mar., 2006
Printed in Korea

