



website:<http://biz.LGservice.com>
e-mail:<http://www.LGservice.com/techsup.html>

PLASMA TV

SERVICE MANUAL

CHASSIS : MF-056C

MODEL : 42PX3RVA
42PX3RVA-ZC

CAUTION

BEFORE SERVICING THE CHASSIS,
READ THE SAFETY PRECAUTIONS IN THIS MANUAL.

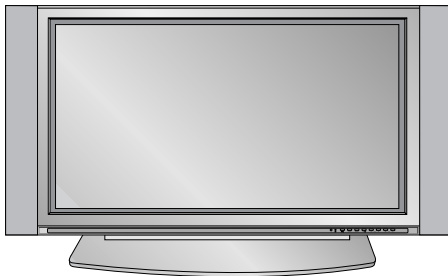

CONTENTS

SAFETY PRECAUTIONS	3
DESCRIPTION OF CONTROLS	4
SPECIFICATIONS	9
ADJUSTMENT INSTRUCTIONS	11
TROUBLE SHOOTING GUIDE	15
BLOCK DIAGRAM	24
EXPLODED VIEW	26
EXPLODED VIEW PARTS LIST	27
REPLACEMENT PARTS LIST	28
SCHEMATIC DIAGRAM	
PRINTED CIRCUIT BOARD	

SAFETY PRECAUTIONS

IMPORTANT SAFETY NOTICE

Many electrical and mechanical parts in this chassis have special safety-related characteristics. These parts are identified by \triangle in the Schematic Diagram and Replacement Parts List.

It is essential that these special safety parts should be replaced with the same components as recommended in this manual to prevent X-RADIATION, Shock, Fire, or other Hazards.

Do not modify the original design without permission of manufacturer.

General Guidance

An **isolation Transformer should always be used** during the servicing of a receiver whose chassis is not isolated from the AC power line. Use a transformer of adequate power rating as this protects the technician from accidents resulting in personal injury from electrical shocks.

It will also protect the receiver and its components from being damaged by accidental shorts of the circuitry that may be inadvertently introduced during the service operation.

If any fuse (or Fusible Resistor) in this monitor is blown, replace it with the specified.

When replacing a high wattage resistor (Oxide Metal Film Resistor, over 1W), keep the resistor 10mm away from PCB.

Keep wires away from high voltage or high temperature parts.

Due to high vacuum and large surface area of picture tube, extreme care should be used in **handling the Picture Tube**. Do not lift the Picture tube by its Neck.

Leakage Current Cold Check(Antenna Cold Check)

With the instrument AC plug removed from AC source, connect an electrical jumper across the two AC plug prongs. Place the AC switch in the on position, connect one lead of ohm-meter to the AC plug prongs tied together and touch other ohm-meter lead in turn to each exposed metallic parts such as antenna terminals, phone jacks, etc.

If the exposed metallic part has a return path to the chassis, the measured resistance should be between $1M\Omega$ and $5.2M\Omega$.

When the exposed metal has no return path to the chassis the reading must be infinite.

An other abnormality exists that must be corrected before the receiver is returned to the customer.

Leakage Current Hot Check (See below Figure)

Plug the AC cord directly into the AC outlet.

Do not use a line Isolation Transformer during this check.

Connect 1.5K/10watt resistor in parallel with a 0.15uF capacitor between a known good earth ground (Water Pipe, Conduit, etc.) and the exposed metallic parts.

Measure the AC voltage across the resistor using AC voltmeter with 1000 ohms/volt or more sensitivity.

Reverse plug the AC cord into the AC outlet and repeat AC voltage measurements for each exposed metallic part. Any voltage measured must not exceed 0.75 volt RMS which is corresponds to 0.5mA.

In case any measurement is out of the limits specified, there is possibility of shock hazard and the set must be checked and repaired before it is returned to the customer.

Leakage Current Hot Check circuit

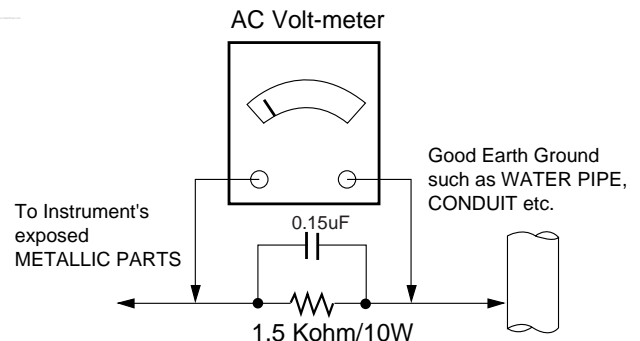

DESCRIPTION OF CONTROLS

Remote Control Key Functions

- When using the remote control aim it at the remote control sensor of the set.
- There's maybe a defect in consecutive operation of remote control in specified brightness according to this set feature.

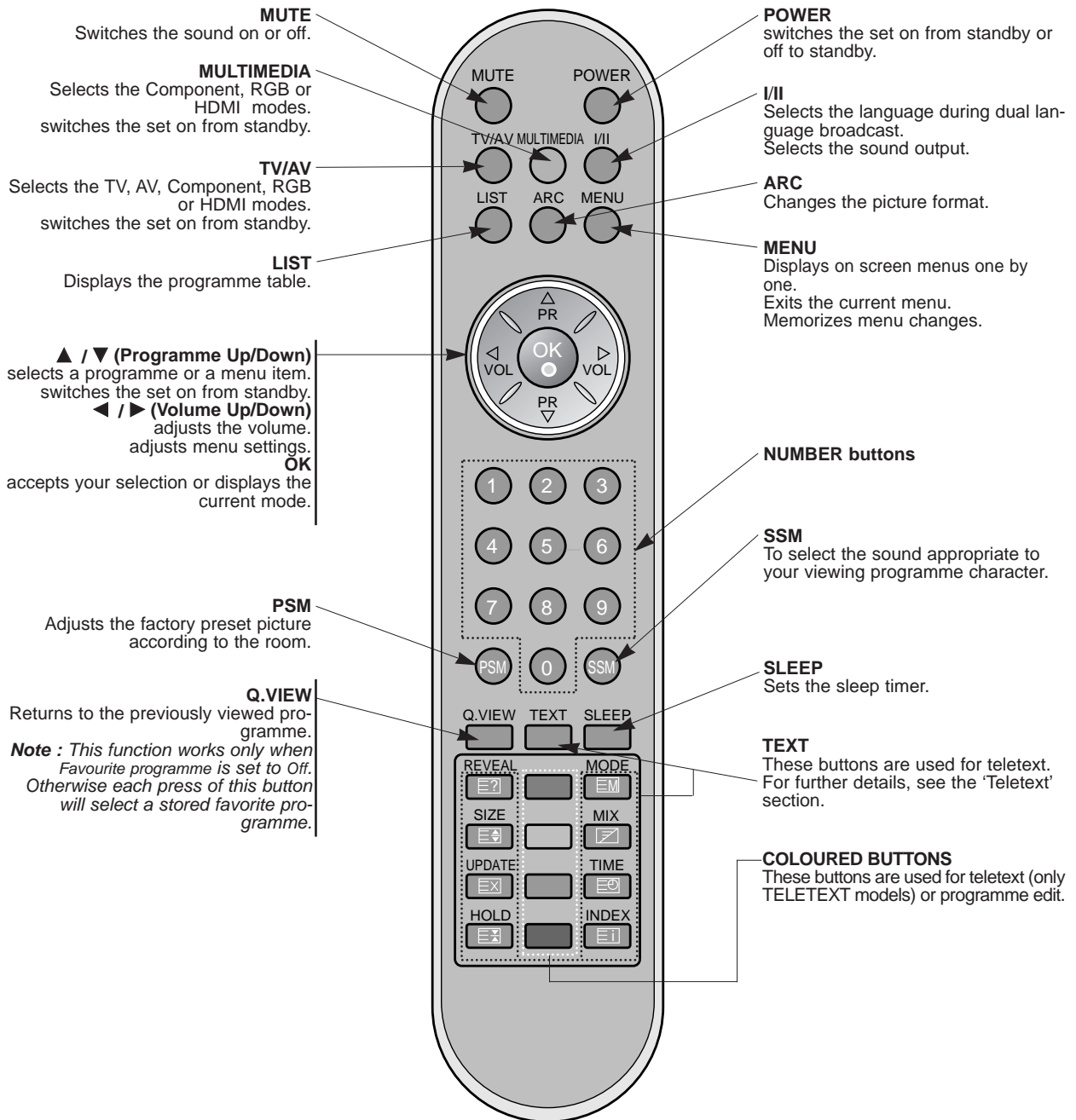

Location and Function of Controls

<Front Panel Controls>

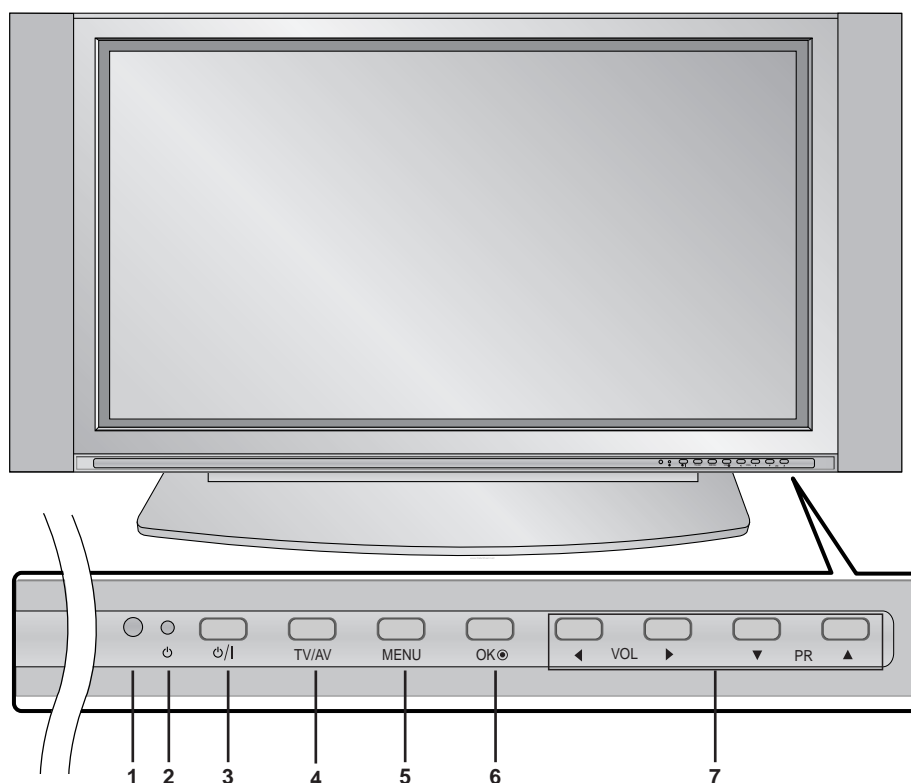

- 1. Remote Control Sensor**
- 2. Power Indicator**
Illuminates red in standby mode, Illuminates green when the set is turned on.
- 3. Power Button**
Switches the set on from standby or off to standby.
- 4. TV/AV Button**
Selects the TV, AV, Component, RGB or HDMI modes.
Switches the set on from standby.
- 5. MENU**
Displays on screen menus one by one.
Exits the current menu.
Memorizes menu changes.
- 6. OK**
Accepts your selection or displays the current mode.
- 7. ▲ / ▼ (Programme Up/Down)**
Selects a programme or a menu item.
Switches the set on from standby.
◀ / ▶ (Volume Up/Down)
Adjusts the volume.
Adjusts menu settings.

Location and Function of Controls

- Shown is a simplified representation of the set.
- Here shown may be somewhat different from your set.

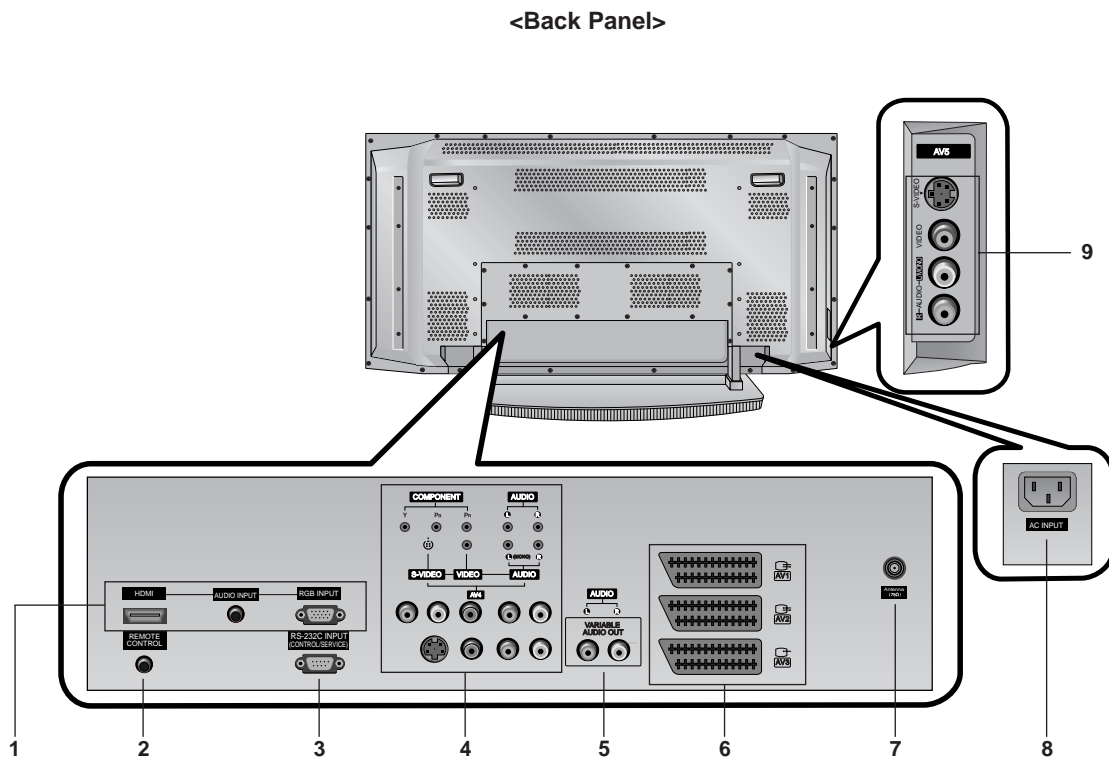

1. HDMI(DVI VIDEO) / AUDIO INPUT / RGB INPUT

Connect the monitor output socket of the PERSONAL COMPUTER, DVD or STB to this socket.

Note: If you want to use RGB/DVI audio, we strongly recommend that you use the cable that has a core, or the EMI Filter core along with separate cable.

2. CONTROL LOCK / REMOTE CONTROL

3. RS-232C INPUT(CONTROL/SERVICE) PORT

Connect to the RS-232C port on a PC.

4. COMPONENT INPUT

Connect DVD video outputs to Y, P_B, P_R of COMPONENT INPUT and audio outputs to Audio sockets of AUDIO INPUT.

AUDIO/VIDEO IN SOCKETS (AV4)

Connect the audio/video out sockets of external equipment to these sockets.

S-VIDEO/AUDIO IN SOCKETS

Connect the S-VIDEO out socket of an VCR to the **S-VIDEO** socket.

Connect the audio out sockets of the VCR to the audio sockets as in **AV4**.

5. VARIABLE AUDIO OUTPUT

6. EURO SCART SOCKET

Connect the euro scart socket of the VCR to these sockets.

Note: If you want to use the EURO scart cable, you have to use the signal shielded Euro scart cable.

7. ANTENNA INPUT

8. POWER CORD SOCKET

This set operates on an AC power. The voltage is indicated on the Specifications page. Never attempt to operate the set on DC power.

9. AUDIO/VIDEO INPUT (AV5) S-VIDEO/AUDIO IN SOCKETS

Displayable Monitor Specification

RGB / HDMI mode

Resolution	Horizontal Frequency(KHz)	Vertical Frequency(Hz)
640x350	31.468	70.09
	37.861	85.08
720x400	31.469	70.08
	37.927	85.03
640x480	31.469	59.94
	35.000	66.66
	37.861	72.80
	37.500	75.00
848x480	43.269	85.00
	31.500	60.00
	37.799	70.00
	39.375	75.00
852x480	31.500	60.00
	37.799	70.00
	39.375	75.00
800x600	35.156	56.25
	37.879	60.31
	48.077	72.18
	46.875	75.00
832x624	53.674	85.06
	49.725	74.55
	48.363	60.00
1024x768	56.476	70.06
	60.023	75.02
	68.677	85.00
	54.348	60.05
1152x864	63.995	70.01
	67.500	75.00
1152x870	68.681	75.06
1280x960	60.023	60.02
1280x1024	63.981	60.02

42PX3RV series

RGB / HDMI mode

Resolution	Horizontal Frequency(KHz)	Vertical Frequency(Hz)
640x350	31.468	70.09
	37.861	85.08
720x400	31.469	70.08
	37.927	85.03
640x480	31.469	59.94
	35.000	66.66
	37.861	72.80
	37.500	75.00
848x480	43.269	85.00
	31.500	60.00
	37.799	70.00
	39.375	75.00
852x480	31.500	60.00
	37.799	70.00
	39.375	75.00
800x600	35.156	56.25 (RGB)
	37.879	60.31
	48.077	72.18
	46.875	75.00
832x624	53.674	85.06
	49.725	74.55
	48.363	60.00
1024x768	56.476	70.06
	60.023	75.02
	68.677	85.00
	47.700	60.00
1360x768	59.625	75.02
	68.500	85.00
1366x768	47.700	60.00
	59.625	75.02
1152x864	69.500	85.00
	54.348	60.05
	63.995	70.01
1152x870	67.500	75.00
	77.487	85.00
1152x870	68.681	75.06
1280x768	47.693	60.00
	60.091	75.00
1280x960	68.504	85.00
	60.023	60.02
1280x1024	63.981	60.02

50PX3R series

Accessories



Owner's Manual



Remote Control handset



2-Eye Bolts

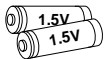

Alkaline batteries



Power Cord



2-Wall brackets

Joining the set assembly to the wall to protect the set tumbling

- Secure the set assembly by joining it to a wall by using the Eye Bolts/Wall brackets.

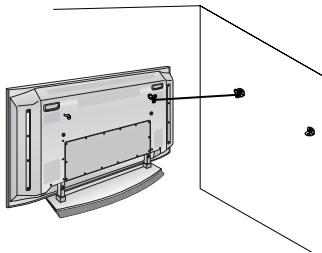

- After the set must be mounted on a desktop, install the Eye Bolts on the set as shown.
Insert the 2 Eye Bolts and tighten securely, in the holes on the bracket.
Install the wall brackets on the wall with 2 bolts, (not supplied with the product), as shown.
Match the height of the Eye Bolts and the wall brackets.
Check to be sure the brackets are tightened securely.

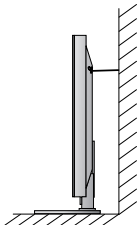

- Secure the set assembly to the wall with strong strings or wound wire cables, (not supplied with the product), as shown.

Optional Extras

- Optional extras can be changed or modified for quality improvement without any notification new optional extras can be added.
- Contract your dealer for buying these items.

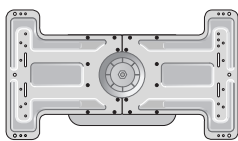

Tilt wall mounting bracket

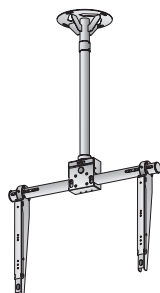

Ceiling mounting bracket



Video cables

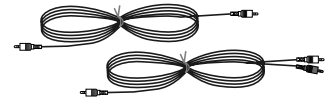

Audio cables

SPECIFICATIONS

NOTE : Specifications and others are subject to change without notice for improvement.

■ Application Range

This spec is applied to the 42"PDP TV used MF-056C Chassis.

■ Specification

Each part is tested as below without special appointment.

- 1) Temperature : 25±5°C (77±9°F), CST : 40±5
- 2) Relative Humidity: 65±10%
- 3) Power Voltage: Standard Input voltage (100-240V~, 50/60Hz)
* Standard Voltage of each product is marked by models.
- 4) Specification and performance of each parts are followed each drawing and specification by part number in accordance with BOM.
- 5) The receiver must be operated for about 20 minutes prior to the adjustment.

■ Test Method

- 1) Performance : LGE TV test method followed.
- 2) Demanded other specification
Safety: CE, IEC specification
EMC : CE, IEC

Model Name	Market	Remark
42PX3RVA-ZC	EU	Safety : IEC/EN60065, EMI : EN55013, EMS : EN55020

■ General Specification

1. General Specification

No	Item	Specification	Remark
1	Display Screen Device	42 inch wide Color Display Module	PDP
2	Aspect Ratio	16:9	
3	PDP Module	PDP42V7xxxx RGB Closed Type, Film Filter	
4	Operating Environment	1) Temp : 0~40 deg 2) Humidity : 0~85%	LGE SPEC
5	Storage Environment	1) Temp : -20~60 deg 2) Humidity : 0~85%	
6	Input Voltage	100-240V~, 50/60Hz	Maker : SONY/ Sanken

2. Model Specification(42PX3RVA-ZA)

No	Item	Specification			Remark
1	Market	EU			
2	Broadcasting system	PAL B/G/I/D/K, SECAM L/L'			
3	Available channel	BRAND	PAL	SECAM	
		VHF/UHF	C1~C69		
		CATV	S1~S47		
4	Receiving system	Upper Heterodyne			
5	Scart Jack(3EA)	PAL, SECAM			
6	Video input(2EA)	PAL, SECAM, NTSC			4 System : PAL, SECAM, NTSC,PAL60
7	S-Video Input(2EA)	PAL, SECAM, NTSC			4 System : PAL, SECAM, NTSC,PAL60
8	Component Input(2EA)	Y/Cb/Cr, Y/Pb/Pr			
9	RGB Input(1EA)	RGB-PC			
		RGB-DTV			
10	HDMI Input(1EA)	HDMI-PC			
		HDMI-DTV			
11	Audio Input(4EA)	PC Audio(1EA), Component, AV(2EA)			L/R Input
12	Audio Output(1EA)	Variable Audio Out			L/R Output
13	Wired Control	Discrete IR			

ADJUSTMENT INSTRUCTIONS

1. Application Object

These instructions apply to the MF-056C Chassis.

2. Specification

- (1) Because this is not a hot chassis, it is not necessary to use an isolation transformer. However, the use of isolation transformer will help protect test instrument.
- (2) Adjustment must be done in the correct order.
- (3) The adjustment must be performed in the circumstance of 25±5°C of temperature and 65±10% of relative humidity if there is no specific designation.
- (4) The input voltage of the receiver must keep 100-220V, 50/60Hz.
- (5) The receiver must be operated for about 15 minutes prior to the adjustment.

- After RGB Full white HEAT-RUN Mode, the receiver must be operated prior to adjustment.
- Enter into HEAT-RUN MODE
 - 1) Press the POWER ON KEY on R/C for adjustment.
 - 2) OSD display and screen display 100% full WHITE PATTERN.

- * Set is activated HEAT-RUN without signal generator in this mode.
- * Single color pattern(RED/BLUE/GREEN) of HEAT-RUN mode uses to check PANEL.

Caution) If you turn on a still screen more than 20 minutes (Especially digital pattern, cross hatch pattern), after image may occur in the black level part of the screen.

3. Channel memory

3-1. Setting up the LGIDS

- 1) Install the LGIDS. (idsinst.exe)
- 2) After installation, restart your PC.
- 3) Extract [files.zip] to folder [c:\LGIDS\files].
- 4) Start LGIDS.

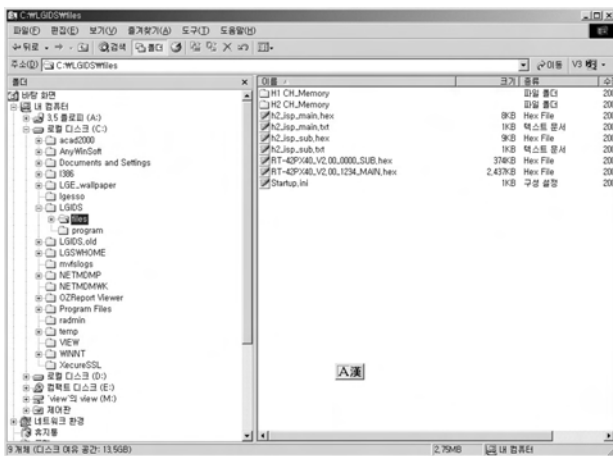

(Fig. 1)

3-2. Channel memory Method

- 1) Select "PDP" and "Hurricane" on Model dialog. And check your connection in Communication dialog. (If your connection is 'NG', then set your PORT(COM1,2,3,...) correctly.)
- 2) Connect RS-232C cable and turn on the power. (If your connection has completed, you can see "Ready".)

* If your set is not an end products but only a board, you have to make your board to Stand-by state (LED_R). And you have to Download in Stand_by power state.

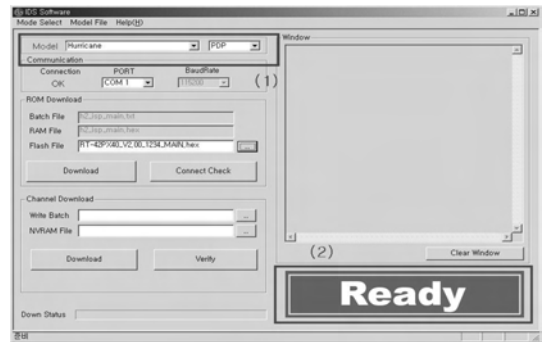

(Fig. 2)

- 3) Select proper CH_memory file(*.nvm) for each model at [NVRAM Download] → [Write Batch] Next, select proper binary file(*.bin) including the CH information for each model at [NVRAM File].
- 4) Click the [Download] button. It means the completion of the CH memory download if all items show 'OK' and Status is changed by 'PASS' at the lower right corner of the window.
- 5) If you want to check whether the CH information is memorized correctly or not, click the [Verify] button. And then compare NVRAM File(*.bin) with the CH information downloaded.

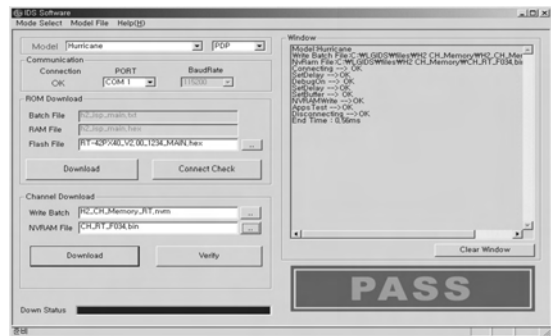

(Fig. 3)

Each PCB assembly must be checked by check JIG set.
(Because power PCB Assembly damages to PDP Module, especially be careful)

4. POWER PCB Assy Voltage Adjustments (Va, Vs Voltage Adjustments)

4-1. Test Equipment : D.M.M. 1EA

4-2. Adjustment Method [P/No 3501V00220A(Sanken) B/D, P/No 6709V00010A(LGIT) B/D]

(1) Va Adjustment

- 1) After receiving 100% Full White Pattern, HEAT RUN.
- 2) Connect + terminal of D.M.M to Va pin of P807, connect - terminal to GND pin of P807.
- 3) After turning RV501, voltage of D.M.M adjustment as same as Va voltage which on label of panel right/top. (Deviation; $\pm 0.5V$)

(2) Vs Adjustment

- 1) Connect + terminal of D.M.M to Vs pin of P807, connect - terminal to GND pin of P807.
- 2) After turning RV401, voltage of D.M.M adjustment as same as Vs voltage which on label of panel right/top. (Deviation; $\pm 0.5V$)

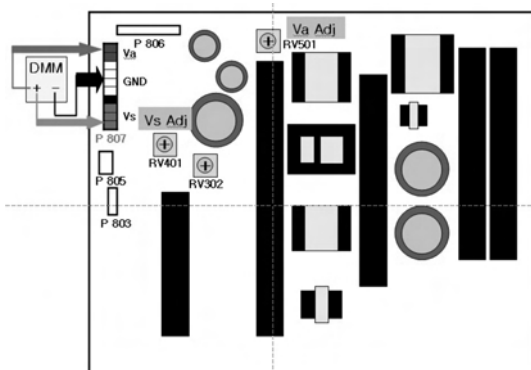

(Fig. 4) Connection diagram of power adjustment for measuring

5. EDID (The Extended Display Identification Data)/ DDC (Display Data Channel) download

5-1. Required Test Equipment

- 1) Adjusting PC with S/W for writing EDID Data.(S/W : EDID TESTER Ver.2.5)
- 2) A Jig for EDID Download
- 3) Cable : Serial(9Pin or USB) to D-sub 15Pin cable, D-sub 15Pin cable, DVI to HDMI cable.

5-2. Setting of device

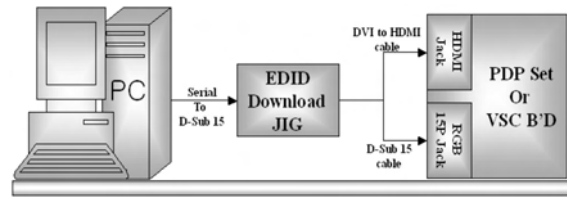

(Fig. 5) Connection Diagram of DDC download

5.3. Preparation for Adjustment

- 1) As above Fig. 5, Connect the Set, EDID Download Jig, PC & Cable.
- 2) Turn on the PC & EDID Download Jig. And Execute the S/W : EDID TESTER Ver,2.5
- 3) Set up S/W option
Repeat Number : 5
Device Address : A0
PageByte : 8
- 4) Power on the Set

5.4. Sequence of Adjustment

(1) DDC data of Analog-RGB

- 1) Init the data

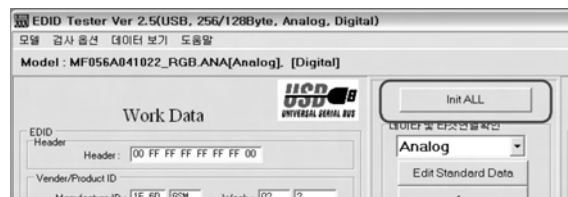

- 2) Load the EDID data.(Open File)
[Analog-RGB : TYPE_VGA.ANA]
[Digital(HDMI) : TYPE_VGA.DVI]

- 3) Set the S/W as below.

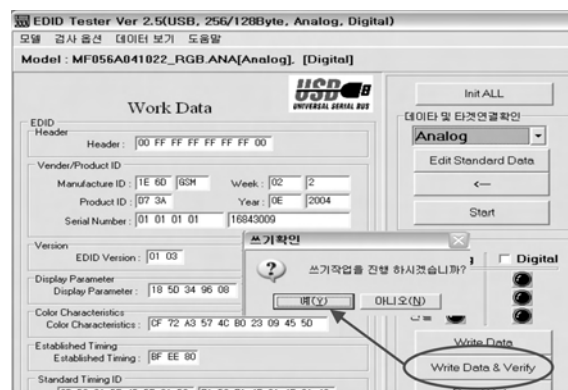

- 4) Push the "Write Data & Verify"button. And confirm "Yes".
- 5) If the writing is finished, you will see the "OK" message.

6. Auto AV(CVBS) Color Balance

6-1. Requirement

- This AV color balance adjustment should be performed before White Balance Adjustment.

6-2. Required Equipme

- 1) Remote controller for agdjustment
- 2) AV Pattern Generator : 802F Pattern Generator, Master (MSPG-925FA), etc (Which has PAL Composite Video format output with standard (1.0 Vpp) Vertical 100% Color Bar Pattern as Fig.6)

6-3 Method of Auto RGB Color Balance

- 1) Input the PAL Composite Video (Fig.6.100% Color Bar Pattern) into video input. (RZ-42PX30 : AV4/AV5 Input 50Hz)
- 2) Set the PSM to Standard mode in Picture menu.
- 3) Press INSTART key on R/C for adjustment.
- 4) Press the ► (Vol. +) key operat to set, then it becomes automatically.
- 5) Auto-RGB OK means completed adjustment.

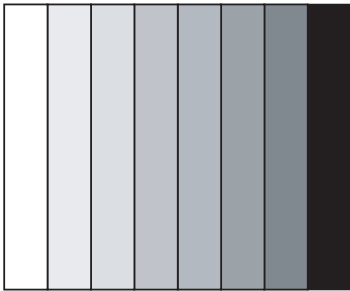

(Fig. 6) Auto AV(CVBS) Color Balance Test Pattern

7. Adjustment of White Balance

7-1. Required Equipment

- 1) Remote controller for adjustment
- 2) Color Analyzer (CA-100 or same product)
- 3) Auto W/B adjustment instrument(only for auto adjustment)
- 4) AV Pattern Generator

7-2. Connecting diagram of equipment for measuring (For Auto Adjustment)

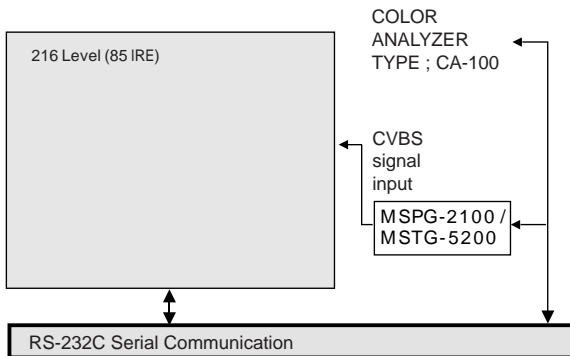

(Fig. 7) Connection Diagram of Auto W/B Adjustment

◆ Auto adjustment Map(RS-232C)

MF-056C : RZ-42PX30						
Type	RS232					
Baud Rate	Data bit	Stop bit	Parity			
115200	8	1	NONE			
Protocol Setting	Index	Cmd1	Cmd2	Data	Min Value	Max Value
	R Gain	j	a		00(00)	255(FF)
	G Gain	j	b		00(00)	255(FF)
	B Gain	j	c		00(00)	255(FF)
	R Offset	j	d		00(00)	255(FF)
	G Offset	j	e		00(00)	255(FF)
	B Offset	j	f		00(00)	255(FF)

7-3. Adjustment of White Balance

- Operate the zero-calibration of the CA-100, then stick sensor to PDP module surface when you adjust.
- For manual adjustment, it is also possible by the following sequence.

- 1) Select white pattern of heat-run mode by pressing power on key on remote control for adjustment then operate heat run more than 15 minutes.
- 2) As below Fig.7, Supply Window or Gray step pattern to Video input (RZ-42PX30 : AV4/AV5 INPUT 50Hz)
- 3) Press the TV/AV KEY on R/C for converting input mode.
- 4) Set the PSM to Standard mode in Picture menu.
- 5) Enter the White Balance adjustment mode by pressing the INSTART key twice(White Balance) on R/C
- 6) Stick sensor to center of the screen and select each items (Red/Green/Blue Gain and offset) using ▲/▼(CH +/-) key on R/C.
- 7) Adjust High Light with R Gain/ B Gain and Low light with G Offset/ B Offset using ◀/▶(VOL +/-) key on R/C.
- 8) Adjust it until color coordination becomes as below.
(G Gain:7A/ R Offset:7F/ G Offset:7E/ B offset:80 is Fixed)
[MF-056C : RZ-42PX30] - VGA 42"
Bright : High Light : $60 \pm 20 \text{ Cd/m}^2$
Color-Coordinate : High Light : X : 0.285 ± 0.003
Y : 0.290 ± 0.003
Color Temperature : $9,300^\circ\text{K} \pm 500^\circ\text{K}$
- 9) When adjustment is completed, Exit adjustment mode using EXIT key on R/C

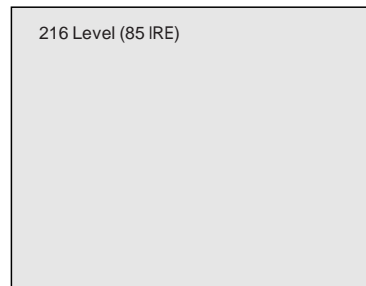

(Fig. 8) Position and Pattern for Manual Adjustment of White Balance

8. Auto Component Color Balance

8-1. Required Test Equipment

- 1) Remote controller for adjustment
- 2) 802F Pattern Generator
(Which has 720p Ypbpr output & PC 1024x768 60Hz with Standard(0.7Vpp) Vertical 100% Color Bar Pattern as Fig.8)

8-2. Method of Auto Component Color Balance

- 1) Input the Component 720p 100% Color Bar signal into Component1 or Component2.
- 2) Set the PSM to Standard mode in Picture menu.
- 3) Press INSTART key on R/C for adjustment.
- 4) Press the ►(Vol. +) key operate To set, then it becomes automatically.
- 5) Auto-RGB OK means complete adjustment

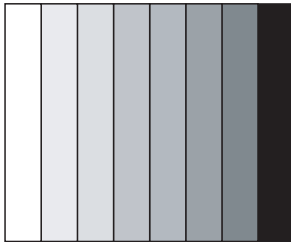

(Fig. 9) Auto Component Color Balance Test Pattern

9. Auto RGB Color Balance

9-1. Required Test Equipment

- 1) Remote controller for adjustment
- 2) 802F Pattern Generator, Master (MSPG-925FA), etc.
(Which has XGA 60Hz PC Format output with standard (0.7Vpp) horizontal black and white pattern as Fig.10)

9-2. Method of Auto RGB Color Balance

- 1) Input the PC 1024x768 60Hz horizontal black and white pattern into RGB.
- 2) Set the PSM to Standard mode in Picture menu.
- 3) Press ADJ key on R/C for adjustment.
- 4) Press the ►(Vol. +) key operate To set, then it becomes automatically.
- 5) Auto-RGB OK means completed adjustment.



(Fig. 10) Auto RGB Color Balance Test Pattern

10. Default Value in Adjustment mode

10-1. Auto Color Balance(Component/RGB)

Auto Color Balance(Hex)		
Auto-RGB	► To Set	
Red Offset1		22
Green Offset1		24
Blue Offset1		23
Red Offset2		45
Green Offset2		43
Blue Offset2		37
Red Gain		14
Green Gain		31
Blue Gain		11
Reset	► To Set	

(Fig. 11) Default Value on OSD

10-2. White Balance

White Balance(Hex)		
Red Gain		82
Red Offset		7A
Green Gain		86
Green Offset		7F
Blue Gain		7E
Blue Offset		80
Reset	► To Set	

(Fig. 12) Default Value on OSD

1-2. Sony Power Board Structure

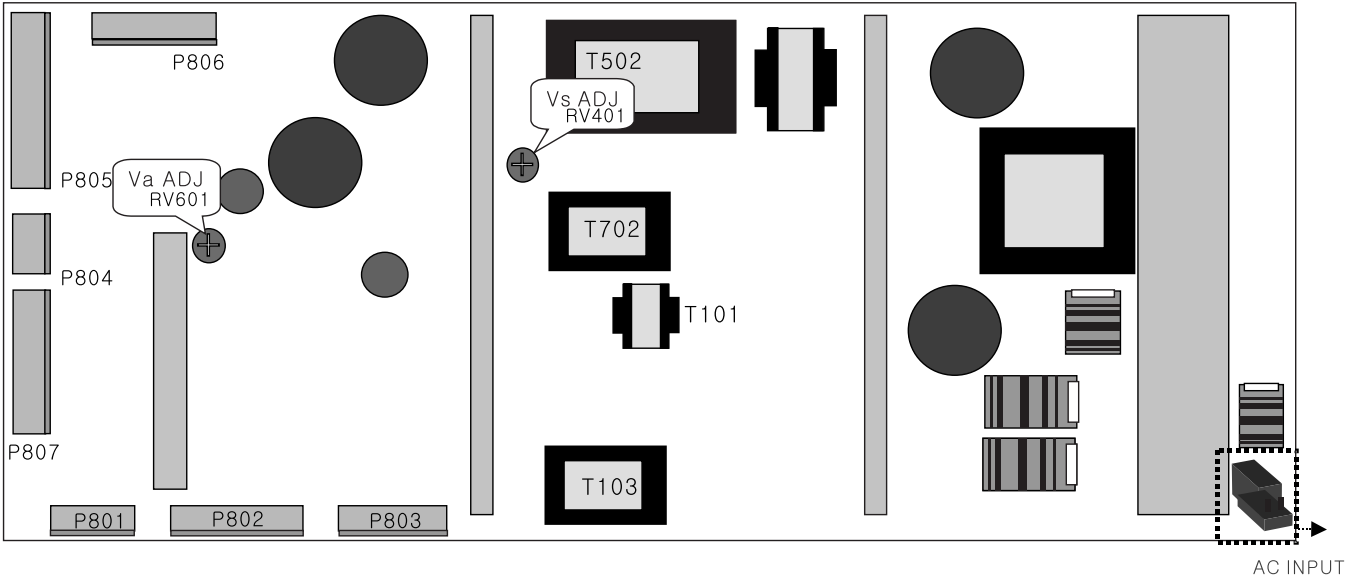

PIN No	1	2	3	4	5	6	7	8	9	10	11	12
P801	POD	5V-MNT	VS-ON	GND	STBY5V	RL-ON	A-ON					
P802	GND	GND	12V	12V	GND	GND	6V	6V	GND	GND	3.4V	3.4V
P803	GND	12V	GND	3.4V	GND	6V	GND	GND	25V	25V		
P804	GND	GND	5V	5V								
P805	Vs	Vs	Vs	NC	GND	GND	GND	GND	Va	Va		
P806	5V	GND	Va	GND	GND	NC	Vs	Vs				
P807	5V	5V	5V	5V	GND	GND	GND	GND				

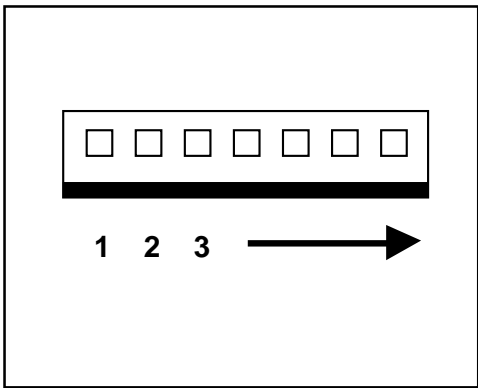

- T502: Vs Trans
- T702: Va Trans
- T101: St-by Trans
- T103: Low Voltage Trans

1-3. Sanken Power Board Structure

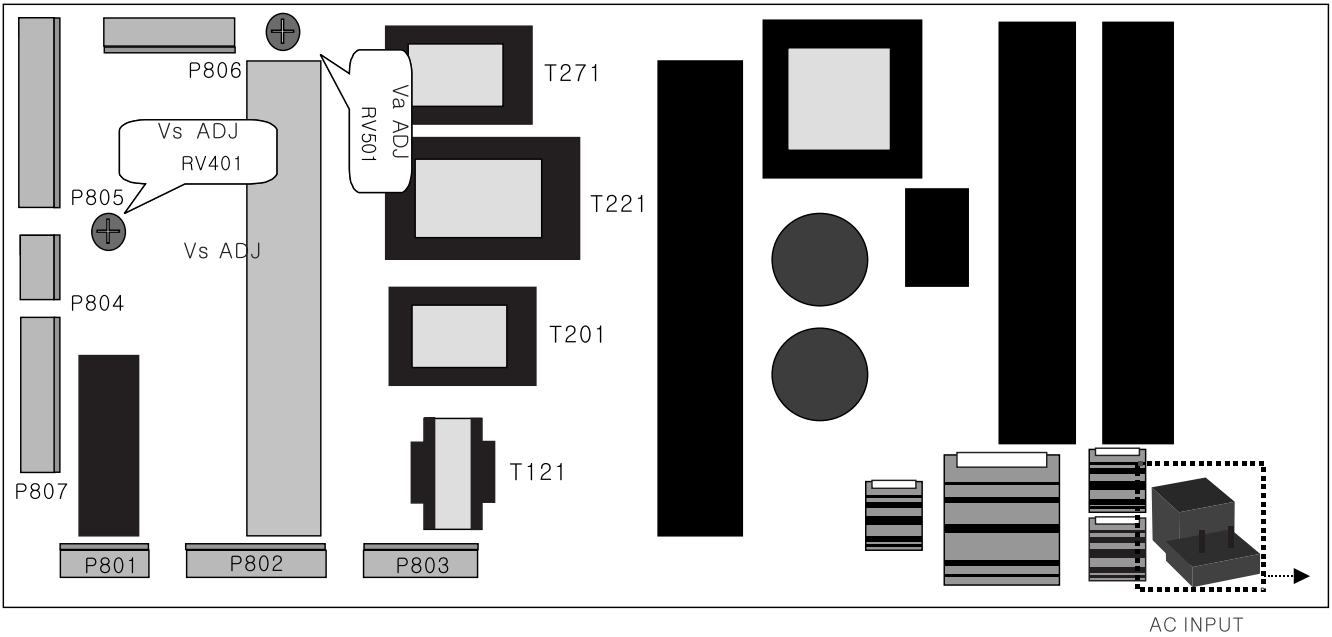

PIN No	1	2	3	4	5	6	7	8	9	10	11	12
P801	NC	5V-MNT	VS-ON	GND	STBY5V	RL-ON	A-ON					
P802	GND	GND	12V	12V	GND	GND	6V	6V	GND	GND	3.4V	3.4V
P803	GND	12V	GND	3.4V	GND	6V	GND	GND	19V	19V		
P804	GND	GND	5V	5V								
P805	Vs	Vs	Vs	NC	GND	GND	GND	GND	Va	Va		

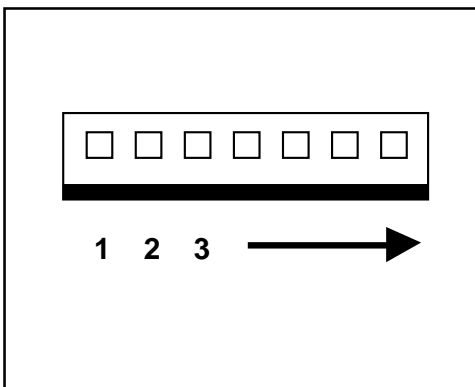

- T221: Vs Trans
- T271: Va Trans
- T121: St-by Trans
- T201: Low Voltage Trans

2. No Power

(1) Symptom

- Does't minute discharge at module.
- Non does not come in into the front LED.

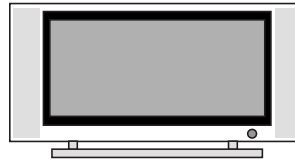

(2) Check follow

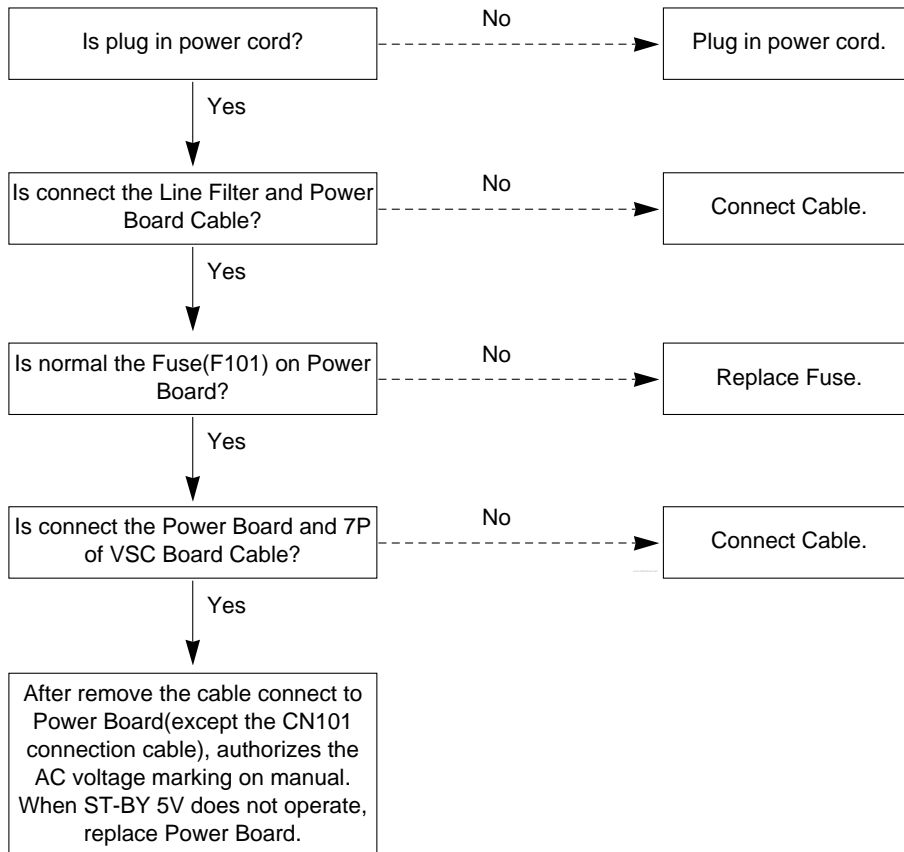

3. Protect Mode

(1) Symptom

- After once shining, it does not discharge minutely from module
- The Relay falls(The sound is audible “click”)
- It is converted with the color where the front LED is red from green.

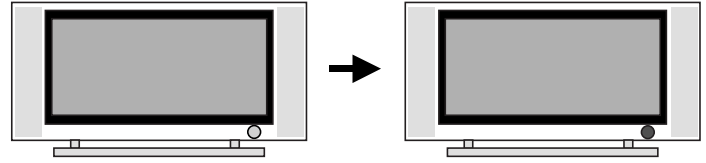

(2) Check follow

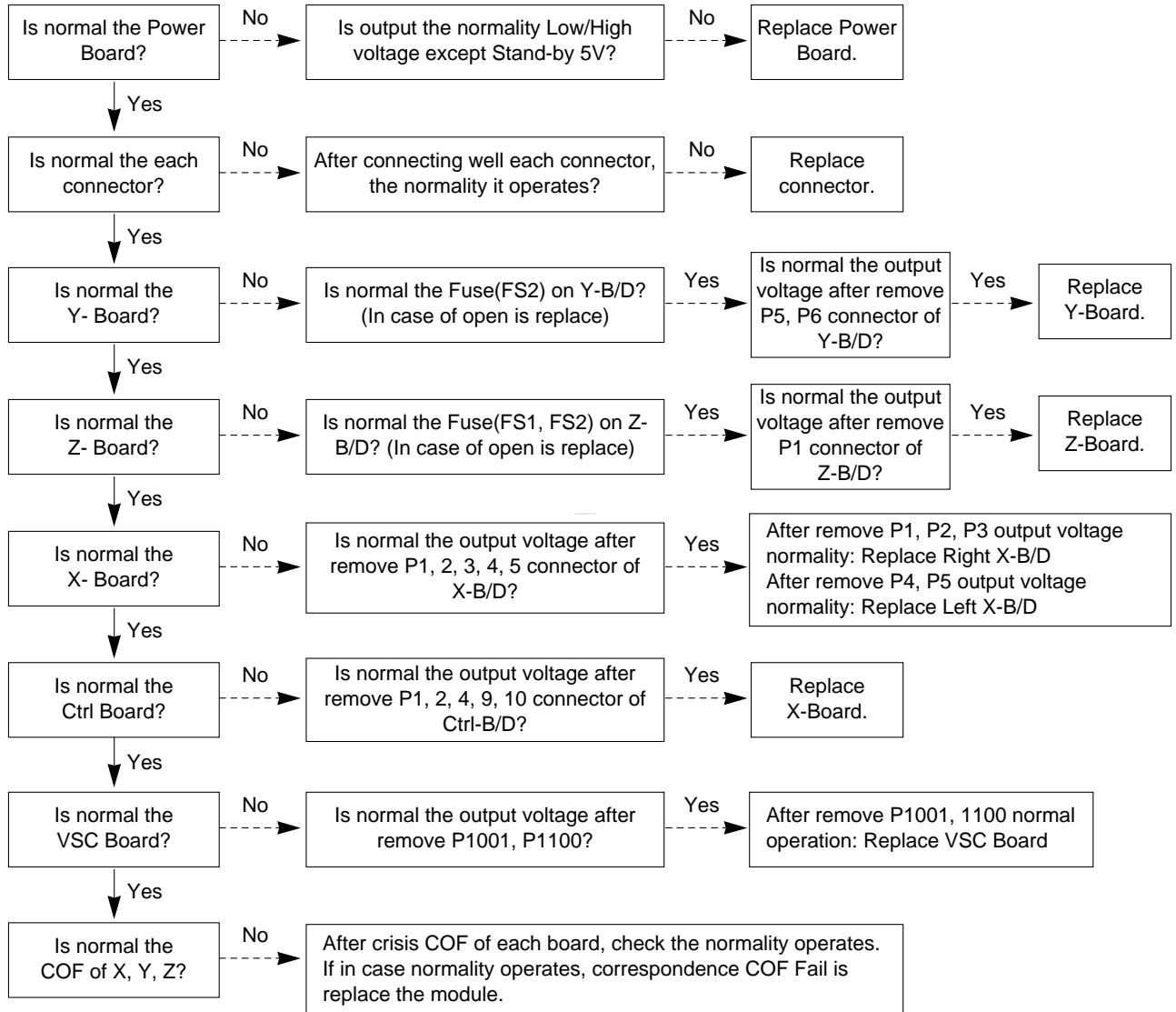

4. No Raster

(1) Symptom

- Does't minute discharge at module.
- It maintains the condition where the front LED is green.

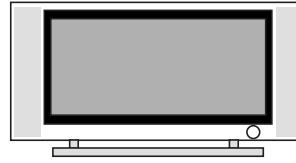

(2) Check follow

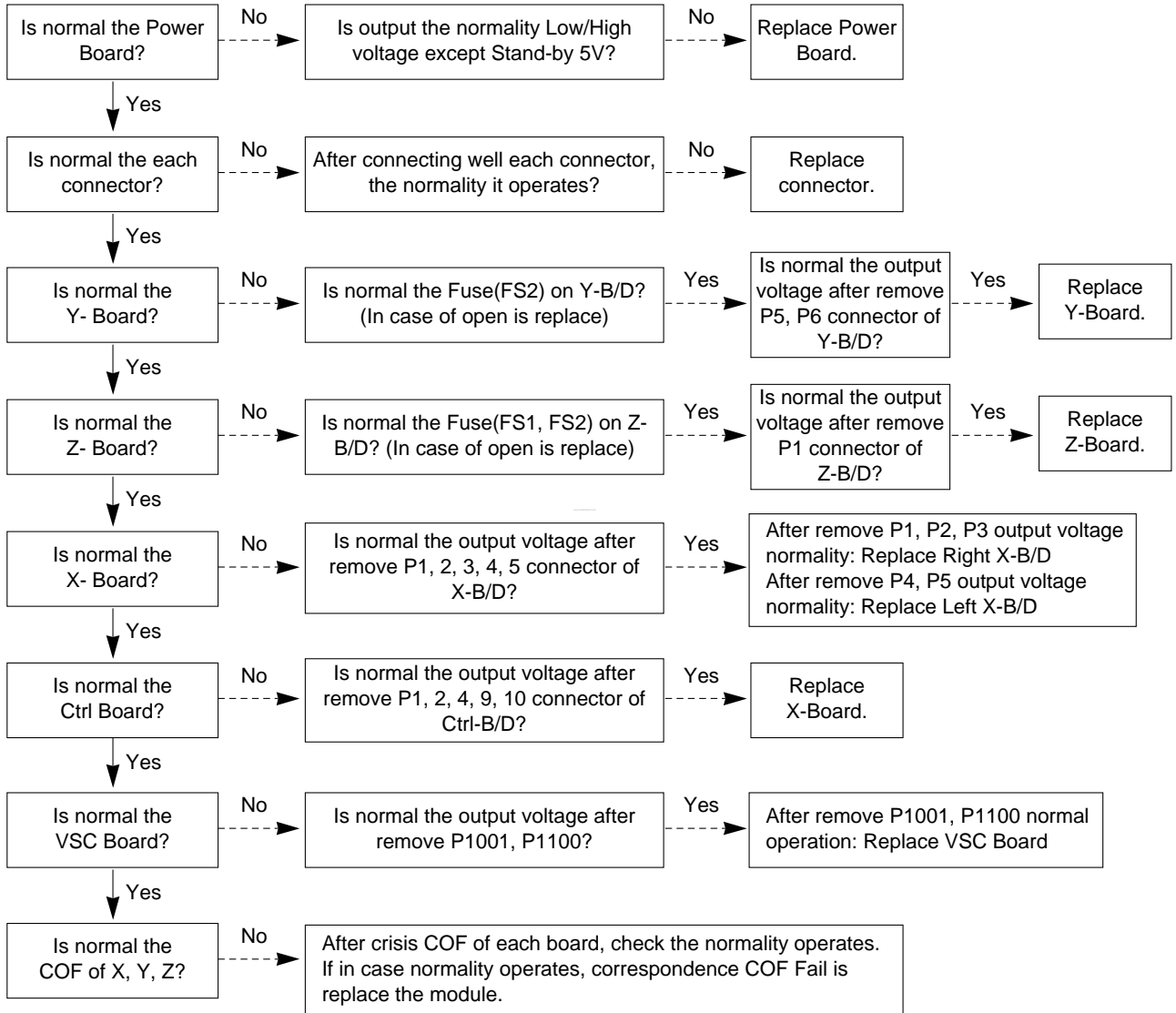

5. In case of occur strange screen into specific mode

5-1. In case of does't display the OSD

(1) Symptom

- LED is green
- The minute discharge continuously becomes accomplished from module

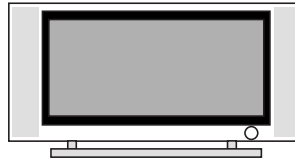

(2) Check follow

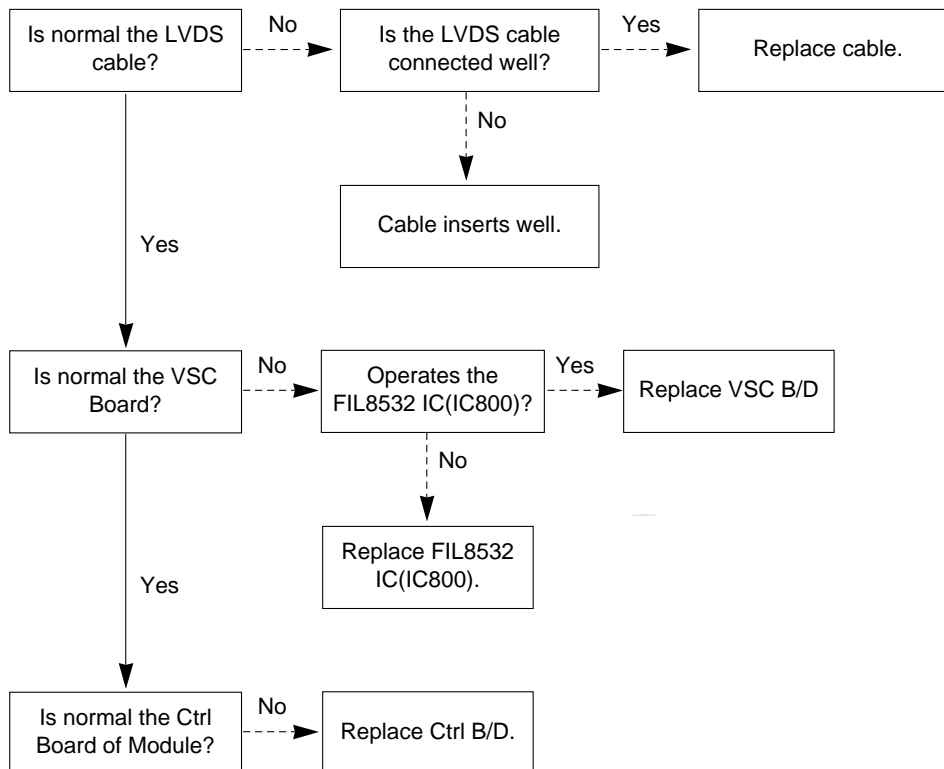

5-2. In case of does't display the screen into specific mode

(1) Symptom

- The screen does not become the display from specific input mode (RF, AV, Component, RGB, DVI).

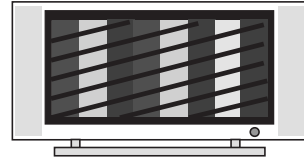

(2) Check follow

- Check the all input mode should become normality display.
- Check the Video(Main)/Data(Sub), Video(Main)/Video(Sub) should become normality display from the PIP mode or DW mode. (Re-Check it Swap)

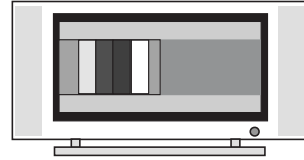

(3) In case of becomes unusual display from RF mode

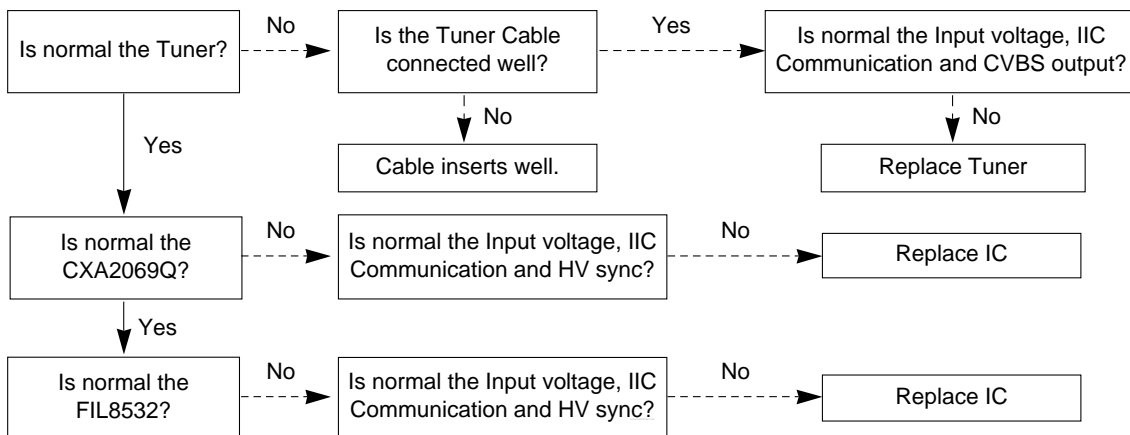

(4) In the case of becomes unusual display from RF, AV mode

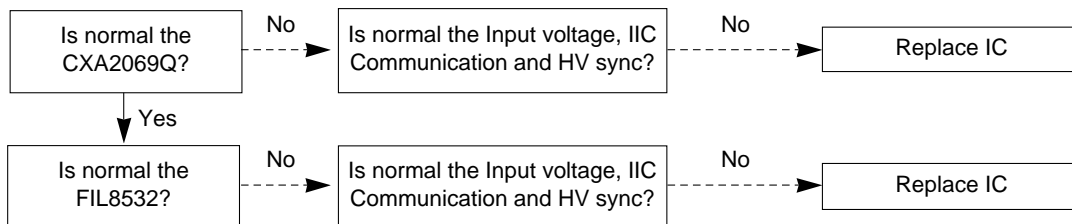

(5) In the case of becomes unusual display from Component, RGB mode

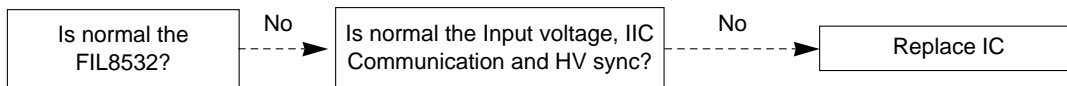

(6) In the case of becomes unusual display from HDMI mode

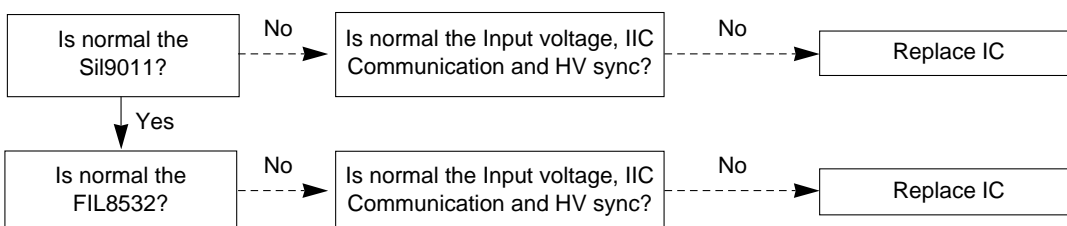

6. In case of no sound

(1) Symptom

- LED is green
- Screen display but sound is not output

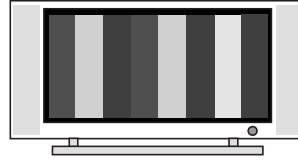

(2) Check follow

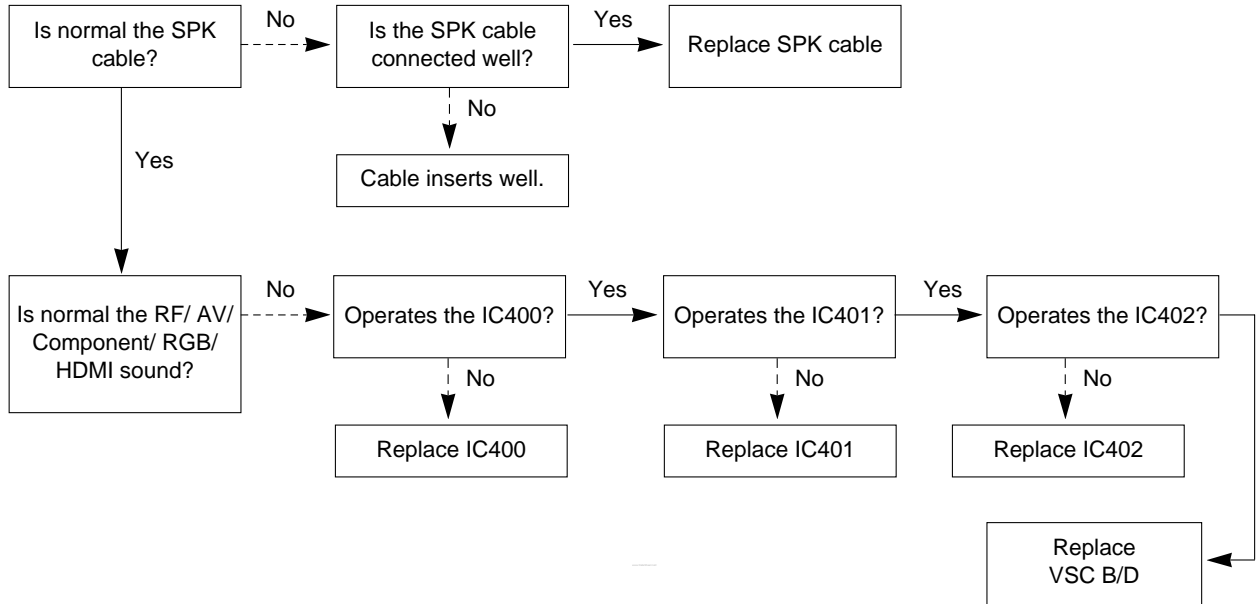

MEMO

EXPLODED VIEW

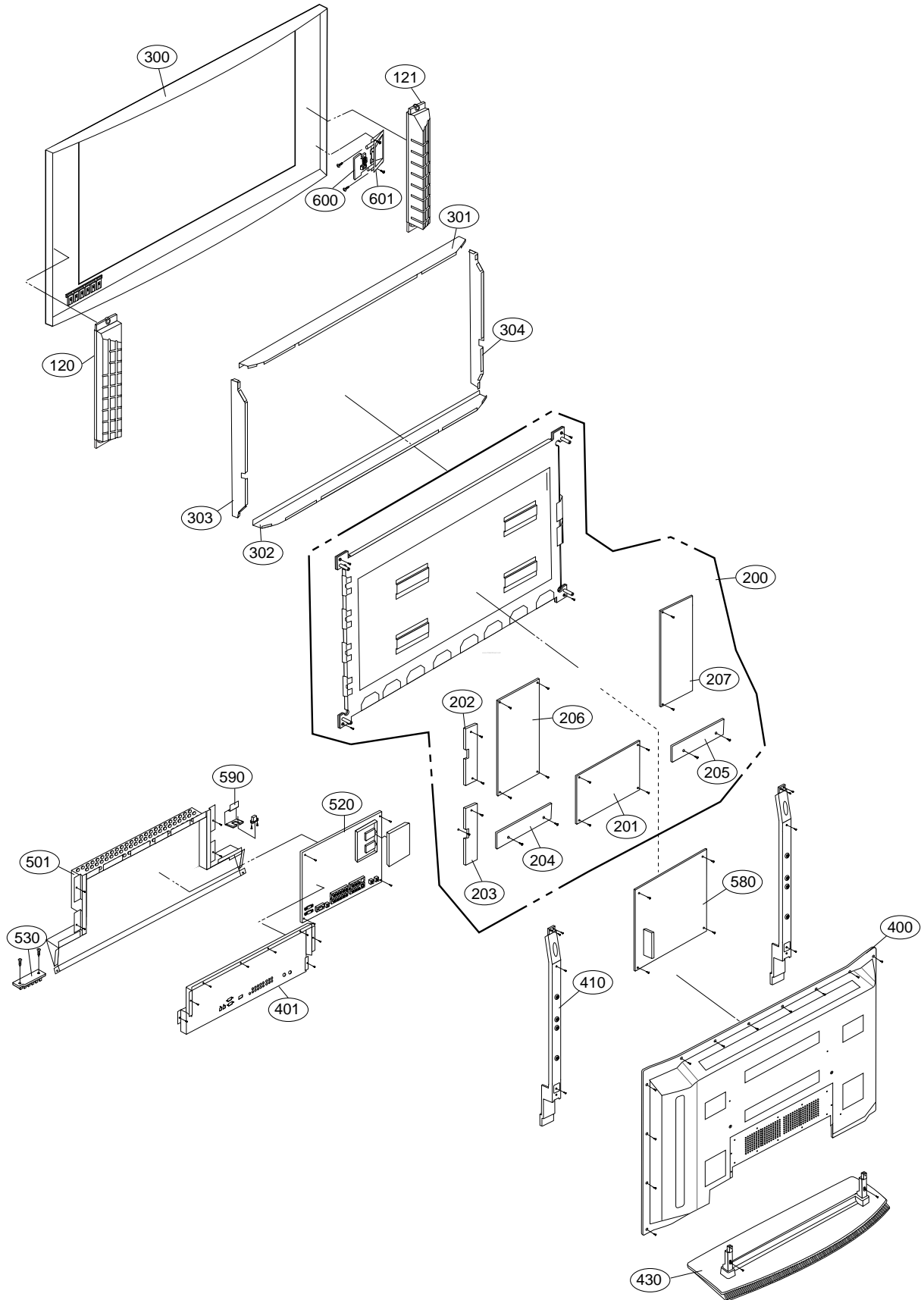

EXPLODED VIEW PARTS LIST

No.	Part No.	Descriptions
120	6401VD0032A	SPEAKER ASSEMBLY, FULL RANGE(R) RZ-42PX30 FILM TYPE
121	6401VD0033A	SPEAKER ASSEMBLY, FULL RANGE(L) RZ-42PX30 FILM TYPE
200	6348Q-E080W	PDP, 42" 852*480 PDP42V70102.ADLGB
201	6871QCH053A	PWB(PCB) ASSEMBLY,DISPLAY CTRL ASSY HAND INSERT 42V7 FPGA
202	6871QDH084A	PWB(PCB) ASSEMBLY,DISPLAY YDRV ASSY HAND INSERT 42V7 YDRV TOP B/D
203	6871QDH085A	PWB(PCB) ASSEMBLY,DISPLAY YDRV ASSY HAND INSERT 42V7 YDRV BTM B/D
204	6871QLH047A	PWB(PCB) ASSEMBLY,DISPLAY XRLT ASSY HAND INSERT 42V7 XL B/D
205	6871QRH055A	PWB(PCB) ASSEMBLY,DISPLAY XRRT ASSY HAND INSERT 42V7 XR B/D
206	6871QYH036A	PWB(PCB) ASSEMBLY,DISPLAY YSUS ASSY HAND INSERT 42V7
207	6871QZH041A	PWB(PCB) ASSEMBLY,DISPLAY ZSUS ASSY HAND INSERT 42V7 ZSUS HAND INSERT ASSY
300	3091V00816C	CABINET ASSEMBLY, RZ-42PX30 STEREO MF056C FILM TYPE SKD
301	4980V01203B	SUPPORTER, ASSY AL FILTER TOP RZ-42PX30 C/SKD
302	4980V01204B	SUPPORTER, ASSY AL FILTER BOTTOM RZ-42PX30 C/SKD
303	4980V01205B	SUPPORTER, ASSY AL FILTER RIGHT RZ-42PX30 C/SKD
304	4980V01206B	SUPPORTER, ASSY AL FILTER LEFT RZ-42PX30 C/SKD
400	3809V00605B	BACK COVER ASSEMBLY, 42PX17/30 CHASSIS CHANGE C/SKD
401	3301V00085A	PLATE ASSEMBLY, ASSY 3300V00552A RZ-42PX30 PLATE TUNER COVER
410	4980V01071B	SUPPORTER, ASSY AL VERTICAL RZ-42PX10 SKD
430	3501V00216E	BOARD ASSEMBLY, ASSY AP-42DX30 MF056C C/SKD
501	3301V00083A	PLATE ASSEMBLY, ASSY 3300V00550A 3301V00084A 42PX17/30 PLATE TUNER
520	6871VMMF61A	PWB(PCB) ASSEMBLY,MAIN MF-056C H2, RZ-42PX30
530	6871VSMS36B	PWB(PCB) ASSEMBLY,SUB CONT MF056C RZ-42PX30 SKD NO VINYL
580	6709V00010A	POWER SUPPLY ASSEMBLY, PDP 42INCH MF056A 350W YPSU-J006A LG INNOTEK PSU ASSY
600	6871VSMS18B	PWB(PCB) ASSEMBLY,SUB A/V MF056A RT/RZ-42PX40 SIDE A/V SUSAB
601	4811V00118A	BRACKET ASSEMBLY, DECO RZ-42PX10 RF043B SIDE AV

REPLACEMENT PARTS LIST

LOCA. NO	PART NO	DESCRIPTION	LOCA. NO	PART NO	DESCRIPTION
IC					
IC1000	0IPRPM001A	MIC39100 3P SOT223 R/TP LDO TYPE 2.5V	Q202	0TR387500AA	CHIP 2SC3875S(ALY) KEC
IC1001	0IMCRRH001A	BA033FP-E2 ROHM 3P-SOP,TO252-3 R/TP 3.3V	Q203	0TR150400BA	CHIP 2SA1504S(ASY) KEC
IC1002	0IMCRFA010A	KA7809R, FAIRCHILD 2P D-PAK, R/TP IC	Q204	0TR150400BA	CHIP 2SA1504S(ASY) KEC
IC1003	0IPMG00027A	SC156515M-1.8TR SEMTECH 5P/TO-263-5 R/TP	Q205	0TR387500AA	CHIP 2SC3875S(ALY) KEC
IC1004	0IMCRRH001A	BA033FP-E2 ROHM 3P-SOP,TO252-3 R/TP 3.3V	Q206	0TR150400BA	CHIP 2SA1504S(ASY) KEC
IC1005	0IMCRRH001A	BA033FP-E2 ROHM 3P-SOP,TO252-3 R/TP 3.3V	Q207	0TR150400BA	CHIP 2SA1504S(ASY) KEC
IC1100	0IMCRRH001A	BA033FP-E2 ROHM 3P-SOP,TO252-3 R/TP 3.3V	Q300	0TR387500AA	CHIP 2SC3875S(ALY) KEC
IC1101	0IPRPM001A	MIC39100 MICREL 3P SOT223 R/TP LDO TYPE	Q303	0TR387500AA	CHIP 2SC3875S(ALY) KEC
IC1102	0IPMG00027A	SC156515M-1.8TR SEMTECH 5P/TO-263-5	Q304	0TR387500AA	CHIP 2SC3875S(ALY) KEC
IC1103	0IPMGKE030A	KIA78R05F KEC 5PIN DPAK R/TP 1A,5V	Q305	0TR150400BA	CHIP 2SA1504S(ASY) KEC
IC1104	0IPMG00027A	SC156515M-1.8TR SEMTECH 5P/TO-263-5	Q400	0TR387500AA	CHIP 2SC3875S(ALY) KEC
IC1200	0IPRPS5005A	SII9011CLU(PB FREE) SILICON IMAGE 128P	Q401	0TR387500AA	CHIP 2SC3875S(ALY) KEC
IC1201	0IMMRAL014B	AT24C02N-10SI-2.7 ATMEL 8P SOIC R/TP	Q402	0TR387500AA	CHIP 2SC3875S(ALY) KEC
IC202	0IPMGON013B	MC34063ADR2G ON SEMI SO-8P R/TP	Q403	0TR387500AA	CHIP 2SC3875S(ALY) KEC
IC300	0ISO206900A	CXA2069Q QFP64 BK I2C BUS AV S/W	Q404	0TR387500AA	CHIP 2SC3875S(ALY) KEC
IC301	0ISA721700C	LA7217M MFP14 TP SYNC SEPARATOR ML-00BA	Q405	0TR102008AA	KRA102S R/TP KEC SOT23 CHIP TR
IC400	0IMCRMN028B	MSP4410K MICRONAS 80P/PQFP	Q406	0TR102008AA	KRA102S R/TP KEC SOT23 CHIP TR
IC401	0ILNR00015A	NSP-2100A,LF NEOFIDELITY TQFP 64P	Q407	0TR387500AA	CHIP 2SC3875S(ALY) KEC
IC402	0IMCRTI028C	TAS5122DCAR 56P/TSSOP R/TP 30W STEREO	Q408	0TR102008AA	KRA102S R/TP KEC SOT23 CHIP TR
IC403	0ISS455880A	KA4558D 8SOP OP AMP	Q409	0TR387500AA	CHIP 2SC3875S(ALY) KEC
IC404	0IPH741400E	74HC14D 14SOP TP SHITTER TRIGGER	Q410	0TR387500AA	CHIP 2SC3875S(ALY) KEC
IC500	0IMMRAL014B	AT24C02N-10SI-2.7 ATMEL 8P SOIC	Q411	0TR387500AA	CHIP 2SC3875S(ALY) KEC
IC502	0IPH741400E	74HC14D 14SOP TP SHITTER TRIGGER	DIODE		
IC600	0IPRP00009A	ICL3232CBNZ INTERSIL 16P/SOP R/TP	D1005	0DD226239AA	KDS226 TP KEC
IC800	0IMCR02005A	FLI8532BC-LF GENESIS 416P/PBGA	D1006	0DD226239AA	KDS226 TP KEC
IC802	0IMP242560A	24LC256-I/SM 8P,SOP TP 256K IIC SERIAL	D1007	0DD226239AA	KDS226 TP KEC
IC900	0IMMRAL016D	AT49BV160-70TI ATMEL 48P TSOP	D1008	0DD226239AA	KDS226 TP KEC
IC901	0IMMR00002A	K4D261638F-LC50,LF TSOPII 66P	D1009	0DD226239AA	KDS226 TP KEC
IC902	0IMMR00002A	K4D261638F-LC50,LF TSOPII 66P	D1010	0DD226239AA	KDS226 TP KEC
TRANSISTOR			D1012	0DD200009AF	RU2M V(1) TP SANKEN
IC1202	0TR830009BA	BSS83 TP PHILIPS N-CHANNEL S/W TR	D1013	0DD200009AF	RU2M V(1) TP SANKEN
IC1203	0TR830009BA	BSS83 TP PHILIPS N-CHANNEL S/W TR	D102	0DD226239AA	KDS226 TP KEC
IC200	0TR830009BA	BSS83 TP PHILIPS N-CHANNEL S/W TR	D103	0DD226239AA	KDS226 TP KEC
IC201	0TR830009BA	BSS83 TP PHILIPS N-CHANNEL S/W TR	D104	0DD226239AA	KDS226 TP KEC
IC503	0TR830009BA	BSS83 TP PHILIPS N-CHANNEL S/W TR	D105	0DD226239AA	KDS226 TP KEC
IC504	0TR830009BA	BSS83 TP PHILIPS N-CHANNEL S/W TR	D106	0DD226239AA	KDS226 TP KEC
Q100	0TR387500AA	CHIP 2SC3875S(ALY) KEC	D108	0DD226239AA	KDS226 TP KEC
Q1000	0TR387500AA	CHIP 2SC3875S(ALY) KEC	D1100	0DD226239AA	KDS226 TP KEC
Q1001	0TR387500AA	CHIP 2SC3875S(ALY) KEC	D1105	0DD226239AA	KDS226 TP KEC
Q1002	0TR387500AA	CHIP 2SC3875S(ALY) KEC	D1109	0DD226239AA	KDS226 TP KEC
Q1003	0TR387500AA	CHIP 2SC3875S(ALY) KEC	D112	0DD226239AA	KDS226 TP KEC
Q1004	0TR387500AA	CHIP 2SC3875S(ALY) KEC	D113	0DD226239AA	KDS226 TP KEC
Q101	0TR387500AA	CHIP 2SC3875S(ALY) KEC	D114	0DD226239AA	KDS226 TP KEC
Q101	0TR387500AA	CHIP 2SC3875S(ALY) KEC	D1200	0DD184009AA	KDS184 TP KEC - 85V - 300MA
Q102	0TR102008AA	KRA102S R/TP KEC SOT23 CHIP TR	D1201	0DS113379BA	1SS133 T-72 TP ROHM KOREA DO34 90V
Q102	0TR387500AA	CHIP 2SC3875S(ALY) KEC	D300	0DD226239AA	KDS226 TP KEC
Q103	0TR387500AA	CHIP 2SC3875S(ALY) KEC	D500	0DD226239AA	KDS226 TP KEC
Q104	0TR387500AA	CHIP 2SC3875S(ALY) KEC	D501	0DD226239AA	KDS226 TP KEC
Q1200	0TR387500AA	CHIP 2SC3875S(ALY) KEC	D502	0DD226239AA	KDS226 TP KEC
Q201	0TR387500AA	CHIP 2SC3875S(ALY) KEC	D504	0DR050008AA	SD05.TC R/TP SEMTECH SOD323 5V 5A 15A
			D505	0DR050008AA	SD05.TC R/TP SEMTECH SOD323 5V 5A 15A
			D506	0DR050008AA	SD05.TC R/TP SEMTECH SOD323 5V 5A 15A

For Capacitor & Resistors, the characters at 2nd and 3rd digit in the P/No. means as follows;

CC, CX, CK, CN : Ceramic
CQ : Polyester
CE : Electrolytic

RD : Carbon Film
RS : Metal Oxide Film
RN : Metal Film
RF : Fusible

LOCA. NO	PART NO	DESCRIPTION
ZD100	0DR050008AA	SD05.TC R/TP SEMTECH SOD323 5V 5A 15A
ZD101	0DR050008AA	SD05.TC R/TP SEMTECH SOD323 5V 5A 15A
ZD107	0DR050008AA	SD05.TC R/TP SEMTECH SOD323 5V 5A 15A
ZD300	0DR050008AA	SD05.TC R/TP SEMTECH SOD323 5V 5A 15A
ZD301	0DR050008AA	SD05.TC R/TP SEMTECH SOD323 5V 5A 15A
ZD400	0DZRM00248A	RLZ8.2B-TE11 ROHM R/TP LLDS(LL-34)
ZD600	0DR050008AA	SD05.TC R/TP SEMTECH SOD323 5V 5A 15A

CAPACITOR

C1000	0CE477SF6DC	470UF MVG 16V 20% R/TP(SMD) SMD
C1005	0CE477SF6DC	470UF MVG 16V 20% R/TP(SMD) SMD
C1007	0CE107SF6DC	100UF MVG 16V 20% SMD R/TP
C1009	0CE107SF6DC	100UF MVG 16V 20% SMD R/TP
C1010	0CE107SF6DC	100UF MVG 16V 20% SMD R/TP
C1019	0CE476SF6DC	47UF MVG 16V 20% SMD R/TP
C1022	0CE107SF6DC	100UF MVG 16V 20% SMD R/TP
C103	0CE4763F618	47UF SRE 16V M FL TP5
C1030	0CE476SF6DC	47UF MVG 16V 20% SMD R/TP
C1043	0CE476SF6DC	47UF MVG 16V 20% SMD R/TP
C1046	0CE477SF6DC	470UF MVG 16V 20% R/TP(SMD) SMD
C1047	0CE476SF6DC	47UF MVG 16V 20% SMD R/TP
C1050	0CE477SF6DC	470UF MVG 16V 20% R/TP(SMD) SMD
C1051	0CE477SF6DC	470UF MVG 16V 20% R/TP(SMD) SMD
C1064	0CE476SF6DC	47UF MVG 16V 20% SMD R/TP
C1065	0CE476SF6DC	47UF MVG 16V 20% SMD R/TP
C1066	0CE476SF6DC	47UF MVG 16V 20% SMD R/TP
C1067	0CE476SF6DC	47UF MVG 16V 20% SMD R/TP
C1068	0CE476SF6DC	47UF MVG 16V 20% SMD R/TP
C1069	0CE476SF6DC	47UF MVG 16V 20% SMD R/TP
C1071	0CE477SF6DC	470UF MVG 16V 20% R/TP(SMD) SMD
C1073	0CE477SF6DC	470UF MVG 16V 20% R/TP(SMD) SMD
C108	0CE227SF6DC	220UF MVG 16V 20% R/TP(SMD) SMD
C1082	0CE476SF6DC	47UF MVG 16V 20% SMD R/TP
C1083	0CE476SF6DC	47UF MVG 16V 20% SMD R/TP
C1084	0CE476SF6DC	47UF MVG 16V 20% SMD R/TP
C1085	0CE476SF6DC	47UF MVG 16V 20% SMD R/TP
C1087	0CE477SF6DC	470UF MVG 16V 20% R/TP(SMD) SMD
C1098	0CE476SF6DC	47UF MVG 16V 20% SMD R/TP
C1099	0CE476SF6DC	47UF MVG 16V 20% SMD R/TP
C1102	0CE476SF6DC	47UF MVG 16V 20% SMD R/TP
C1105	0CE476SF6DC	47UF MVG 16V 20% SMD R/TP
C1107	0CE107SF6DC	100UF MVG 16V 20% SMD R/TP
C1108	0CE107SF6DC	100UF MVG 16V 20% SMD R/TP
C1110	0CE477SF6DC	470UF MVG 16V 20% R/TP(SMD) SMD
C1115	0CE477DJ618	470UF STD 35V 20% FL TP 5
C1116	0CE477SF6DC	470UF MVG 16V 20% R/TP(SMD) SMD
C1117	0CE227SF6DC	220UF MVG 16V 20% R/TP(SMD) SMD
C1117	0CE227VF6DC	220UF MV 16V 20% R/TP(SMD) SMD
C1118	0CE477SF6DC	470UF MVG 16V 20% R/TP(SMD) SMD
C1119	0CE477DJ618	470UF STD 35V 20% FL TP 5
C1120	0CE227VF6DC	220UF MV 16V 20% R/TP(SMD) SMD
C1126	0CE477SF6DC	470UF MVG 16V 20% R/TP(SMD) SMD

LOCA. NO	PART NO	DESCRIPTION
C1135	0CE107SF6DC	100UF MVG 16V 20% SMD R/TP
C1136	0CE107SF6DC	100UF MVG 16V 20% SMD R/TP
C1137	0CE107SF6DC	100UF MVG 16V 20% SMD R/TP
C1138	0CE107SF6DC	100UF MVG 16V 20% SMD R/TP
C1148	0CE476SF6DC	47UF MVG 16V 20% SMD R/TP
C1154	0CE476SF6DC	47UF MVG 16V 20% SMD R/TP
C117	0CE227SF6DC	220UF MVG 16V 20% R/TP(SMD) SMD
C118	0CE106SF6DC	10UF MVG 16V 20% R/TP(SMD) SMD
C1185	0CE476SF6DC	47UF MVG 16V 20% SMD R/TP
C119	0CE106SF6DC	10UF MVG 16V 20% R/TP(SMD) SMD
C1199	0CE107SF6DC	100UF MVG 16V 20% SMD R/TP
C120	0CE106SF6DC	10UF MVG 16V 20% R/TP(SMD) SMD
C1200	0CE106SF6DC	10UF MVG 16V 20% R/TP(SMD) SMD
C1201	0CE106SF6DC	10UF MVG 16V 20% R/TP(SMD) SMD
C121	0CE106SF6DC	10UF MVG 16V 20% R/TP(SMD) SMD
C1225	0CE106SF6DC	10UF MVG 16V 20% R/TP(SMD) SMD
C1230	0CK105DF64A	1UF 2012 16V 20% R/TP F(Y5V)
C1231	0CK105DF64A	1UF 2012 16V 20% R/TP F(Y5V)
C1245	0CE106SF6DC	10UF MVG 16V 20% R/TP(SMD) SMD
C1247	0CE476SF6DC	47UF MVG 16V 20% SMD R/TP
C129	0CE227SF6DC	220UF MVG 16V 20% R/TP(SMD) SMD
C130	0CE227SF6DC	220UF MVG 16V 20% R/TP(SMD) SMD
C130	0CE227VF6DC	220UF MV 16V 20% R/TP(SMD) SMD
C131	0CE476SF6DC	47UF MVG 16V 20% SMD R/TP
C1311	0CE107SF6DC	100UF MVG 16V 20% SMD R/TP
C1312	0CE107SF6DC	100UF MVG 16V 20% SMD R/TP
C1314	0CE107SF6DC	100UF MVG 16V 20% SMD R/TP
C1315	0CE107SF6DC	100UF MVG 16V 20% SMD R/TP
C1316	0CE476SF6DC	47UF MVG 16V 20% SMD R/TP
C1317	0CE476SF6DC	47UF MVG 16V 20% SMD R/TP
C1318	0CE476SF6DC	47UF MVG 16V 20% SMD R/TP
C135	0CE476SF6DC	47UF MVG 16V 20% SMD R/TP
C1406	0CE106SF6DC	10UF MVG 16V 20% R/TP(SMD) SMD
C1414	0CE475SK6DC	4.7UF MVG 50V 20% SMD R/TP
C1415	0CE475SK6DC	4.7UF MVG 50V 20% SMD R/TP
C1419	0CE106SF6DC	10UF MVG 16V 20% R/TP(SMD) SMD
C1420	0CK105DF64A	1UF 2012 16V 20% R/TP F(Y5V)
C1424	0CE106SF6DC	10UF MVG 16V 20% R/TP(SMD) SMD
C1425	0CE106SH6DC	10UF MVG 25V 20% SMD R/TP
C1428	0CE106SH6DC	10UF MVG 25V 20% SMD R/TP
C1438	0CE106SH6DC	10UF MVG 25V 20% SMD R/TP
C1441	0CE106SH6DC	10UF MVG 25V 20% SMD R/TP
C1506	0CE476SF6DC	47UF MVG 16V 20% SMD R/TP
C204	0CE477SF6DC	470UF MVG 16V 20% R/TP(SMD) SMD
C210	0CE475SK6DC	4.7UF MVG 50V 20% SMD R/TP
C211	0CE477SF6DC	470UF MVG 16V 20% R/TP(SMD) SMD
C214	0CE106SF6DC	10UF MVG 16V 20% R/TP(SMD) SMD
C215	0CE475SK6DC	4.7UF MVG 50V 20% SMD R/TP
C221	0CE477SF6DC	470UF MVG 16V 20% R/TP(SMD) SMD
C238	0CE107SF6DC	100UF MVG 16V 20% SMD R/TP
C241	0CE476SK6D8	47UF MVG,MC 50V 20% SMD TAPPING
C300	0CE107SF6DC	100UF MVG 16V 20% SMD R/TP

For Capacitor & Resistors, the characters at 2nd and 3rd digit in the P/No. means as follows;	CC, CX, CK, CN : Ceramic	RD : Carbon Film
	CQ : Polyester	RS : Metal Oxide Film
	CE : Electrolytic	RN : Metal Film
		RF : Fusible

LOCA. NO	PART NO	DESCRIPTION
C304	0CE226SF6DC	22UF MVG 16V 20% SMD R/TP
C305	0CE107SF6DC	100UF MVG 16V 20% SMD R/TP
C307	0CE476SF6DC	47UF MVG 16V 20% SMD R/TP
C310	0CK225DFK4A	2.2UF 2012 16V 20%,-20% F(Y5V) R/TP
C315	0CK225DFK4A	2.2UF 2012 16V 20%,-20% F(Y5V) R/TP
C318	0CK225DFK4A	2.2UF 2012 16V 20%,-20% F(Y5V) R/TP
C319	0CK225DFK4A	2.2UF 2012 16V 20%,-20% F(Y5V) R/TP
C321	0CK225DFK4A	2.2UF 2012 16V 20%,-20% F(Y5V) R/TP
C325	0CK225DFK4A	2.2UF 2012 16V 20%,-20% F(Y5V) R/TP
C328	0CK225DFK4A	2.2UF 2012 16V 20%,-20% F(Y5V) R/TP
C330	0CK225DFK4A	2.2UF 2012 16V 20%,-20% F(Y5V) R/TP
C338	0CK225DFK4A	2.2UF 2012 16V 20%,-20% F(Y5V) R/TP
C340	0CE476SF6DC	47UF MVG 16V 20% SMD R/TP
C342	0CE105SK6DC	1UF MVG 50V 20% SMD R/TP
C347	0CE105SK6DC	1UF MVG 50V 20% SMD R/TP
C402	0CE476SF6DC	47UF MVG 16V 20% SMD R/TP
C403	0CE226SF6DC	22UF MVG 16V 20% SMD R/TP
C413	0CE335VK6DC	3.3UF MV 50V 20% R/TP(SMD) SMD
C418	0CE107SF6DC	100UF MVG 16V 20% SMD R/TP
C422	0CE106SF6DC	10UF MVG 16V 20% R/TP(SMD) SMD
C425	0CE226SF6DC	22UF MVG 16V 20% SMD R/TP
C437	0CE106SF6DC	10UF MVG 16V 20% R/TP(SMD) SMD
C444	0CE107SF6DC	100UF MVG 16V 20% SMD R/TP
C451	0CK105DF64A	1UF 2012 16V 20% R/TP F(Y5V)
C456	0CK105DF64A	1UF 2012 16V 20% R/TP F(Y5V)
C457	0CE335VK6DC	3.3UF MV 50V 20% R/TP(SMD) SMD
C462	0CE107SF6DC	100UF MVG 16V 20% SMD R/TP
C463	0CE106SF6DC	10UF MVG 16V 20% R/TP(SMD) SMD
C464	0CE106SF6DC	10UF MVG 16V 20% R/TP(SMD) SMD
C465	0CE106SK6DC	10UF MVG 50V 20% SMD R/TP
C480	0CE108DJ618	1000UF STD 35V 20% FL TP 5
C481	0CE475SK6DC	4.7UF MVG 50V 20% SMD R/TP
C482	0CE475SK6DC	4.7UF MVG 50V 20% SMD R/TP
C483	0CF4741L438	0.47UF D 63V 5% TP 5 M/PE NI
C484	0CF4741L438	0.47UF D 63V 5% TP 5 M/PE NI
C495	0CE108DJ618	1000UF STD 35V 20% FL TP 5
C527	0CE476SF6DC	47UF MVG 16V 20% SMD R/TP
C610	0CE107SF6DC	100UF MVG 16V 20% SMD R/TP
C832	0CE226SF6DC	22UF MVG 16V 20% SMD R/TP
C833	0CE226SF6DC	22UF MVG 16V 20% SMD R/TP
C834	0CE226SF6DC	22UF MVG 16V 20% SMD R/TP
C835	0CE226SF6DC	22UF MVG 16V 20% SMD R/TP
C836	0CE226SF6DC	22UF MVG 16V 20% SMD R/TP
C837	0CE226SF6DC	22UF MVG 16V 20% SMD R/TP
C838	0CE226SF6DC	22UF MVG 16V 20% SMD R/TP
C839	0CE226SF6DC	22UF MVG 16V 20% SMD R/TP
C840	0CE226SF6DC	22UF MVG 16V 20% SMD R/TP
C851	0CE226SF6DC	22UF MVG 16V 20% SMD R/TP
C853	0CE226SF6DC	22UF MVG 16V 20% SMD R/TP
C884	0CE226SF6DC	22UF MVG 16V 20% SMD R/TP
C896	0CE226SF6DC	22UF MVG 16V 20% SMD R/TP
C901	0CE226SF6DC	22UF MVG 16V 20% SMD R/TP

LOCA. NO	PART NO	DESCRIPTION
C904	0CE226SF6DC	22UF MVG 16V 20% SMD R/TP
C905	0CE226SF6DC	22UF MVG 16V 20% SMD R/TP
C930	0CE226SF6DC	22UF MVG 16V 20% SMD R/TP
C950	0CE226SF6DC	22UF MVG 16V 20% SMD R/TP
COIL		
L1000	6140VB0004B	26UH 1UEWPHY 22.5TURN YL-9N 0.4
L1101	6140VB0004B	26UH 1UEWPHY 22.5TURN YL-9N 0.4
L1102	6140VB0004B	26UH 1UEWPHY 22.5TURN YL-9N 0.4
L1103	6140VB0004B	26UH 1UEWPHY 22.5TURN YL-9N 0.4
L1104	6140VB0004B	26UH 1UEWPHY 22.5TURN YL-9N 0.4
L404	6140VB0032A	DBF-1015A 15.5UH 10PIE DIGITAL AUDIO
L405	6140VB0032A	DBF-1015A 15.5UH 10PIE DIGITAL AUDIO
L406	6140VB0032A	DBF-1015A 15.5UH 10PIE DIGITAL AUDIO
L407	6140VB0032A	DBF-1015A 15.5UH 10PIE DIGITAL AUDIO
RESISTOR		
AR1200	0RRZVTA001D	22 OHM 1 / 16 W 1608 5% R/TP 4P
AR1201	0RRZVTA001D	22 OHM 1 / 16 W 1608 5% R/TP 4P
AR1202	0RRZVTA001D	22 OHM 1 / 16 W 1608 5% R/TP 4P
AR1203	0RRZVTA001D	22 OHM 1 / 16 W 1608 5% R/TP 4P
AR1204	0RRZVTA001D	22 OHM 1 / 16 W 1608 5% R/TP 4P
AR1205	0RRZVTA001D	22 OHM 1 / 16 W 1608 5% R/TP 4P
AR806	0RRZVTA001B	MNR14-E0A-J-510 R OHM 51 OHM 5%
AR807	0RRZVTA001B	MNR14-E0A-J-510 R OHM 51 OHM 5%
AR808	0RRZVTA001B	MNR14-E0A-J-510 R OHM 51 OHM 5%
AR809	0RRZVTA001B	MNR14-E0A-J-510 R OHM 51 OHM 5%
AR810	0RRZVTA001B	MNR14-E0A-J-510 R OHM 51 OHM 5%
AR811	0RRZVTA001B	MNR14-E0A-J-510 R OHM 51 OHM 5%
AR812	0RRZVTA001B	MNR14-E0A-J-510 R OHM 51 OHM 5%
AR813	0RRZVTA001B	MNR14-E0A-J-510 R OHM 51 OHM 5%
AR814	0RRZVTA001B	MNR14-E0A-J-510 R OHM 51 OHM 5%
AR815	0RRZVTA001B	MNR14-E0A-J-510 R OHM 51 OHM 5%
AR816	0RRZVTA001B	MNR14-E0A-J-510 R OHM 51 OHM 5%
AR817	0RRZVTA001B	MNR14-E0A-J-510 R OHM 51 OHM 5%
R230	0RD0331H609	3.3 OHM 1/2 W 5.00% TA52
LED		
D1003	0DL233309AC	SAM2333 GREEN/RED GREEN:10MCD, RED:6MCD
D1103	0DL233309AC	SAM2333 GREEN/RED GREEN:10MCD, RED:6MCD
LD101	0DL200000CA	SAM5670(DL-2LRG) BK Y-GREEN -
SWITCH		
SW101	140-315A	TACT SKHV17910B LG C&D 12V
SW102	140-315A	TACT SKHV17910B LG C&D 12V
SW103	140-315A	TACT SKHV17910B LG C&D 12V
SW104	140-315A	TACT SKHV17910B LG C&D 12V
SW105	140-315A	TACT SKHV17910B LG C&D 12V
SW106	140-315A	TACT SKHV17910B LG C&D 12V
SW107	140-315A	TACT SKHV17910B LG C&D 12V
SW108	140-315A	TACT SKHV17910B LG C&D 12V
SW800	6600VR1004A	SKHMPW 5P CHIP TACT J-ALPS

LOCA. NO	PART NO	DESCRIPTION
FILTER & CRYSTAL		
L100	6200J000013	MLB-321611-0500P-N2 MAG LAYERS
L1004	6200J000013	MLB-321611-0500P-N2 MAG LAYERS
L1005	6200J000013	MLB-321611-0500P-N2 MAG LAYERS
L1006	6200J000013	MLB-321611-0500P-N2 MAG LAYERS
L1007	6200J000013	MLB-321611-0500P-N2 MAG LAYERS
L1009	6200J000013	MLB-321611-0500P-N2 MAG LAYERS
L101	6200J000013	MLB-321611-0500P-N2 MAG LAYERS
L1010	6200J000013	MLB-321611-0500P-N2 MAG LAYERS
L1011	6200J000013	MLB-321611-0500P-N2 MAG LAYERS
L1012	6200J000013	MLB-321611-0500P-N2 MAG LAYERS
L1013	6200J000013	MLB-321611-0500P-N2 MAG LAYERS
L1014	6200J000013	MLB-321611-0500P-N2 MAG LAYERS
L1015	6200J000013	MLB-321611-0500P-N2 MAG LAYERS
L1016	6200J000013	MLB-321611-0500P-N2 MAG LAYERS
L1017	6200J000013	MLB-321611-0500P-N2 MAG LAYERS
L1018	6200J000013	MLB-321611-0500P-N2 MAG LAYERS
L1019	6200J000013	MLB-321611-0500P-N2 MAG LAYERS
L1020	6200J000013	MLB-321611-0500P-N2 MAG LAYERS
L1021	6200J000013	MLB-321611-0500P-N2 MAG LAYERS
L1022	6200J000013	MLB-321611-0500P-N2 MAG LAYERS
L1023	6200J000013	MLB-321611-0500P-N2 MAG LAYERS
L1024	6200J000013	MLB-321611-0500P-N2 MAG LAYERS
L1025	6200J000013	MLB-321611-0500P-N2 MAG LAYERS
L110	6200J000013	MLB-321611-0500P-N2 MAG LAYERS
L1105	6200J000013	MLB-321611-0500P-N2 MAG LAYERS
L1106	6200J000013	MLB-321611-0500P-N2 MAG LAYERS
L1107	6200J000013	MLB-321611-0500P-N2 MAG LAYERS
L1108	6200J000013	MLB-321611-0500P-N2 MAG LAYERS
L111	6200J000013	MLB-321611-0500P-N2 MAG LAYERS
L1125	6200J000013	MLB-321611-0500P-N2 MAG LAYERS
L1126	6200J000013	MLB-321611-0500P-N2 MAG LAYERS
L1127	6200J000013	MLB-321611-0500P-N2 MAG LAYERS
L1128	6200J000013	MLB-321611-0500P-N2 MAG LAYERS
L1129	6200J000013	MLB-321611-0500P-N2 MAG LAYERS
L1130	6200J000013	MLB-321611-0500P-N2 MAG LAYERS
L114	6200JB8010L	MLB-201209-1000L-N2 MAG LAYERS
L115	6200JB8010L	MLB-201209-1000L-N2 MAG LAYERS
L119	6200JB8010L	MLB-201209-1000L-N2 MAG LAYERS
L120	6200JB8010L	MLB-201209-1000L-N2 MAG LAYERS
L1204	6200J000013	MLB-321611-0500P-N2 MAG LAYERS
L1205	6200J000013	MLB-321611-0500P-N2 MAG LAYERS
L1206	6200J000013	MLB-321611-0500P-N2 MAG LAYERS
L1207	6200J000013	MLB-321611-0500P-N2 MAG LAYERS
L1208	6200J000013	MLB-321611-0500P-N2 MAG LAYERS
L1209	6200J000013	MLB-321611-0500P-N2 MAG LAYERS
L121	6200J000013	MLB-321611-0500P-N2 MAG LAYERS
L122	6210VC0005A	BK2125 HS 750 2X1.25X0.85MM R/TP
L123	6210VC0005A	BK2125 HS 750 2X1.25X0.85MM R/TP
L124	6210VC0005A	BK2125 HS 750 2X1.25X0.85MM R/TP
L125	6210VC0005A	BK2125 HS 750 2X1.25X0.85MM R/TP

LOCA. NO	PART NO	DESCRIPTION
L126	6210VC0005A	BK2125 HS 750 2X1.25X0.85MM R/TP
L202	6200J000013	MLB-321611-0500P-N2 MAG LAYERS
L203	6200J000013	MLB-321611-0500P-N2 MAG LAYERS
L204	6200J000013	MLB-321611-0500P-N2 MAG LAYERS
L300	6200J000013	MLB-321611-0500P-N2 MAG LAYERS
L301	6200J000013	MLB-321611-0500P-N2 MAG LAYERS
L302	6200JB8010L	MLB-201209-1000L-N2 MAG LAYERS
L400	6200J000013	MLB-321611-0500P-N2 MAG LAYERS
L401	6200J000013	MLB-321611-0500P-N2 MAG LAYERS
L402	6200J000013	MLB-321611-0500P-N2 MAG LAYERS
L403	6200J000013	MLB-321611-0500P-N2 MAG LAYERS
L408	6200J000013	MLB-321611-0500P-N2 MAG LAYERS
L408	6200JB8010L	MLB-201209-1000L-N2 MAG LAYERS
L409	6200J000013	MLB-321611-0500P-N2 MAG LAYERS
L409	6200JB8010L	MLB-201209-1000L-N2 MAG LAYERS
L410	6200J000013	MLB-321611-0500P-N2 MAG LAYERS
L500	6200J000013	MLB-321611-0500P-N2 MAG LAYERS
L502	6200JB8010L	MLB-201209-1000L-N2 MAG LAYERS
L503	6200JB8010L	MLB-201209-1000L-N2 MAG LAYERS
L506	6200J000013	MLB-321611-0500P-N2 MAG LAYERS
L604	6200J000013	MLB-321611-0500P-N2 MAG LAYERS
X1200	6212AB2845A	RESONATOR,CRYSTALABLS-27.000MHZ
X300	166-E02F	RESONATOR,CERAMICCSBLA500KECF09-B0
X400	156-A02M	RESONATOR,CRYSTALHC49U 18.432MHZ
X800	6212AB2844A	RESONATOR,CRYSTALABLS-19.6608MHZ
JACK		
JK100	6612J00043C	UPJ-R1-031 UGCOM S/T,SCART,SHIELD,SPRING
JK101	6612J00043C	UPJ-R1-031 UGCOM S/T,SCART,SHIELD,SPRING
JK101	6613V00026A	UJB-03-28A UGCOM
JK102	6612J00043C	UPJ-R1-031 UGCOM S/T,SCART,SHIELD,SPRING
JK103	6612J10012A	UJB-05-02C UGCOM COMPONENT
JK104	6612J00038B	UJB-03-25B UGCOM 6612J00038A+RED
JK1200	6612B00015B	DC1R019WDH JAE 0.5MM,19PIN+2PIN,HDMI S/T
JK400	6612J00037A	UJB-02-12A UGCOM 2P RCA VERTICAL+SHIELD
JK502	6612F00087A	UEJ-CV-032 UGCOM EAR JACK 10MM
JK600	6612F00087A	UEJ-CV-032 UGCOM EAR JACK 10MM
ACCESSORIES		
A1	3828VA0541F	MANUAL,OWNERS MF056C EU/42PX3RVA
A2	6710V00138M	REMOTE CONTROLLER, RZ-42PX30 SPEC.
A3	6410VEH003C	POWER CORD, M2511A-001 VDE/SEMKO 2800MM
MISCELLANEOUS		
C1	6850VA0004J	CABLE,COAXIAL UL1365#26 150MM UCA-EX-069
C2	6850J00005B	CABLE,DVI LVDS UL20276 AWG30 500MM
JK500	6630G70016A	CONNECTOR, A03-7071-094 SPG 15P 2.29MM RGB
JK601	6630G70017A	CONNECTOR, A02-0915-101 SPG 9P 2.54MM
PA101	6712000002B	REMOTE CONTROLLER RECEIVER,KSM-603SM12E-1
TU201	6700MF0010A	TUNER, TAUM-W501P MINI 4 SYSTEM MAIN

4. AUDIO BLOCK

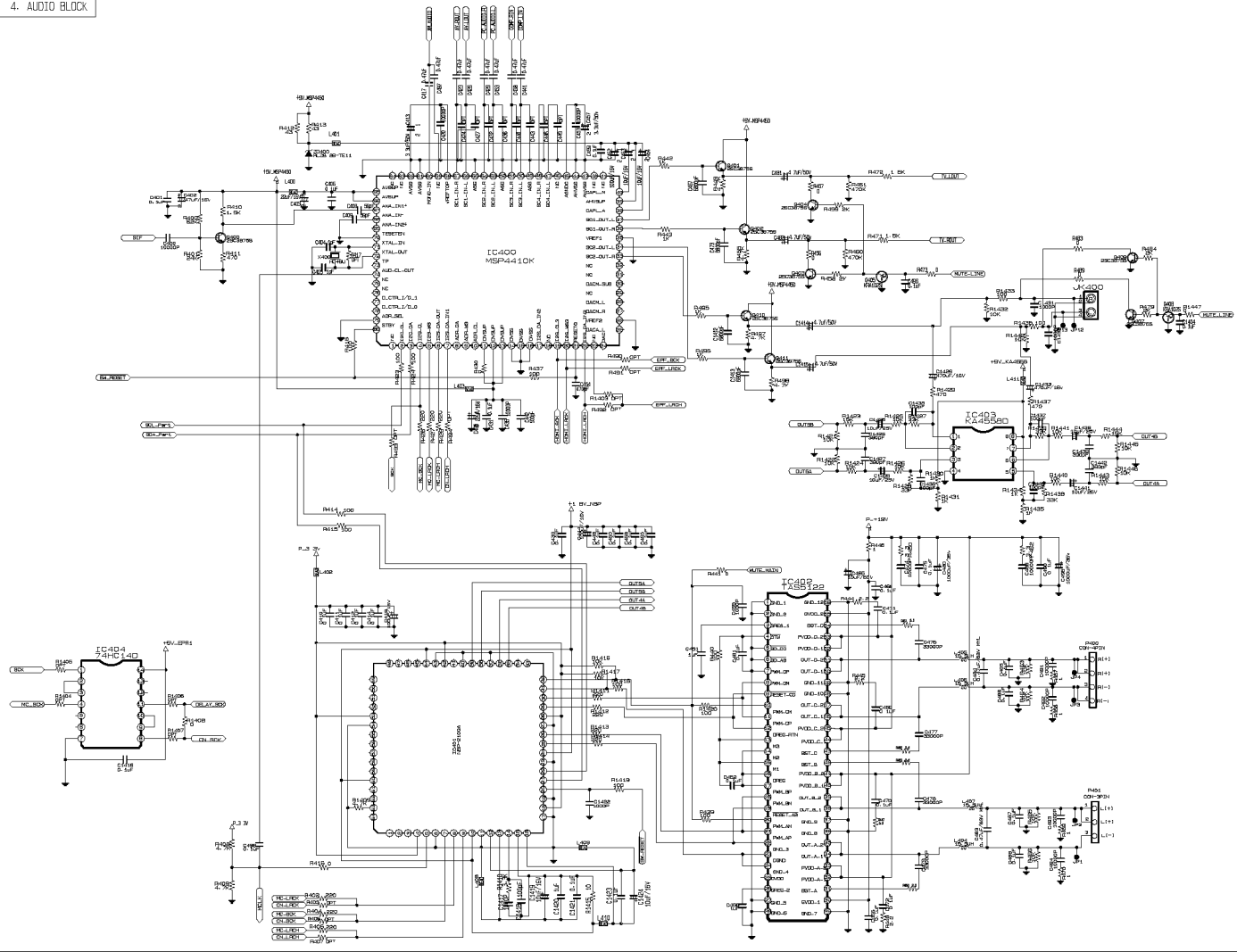

10. POWER

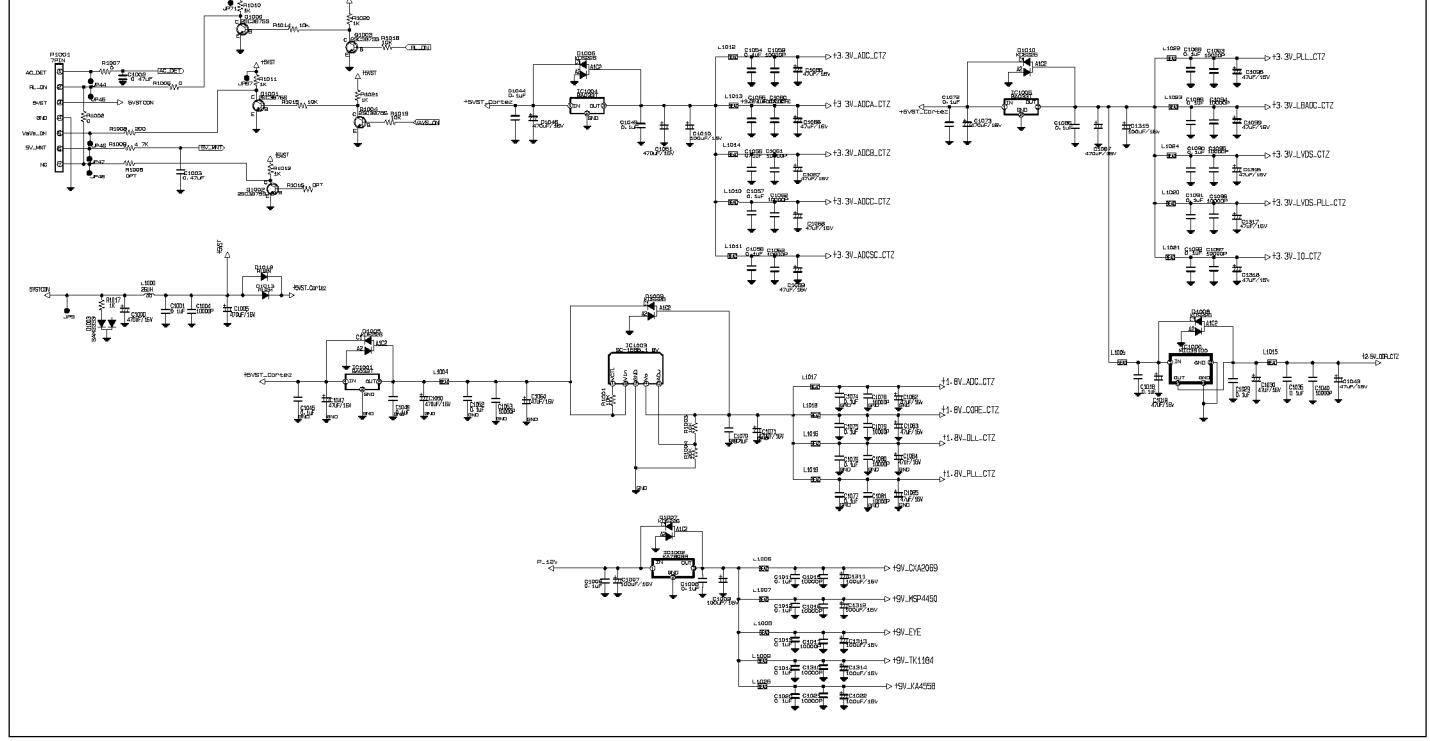

5. RGB INPUT

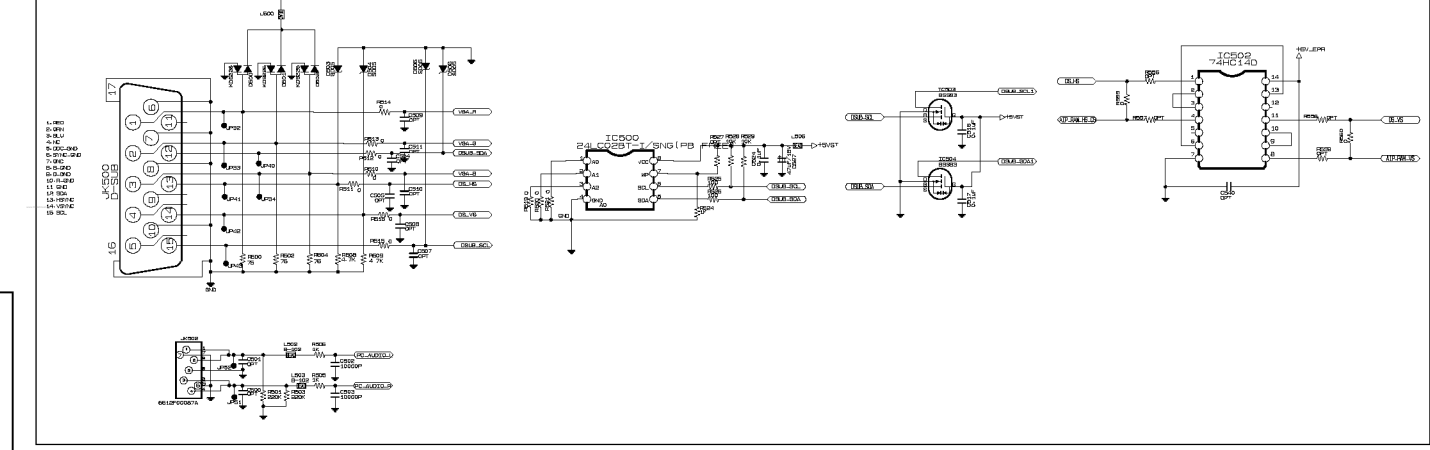

9. DDR MEMORY

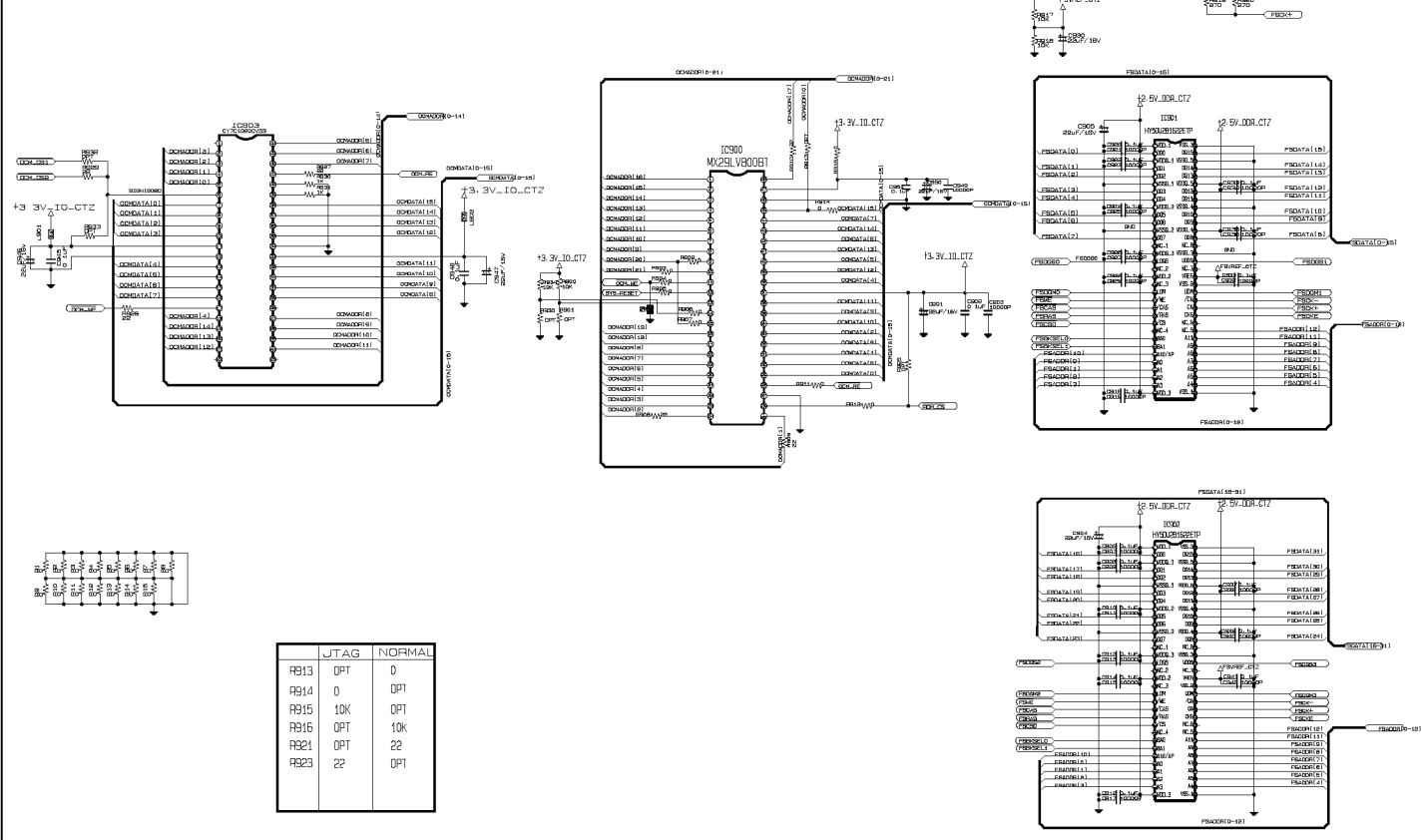

6. PS232C & FAN

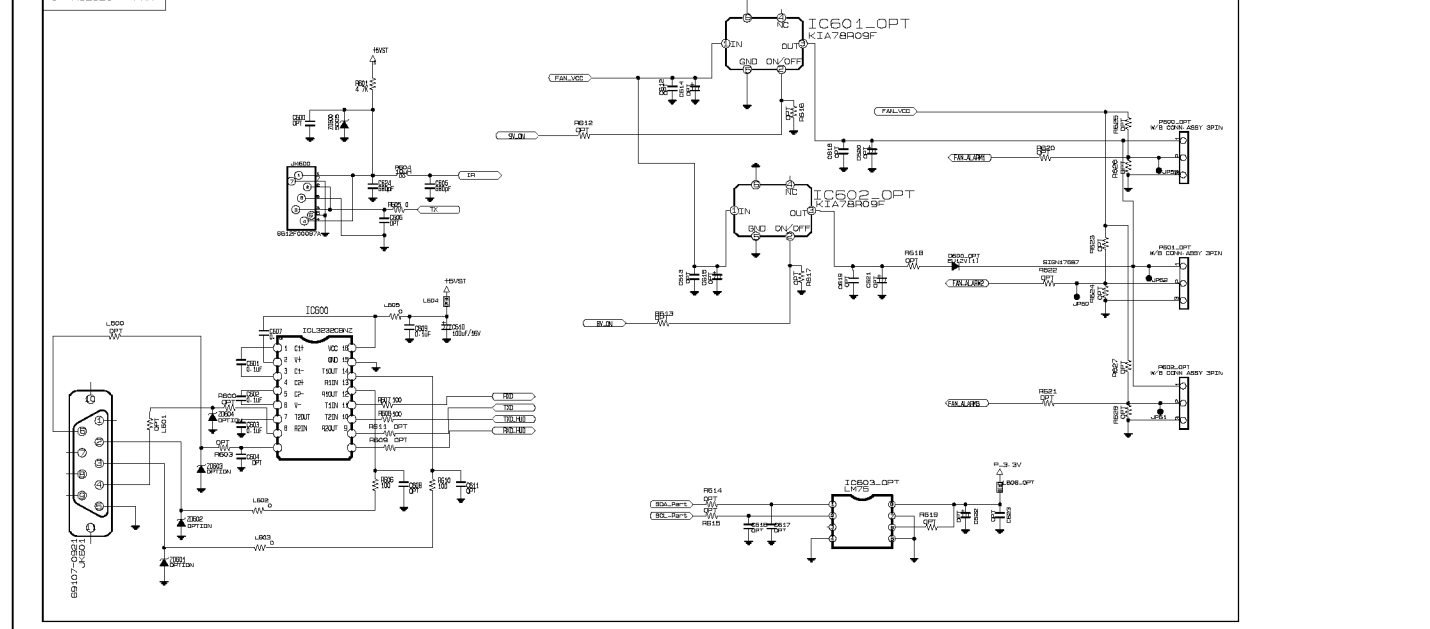

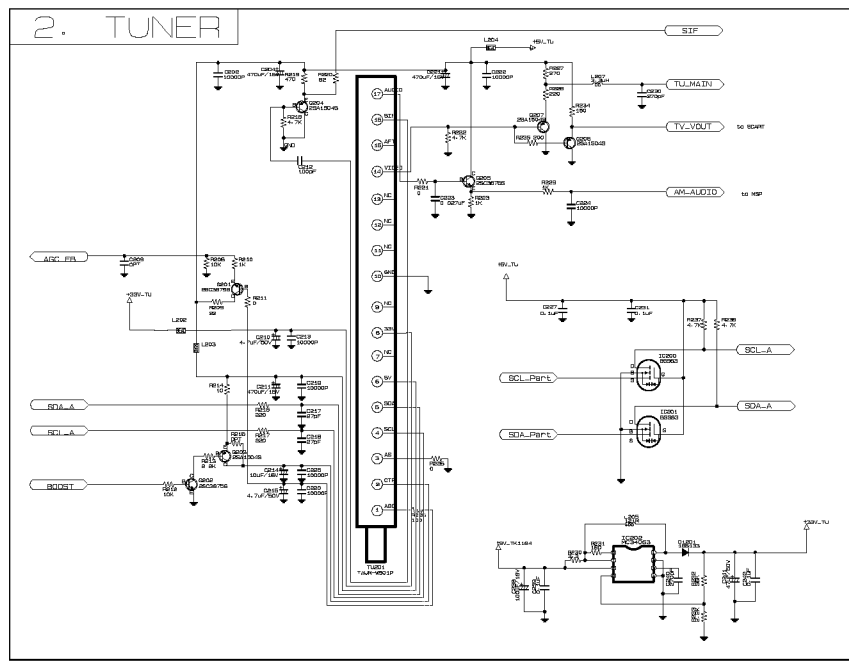
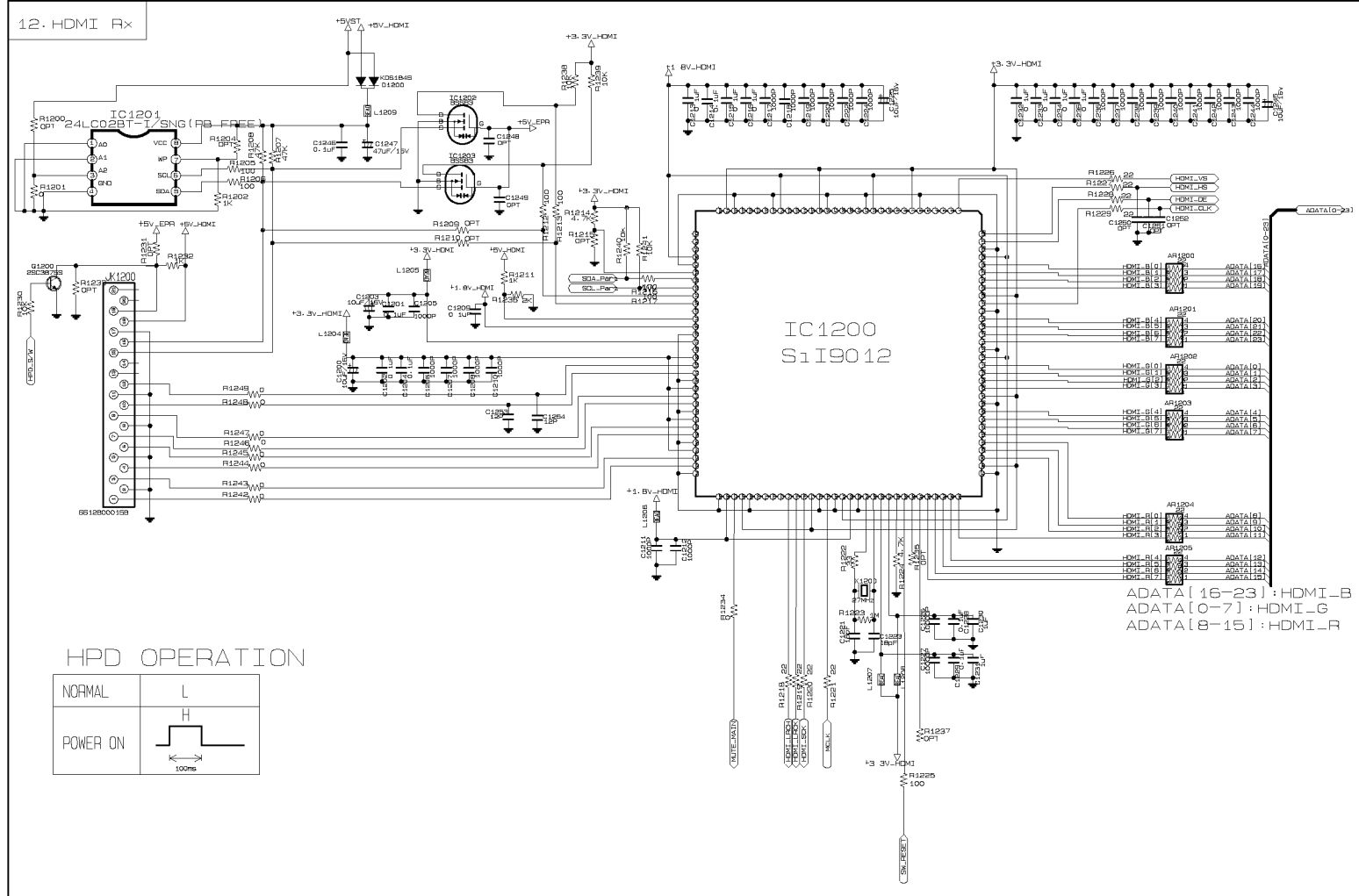



P/NO : 3828VD0209N

Mar., 2005
Printed in Korea

