

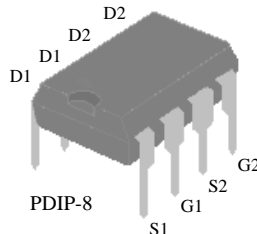

- ▼ Low Gate Charge
- ▼ Fast Switching Speed
- ▼ PDIP-8 Package



N-CH	BV_{DSS}	35V
	$R_{DS(ON)}$	25m Ω
	I_D	7A
P-CH	BV_{DSS}	-35V
	$R_{DS(ON)}$	40m Ω
	I_D	-6.1A

Description

Advanced Power MOSFETs from APEC provide the designer with the best combination of fast switching, ruggedized device design, ultra low on-resistance and cost-effectiveness.

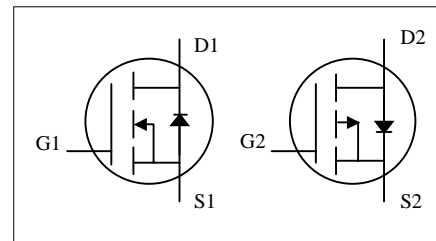

Absolute Maximum Ratings

Symbol	Parameter	Rating		Units
		N-channel	P-channel	
V_{DS}	Drain-Source Voltage	35	-35	V
V_{GS}	Gate-Source Voltage	± 20	± 20	V
$I_D @ T_A = 25^\circ C$	Continuous Drain Current ³	7	-6.1	A
$I_D @ T_A = 70^\circ C$	Continuous Drain Current ³	5.7	-5	A
I_{DM}	Pulsed Drain Current ¹	30	-30	A
$P_D @ T_A = 25^\circ C$	Total Power Dissipation	2.0		W
	Linear Derating Factor	0.016		W/ $^\circ C$
T_{STG}	Storage Temperature Range	-55 to 150		$^\circ C$
T_J	Operating Junction Temperature Range	-55 to 150		$^\circ C$

Thermal Data

Symbol	Parameter	Value	Unit
Rthj-a	Maximum Thermal Resistance, Junction-ambient ³	62.5	$^\circ C/W$



N-CH Electrical Characteristics @T_j=25°C(unless otherwise specified)

Symbol	Parameter	Test Conditions	Min.	Typ.	Max.	Units
BV _{DSS}	Drain-Source Breakdown Voltage	V _{GS} =0V, I _D =250uA	35	-	-	V
ΔBV _{DSS} /ΔT _j	Breakdown Voltage Temperature Coefficient	Reference to 25°C, I _D =1mA	-	0.02	-	V/°C
R _{DS(ON)}	Static Drain-Source On-Resistance ²	V _{GS} =10V, I _D =7A	-	20	25	mΩ
		V _{GS} =4.5V, I _D =5A	-	30	37	mΩ
V _{GS(th)}	Gate Threshold Voltage	V _{DS} =V _{GS} , I _D =250uA	1	-	3	V
g _{fs}	Forward Transconductance	V _{DS} =10V, I _D =7A	-	9	-	S
I _{DSS}	Drain-Source Leakage Current	V _{DS} =35V, V _{GS} =0V	-	-	1	uA
	Drain-Source Leakage Current (T _j =70°C)	V _{DS} =28V, V _{GS} =0V	-	-	25	uA
I _{GSS}	Gate-Source Leakage	V _{GS} =±20V	-	-	±100	nA
Q _g	Total Gate Charge ²	I _D =7A V _{DS} =28V V _{GS} =4.5V	-	11	18	nC
Q _{gs}	Gate-Source Charge		-	3	-	nC
Q _{gd}	Gate-Drain ("Miller") Charge		-	6	-	nC
t _{d(on)}	Turn-on Delay Time ²	V _{DS} =18V	-	12	-	ns
t _r	Rise Time	I _D =1A	-	7	-	ns
t _{d(off)}	Turn-off Delay Time	R _G =3.3Ω, V _{GS} =10V	-	22	-	ns
t _f	Fall Time	R _D =18Ω	-	6	-	ns
C _{iss}	Input Capacitance	V _{GS} =0V	-	830	1330	pF
C _{oss}	Output Capacitance	V _{DS} =25V	-	150	-	pF
C _{rss}	Reverse Transfer Capacitance	f=1.0MHz	-	110	-	pF
R _g	Gate Resistance	f=1.0MHz	-	1.2	1.8	Ω

Source-Drain Diode

Symbol	Parameter	Test Conditions	Min.	Typ.	Max.	Units
V _{SD}	Forward On Voltage ²	I _S =1.7A, V _{GS} =0V	-	-	1.2	V
t _{rr}	Reverse Recovery Time ²	I _S =7A, V _{GS} =0V dI/dt=100A/μs	-	18	-	ns
Q _{rr}	Reverse Recovery Charge		-	12	-	nC



P-CH Electrical Characteristics @T_j=25°C(unless otherwise specified)

Symbol	Parameter	Test Conditions	Min.	Typ.	Max.	Units
BV _{DSS}	Drain-Source Breakdown Voltage	V _{GS} =0V, I _D =-250uA	-35	-	-	V
ΔBV _{DSS} /ΔT _j	Breakdown Voltage Temperature Coefficient	Reference to 25°C, I _D =-1mA	-	-0.02	-	V/°C
R _{DS(ON)}	Static Drain-Source On-Resistance ²	V _{GS} =-10V, I _D =-6A	-	35	40	mΩ
		V _{GS} =-4.5V, I _D =-4A	-	53	60	mΩ
V _{GS(th)}	Gate Threshold Voltage	V _{DS} =V _{GS} , I _D =-250uA	-1	-	-3	V
g _{fs}	Forward Transconductance	V _{DS} =-10V, I _D =-6A	-	9	-	S
I _{DSS}	Drain-Source Leakage Current	V _{DS} =-35V, V _{GS} =0V	-	-	-1	uA
	Drain-Source Leakage Current (T=70°C)	V _{DS} =-28V, V _{GS} =0V	-	-	-25	uA
I _{GSS}	Gate-Source Leakage	V _{GS} =±20V	-	-	±100	nA
Q _g	Total Gate Charge ²	I _D =-6A	-	10	16	nC
Q _{gs}	Gate-Source Charge	V _{DS} =-28V	-	2	-	nC
Q _{gd}	Gate-Drain ("Miller") Charge	V _{GS} =-4.5V	-	6	-	nC
t _{d(on)}	Turn-on Delay Time ²	V _{DS} =-18V	-	10	-	ns
t _r	Rise Time	I _D =-1A	-	6	-	ns
t _{d(off)}	Turn-off Delay Time	R _G =3.3Ω, V _{GS} =-10V	-	26	-	ns
t _f	Fall Time	R _D =18Ω	-	7	-	ns
C _{iss}	Input Capacitance	V _{GS} =0V	-	690	1100	pF
C _{oss}	Output Capacitance	V _{DS} =-25V	-	165	-	pF
C _{rss}	Reverse Transfer Capacitance	f=1.0MHz	-	130	-	pF
R _g	Gate Resistance	f=1.0MHz	-	5.2	7.8	Ω

Source-Drain Diode

Symbol	Parameter	Test Conditions	Min.	Typ.	Max.	Units
V _{SD}	Forward On Voltage ²	I _S =-1.7A, V _{GS} =0V	-	-	-1.2	V
t _{rr}	Reverse Recovery Time ²	I _S =-6A, V _{GS} =0V	-	20	-	ns
Q _{rr}	Reverse Recovery Charge	dI/dt=-100A/μs	-	12	-	nC

Notes:

- 1.Pulse width limited by Max. junction temperature.
- 2.Pulse test
- 3.Surface mounted on 1 in² copper pad of FR4 board , t ≤10sec ; 90°C/W when mounted on min. copper pad.

THIS PRODUCT IS SENSITIVE TO ELECTROSTATIC DISCHARGE, PLEASE HANDLE WITH CAUTION.

USE OF THIS PRODUCT AS A CRITICAL COMPONENT IN LIFE SUPPORT OR OTHER SIMILAR SYSTEMS IS NOT AUTHORIZED.

APEC DOES NOT ASSUME ANY LIABILITY ARISING OUT OF THE APPLICATION OR USE OF ANY PRODUCT OR CIRCUIT DESCRIBED HEREIN; NEITHER DOES IT CONVEY ANY LICENSE UNDER ITS PATENT RIGHTS, NOR THE RIGHTS OF OTHERS.

APEC RESERVES THE RIGHT TO MAKE CHANGES WITHOUT FURTHER NOTICE TO ANY PRODUCTS HEREIN TO IMPROVE RELIABILITY, FUNCTION OR DESIGN.



AP4511GD

N-Channel

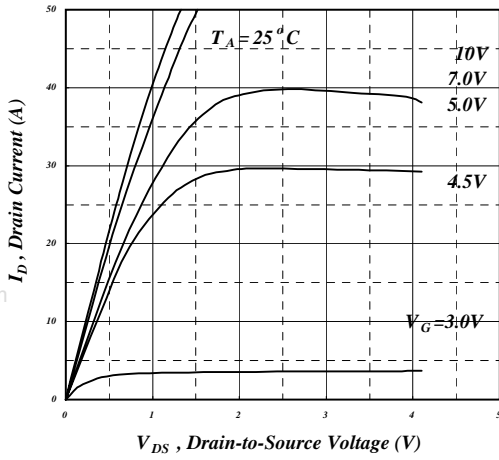

Fig 1. Typical Output Characteristics

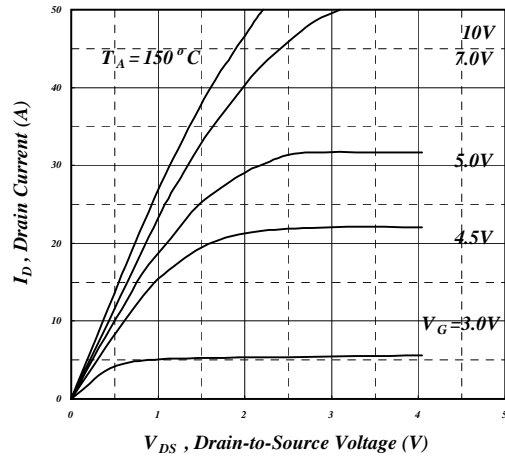

Fig 2. Typical Output Characteristics

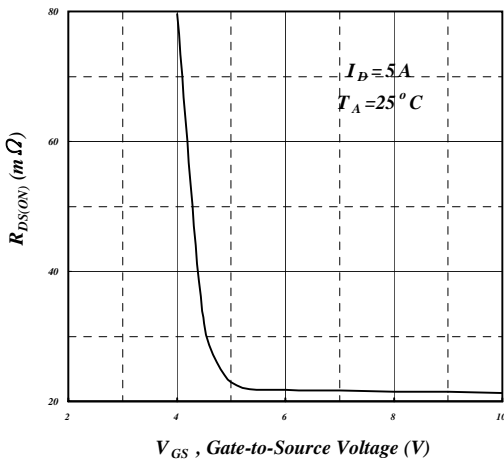

Fig 3. On-Resistance v.s. Gate Voltage

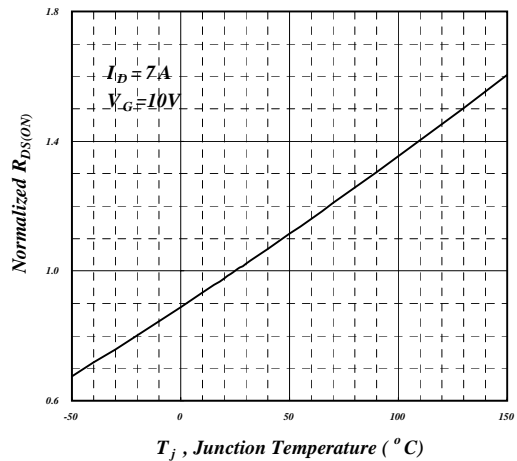

Fig 4. Normalized On-Resistance v.s. Junction Temperature

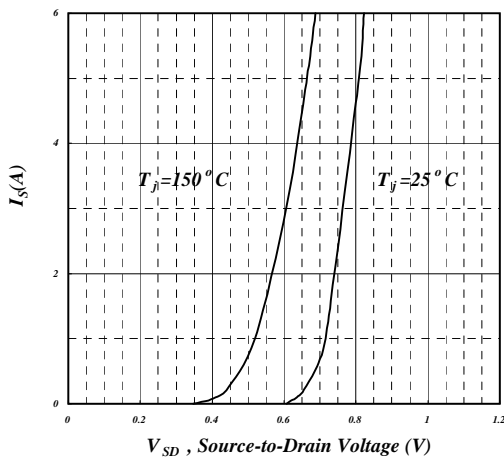

Fig 5. Forward Characteristic of Reverse Diode

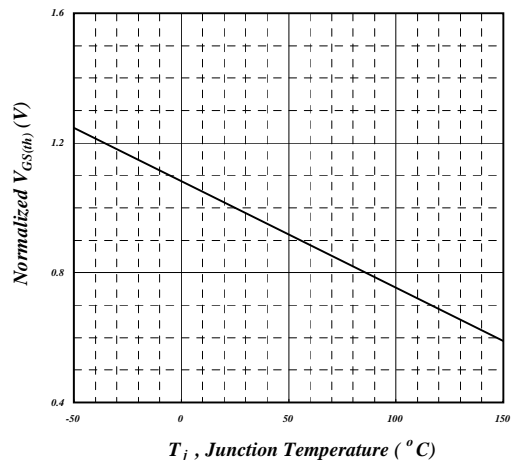

Fig 6. Gate Threshold Voltage v.s. Junction Temperature



N-Channel

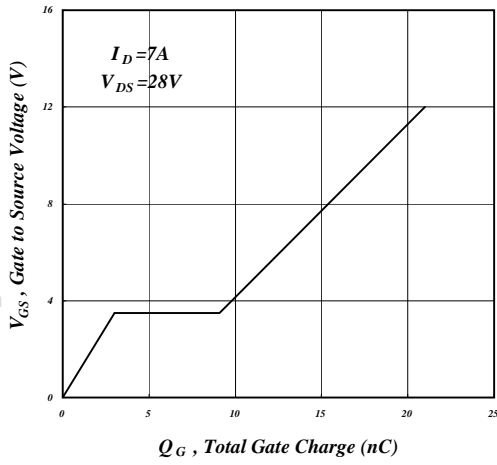

Fig 7. Gate Charge Characteristics

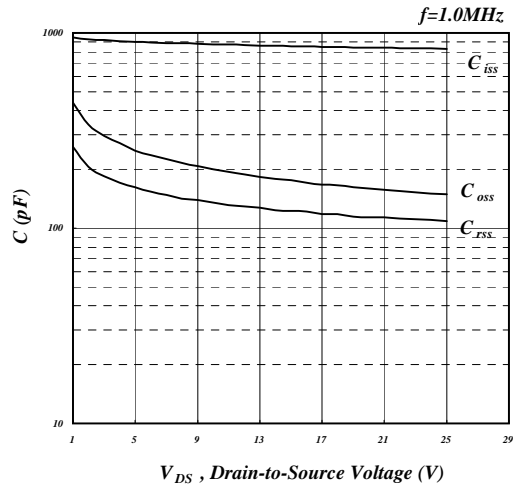

Fig 8. Typical Capacitance Characteristics

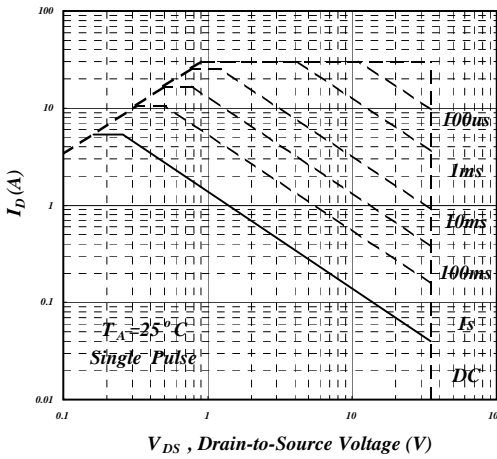

Fig 9. Maximum Safe Operating Area

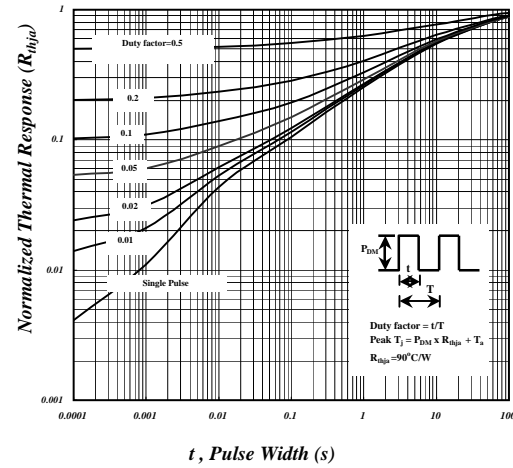

Fig 10. Effective Transient Thermal Impedance

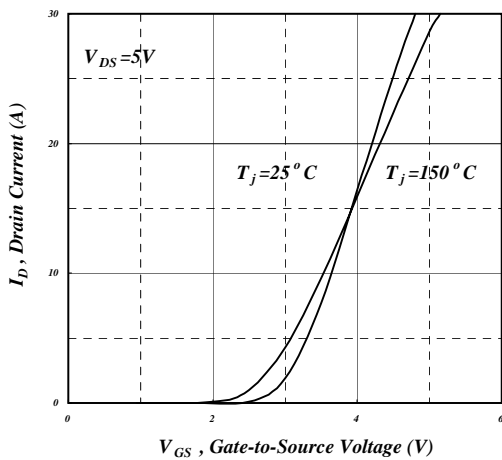

Fig 11. Transfer Characteristics

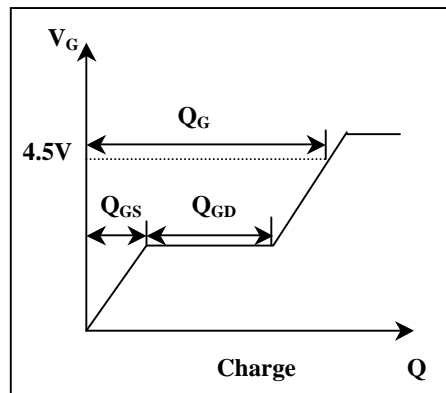

Fig 12. Gate Charge Waveform



AP4511GD

P-Channel

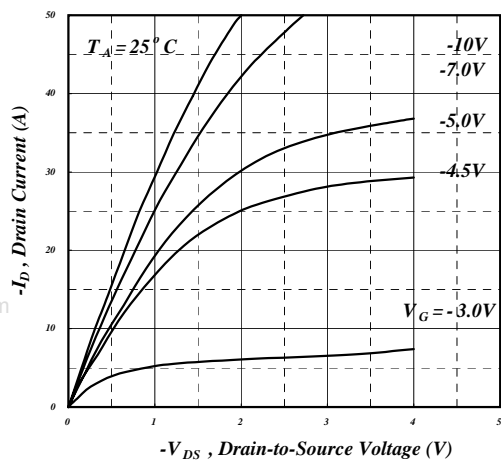

Fig 1. Typical Output Characteristics

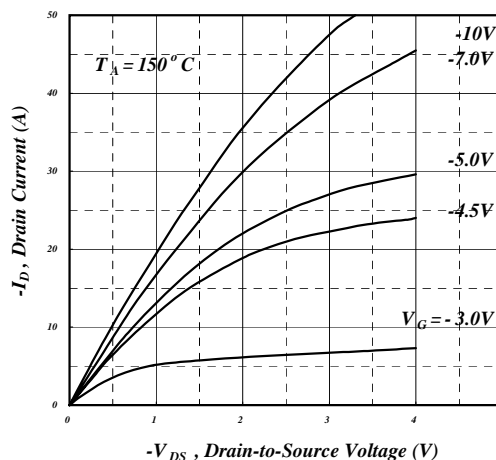

Fig 2. Typical Output Characteristics

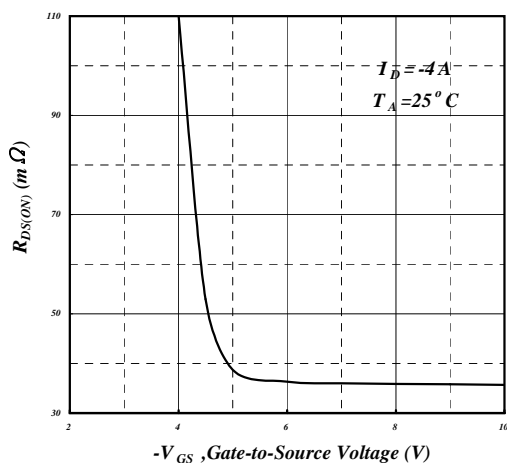

Fig 3. On-Resistance v.s. Gate Voltage

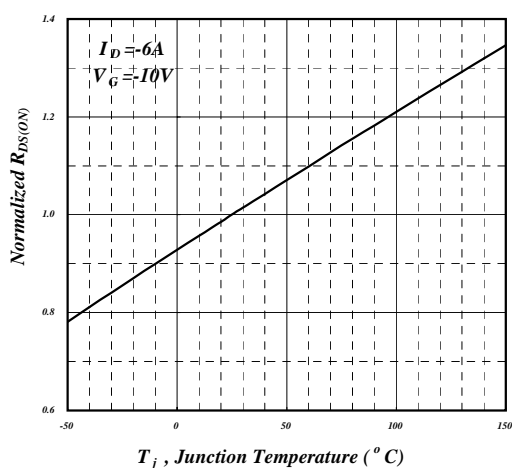

Fig 4. Normalized On-Resistance v.s. Junction Temperature

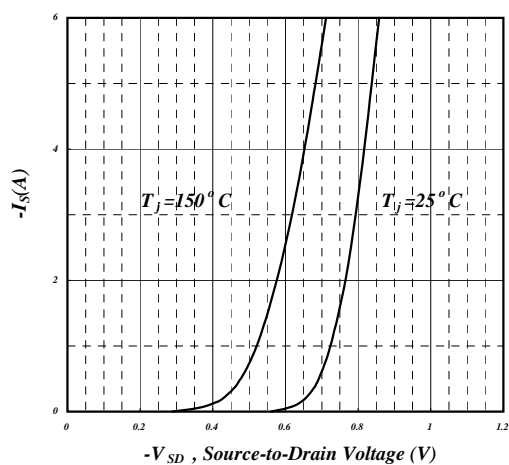

Fig 5. Forward Characteristic of Reverse Diode

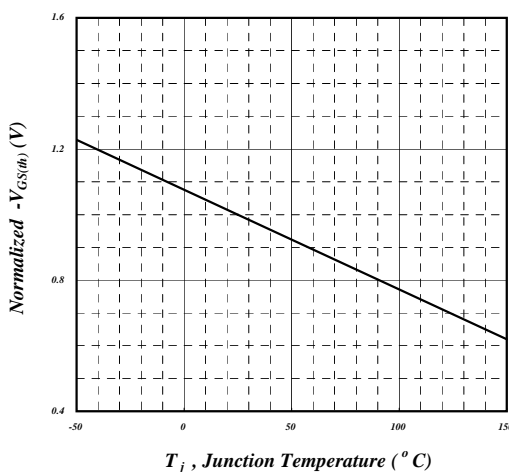

Fig 6. Gate Threshold Voltage v.s. Junction Temperature



P-Channel

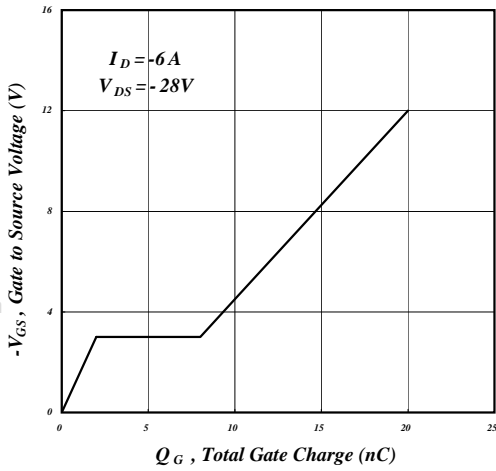

Fig 7. Gate Charge Characteristics

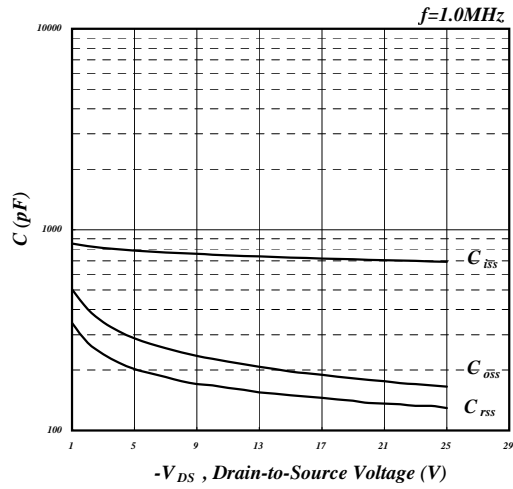

Fig 8. Typical Capacitance Characteristics

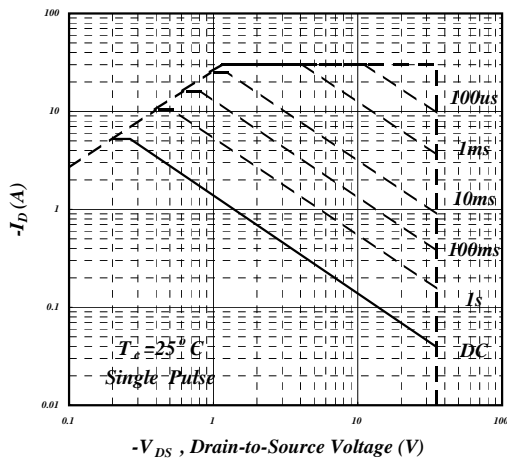

Fig 9. Maximum Safe Operating Area

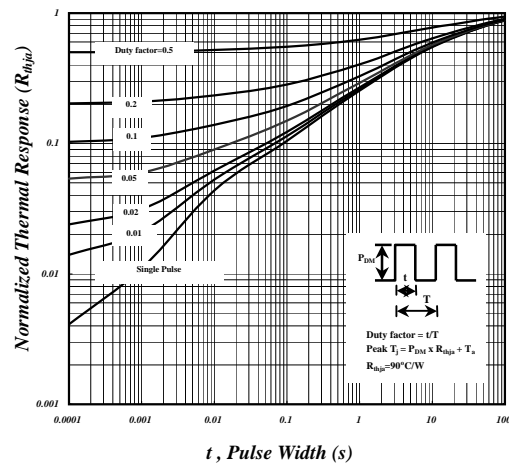

Fig 10. Effective Transient Thermal Impedance

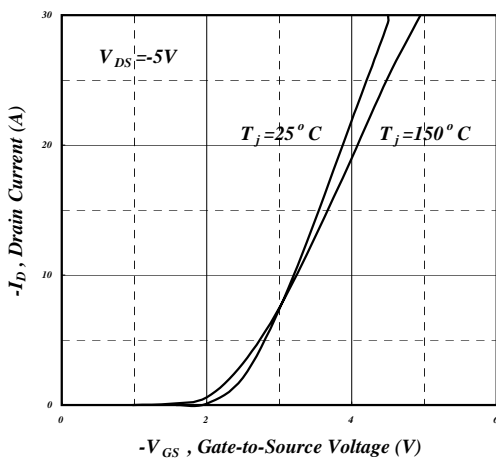

Fig 11. Transfer Characteristics

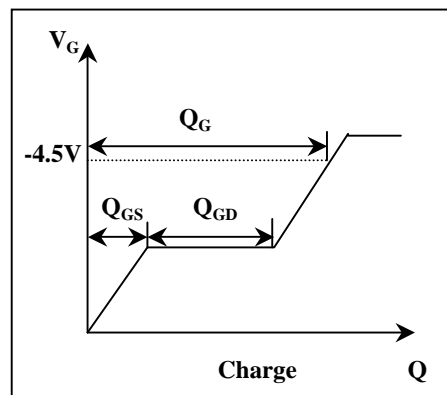
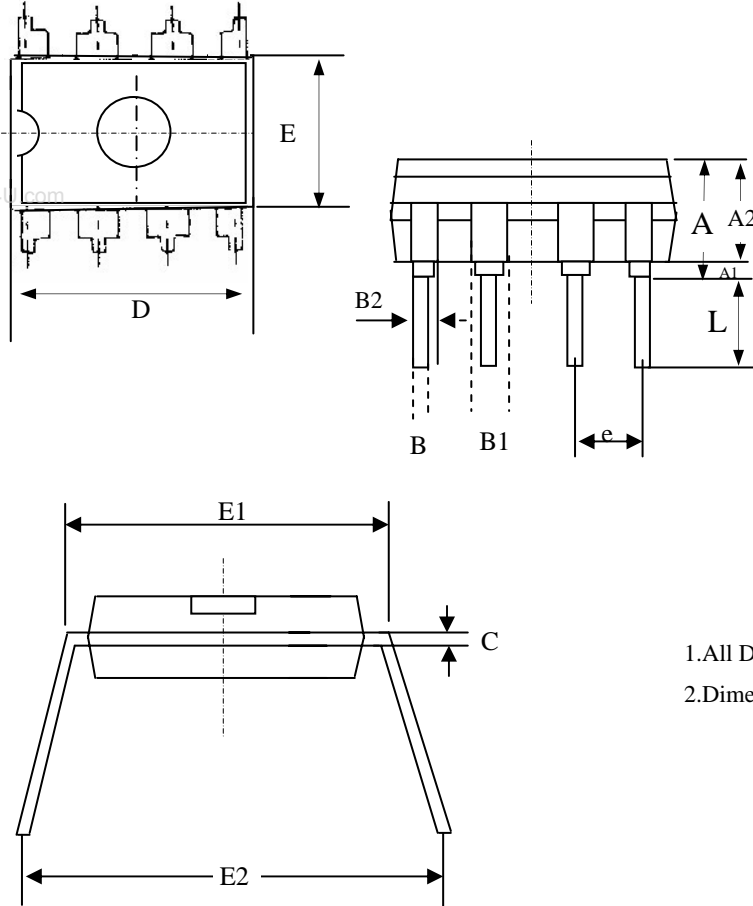

Fig 12. Gate Charge Waveform



ADVANCED POWER ELECTRONICS CORP.

Package Outline : DIP-8



SYMBOLS	Millimeters		
	MIN	NOM	MAX
A	3.60	4.50	5.40
A1	0.38	----	----
A2	2.90	3.95	5.00
B	0.36	0.46	0.56
B1	1.10	1.45	1.80
B2	0.76	0.98	1.20
C	0.20	0.28	0.36
D	9.00	9.60	10.20
E	6.10	6.65	7.20
E1	7.62	7.94	8.26
E2	8.30	9.65	11.00
e	2.540 BSC		
L	3.18	----	----

1. All Dimensions Are in Millimeters.
2. Dimension Does Not Include Mold Protrusions.

Part Marking Information & Packing : DIP-8

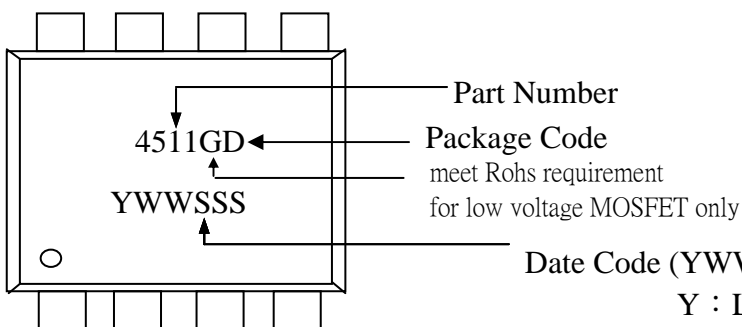

Y : Last Digit Of The Year
 WW : Week
 SSS : Sequence